

3A, 1MHz, 6V CMCOT Synchronous Step-Down Converter

General Description

The RT5797A is a high efficiency synchronous step-down DC-DC converter. Its input voltage range is from 2.7V to 6V and provides an adjustable regulated output voltage from 0.6V to 3.4V while delivering up to 3A of output current.

The internal synchronous low on-resistance power switches increase efficiency and eliminate the need for an external Schottky diode. The Current Mode Constant-On-time (CMCOT) operation with internal compensation allows the transient response to be optimized over a wide range of loads and output capacitors. The RT5797A is available in the WDFN-8L 2x2 and WDFN-8SL 2x2 packages.

The recommended junction temperature range is -40°C to 125°C , and the ambient temperature range is -40°C to 85°C .

Ordering Information

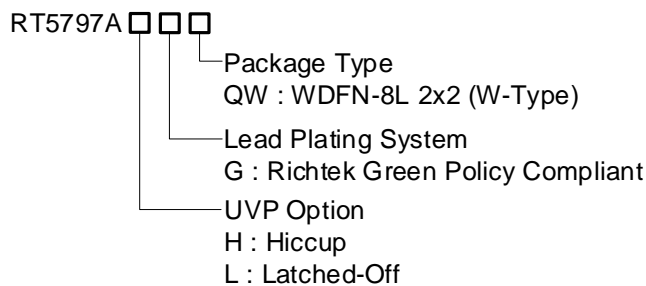

Features

- Efficiency Up to 95%
- $R_{DS(ON)}$ 100m Ω HS / 70m Ω LS
- V_{IN} Range 2.7V to 6V
- V_{REF} 0.6V with $\pm 1\%$ Accuracy at 25°C
- CMCOT™ Control Loop Design for Best Transient Response, Robust Loop Stability with Low-ESR (MLCC) C_{OUT}
- Soft-Start 1.2ms
- Power Saving in Light Load

Applications

- STB, Cable Modem, & xDSL Platforms
- LCD TV Power Supply & Metering Platforms
- General Purpose Point of Load (POL)

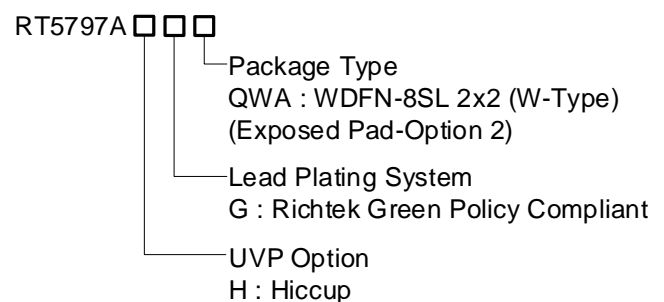

Note:

Richtek products are Richtek Green Policy compliant and compatible with the current requirements of IPC/JEDEC J-STD-020.

Simplified Application Circuit

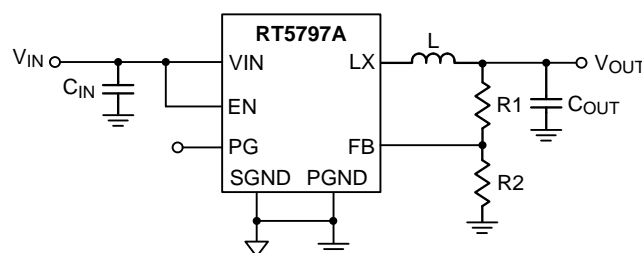

Pin Configuration

(TOP VIEW)

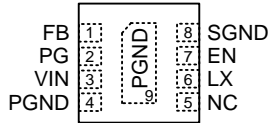

WDFN-8L 2x2 / WDFN-8SL 2x2

Marking Information

RT5797ALGQW

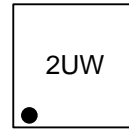

2U : Product Code
W : Date Code

RT5797AHGQW

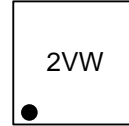

2V : Product Code
W : Date Code

RT5797AHGQWA

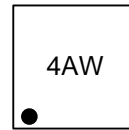

4A : Product Code
W : Date Code

Functional Pin Description

Pin No.	Pin Name	Pin Function
WDFN-8L 2x2 WDFN-8SL 2x2		
1	FB	Feedback voltage input. An external resistor divider from the output to GND, tapped to the FB pin, sets the output voltage.
2	PG	Power good indicator. The output of this pin is an open-drain with external pull-up resistor. PG is pulled up when the FB voltage is within 90%, otherwise it is LOW.
3	VIN	Supply voltage input. The RT5797A operates from a 2.7V to 6V input.
4, 9 (Exposed Pad)	PGND	Power ground. The exposed pad must be soldered to a large PCB and connected to PGND for maximum power dissipation.
5	NC	No internal connection.
6	LX	Switch node.
7	EN	Enable control input.
8	SGND	Signal GND.

Functional Block Diagram

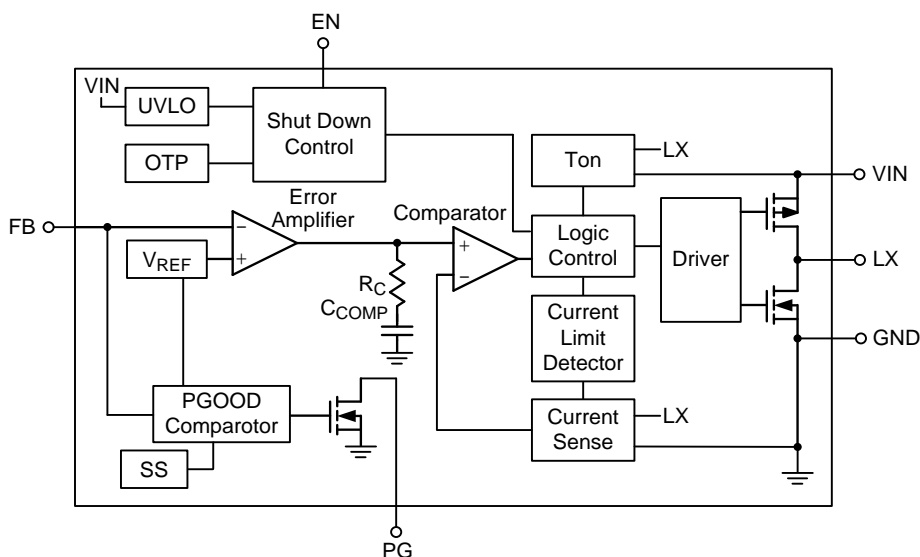

Operation

The RT5797A is a synchronous low voltage step-down converter that can support the input voltage range from 2.7V to 6V and the output current can be up to 3A. The RT5797A uses a constant on-time, current mode architecture. In normal operation, the high side P-MOSFET is turned on when the switch controller is set by the comparator and is turned off when the Ton comparator resets the switch controller.

Low side MOSFET peak current is measured by internal RSENSE. The error amplifier EA adjusts COMP voltage by comparing the feedback signal (V_{FB}) from the output voltage with the internal 0.6V reference. When the load current increases, it causes a drop in the feedback voltage relative to the reference, then the COMP voltage rises to allow higher inductor current to match the load current.

UV Comparator

If the feedback voltage (V_{FB}) is lower than threshold voltage 0.2V, the UV comparator's output will go high and the switch controller will turn off the high side MOSFET. The output under voltage protection is designed to operate in Hiccup mode for the RT5797AH, Latch mode for the RT5797AL.

Soft-Start (SS)

An internal current source charges an internal capacitor to build the soft-start ramp voltage. The V_{FB} voltage will

track the internal ramp voltage during soft-start interval. The typical soft-start time is 1.2ms.

PGOOD Comparator

When the feedback voltage (V_{FB}) is higher than threshold voltage 0.54V and the internal soft-start function has been finished, the PGOOD open drain output will be high impedance. The internal PG MOSFET is typical 20Ω. The PGOOD signal delay time is defined from EN high to the internal soft-start function end which is about 2ms (Typ.).

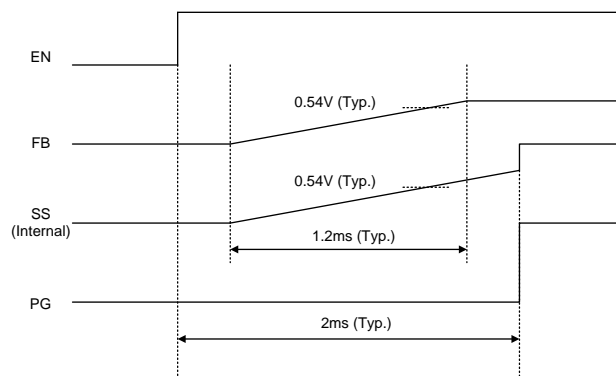

Enable Comparator

A logic-high enables the converter; a logic-low forces the IC into shutdown mode.

Over-Current Protection (OCP)

The RT5797A provides over-current protection by detecting low side MOSFET valley inductor current. If

the sensed valley inductor current is over the current limit threshold (3.7A typ.), the OCP will be triggered. When OCP is tripped, the RT5797A will keep the over current threshold level then cause the UV protection.

Thermal Shutdown (OTP)

The device implements an internal thermal shutdown function when the junction temperature exceeds 150°C. The thermal shutdown forces the device to stop switching when the junction temperature exceeds the thermal shutdown threshold. Once the die temperature decreases below the hysteresis of 20°C, the device reinstates the power up sequence.

Maximum Duty Cycle

The maximum duty cycle (70%, min.) can be calculated by minimum off time (180ns, max.), dead time (60ns, max.) and switching frequency (1.2MHz, max.).

$$D_{MAX} = 1 - (t_{OFF_MIN} + t_D) \times f_{SW}$$

Where t_{OFF_MIN} is minimum off time, t_D is dead time and f_{SW} is switching frequency.

If input voltage and output voltage are closed, RT5797A operates at high duty cycle. Once the operational duty cycle is larger than the maximum duty cycle (70%, min.), RT5797A keeps minimum off time (180ns, max.) and deadtime (60ns, max.), then the output voltage starts to drop. The input voltage at which the devices enter dropout changes depending on the input voltage, output voltage, switching frequency, load current, and the efficiency of the design.

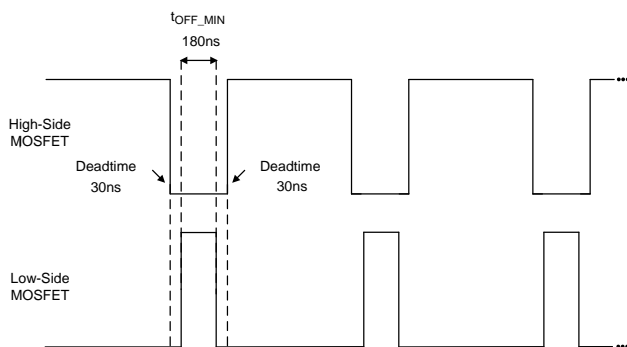

Absolute Maximum Ratings (Note 1)

- Supply Input Voltage ----- -0.3V to 6.5V
- VIN to SW ----- -0.3V to 6.5V
- VIN to SW (t ≤ 10ns) ----- -4.5V to 9V
- Switch Voltage, SW ----- -0.3V to 6.5V
SW (t ≤ 10ns) ----- -4.5V to 9V
- Others Pins ----- -0.3V to 6.5V
- Power Dissipation, PD @ TA = 25°C
WDFN-8L 2x2 ----- 2.19W
WDFN-8SL 2x2 ----- 2.19W
- Package Thermal Resistance (Note 2)
WDFN-8L 2x2, θJA ----- 45.5°C/W
WDFN-8SL 2x2, θJA ----- 45.6°C/W
- Lead Temperature (Soldering, 10 sec.) ----- 260°C
- Junction Temperature ----- -40°C to 150°C
- Storage Temperature Range ----- -65°C to 150°C
- ESD Susceptibility (Note 3)
HBM (Human Body Model) ----- 2kV

Recommended Operating Conditions (Note 4)

- Supply Input Voltage ----- 2.7V to 6V
- Ambient Temperature Range ----- -40°C to 85°C
- Junction Temperature Range ----- -40°C to 125°C

Electrical Characteristics

(VIN = 3.6V, TA = 25°C, unless otherwise specified)

Parameter	Symbol	Test Conditions	Min	Typ	Max	Unit
Input Voltage	VIN		2.7	--	6	V
Feedback Reference Voltage	VREF		0.594	0.6	0.606	V
Feedback Leakage Current	IFB	VFB = 0.6V	--	--	0.1	μA
DC Bias Current		Active, VFB = 0.63V, not switching	--	22	36	μA
		Shutdown	--	--	1	
Switching Leakage Current			--	--	1	μA
Switching Frequency			0.8	1	1.2	MHz
Switch On Resistance, Low	RNMOS	ISW = 0.3A	--	70	85	mΩ
Switch On Resistance, High	RP MOS	ISW = 0.3A	--	100	125	mΩ
Valley Current Limit	ILIM		3.03	3.7	4.6	A

Parameter	Symbol	Test Conditions	Min	Typ	Max	Unit	
Under-Voltage Lockout Threshold	V _{UVLO}	VDD rising	--	2.25	2.5	V	
		VDD falling	--	2	--	V	
Over-Temperature Threshold			--	150	--	°C	
Enable Threshold Voltage	H-Level	VENH	EN rising	0.7	0.85	1.05	V
	L-Level	VENL	EN falling	0.5	0.75	0.95	
PG Pin Threshold (relative to V _{OUT})		Rising	85	90	95	%	
		Falling	80	85	90		
PG Open-Drain Impedance (PG = low)			--	--	20	Ω	
Soft-Start Time	t _{SS}		0.5	1.2	2	ms	
Minimum Off Time	t _{OFF_MIN}		70	120	180	ns	
Maximum Duty Cycle	D _{MAX}	(Note 5)	70	--	--	%	
Output Discharge Switch On Resistance			1.2	1.8	2.4	kΩ	
Over-Voltage Protection (relative to V _{OUT})	V _{OV} P	Rising	115	120	125	%	

Note 1. Stresses beyond those listed under “Absolute Maximum Ratings” may cause permanent damage to the device. These are stress ratings only, and functional operation of the device at these or any other conditions beyond those indicated in the operational sections of the specifications is not implied. Exposure to absolute maximum rating conditions may affect device reliability.

Note 2. θ_{JA} is measured under natural convection (still air) at $T_A = 25^\circ\text{C}$ with the component mounted on a high effective-thermal-conductivity four-layer test board on a JEDEC 51-7 thermal measurement standard.

Note 3. Devices are ESD sensitive. Handling precautions are recommended.

Note 4. The device is not guaranteed to function outside its operating conditions.

Note 5. Guaranteed by design.

Typical Application Circuit

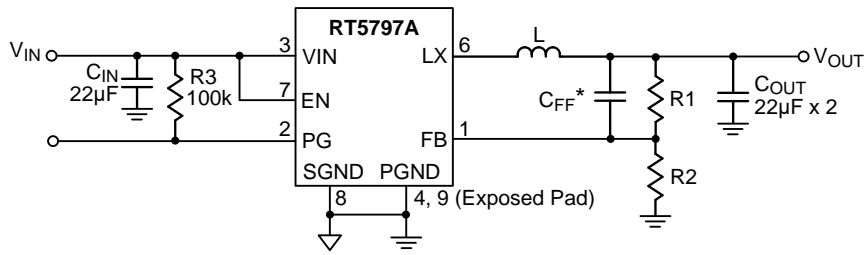

*CFF : Optional for performance fine-tune

Table 1. Suggested Component Values

Vout (V)	R1 (kΩ)	R2 (kΩ)	CIN (µF)	L (µH)	COUT (µF)
3.3	90	20	22	1.5	22 x2
1.8	100	50	22	1.5	22 x2
1.5	100	66.6	22	1.5	22 x2
1.2	100	100	22	1.5	22 x2
1.05	100	133	22	1.5	22 x2
1	100	148	22	1.5	22 x2

Typical Operating Characteristics

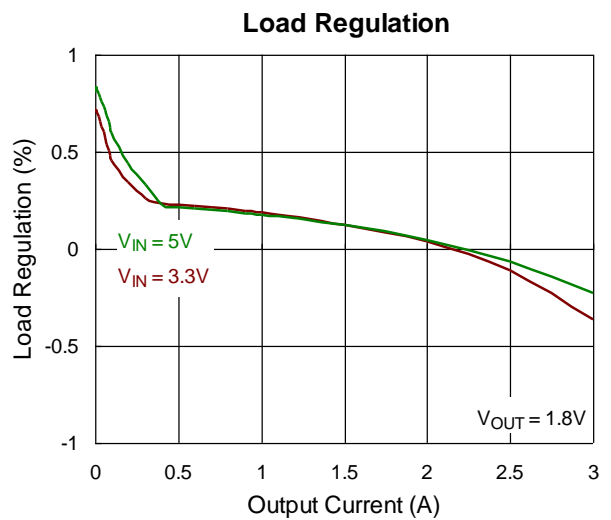
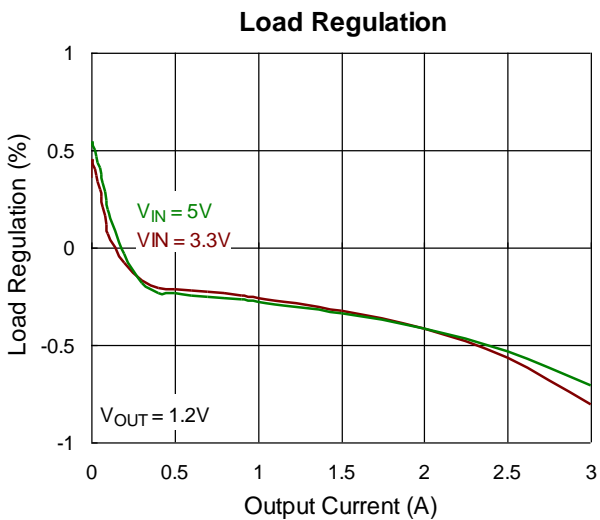
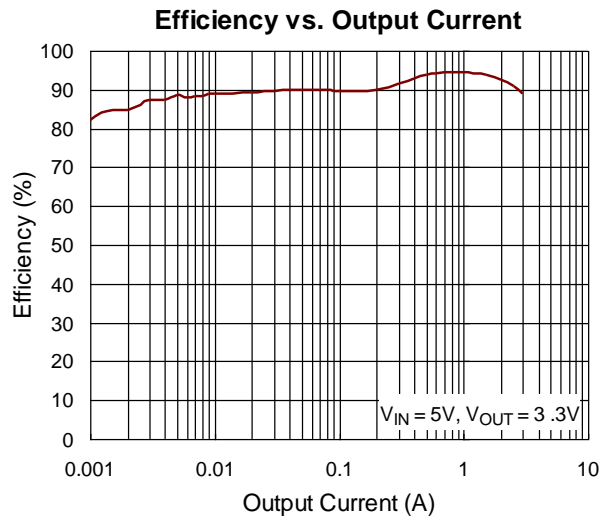
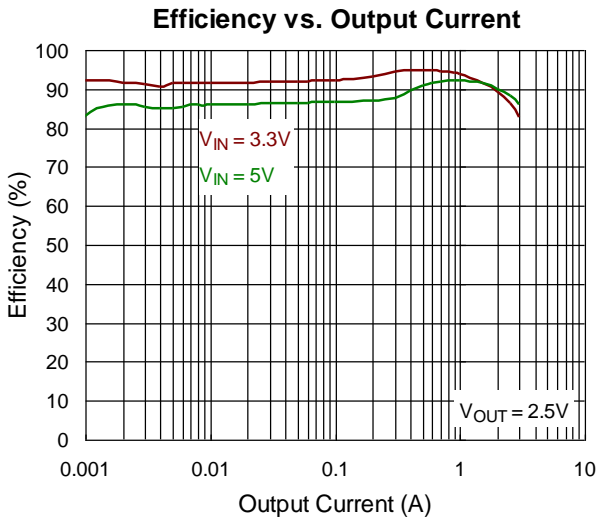
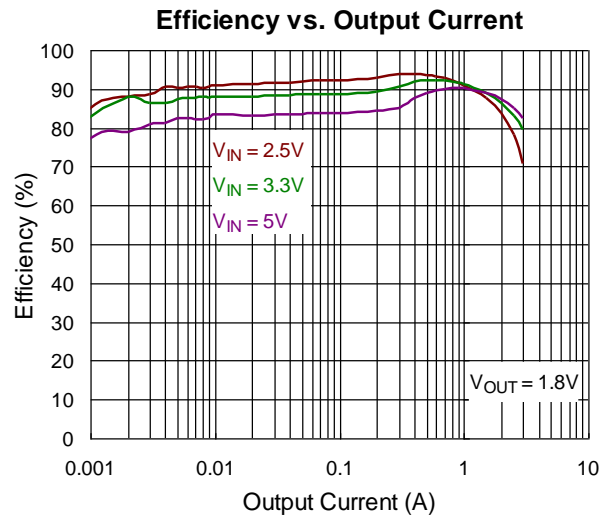
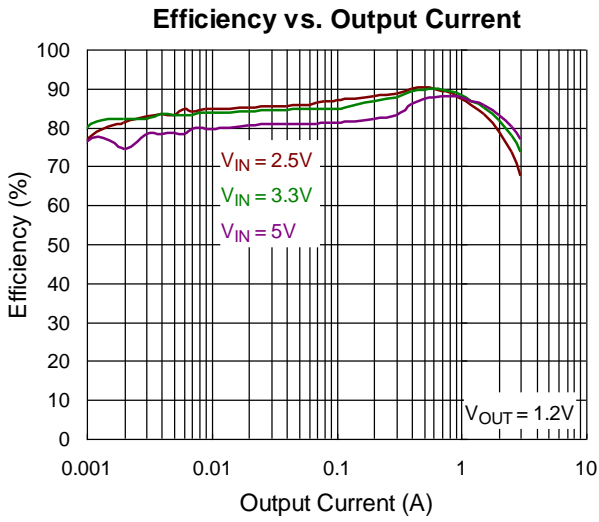

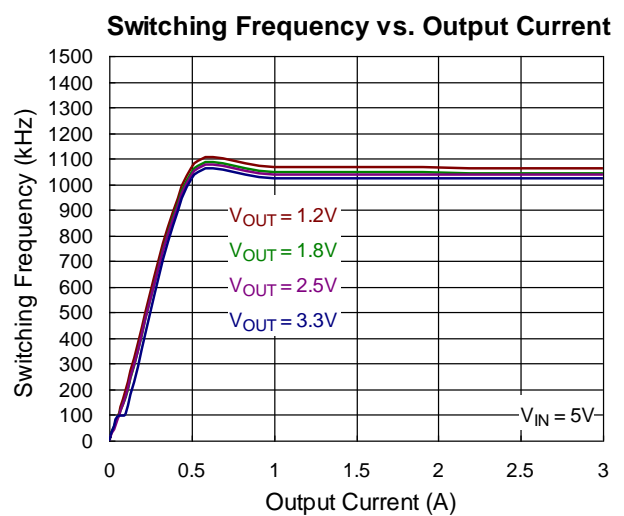
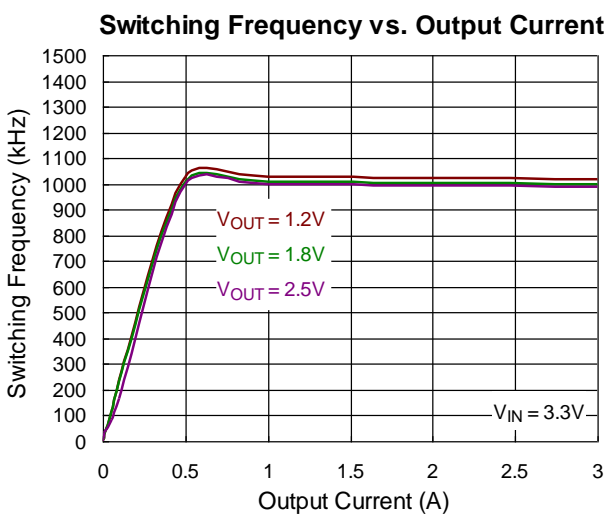
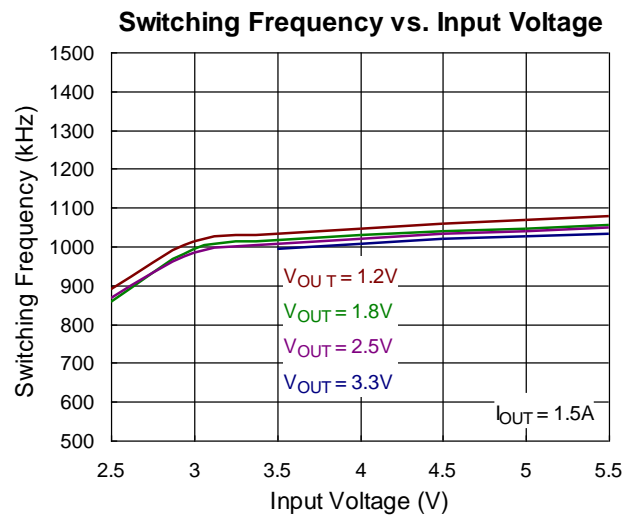
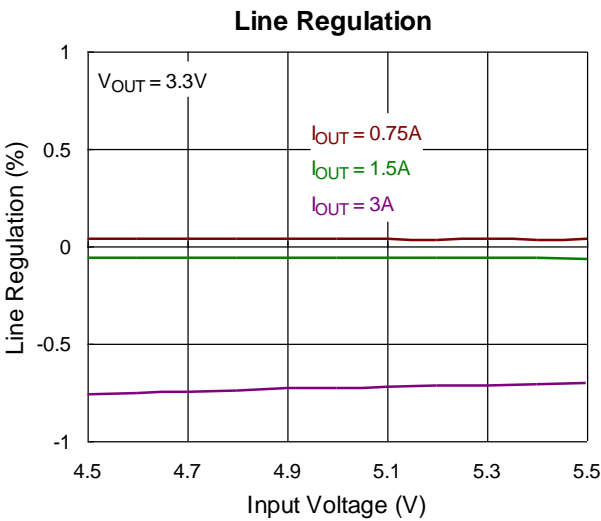
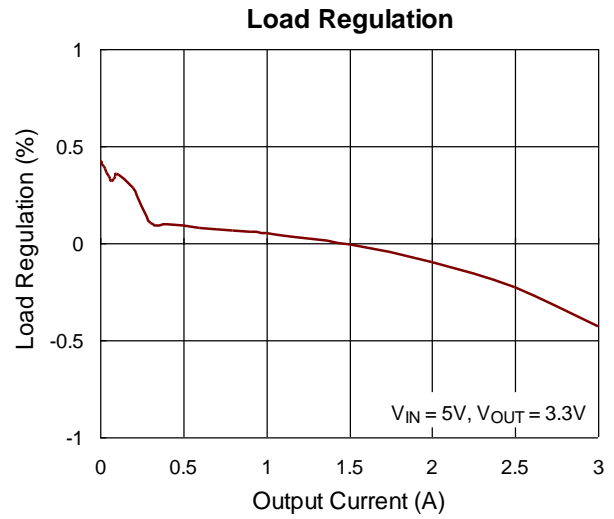
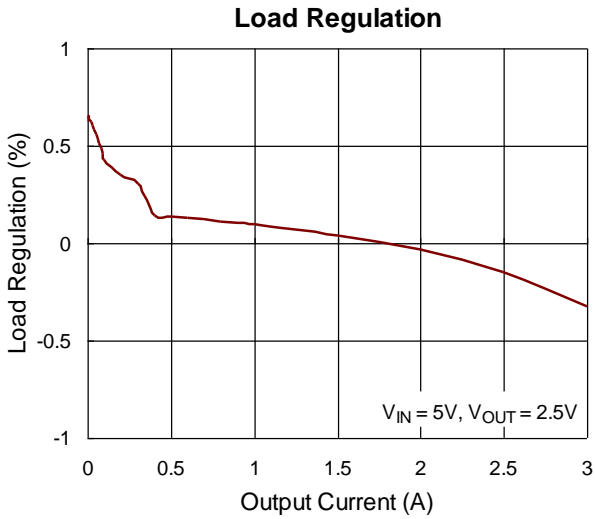

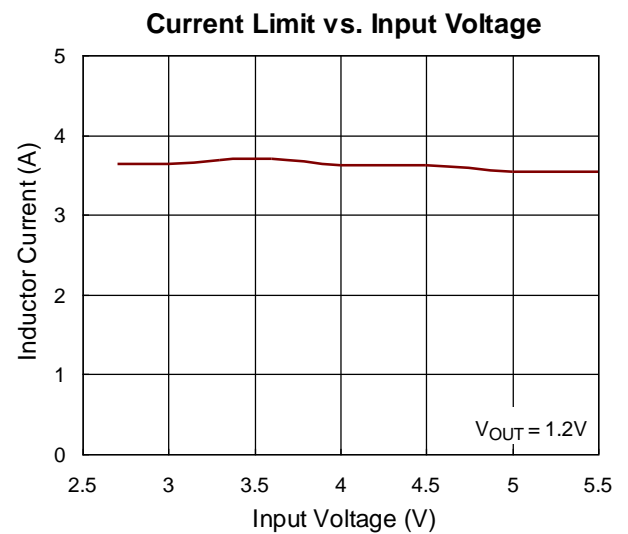
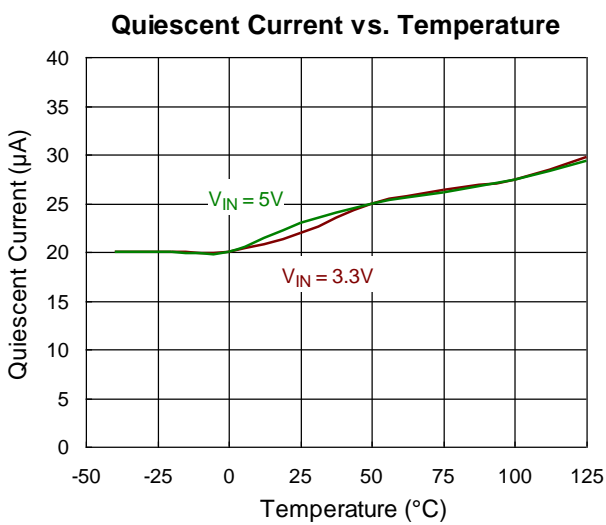
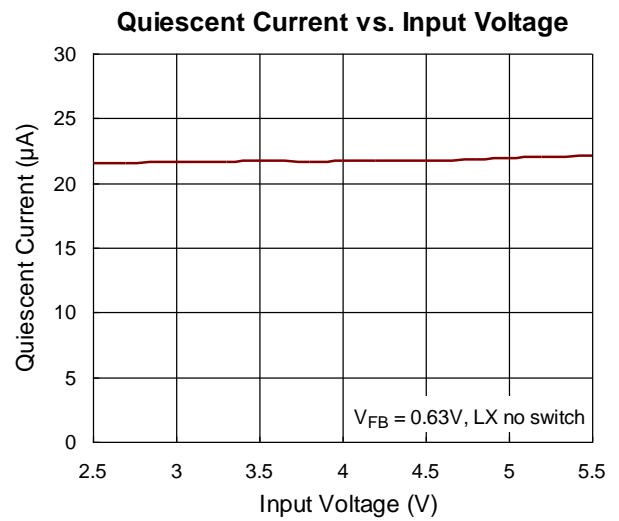
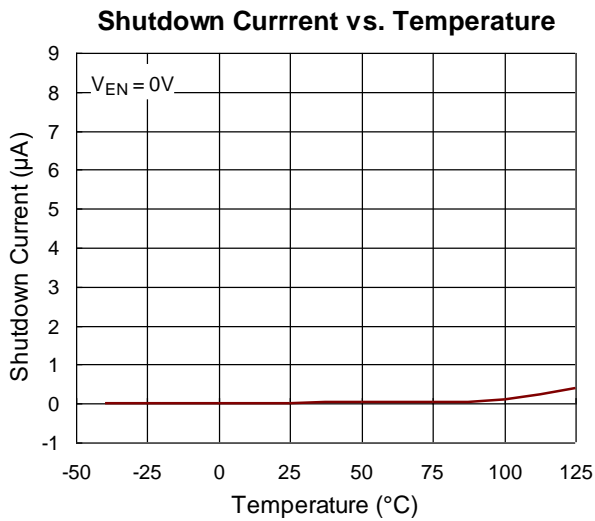
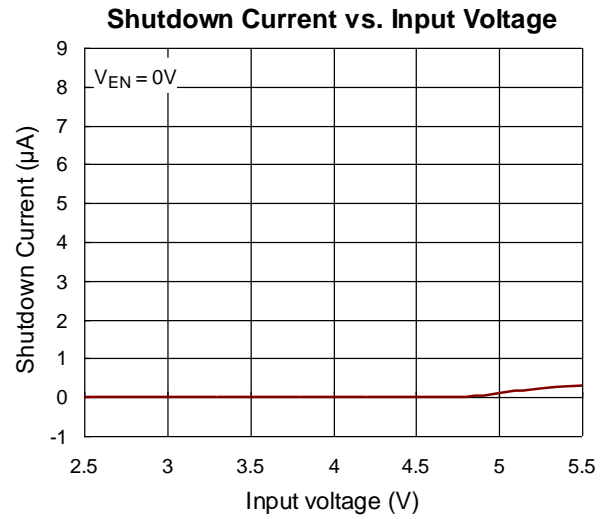
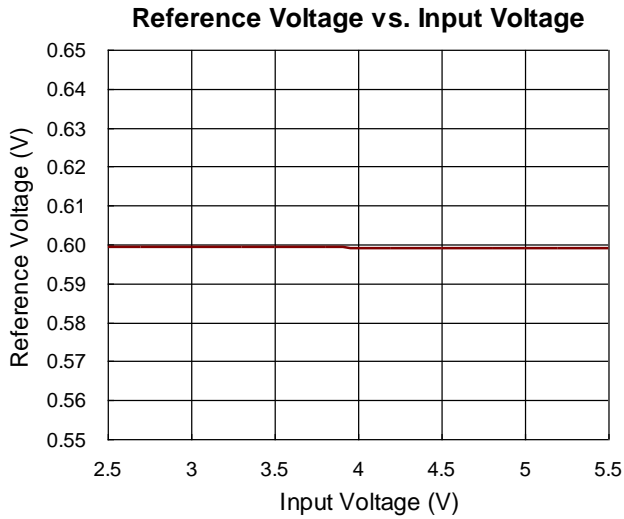

Current Limit vs. Temperature

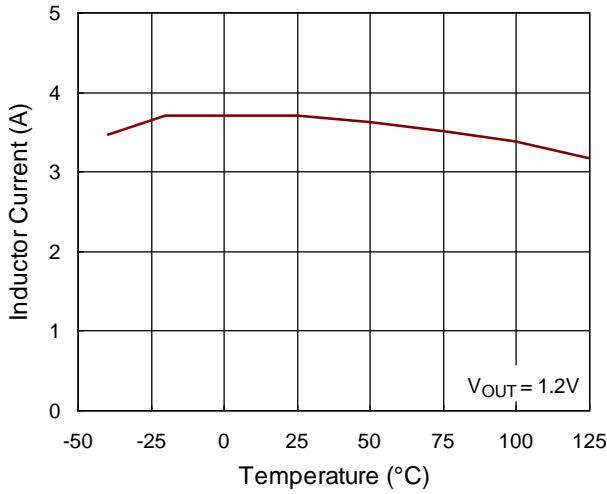

UVLO vs. Temperature

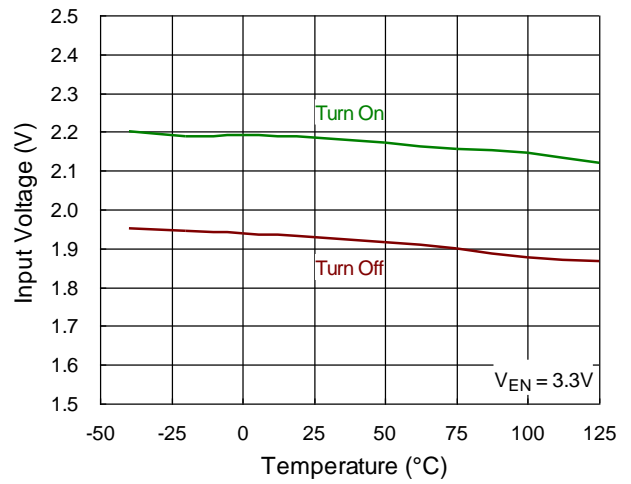

Enable Voltage vs. Temperature

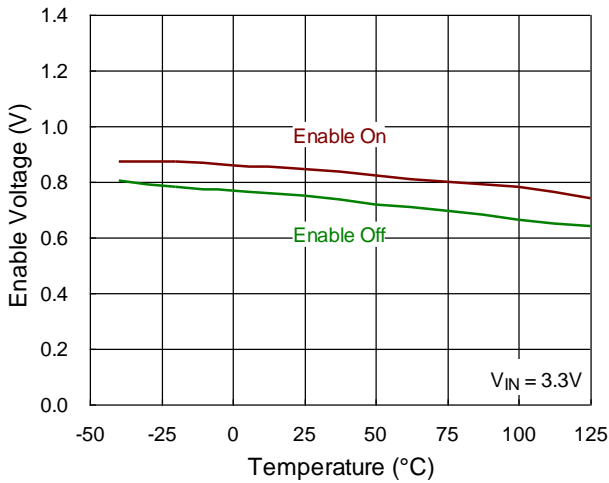

Load Transient Response

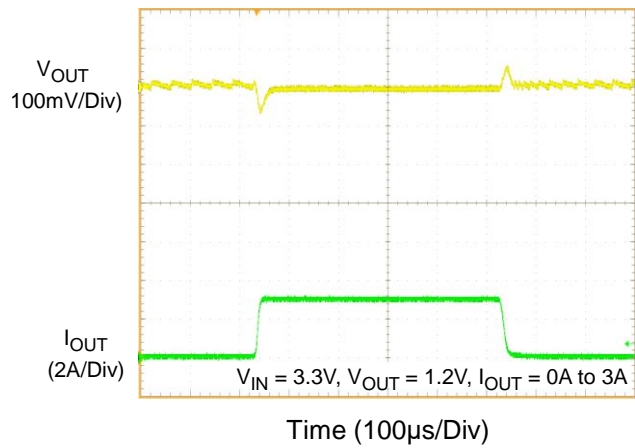

Load Transient Response

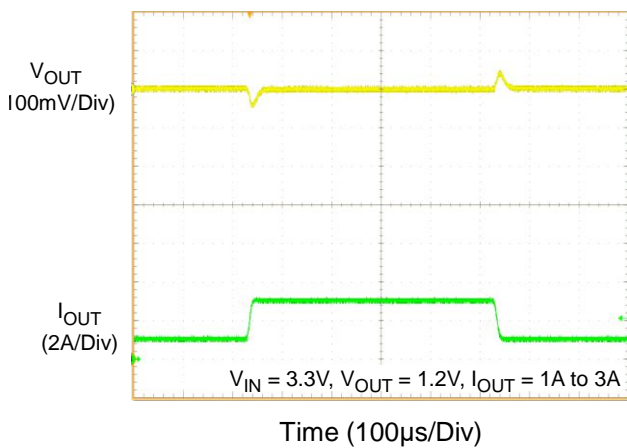

Voltage Ripple

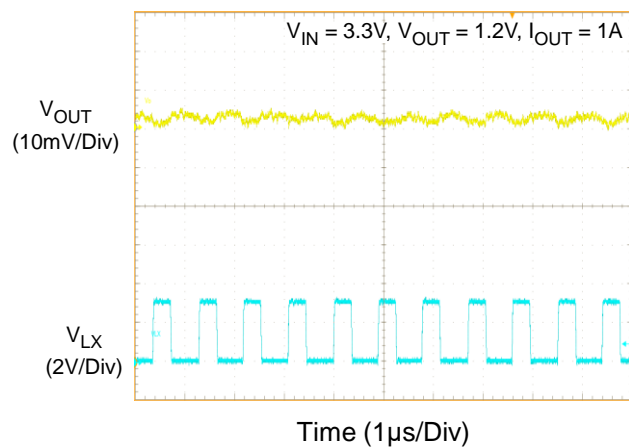

Voltage Ripple

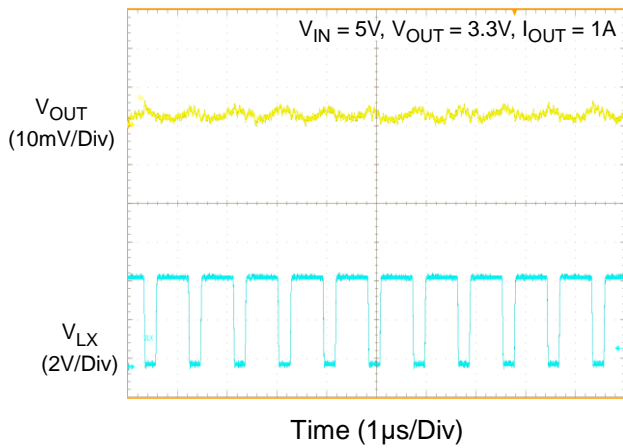

Power On from EN

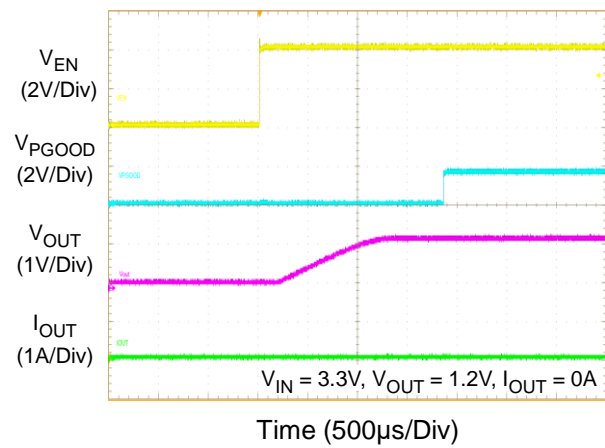

Power Off from EN

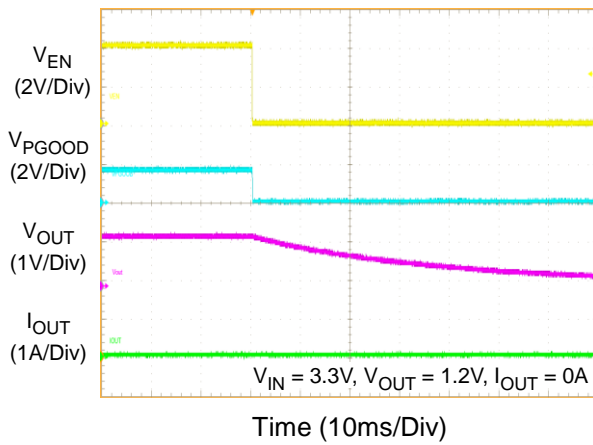

Power On from VIN

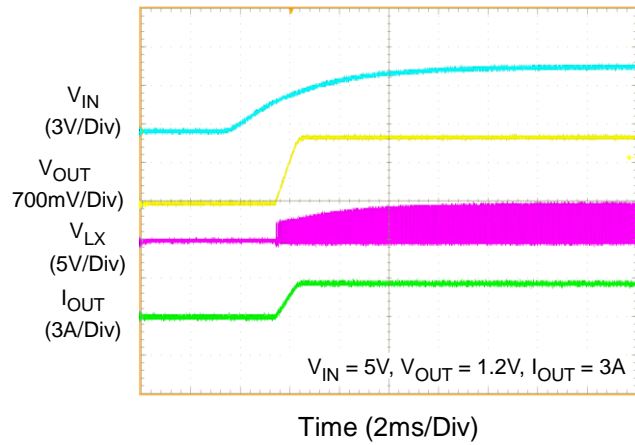

Power Off from VIN

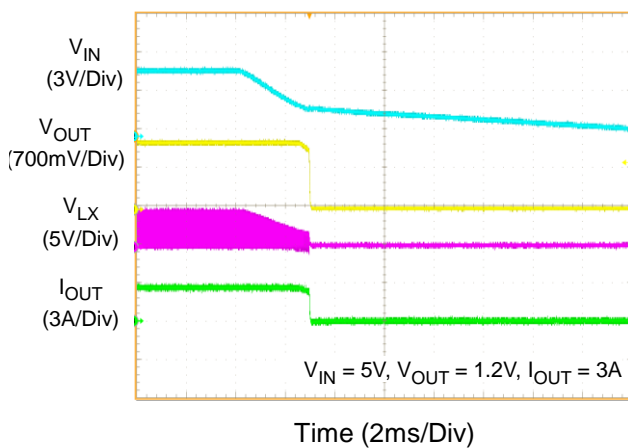

Output Voltage vs. Temperature

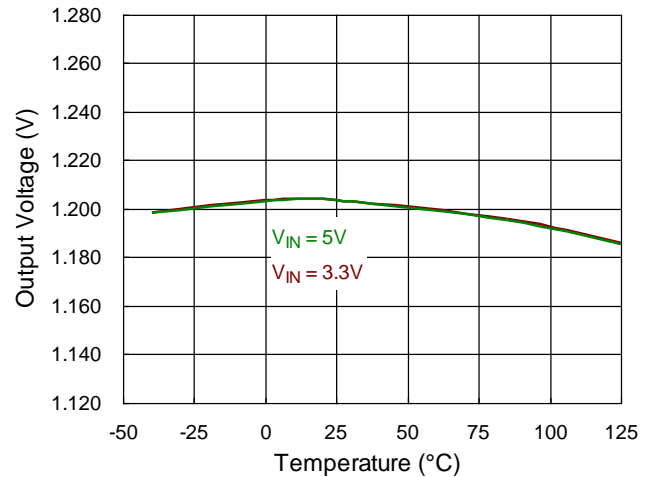

Application Information

Richtek's component specification does not include the following information in the Application Information section. Thereby no warranty is given regarding its validity and accuracy. Customers should take responsibility to verify their own designs and reserve suitable design margin to ensure the functional suitability of their components and systems.

The RT5797A is a single-phase step-down converter. It provides single feedback loop constant on-time, current mode control with fast transient response. An internal 0.6V reference allows the output voltage to be precisely regulated for low output voltage applications. A fixed switching frequency (1MHz) oscillator and internal compensation are integrated to minimize external component count. Protection features include over current protection, under voltage protection and over temperature protection.

Output Voltage Setting

Connect a resistive voltage divider at the FB between V_{OUT} and GND to adjust the output voltage. The output voltage is set according to the following equation :

$$V_{OUT} = V_{REF} \times \left(1 + \frac{R1}{R2}\right)$$

where V_{REF} is the feedback reference voltage 0.6V (typ.).

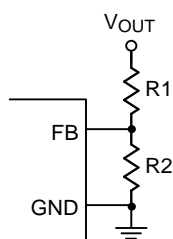

Figure 1. Setting V_{OUT} with a Voltage Divider

Chip Enable and Disable

The EN pin allows for power sequencing between the controller bias voltage and another voltage rail. The RT5797A remains in shutdown if the EN pin is lower than 400mV. When the EN pin rises above the V_{EN} trip point, the RT5797A begins a new initialization and soft-start cycle.

Enable disable falling time slew rate should be large than 1mV/ μ s.

Internal Soft-Start

The RT5797A provides an internal soft-start function to prevent large inrush current and output voltage overshoot when the converter starts up. The soft-start (SS) automatically begins once the chip is enabled. During soft-start, the internal soft-start capacitor becomes charged and generates a linear ramping up voltage across the capacitor. This voltage clamps the voltage at the FB pin, causing PWM pulse width to increase slowly and in turn reduce the input surge current. The internal 0.6V reference takes over the loop control once the internal ramping-up voltage becomes higher than 0.6V.

Over-Voltage Protection (OVP)

The RT5797AL provide Over-Voltage Protection function when output voltage over 120%. The IC will be into Latch-off mode.

UVLO Protection

The RT5797A has input Under-Voltage Lockout protection (UVLO). If the input voltage exceeds the UVLO rising threshold voltage (2.25V typ.), the converter resets and prepares the PWM for operation. If the input voltage falls below the UVLO falling threshold voltage during normal operation, the device will stop switching. The UVLO rising and falling threshold voltage has a hysteresis to prevent noise-caused reset.

Input Capacitor Selection

High quality ceramic input decoupling capacitor, such as X5R or X7R, with values greater than 22 μ F are recommended for the input capacitor. The X5R and X7R ceramic capacitors are usually selected for power regulator capacitors because the dielectric material has less capacitance variation and more temperature stability.

Voltage rating and current rating are the key parameters when selecting an input capacitor. Generally, selecting an input capacitor with voltage rating 1.5 times greater than the maximum input voltage is a conservatively safe design.

The input capacitor is used to supply the input RMS current, which can be approximately calculated using the following equation :

$$I_{IN_RMS} = I_{LOAD} \times \sqrt{\frac{V_{OUT}}{V_{IN}} \times \left(1 - \frac{V_{OUT}}{V_{IN}}\right)}$$

The next step is

selecting a proper capacitor for RMS current rating. One good design uses more than one capacitor with low equivalent series resistance (ESR) in parallel to form a capacitor bank.

The input capacitance value determines the input ripple voltage of the regulator. The input voltage ripple can be approximately calculated using the following equation :

$$\Delta V_{IN} = \frac{I_{OUT(MAX)}}{C_{IN} \times f_{SW}} \times \frac{V_{OUT}}{V_{IN}} \times \left(1 - \frac{V_{OUT}}{V_{IN}}\right)$$

Output Capacitor Selection

The output capacitor and the inductor form a low pass filter in the Buck topology. In steady state condition, the ripple current flowing into/out of the capacitor results in ripple voltage. The output voltage ripple (VP-P) can be calculated by the following equation :

$$V_{P_P} = LIR \times I_{LOAD(MAX)} \times \left(ESR + \frac{1}{8 \times C_{OUT} \times f_{SW}}\right)$$

When load transient occurs, the output capacitor supplies the load current before the controller can respond. Therefore, the ESR will dominate the output voltage sag during load transient. The output voltage undershoot (VSAG) can be calculated by the following equation :

$$V_{SAG} = \Delta I_{LOAD} \times ESR$$

For a given output voltage sag specification, the ESR value can be determined.

Another parameter that has influence on the output voltage sag is the equivalent series inductance (ESL). The rapid change in load current results in di/dt during transient. Therefore, the ESL contributes to part of the voltage sag. Using a capacitor with low ESL can obtain

better transient performance. Generally, using several capacitors connected in parallel can have better transient performance than using a single capacitor for the same total ESR.

Inductor Selection

The switching frequency (on-time) and operating point (% ripple or LIR) determine the inductor value as shown below :

$$L = \frac{V_{OUT} \times (V_{IN} - V_{OUT})}{f_{SW} \times LIR \times I_{LOAD(MAX)} \times V_{IN}}$$

where LIR is the ratio of the peak-to-peak ripple current to the average inductor current.

Find a low loss inductor having the lowest possible DC resistance that fits in the allotted dimensions. The core must be large enough not to saturate at the peak inductor current (IPEAK) :

$$I_{PEAK} = I_{LOAD(MAX)} + \left(\frac{LIR}{2} \times I_{LOAD(MAX)}\right)$$

The calculation above serves as a general reference. To further improve transient response, the output inductor can be further reduced. This relation should be considered along with the selection of the output capacitor.

Inductor saturation current should be chosen over IC's current limit.

Thermal Considerations

The junction temperature should never exceed the absolute maximum junction temperature $T_{J(MAX)}$, listed under Absolute Maximum Ratings, to avoid permanent damage to the device. The maximum allowable power dissipation depends on the thermal resistance of the IC package, the PCB layout, the rate of surrounding airflow, and the difference between the junction and ambient temperatures. The maximum power dissipation can be calculated using the following formula :

$$P_{D(MAX)} = (T_{J(MAX)} - T_A) / \theta_{JA}$$

where $T_{J(MAX)}$ is the maximum junction temperature, T_A is the ambient temperature, and θ_{JA} is the junction-to-ambient thermal resistance.

For continuous operation, the maximum operating junction temperature indicated under Recommended Operating Conditions is 125°C. The junction-to-ambient

thermal resistance, θ_{JA} , is highly package dependent. For a WDFN-8L 2x2 package, the thermal resistance, θ_{JA} , is 45.5°C /W on a standard JEDEC 51-7 high effective-thermal-conductivity four-layer test board. For a WDFN-8SL 2x2 package, the thermal resistance, θ_{JA} , is 45.6°C /W on a standard JEDEC 51-7 high effective-thermal-conductivity four-layer test board. The maximum power dissipation at $T_A = 25^\circ\text{C}$ can be calculated as below :

$$P_{D(\text{MAX})} = (125^\circ\text{C} - 25^\circ\text{C}) / (45.5^\circ\text{C} / \text{W}) = 2.19\text{W for a WDFN-8L 2x2 package.}$$

$$P_{D(\text{MAX})} = (125^\circ\text{C} - 25^\circ\text{C}) / (45.6^\circ\text{C} / \text{W}) = 2.19\text{W for a WDFN-8SL 2x2 package.}$$

The maximum power dissipation depends on the operating ambient temperature for the fixed $T_{J(\text{MAX})}$ and the thermal resistance, θ_{JA} . The derating curve in allows the designer to see the effect of rising ambient temperature on the maximum power dissipation.

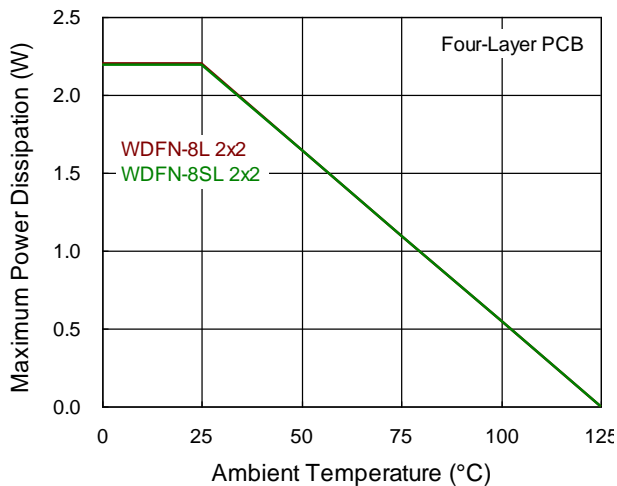

Figure 2. Derating Curve of Maximum Power Dissipation

Layout Considerations

For best performance of the RT5797A, the following layout guidelines must be strictly followed.

- ▶ Input capacitor must be placed as close to the IC as possible.
- ▶ LX should be connected to inductor by wide and short trace. Keep sensitive components away from this trace.
- ▶ Keep every trace connected to pin as wide as possible for improving thermal dissipation.
- ▶ The feedback components must be connected as close to the device as possible. Keep sensitive component away.
- ▶ Via can help to reduce power trace and improve thermal dissipation.

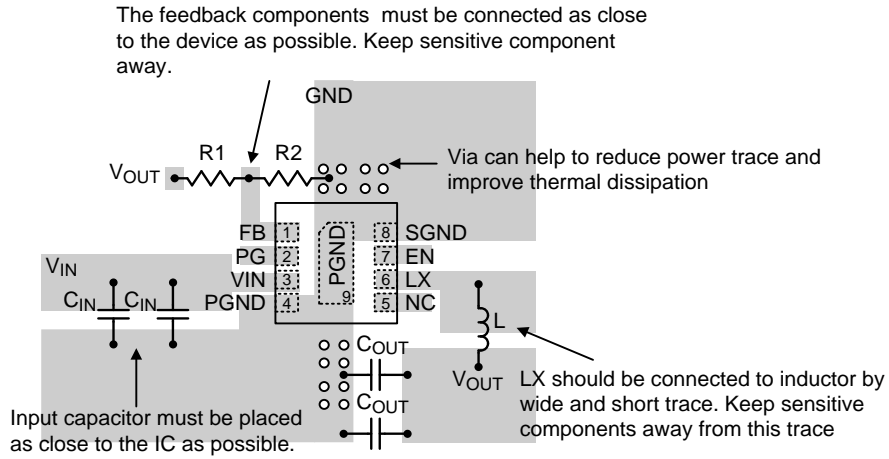
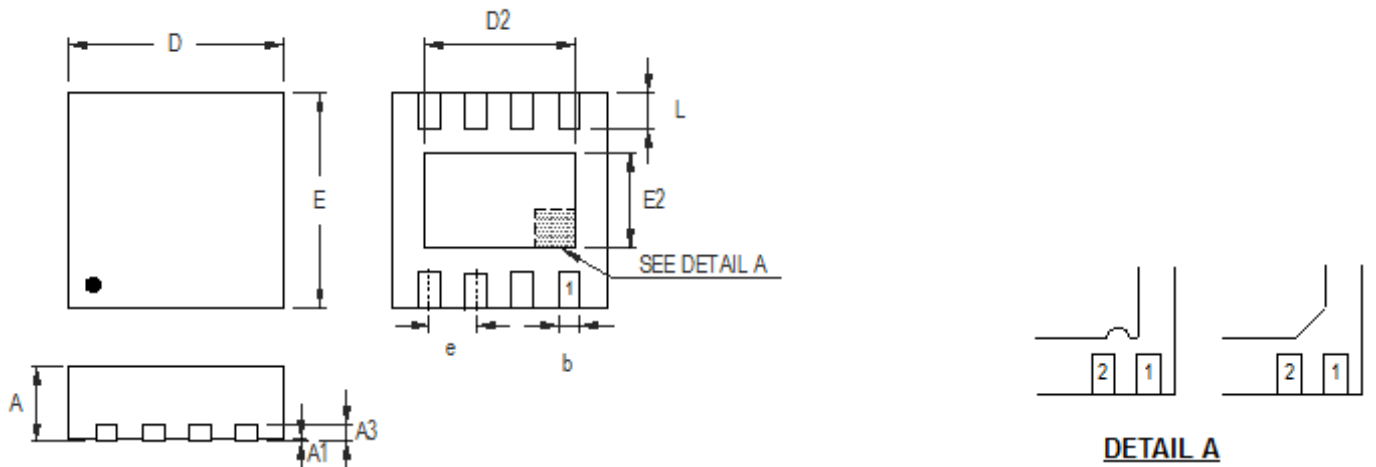

Figure 3. PCB Layout Guide

Outline Dimension



DETAIL A
Pin #1 ID and Tie Bar Mark Options

Note : The configuration of the Pin #1 identifier is optional, but must be located within the zone indicated.

Symbol	Dimensions In Millimeters		Dimensions In Inches	
	Min	Max	Min	Max
A	0.700	0.800	0.028	0.031
A1	0.000	0.050	0.000	0.002
A3	0.175	0.250	0.007	0.010
b	0.200	0.300	0.008	0.012
D	1.950	2.050	0.077	0.081
D2	1.000	1.250	0.039	0.049
E	1.950	2.050	0.077	0.081
E2	0.400	0.650	0.016	0.026
e	0.500		0.020	
L	0.300	0.400	0.012	0.016

W-Type 8L DFN 2x2 Package

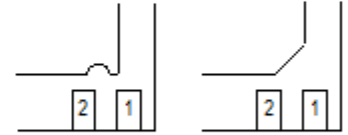
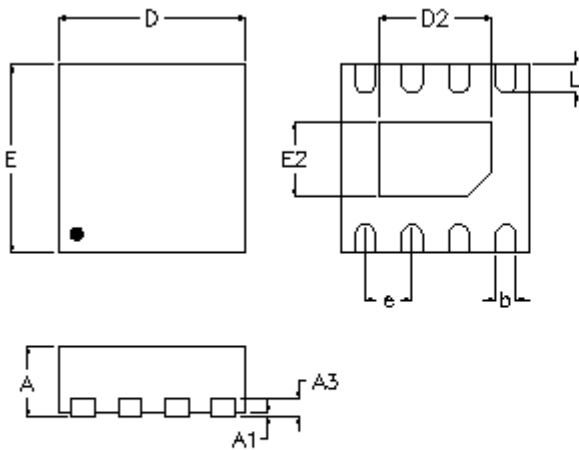

DETAIL A

Pin #1 ID and Tie Bar Mark Options

Note : The configuration of the Pin #1 identifier is optional, but must be located within the zone indicated.

Symbol	Dimensions In Millimeters		Dimensions In Inches		
	Min.	Max.	Min.	Max.	
A	0.700	0.800	0.028	0.031	
A1	0.000	0.050	0.000	0.002	
A3	0.175	0.250	0.007	0.010	
b	0.200	0.300	0.008	0.012	
D	1.900	2.100	0.075	0.083	
D2	Option1	1.150	1.250	0.045	0.049
	Option2	1.550	1.650	0.061	0.065
E	1.900	2.100	0.075	0.083	
E2	Option1	0.750	0.850	0.030	0.033
	Option2	0.850	0.950	0.033	0.037
e	0.500		0.020		
L	0.250	0.350	0.010	0.014	

W-Type 8SL DFN 2x2 Package

Note : The package of RT5797A uses Option2.

Footprint Information

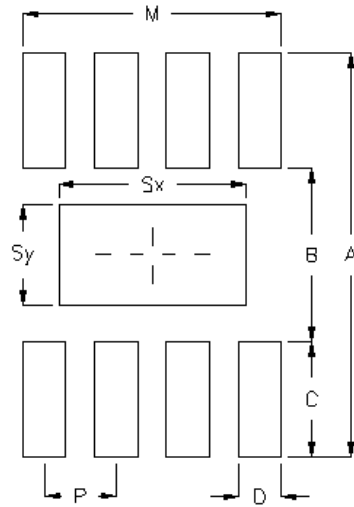

Package	Number of Pin	Footprint Dimension (mm)								Tolerance
		P	A	B	C	D	Sx	Sy	M	
V/W/U/XDFN2*2-8	8	0.50	2.80	1.20	0.80	0.30	1.30	0.70	1.80	±0.05

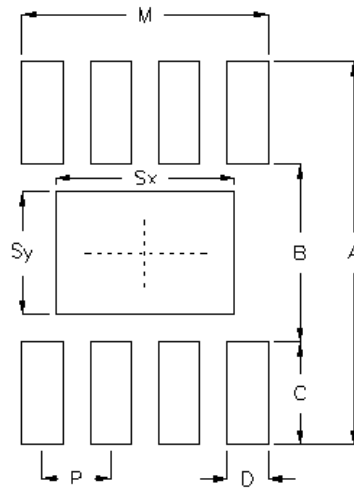

Package		Number of Pin	Footprint Dimension (mm)							Tolerance	
			P	A	B	C	D	Sx	Sy		M
V/W/U/XDFN2*2-8S	Option1	8	0.50	2.80	1.30	0.75	0.30	1.30	0.90	1.80	±0.05
	Option2							1.60	0.90		

Note : The package of RT5797A uses Option2.

Packing Information

Tape and Reel Data

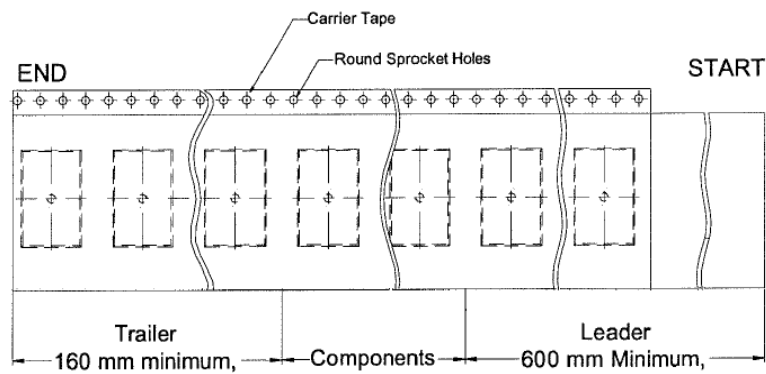
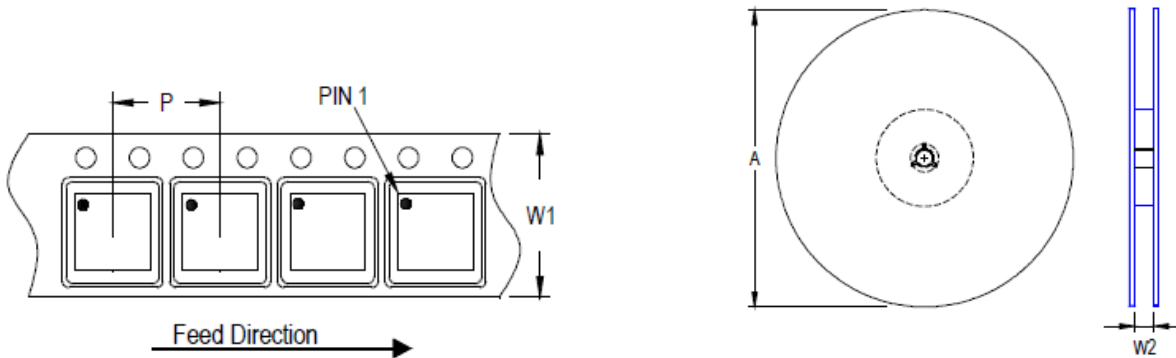



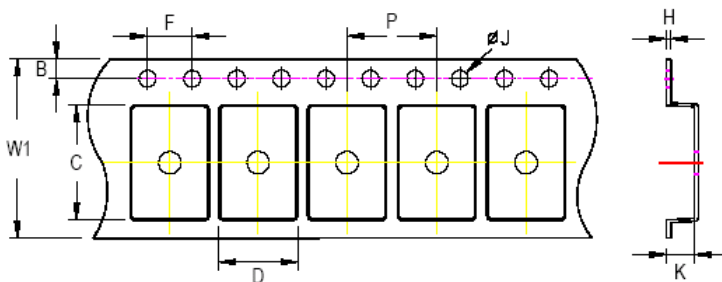



Package Type	Tape Size (W1) (mm)	Pocket Pitch (P) (mm)	Reel Size (A)		Units per Reel	Trailer (mm)	Leader (mm)	Reel Width (W2) Min./Max. (mm)
			(mm)	(in)				
QFN/DFN 2x2	8	4	180	7	2,500	160	600	8.4/9.9



C, D and K are determined by component size.
The clearance between the components and the cavity is as follows:
- For 12mm carrier tape: 0.5mm max.

Tape Size	W1		P		B		F		ØJ		H
	Max.	Min.	Max.	Min.	Max.	Min.	Max.	Min.	Max.	Max.	
8mm	8.3mm	3.9mm	4.1mm	1.65mm	1.85mm	3.9mm	4.1mm	1.5mm	1.6mm	0.6mm	

Tape and Reel Packing

Step	Photo/Description	Step	Photo/Description
1	 <p>Reel 7"</p>	4	 <p>3 reels per inner box Box A</p>
2	 <p>HIC & Desiccant (1 Unit) inside</p>	5	 <p>12 inner boxes per outer box</p>
3	 <p>Caution label is on backside of Al bag</p>	6	 <p>Outer box Carton A</p>

Package	Reel		Box				Carton			
	Size	Units	Item	Size(cm)	Reels	Units	Item	Size(cm)	Boxes	Unit
QFN & DFN 2x2	7"	2,500	Box A	18.3*18.3*8.0	3	7,500	Carton A	38.3*27.2*38.3	12	90,000
			Box E	18.6*18.6*3.5	1	2,500	For Combined or Partial Reel.			

Packing Material Anti-ESD Property

Surface Resistance	Aluminum Bag	Reel	Cover tape	Carrier tape	Tube	Protection Band
Ω/cm^2	10^4 to 10^{11}	10^4 to 10^{11}	10^4 to 10^{11}	10^4 to 10^{11}	10^4 to 10^{11}	10^4 to 10^{11}

Richtek Technology Corporation

14F, No. 8, Tai Yuen 1st Street, Chupei City

Hsinchu, Taiwan, R.O.C.

Tel: (8863)5526789

RICHTEK

Richtek products are sold by description only. Richtek reserves the right to change the circuitry and/or specifications without notice at any time. Customers should obtain the latest relevant information and data sheets before placing orders and should verify that such information is current and complete. Richtek cannot assume responsibility for use of any circuitry other than circuitry entirely embodied in a Richtek product. Information furnished by Richtek is believed to be accurate and reliable. However, no responsibility is assumed by Richtek or its subsidiaries for its use; nor for any infringements of patents or other rights of third parties which may result from its use. No license is granted by implication or otherwise under any patent or patent rights of Richtek or its subsidiaries.

Copyright © 2023 Richtek Technology Corporation. All rights reserved. **RICHTEK** is a registered trademark of Richtek Technology Corporation.

Datasheet Revision History

Version	Date	Description	Item
12	2023/12/28	Modify	General Description on P1 Ordering Information on P1 Operation on P3 Application Information on P13 Outline Dimension on P17 Footprint Information on P18, 19 Packing Information on P20, 21, 22

Mouser Electronics

Authorized Distributor

Click to View Pricing, Inventory, Delivery & Lifecycle Information:

[Richtek:](#)

[RT5797AHGQWA](#) [RT5797ALGQW](#)