

Single Phase Glass Passivated Silicon Bridge Rectifier

$V_{RRM} = 50\text{ V} - 400\text{ V}$

$I_O = 4\text{ A}$

Features

- Plastic package has Underwriters Laboratory Flammability Classification 94V-0
- This series is UL listed under the Recognized
- Glass passivated chip junction
- High case dielectric strength
- Typical I_R less than 0,1 A
- High surge current capability
- Ideal for printed circuit boards
- Not ESD Sensitive

Mechanical Data

Case: Molded plastic body over passivated junctions
 Terminals: Plated leads, solderable per MIL-STD-750 Method 2026.
 Weight: 0.071 oz, 2.0 g

GBL Package

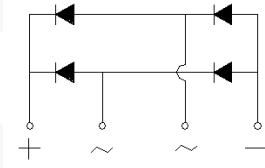

Maximum ratings at $T_c = 25\text{ }^\circ\text{C}$, unless otherwise specified

Parameter	Symbol	Conditions	GBL005	GBL01	GBL02	GBL04	Unit
Repetitive peak reverse voltage	V_{RRM}		50	100	200	400	V
RMS reverse voltage	V_{RMS}		35	70	140	280	V
DC blocking voltage	V_{DC}		50	100	200	400	V
Operating temperature	T_j		-55 to 150	-55 to 150	-55 to 150	-55 to 150	$^\circ\text{C}$
Storage temperature	T_{stg}		-55 to 150	-55 to 150	-55 to 150	-55 to 150	$^\circ\text{C}$

Electrical characteristics at $T_c = 25\text{ }^\circ\text{C}$, unless otherwise specified

Single phase, half sine wave, 60 Hz, resistive or inductive load
 For capacitive load derate current by 20%

Parameter	Symbol	Conditions	GBL005	GBL01	GBL02	GBL04	Unit
Maximum average forward rectified current	I_O	$T_c = 50\text{ }^\circ\text{C}$ (Note 1)	4.0	4.0	4.0	4.0	A
		$T_c = 40\text{ }^\circ\text{C}$ (Note 2)	3.0	3.0	3.0	3.0	A
Peak forward surge current	I_{FSM}	$t_p = 8.3\text{ ms}$, half sine	135	135	135	135	A
Maximum instantaneous forward voltage drop per leg	V_F	$I_F = 4\text{ A}$	1.1	1.1	1.1	1.1	V
Maximum DC reverse current at rated DC blocking voltage per leg	I_R	$T_a = 25\text{ }^\circ\text{C}$	5	5	5	5	μA
		$T_a = 125\text{ }^\circ\text{C}$	500	500	500	500	μA
Rating for fusing	I^2t	$t < 8.3\text{ ms}$	75	75	75	75	A^2sec
Typical junction capacitance per leg (Note 3)	C_j		95	95	95	95	pF
Typical thermal resistance per leg	$R_{\theta JA}$	(Note 1)	22	22	22	22	$^\circ\text{C/W}$
	$R_{\theta JL}$	(Note 2)	3.5	3.5	3.5	3.5	$^\circ\text{C/W}$

¹ - Unit mounted on 3.0" x 3.0" x 0.11" (75 mm x 75 mm x 3 mm) Al plate

² - Unit mounted on P.C.B. At 0.375" (9.5 mm) lead length and 0.5" x 0.5" (12 mm x

³ - Measured at 1.0 MHz and applied reverse bias of 4.0 V

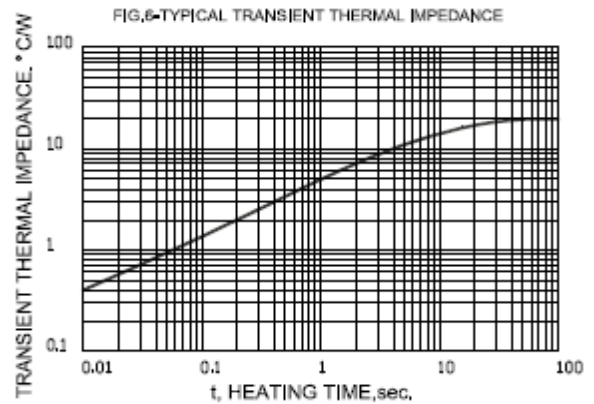
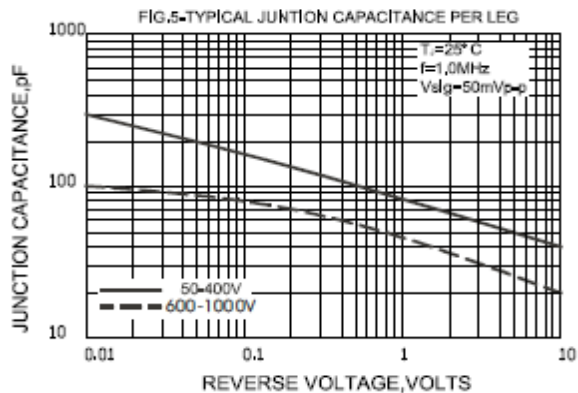
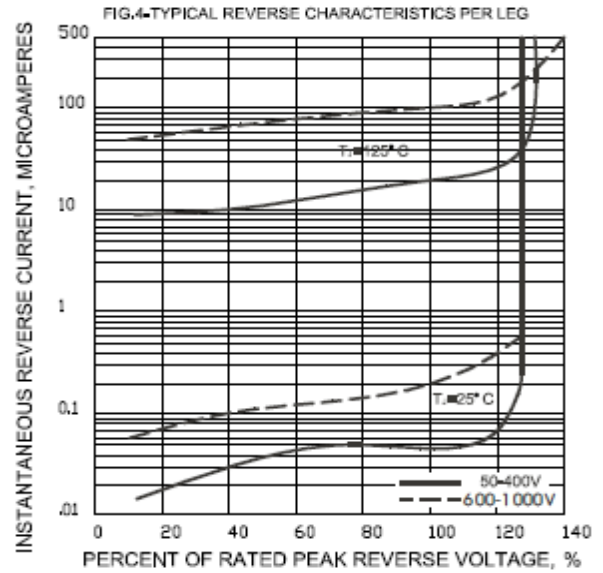
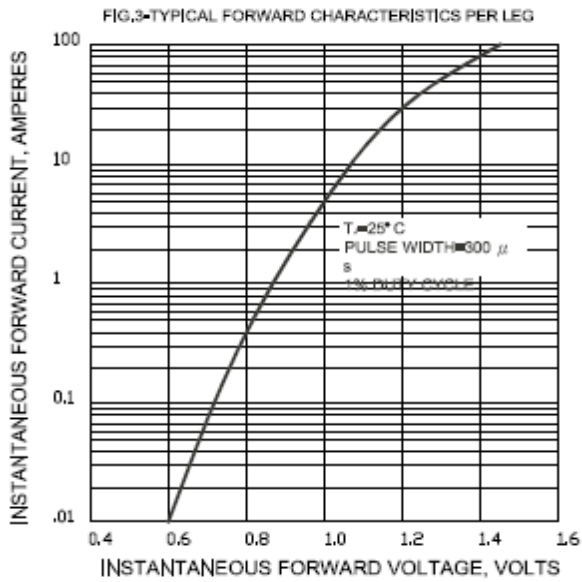
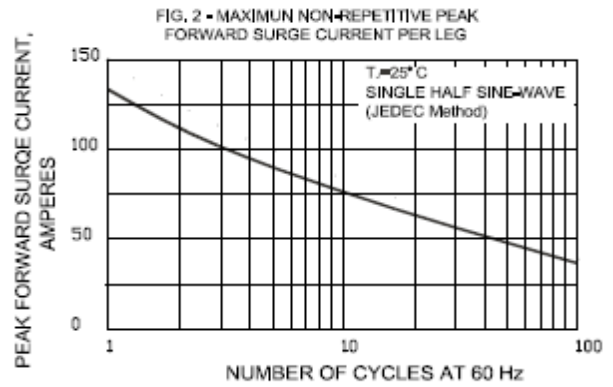
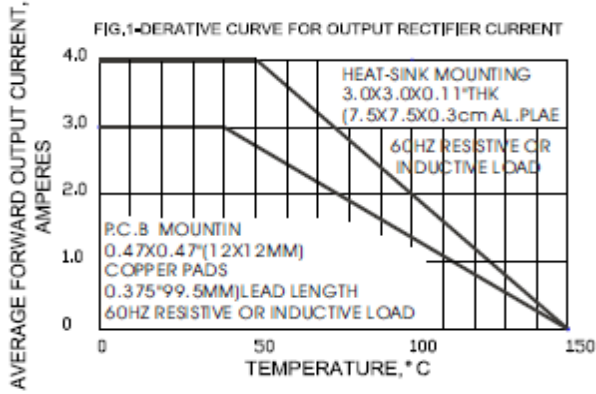

Package dimensions and terminal configuration

Product is marked with part number and terminal configuration.

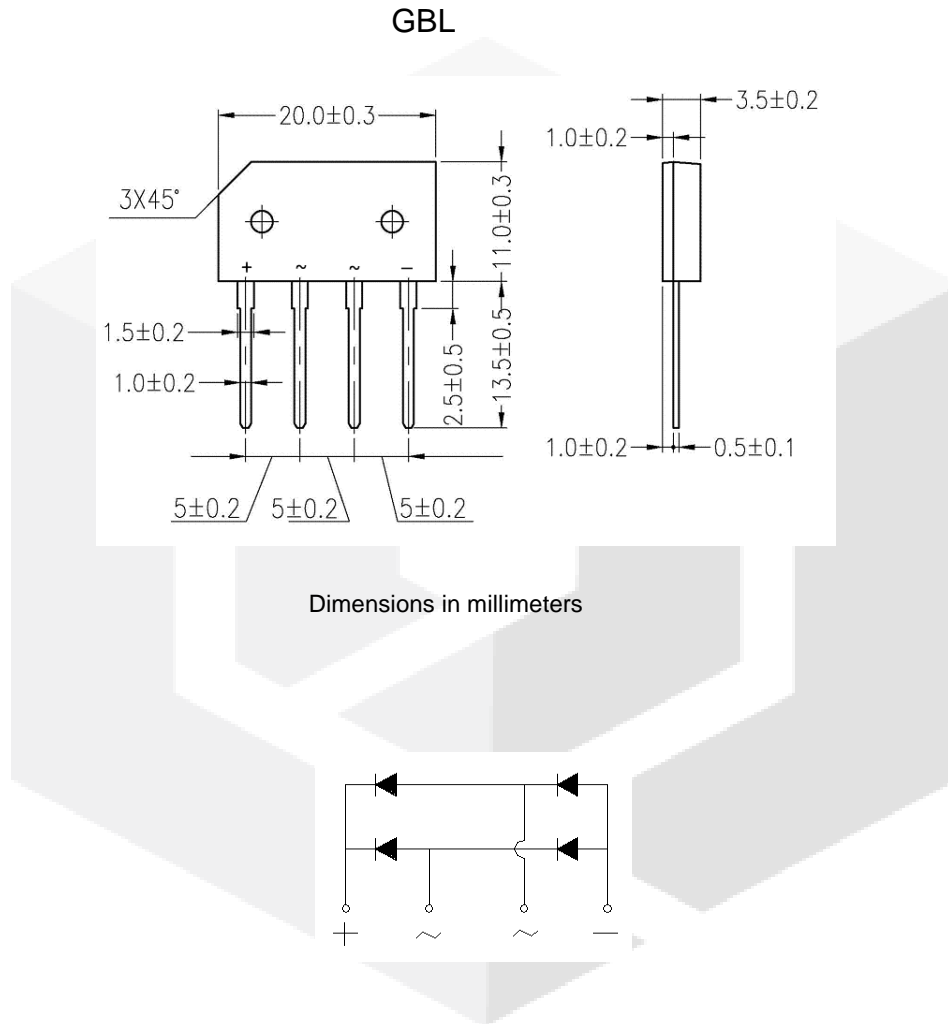

Mouser Electronics

Authorized Distributor

Click to View Pricing, Inventory, Delivery & Lifecycle Information:

[Navitas Semiconductor:](#)

[GBL02](#)