

Deckel/lid

* = Maß durch Formkonizität nach unten verringert.
 Freimaß - Toleranz nach DIN 16901-130/
Dimension reduced at bottom due to conical form.
Tolerances to DIN 16901-130.

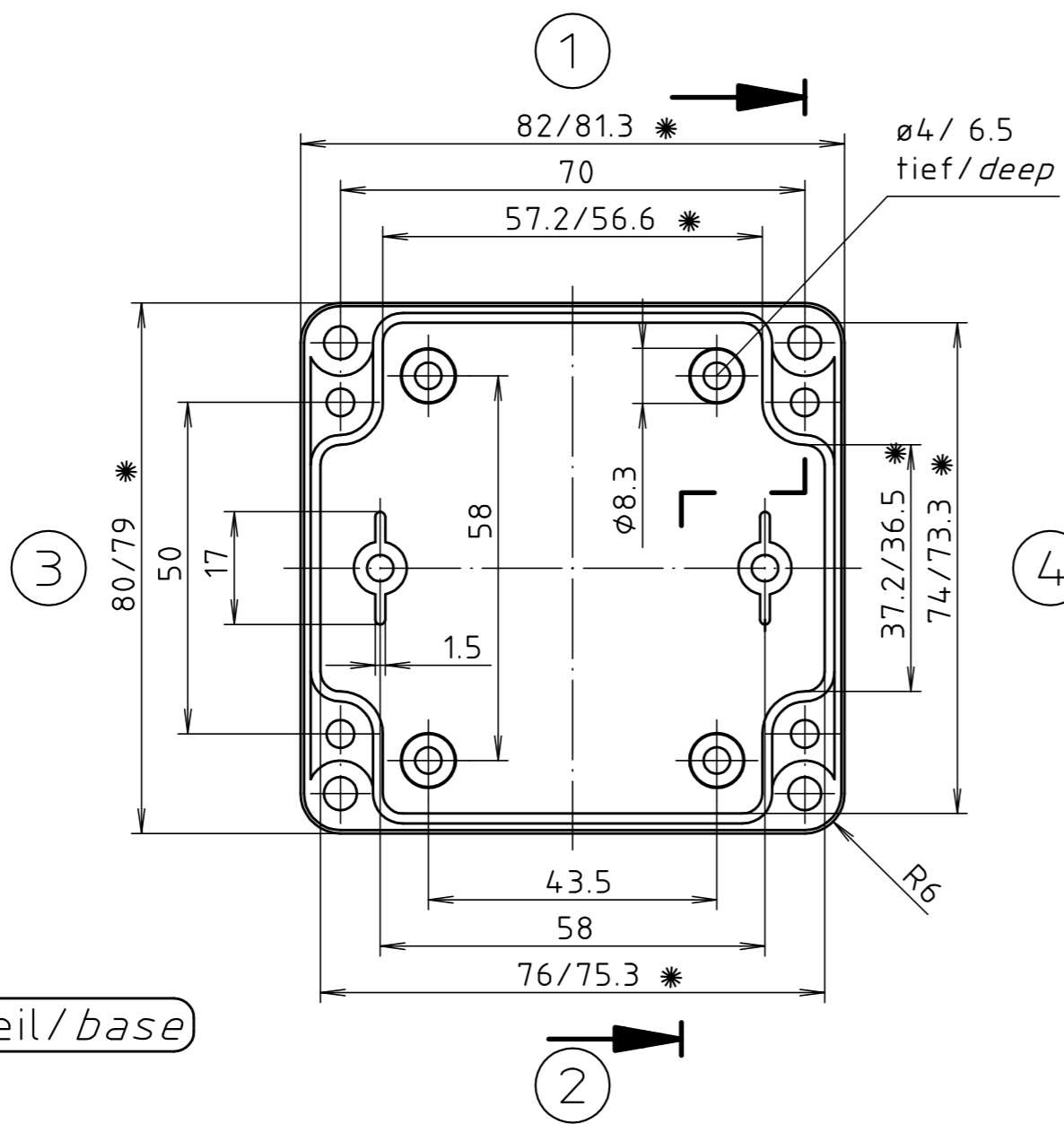

Unterteil/base

Zylinderschraube M4 x 24/10
 ähnl. DIN EN ISO 7045/
cylinder screw M4 x 24/10
similar to DIN EN ISO 7045

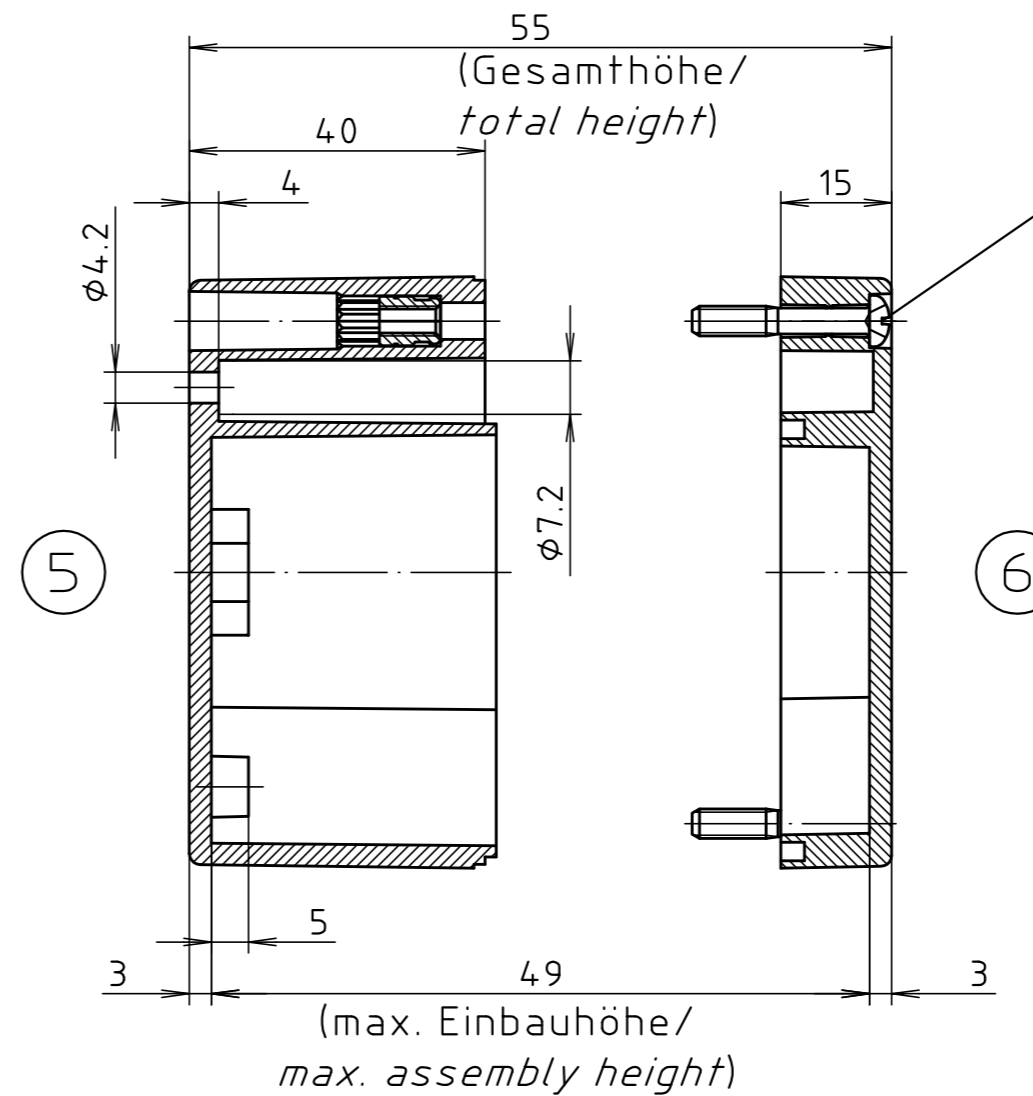

ABS-Gehäuse können durch eine andere
 Schwindung ca. 0,1-0,25% größer sein
 als gezeichnete PC-Gehäuse/
Due to a different shrinkage rate of
the plastic material, ABS enclosures can
be about 0.1 - 0.25% bigger than the
PC enclosures shown in the drawing.

Maßstab/ Scale:	1:1	
Zeichnungs-Nr. / Drawing-No.:	2K 210.054.03	
Artikel / Article:	M/T 210 mit Nocken M/T 210 with bosses	
Katalogzeichnung/Catalogue drawing		
A.Nr./ Alt-No.:	3601 3499	Datum/ Date:
	22.04.02 15.02.2000	
DISK:	2 501 101	
Datum/Date:	25.10.93 OK	



Mouser Electronics

Authorized Distributor

Click to View Pricing, Inventory, Delivery & Lifecycle Information:

[Phoenix Mecano:](#)

[02210100](#)