

WLS28 Pro LED Strip Light Instruction Manual



Original Instructions
p/n: 220693 Rev. C
October 12, 2023

© Banner Engineering Corp. All rights reserved.

Contents

Chapter 1 Features

Models	3
--------------	---

Chapter 2 Configuration Instructions

Pro Editor	5
Full Preview Connection (Required)	5
Wiring Diagrams	6
Pro Editor Configuration for the WLS28	6

Chapter 3 Specifications

FCC Part 15 Class B	10
Industry Canada ICES-003(B)	11
Dimensions	11
Photometric Data	11

Chapter 4 Accessories

Cordsets	17
Brackets	18

Chapter 5 Banner Engineering Corp Limited Warranty

Mexican Importer	21
------------------------	----

Chapter 1 Features

Banner’s WLS28 Pro LED Strip Lights have sturdy aluminum housings, shatterproof windows, and impressive environmental ratings, making them an ideal general-purpose LED light for machine, enclosure, or other industrial lighting applications.

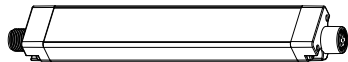

- High quality illumination and indication from RGBW LEDs
- Six white color temperatures for comfort and compatibility
- 13 color options for varied indication and inspection uses
- Programmable using Banner's Pro Editor software and Pro Converter Cable
- Pro Editor software configuration and three discrete inputs gives access to color, flashing, intensity, and animation settings, as well as advanced operating modes for displaying distance, count, time and position
- Available in six lengths from 145 mm to 1130 mm
- Lensed models or choice of clear or diffuse window

IMPORTANT: Read the following instructions before operating the light. Please download the complete WLS28 Pro LED Strip Light technical documentation, available in multiple languages, from www.bannerengineering.com for details on the proper use, applications, Warnings, and installation instructions of this device.

IMPORTANT: Lea el siguiente instructivo antes de operar el luminario. Por favor descargue desde www.bannerengineering.com toda la documentación técnica de los WLS28 Pro LED Strip Light, disponibles en múltiples idiomas, para detalles del uso adecuado, aplicaciones, advertencias, y las instrucciones de instalación de estos dispositivos.

IMPORTANT: Lisez les instructions suivantes avant d'utiliser le luminaire. Veuillez télécharger la documentation technique complète des WLS28 Pro LED Strip Light sur notre site www.bannerengineering.com pour les détails sur leur utilisation correcte, les applications, les notes de sécurité et les instructions de montage.

Models

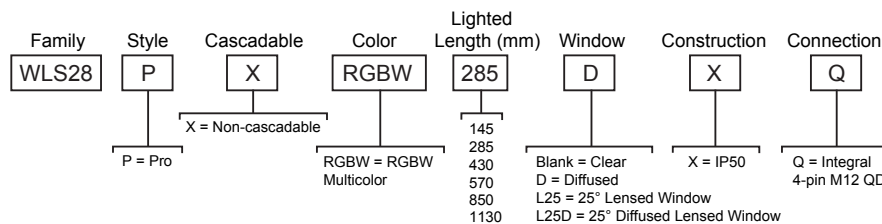

Blank page

Chapter Contents

Pro Editor 5
Wiring Diagrams 6
Pro Editor Configuration for the WLS28 6

Chapter 2 Configuration Instructions

Pro Editor

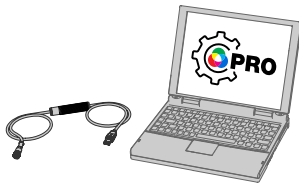

Use Banner's Pro Editor software and Pro Converter Cable to create custom configurations by selecting different colors, flash patterns, and animations. For more information visit www.bannerengineering.com/proeditor.

Full Preview Connection (Required)

The full preview connection must be used for the WLS28 Pro LED Strip Light.

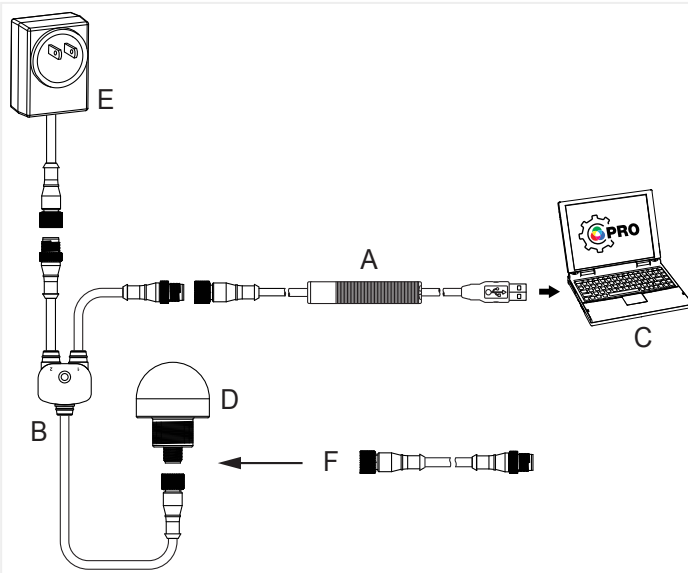

- A = Pro Converter Cable (MQDC-506-USB)
- B = Splitter (CSB-M1251FM1251M)
- C = PC running Pro Editor software
- D = Any Banner Pro Series-enabled device (K50 shown)
- E = Power Supply (PSW-24-1 or PSD-24-4)
- F = 8-Pin to 5-Pin Double-Ended Cordset (MQDC-801-5M-PRO), required for 8-Pin models

Wiring Diagrams

Male	Pin	Wire Color	Description ⁽¹⁾
	1	Brown	Input 1
	2	White	Input 3
	3	Blue	DC common
	4	Black	Input 2

7 Color Binary Control (<i>Binary input state controls color, default configuration</i>)			
Input 1: Pin 1 Brown Wire	Input 2: Pin 4 Black Wire	Input 3: Pin 2 White Wire	LED Color
—	—	—	Light OFF
18 V DC to 30 V DC	—	—	Daylight White
—	18 V DC to 30 V DC	—	Green
—	—	18 V DC to 30 V DC	Red
18 V DC to 30 V DC	18 V DC to 30 V DC	—	Yellow
18 V DC to 30 V DC	—	18 V DC to 30 V DC	Blue Bounce with Daylight White Background
—	18 V DC to 30 V DC	18 V DC to 30 V DC	Daylight White with Red Ends Flash
18 V DC to 30 V DC	18 V DC to 30 V DC	18 V DC to 30 V DC	Warm White

Pro Editor Configuration for the WLS28

Banner's Pro Editor software offers an easy way to configure Pro Series-enabled touch and indicator devices, allowing users full control of device states. The easy-to-use configuration software provides a variety of tools and capabilities to solve a wide range of applications. Configure any Pro Series-enabled device using the free Pro Editor software, available for download at www.bannerengineering.com/proeditor.

Machine and Work Cell—Choose colors and animations to create up to seven discretely controlled illumination and status states. Spans functionality from single segment to two-colored animations.

Single Segment—The single segment option shows the WLS28 in one solid color. The input wires are used to change colors. Flashing and intensity options are available. Presets are available for common configurations, which can be adjusted as desired.

End Status—The end status option shows the inside section of the WLS28 in one color and the ends of the light in another. The size of the two sections are customizable. The input wires are used to change color states. Flashing and intensity options are available.

Process Visualization—The process visualization option enables a choice of colors, animations, speeds, and intensities to provide visual information that corresponds to equipment or process status. Single color illumination states are also available.

Tower Light—Choose colors, intensities, and animations to create a discretely controlled two or three segment indicator. The segments are controlled independently with input wires.

Timer—The timer option uses the WLS28 as a timer, counting up or counting down. Set the total time and choose up to four thresholds to change the visual appearance of the light as time advances. The timer starts when 18 V DC to 30 V DC is applied to the timer run input wire, and paused when left floating or tied to ground. The timer resets when 18 V DC to 30 V DC is applied to the reset wire. The timer automatically resets when it reaches the final count. A steady global background can be applied, from which color and intensity can be defined.

Counter—The counter option counts up or down by converting input pulses into movement of LEDs along the length of the light based on up to four thresholds that define colors, intensity, and flashing. When the rising edge of an 18 V DC to 30 V DC pulse is applied to the counter input wire, the count changes by one. The counter resets when 18 V DC to 30 V DC is applied

⁽¹⁾ Input functionality can change depending on configuration created with Pro Editor.

to the reset wire. The counter automatically resets when it reaches the final count. A steady global background can be applied, from which color and intensity can also be defined.

Distance—The distance mode uses the light to display colored LEDs proportional to a PFM (pulse frequency modulation) or PWM (pulse width modulation) input and set range. The light adjusts position and color continuously based on the input value and defined color, flash, and intensity in up to four thresholds while maintaining an optional steady background for LEDs outside the active threshold range. The PFM signal frequency range can be from 100 to 10,000 Hz. The PWM duty cycle range can be from 0 to 100%.

Gauge—The gauge option controls the color and position of a band of LEDs based on a defined PFM or PWM input value and range. The width of the band is defined as a percentage of total lighted length. The light adjusts the position and color of the band and background continuously based on the input signal and defined color, flash, intensities, and animations in upper, lower, and center thresholds. The PFM signal frequency range can be from 100 to 10,000 Hz. The PWM duty cycle range can be from 0 to 100%.

Animation Settings

Animation	Description
Off	Device OFF, no animation displays
Steady	Color 1 is solid ON at the defined intensity
Flash	Color 1 flashes at the defined speed, color intensity, and pattern (normal, strobe, three pulse, SOS, or random)
Two Color Flash	Color 1 and Color 2 flash alternately at the defined speed, color intensities, and pattern (normal, strobe, three pulse, SOS, or random)
Two Color Shift	Color 1 and Color 2 flash alternately on adjacent LEDs at defined speed and color intensities
Ends Steady	Color 1 defines the center 75% of the light. Color 2 defines the 12.5% of the light on each end. Center and ends are on steady. Center proportion can be defined in End Status mode
Ends Flash	Color 1 defines the center 75% of the light. Color 2 defines the 12.5% of the light on each end. The ends will flash at defined speed and pattern. Center proportion can be defined in End Status mode
Scroll	Color 1 defines a band 20% of the length of the light that moves in one direction up or down against the background of Color 2 at the defined speed and color intensities
Center Scroll	Color 1 defines a band 10% the length of the light that moves from the center of the light to the ends against the background of Color 2 at the defined speed and color intensity
Bounce	Color 1 defines a band 20% of the length of the light that moves up and down between the top and bottom of the light against the background of Color 2 at the defined speed and color intensities
Center Bounce	Color 1 defines a band 10% the length of the light that moves from the center of the light to the ends and back against the background of Color 2 at the defined speed and color intensity
Intensity Sweep	Color 1 continuously increases and decreases intensity between 0% to 100% at defined speed and color intensity
Two Color Sweep	Color 1 and Color 2 define the end values of a line across the color gamut. The light continuously displays a color by moving along the line at the defined speed and color intensity
Color Spectrum	The light scrolls through the 13 predefined colors with a different color on each LED at the defined speed, Color 1 intensity, and direction
Single End Steady (WLS15 Pro only)	Color 1 is solid ON at the defined intensity on one end of the device
Single End Flash (WLS15 Pro only)	Color 1 flashes at the defined speed, color intensity, and pattern (normal, strobe, three pulse, SOS, or random) on one end of the device

By default, when the sub-applications for Machine and Work Cell are selected, Pro Editor opens **I/O State** configuration in **Advanced**. Three **I/O states** are available:

I/O State Configuration Settings	Description
Basic	Configurations made in this state assign one wire to one state, with the following override control: <ul style="list-style-type: none"> Pin 4 (Black) overrides Pin 1 (Brown) Pin 2 (White) overrides Pins 1 and 4 (Brown and Black)
Advanced	I/O state with full seven state options for maximum configuration. Configurations made in Advanced assign binary wiring combinations of all valid inputs to each state.

Continued on page 8

Continued from page 7

I/O State Configuration Settings	Description
I/O Block	Three state control for use with I/O block. Configurations made in I/O Block assign states to the black, white, and combination of black and white wires for use with I/O blocks for which power (brown) and common (blue) are always on for five pin connections.

Chapter Contents

FCC Part 15 Class B 10
 Industry Canada ICES-003(B)..... 11
 Dimensions..... 11
 Photometric Data 11

Chapter 3 Specifications

Supply Voltage

18 V DC to 30 V DC

Use only with suitable Class 2 power supply (UL) or a SELV power supply (CE)

Light Length	Typical Current			Maximum Current A
	18 V DC	24 V DC	30 V DC	
145 mm	0.240	0.180	0.150	0.275
285 mm	0.480	0.360	0.300	0.550
430 mm	0.720	0.540	0.450	0.825
570 mm	0.960	0.720	0.600	1.100
850 mm	1.440	1.080	0.900	1.650
1130 mm	1.920	1.440	1.200	2.200

Supply Protection Circuitry

Protected against reverse polarity and transient voltages

Input Rating

Leakage Current Immunity: 400 µA

Indicator On/Off Response Time: 300 ms (maximum)

PWM Duty Cycle Range: 0 to 100%

PFM Frequency Range: 100 to 10000 Hz

Mounting

(2) SMBWLS28RA swivel brackets and (4) screws included

Construction

Housing: Clear anodized aluminum

End Caps: Painted zinc

Polycarbonate window on clear and diffuse plastic models, acrylic window on L25 models

Brackets: Zinc plated steel

Connections

Integral 4-pin M12 male quick-disconnect connector

Environmental Rating

Rated IP50

Vibration and Mechanical Shock

Vibration: 10 Hz to 55 Hz, 1.0 mm peak-to-peak amplitude per IEC 60068-2-6

Shock: 15G 11 ms duration, half sine wave per IEC 60068-2-27

Operating Temperature

-40 °C to +50 °C (-40 °F to +122 °F)

Storage Temperature: -40 °C to +70 °C (-40 °F to +158 °F)

Required Overcurrent Protection



WARNING: Electrical connections must be made by qualified personnel in accordance with local and national electrical codes and regulations.

Overcurrent protection is required to be provided by end product application per the supplied table.

Overcurrent protection may be provided with external fusing or via Current Limiting, Class 2 Power Supply.

Supply wiring leads < 24 AWG shall not be spliced.

For additional product support, go to www.bannerengineering.com.

Supply Wiring (AWG)	Required Overcurrent Protection (A)	Supply Wiring (AWG)	Required Overcurrent Protection (A)
20	5.0	26	1.0
22	3.0	28	0.8
24	1.0	30	0.5

Certifications



Banner Engineering BV
 Park Lane, Culliganlaan 2F bus 3
 1831 Diegem, BELGIUM



Turck Banner LTD Blenheim House
 Blenheim Court
 Wickford, Essex SS11 8YT
 GREAT BRITAIN



Advanced Capabilities



Light Characteristics

RGBW LED PWM Frequency: 2kHz

Color	Dominant Wavelength (nm) or Color Temperature (CCT)	CRI	Color Coordinates ⁽¹⁾		Lumens at Specified Length (Typical at 25 °C) ⁽²⁾					
			X	Y	145 mm	285 mm	430 mm	570 mm	850 mm	1130 mm
Daylight White	5000K	93	0.345	0.352	245	490	735	980	1470	1960
Incandescent White	2700K	42	0.46	0.411	110	220	330	440	660	880
Warm White	3000K	50	0.44	0.404	110	220	330	440	660	880
Fluorescent White	4100K	80	0.376	0.374	205	410	615	820	1230	1640
Neutral White	5700K	86	0.328	0.337	265	530	795	1060	1590	2120
Cool White	6500K	85	0.314	0.324	265	530	795	1060	1590	2120
Green	522	-	0.153	0.704	145	290	435	580	870	1160
Red	620	-	0.688	0.31	55	110	165	220	330	440
Yellow	574	-	0.447	0.488	95	190	285	380	570	760
Blue	467	-	0.14	0.061	40	80	120	160	240	320
Magenta	-	-	0.348	0.155	50	100	150	200	300	400
Cyan	490	-	0.146	0.308	110	220	330	440	660	880
Amber	589	-	0.542	0.417	80	160	240	320	480	640
Rose	-	-	0.486	0.217	50	100	150	200	300	400
Lime Green	562	-	0.376	0.538	110	220	330	440	660	880
Orange	599	-	0.605	0.371	70	140	210	280	420	560
Sky Blue	483	-	0.143	0.213	90	180	270	360	540	720
Violet	-	-	0.223	0.097	45	90	135	180	270	360
Spring Green	505	-	0.15	0.518	130	260	390	520	780	1040

FCC Part 15 Class B

This equipment has been tested and found to comply with the limits for a Class B digital device, pursuant to part 15 of the FCC Rules. These limits are designed to provide reasonable protection against harmful interference in a residential installation. This equipment generates, uses and can radiate radio frequency energy and, if not installed and used in accordance with the instructions, may cause harmful interference to radio communications. However, there is no guarantee that interference will not occur in a particular installation. If this equipment does cause harmful interference to radio or television reception, which can be determined by turning the equipment off and on, the user is encouraged to try to correct the interference by one or more of the following measures:

- Reorient or relocate the receiving antenna.
- Increase the separation between the equipment and receiver.
- Connect the equipment into an outlet on a circuit different from that to which the receiver is connected.
- Consult the dealer or an experienced radio/TV technician for help.

⁽¹⁾ Refer to the CIE 1931 (x,y) Chromaticity Diagram to show equivalent color with indicated color coordinates. Actual coordinates may differ $\pm 5\%$.

⁽²⁾ Lumen values shown apply to diffused models only. Heavy diffused models are 30% lower.

Industry Canada ICES-003(B)

This device complies with CAN ICES-3 (B)/NMB-3(B). Operation is subject to the following two conditions: 1) This device may not cause harmful interference; and 2) This device must accept any interference received, including interference that may cause undesired operation.

Cet appareil est conforme à la norme NMB-3(B). Le fonctionnement est soumis aux deux conditions suivantes : (1) ce dispositif ne peut pas occasionner d'interférences, et (2) il doit tolérer toute interférence, y compris celles susceptibles de provoquer un fonctionnement non souhaité du dispositif.

Dimensions

Dimensions are shown with the included SMBWLS28RA bracket.

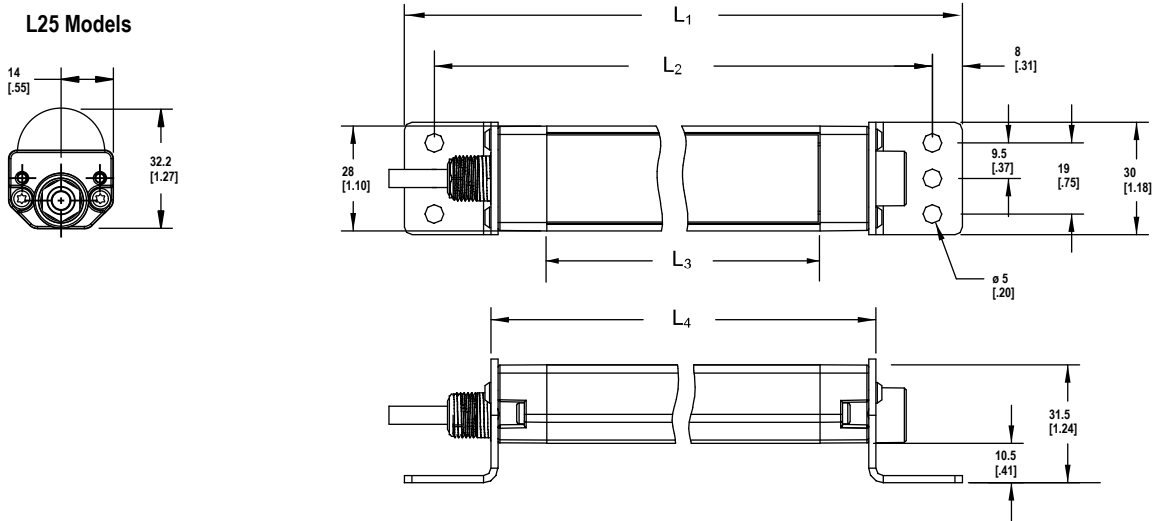

Models	L ₁	L ₂	L ₃	L ₄
WLS28..145..	221 mm (8.7 in)	205 mm (8.1 in)	145 mm (5.71 in)	175 mm (6.9 in)
WLS28..285..	362 mm (14.3 in)	346 mm (13.6 in)	286 mm (11.26 in)	316 mm (12.4 in)
WLS28..430..	503 mm (19.8 in)	487 mm (19.2 in)	427 mm (16.81 in)	457 mm (18.0 in)
WLS28..570..	644 mm (25.4 in)	628 mm (24.7 in)	568 mm (22.36 in)	598 mm (23.5 in)
WLS28..850..	926 mm (36.5 in)	910 mm (35.8 in)	850 mm (33.46 in)	880 mm (34.6 in)
WLS28..1130..	1208 mm (47.6 in)	1192 mm (46.9 in)	1132 mm (44.57 in)	1162 mm (45.7 in)

Photometric Data

Photometric data shown below is for standard clear, and 25° clear window daylight white models only. To get lux and candela values for other colors, multiply the values shown on the charts by the following factors:

Incandescent White: 0.449	Red: 0.224	Rose: 0.204
Warm White: 0.449	Yellow: 0.388	Lime Green: 0.449
Fluorescent White: 0.837	Blue: 0.163	Orange: 0.286
Neutral White: 1.082	Magenta: 0.204	Sky Blue: 0.367
Cool White: 1.082	Cyan: 0.449	Violet: 0.184
Green: 0.592	Amber: 0.327	Spring Green: 0.531

For models with a standard diffused window, multiply lux and candela values by an additional 0.750. Photometric data for 25° diffused lensed models is not shown.

145 mm Models - Clear Window

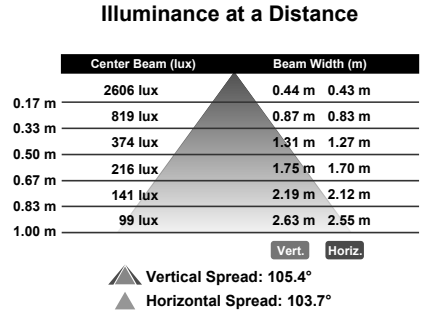
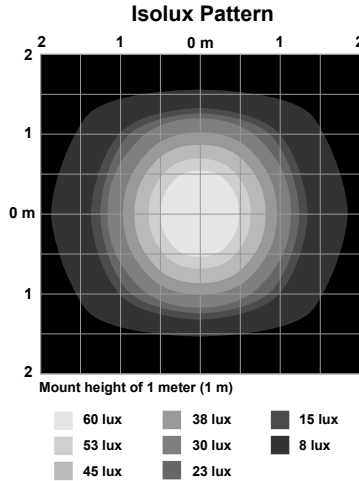
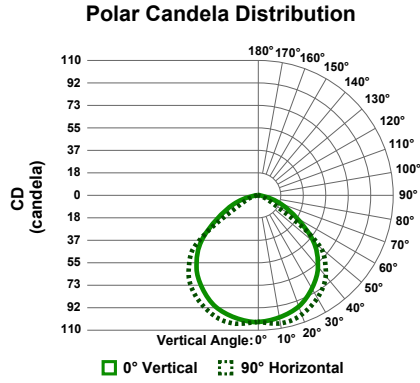

145 mm Models - L25 Window

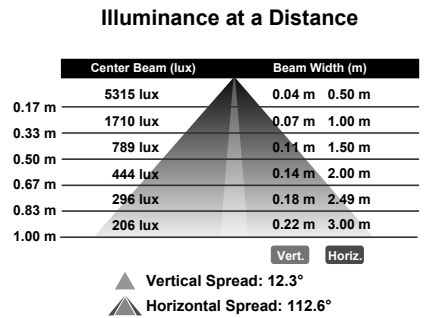
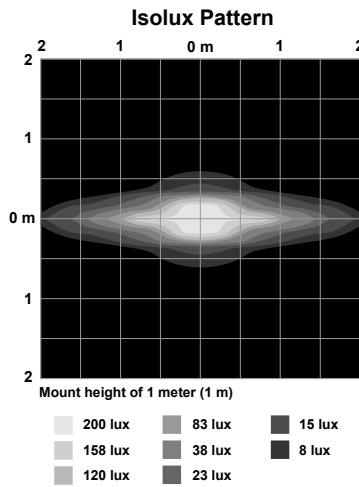
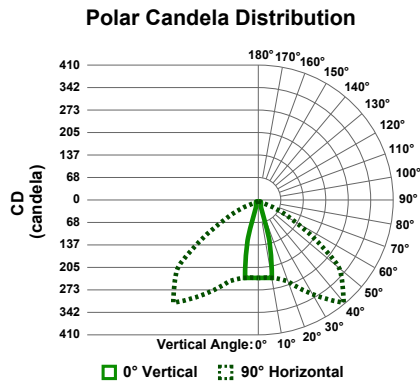

285 mm Models - Clear Window

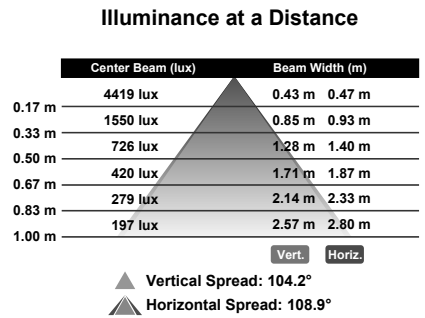
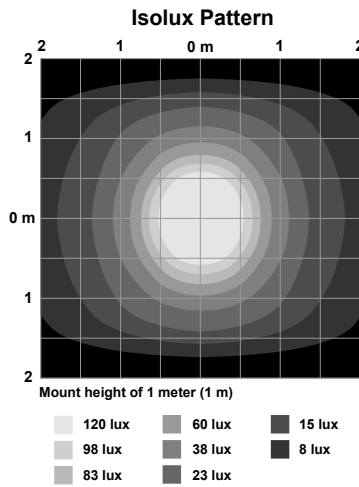
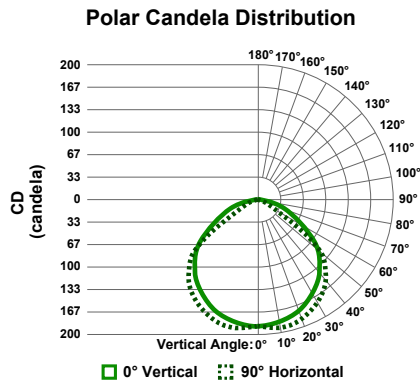

285 mm Models - L25 Window

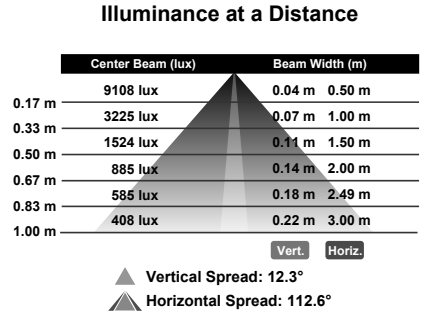
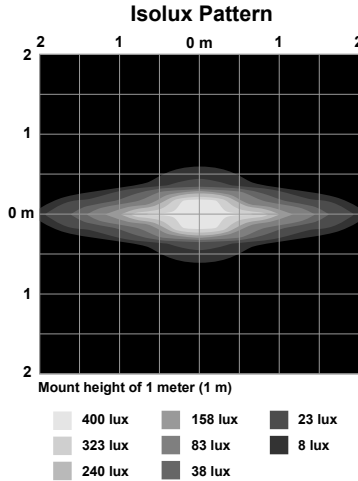
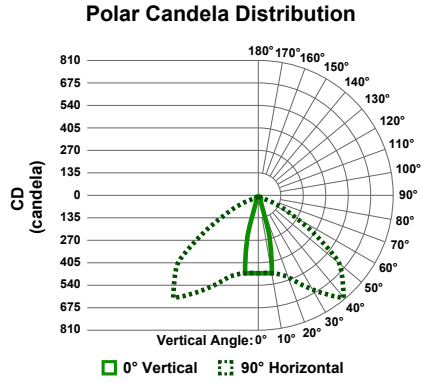

430 mm Models - Clear Window

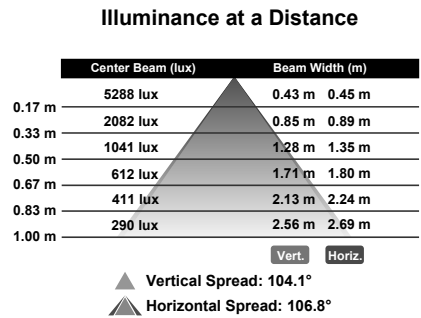
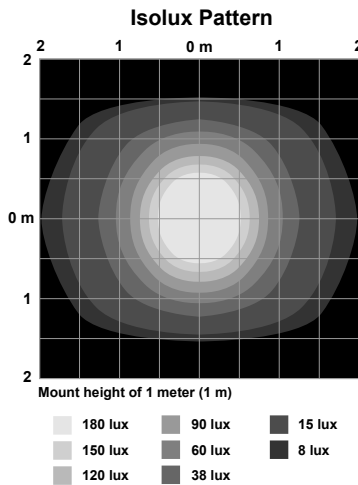
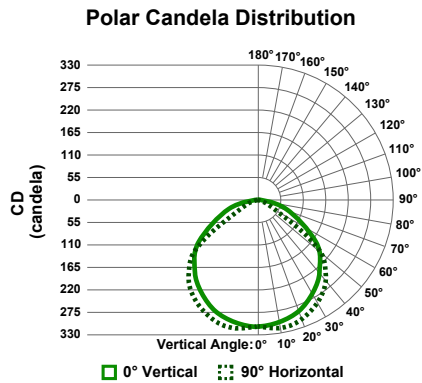

430 mm Models - L25 Window

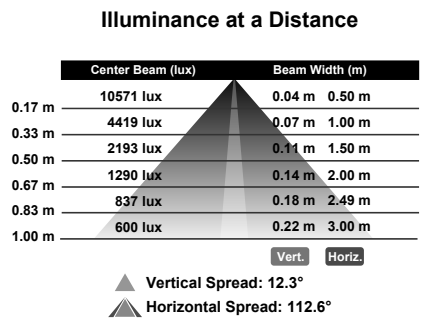
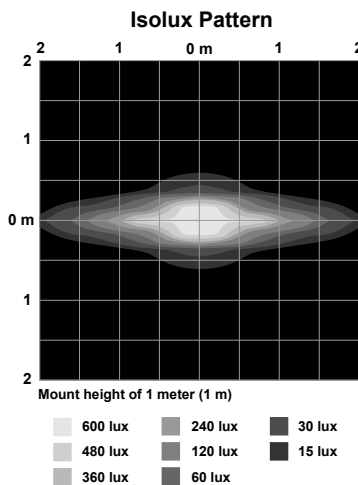
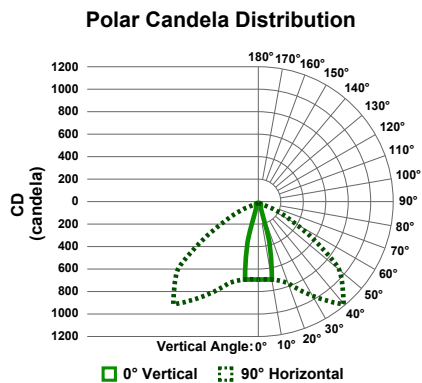

570 mm Models - Clear Window

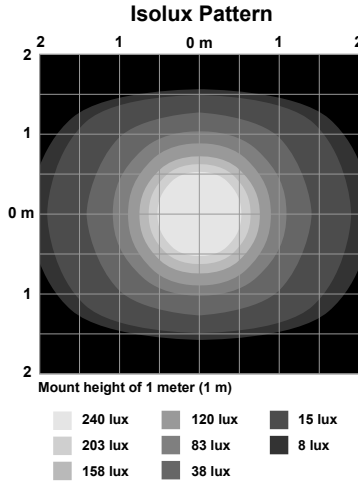
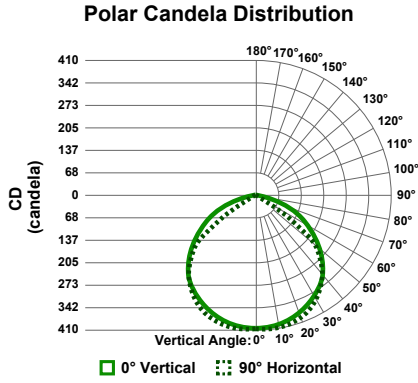

Illuminance at a Distance

Center Beam (lux)	Beam Width (m)
5637 lux	0.42 m 0.49 m
2505 lux	0.83 m 0.97 m
1310 lux	1.25 m 1.47 m
788 lux	1.67 m 1.96 m
536 lux	2.08 m 2.44 m
381 lux	2.50 m 2.93 m

Vert. Horiz.

▲ Vertical Spread: 102.8°
▲ Horizontal Spread: 111.4°

570 mm Models - L25 Window

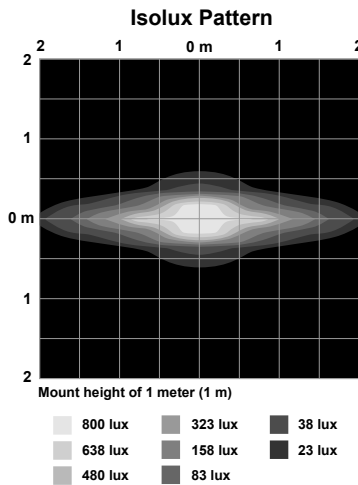
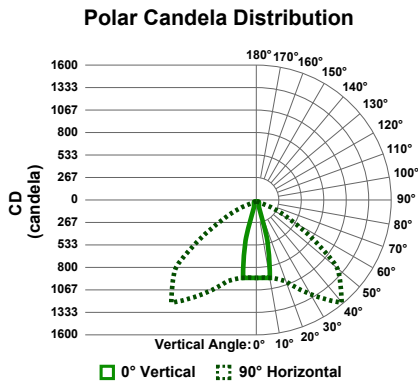

Illuminance at a Distance

Center Beam (lux)	Beam Width (m)
10571 lux	0.04 m 0.50 m
5292 lux	0.07 m 1.00 m
2790 lux	0.11 m 1.50 m
1674 lux	0.14 m 2.00 m
1127 lux	0.18 m 2.49 m
794 lux	0.22 m 3.00 m

Vert. Horiz.

▲ Vertical Spread: 12.3°
▲ Horizontal Spread: 112.6°

850 mm Models - Clear Window

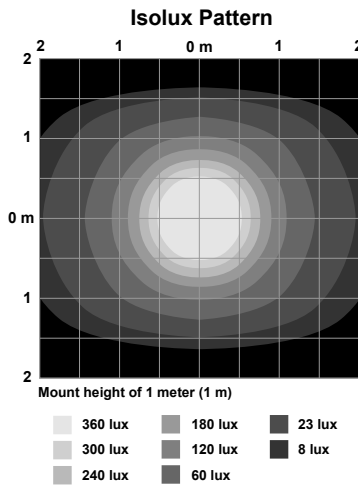
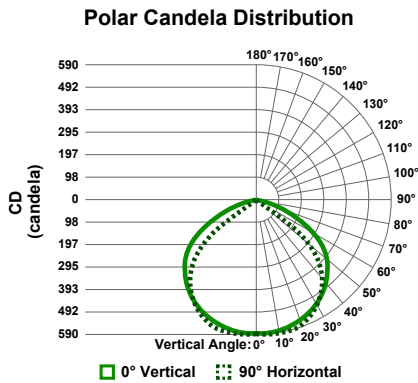

Illuminance at a Distance

Center Beam (lux)	Beam Width (m)
6510 lux	0.41 m 0.52 m
3126 lux	0.81 m 1.03 m
1785 lux	1.21 m 1.56 m
1128 lux	1.62 m 2.08 m
794 lux	2.02 m 2.59 m
578 lux	2.43 m 3.11 m

Vert. Horiz.

▲ Vertical Spread: 101.1°
▲ Horizontal Spread: 114.6°

850 mm Models - L25 Window

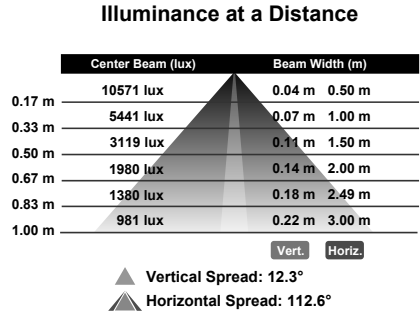
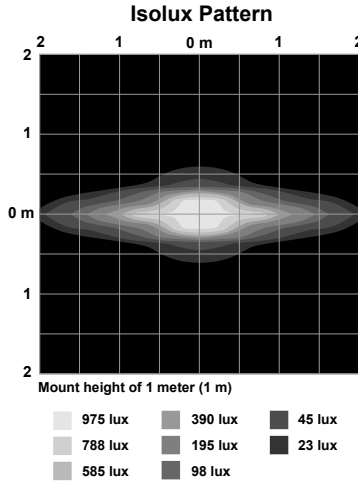
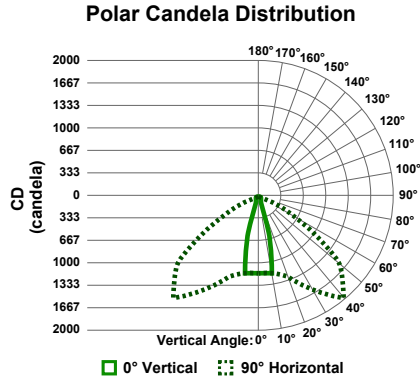

1130 mm Models - Clear Window

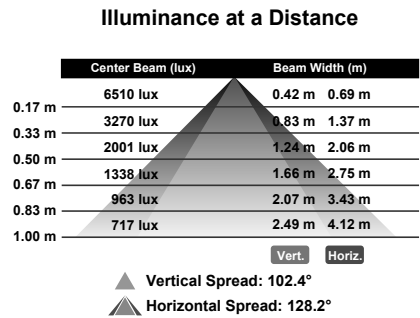
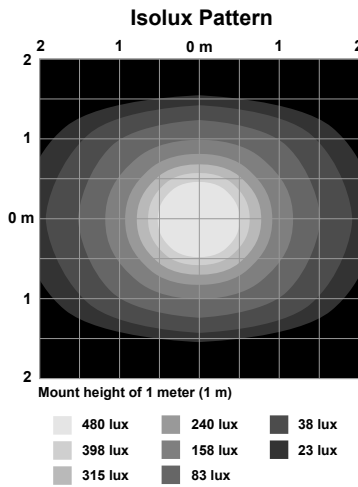
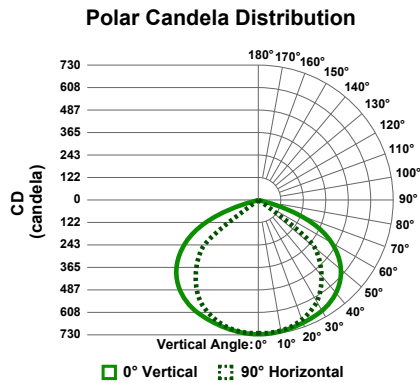

1130 mm Models - L25 Window

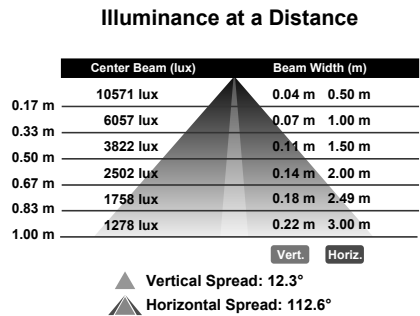
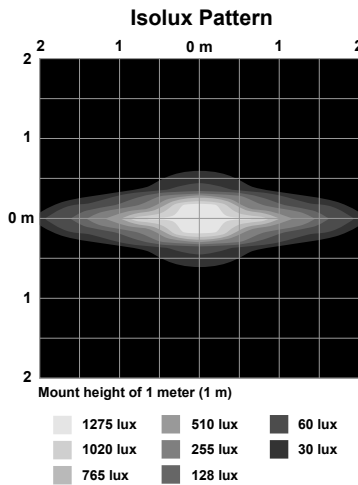
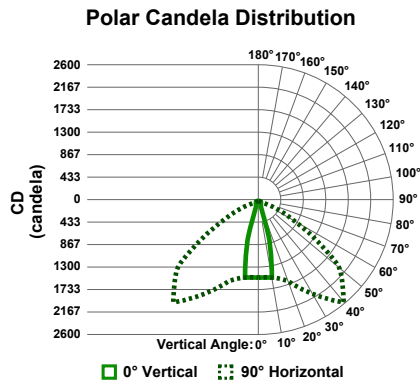

Blank page

Chapter Contents

Cordsets 17
 Brackets 18

Chapter 4 Accessories

Cordsets

PRO-KIT

Includes:

- Pro Converter Cable (MQDC-506-USB)
- Splitter (CSB-M1251FM1251M)
- Power Supply (PSW-24-1)

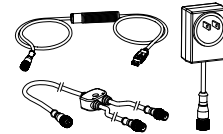

MQDC-506-USB

- Pro Converter Cable
- 1.83 m (6 ft) length 5-pin M12 quick disconnect to Device and USB to PC
- Required for connection to Pro Editor

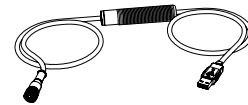

CSB-M1251FM1251M

- 5-pin parallel Y splitter (Male-Male-Female)
- For full Pro Editor preview capability
- Requires external power supply, sold separately

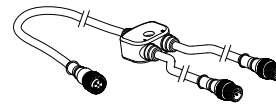

PSD-24-4

- 90 to 264 V AC 50/60 Hz input
- Includes a 1.8 m (6 ft) US style 5-15P input plug
- 24 V DC UL Listed Class 2 M12 connector output
- 4 A total current



LC28PB2-3Q

- In-line switch with M12 connectors
- Rugged metal housing
- Perfect for DC-powered task lights, indicators, and tower lights
- Rated for up to 30 V DC

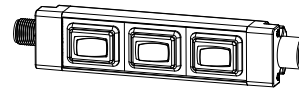

4-Pin Threaded M12 Cordsets—Single Ended

Model	Length	Style	Dimensions	Pinout (Female)
MQDC-406	2 m (6.56 ft)	Straight		
MQDC-415	5 m (16.4 ft)			
MQDC-430	9 m (29.5 ft)			
MQDC-450	15 m (49.2 ft)			
				<p>1 = Brown 2 = White 3 = Blue 4 = Black 5 = Unused</p>

Continued on page 18

Continued from page 17

4-Pin Threaded M12 Cordsets—Single Ended

Model	Length	Style	Dimensions	Pinout (Female)
MQDC-406RA	2 m (6.56 ft)	Right-Angle		
MQDC-415RA	5 m (16.4 ft)			
MQDC-430RA	9 m (29.5 ft)			
MQDC-450RA	15 m (49.2 ft)			

Brackets

SMBWLS28RA

The bracket kit is available as a replacement for the one that comes with the light or switch. The kit contains two end brackets and four screws.

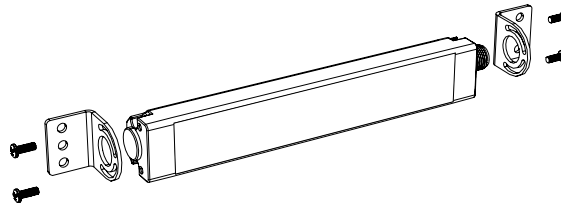
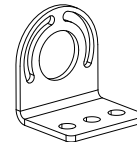

SMBWLS28SM

This kit allows the light or switch to be mounted at a right angle to the mounting surface. The kit contains two end brackets and four screws.

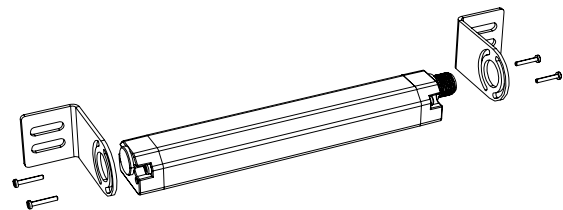

SMBWLS28SP

- Stainless steel snap bracket kit
- Includes two brackets

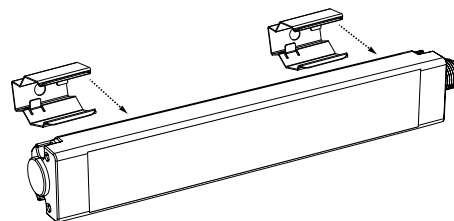
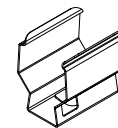

SMH1316

This kit allows the light or switch to be mounted to a 13/16-inch Unistrut channel. Light is shown. The kit includes:

- #10-32 spring nuts (qty 2)
- #10-32 socket head cap screws (qty 2)
- #10 lock washers (qty 2)

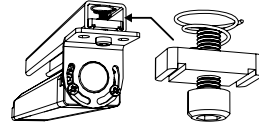

SMBWLSMAG

Magnetic mounting bracket for easy attachment to steel surfaces

SMBWLSMAGR

Protective cover also available to prevent scratches to painted surfaces

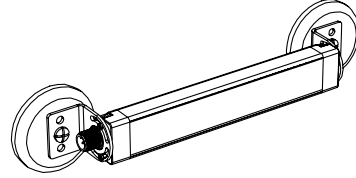

Blank page

Chapter Contents

Mexican Importer..... 21

Chapter 5 Banner Engineering Corp Limited Warranty

Banner Engineering Corp. warrants its products to be free from defects in material and workmanship for one year following the date of shipment. Banner Engineering Corp. will repair or replace, free of charge, any product of its manufacture which, at the time it is returned to the factory, is found to have been defective during the warranty period. This warranty does not cover damage or liability for misuse, abuse, or the improper application or installation of the Banner product.

THIS LIMITED WARRANTY IS EXCLUSIVE AND IN LIEU OF ALL OTHER WARRANTIES WHETHER EXPRESS OR IMPLIED (INCLUDING, WITHOUT LIMITATION, ANY WARRANTY OF MERCHANTABILITY OR FITNESS FOR A PARTICULAR PURPOSE), AND WHETHER ARISING UNDER COURSE OF PERFORMANCE, COURSE OF DEALING OR TRADE USAGE.

This Warranty is exclusive and limited to repair or, at the discretion of Banner Engineering Corp., replacement. **IN NO EVENT SHALL BANNER ENGINEERING CORP. BE LIABLE TO BUYER OR ANY OTHER PERSON OR ENTITY FOR ANY EXTRA COSTS, EXPENSES, LOSSES, LOSS OF PROFITS, OR ANY INCIDENTAL, CONSEQUENTIAL OR SPECIAL DAMAGES RESULTING FROM ANY PRODUCT DEFECT OR FROM THE USE OR INABILITY TO USE THE PRODUCT, WHETHER ARISING IN CONTRACT OR WARRANTY, STATUTE, TORT, STRICT LIABILITY, NEGLIGENCE, OR OTHERWISE.**

Banner Engineering Corp. reserves the right to change, modify or improve the design of the product without assuming any obligations or liabilities relating to any product previously manufactured by Banner Engineering Corp. Any misuse, abuse, or improper application or installation of this product or use of the product for personal protection applications when the product is identified as not intended for such purposes will void the product warranty. Any modifications to this product without prior express approval by Banner Engineering Corp will void the product warranties. All specifications published in this document are subject to change; Banner reserves the right to modify product specifications or update documentation at any time. Specifications and product information in English supersede that which is provided in any other language. For the most recent version of any documentation, refer to: www.bannerengineering.com.

For patent information, see www.bannerengineering.com/patents.

Mexican Importer

Banner Engineering de México, S. de R.L. de C.V. | David Alfaro Siqueiros 103 Piso 2 Valle oriente | San Pedro Garza Garcia Nuevo León, C. P. 66269

81 8363.2714

 [LinkedIn](#)

 [Twitter](#)

 [Facebook](#)



Mouser Electronics

Authorized Distributor

Click to View Pricing, Inventory, Delivery & Lifecycle Information:

[Banner Engineering:](#)

[WLS28PXRGBW285DXQ](#) [WLS28PXRGBW145XQ](#) [WLS28PXRGBW430DXQ](#) [WLS28PXRGBW850XQ](#)