

Opto Interrupter ITR9904



Features

- Fast response time
- High analytic
- Cut-off visible wavelength $\lambda_p=940\text{nm}$
- High sensitivity
- Pb free
- This product itself will remain within RoHS compliant version

Description

- ITR9904 is integrated of infrared emitting diode and NPN silicon phototransistor, encased side-by-side on converging optical axis in a black thermoplastic housing, the interrupter can be used as a switch when receiver part is obscured by objects.

Applications

- Printer
- Stumpers
- Vending machine
- Opto switch

Device Selection Guide

Device No.	Chip Materials	Lens Color
IR	GaAlAs	Blue
PT	Silicon	Black

Absolute Maximum Ratings (Ta=25°C)

Parameter		Symbol	Ratings	Unit
Input	Power Dissipation at(or below) 25°C Free Air Temperature	Pd	50	mW
	Reverse Voltage	V _R	5	V
	Forward Current	I _F	50	mA
	Peak Forward Current (*1) Pulse width ≤ 100μs, Duty cycle=1%	I _{FP}	1	A
Output	Collector Power Dissipation	Pd	75	mW
	Collector Current	I _C	20	mA
	Collector-Emitter Voltage	B V _{CEO}	30	V
	Emitter-Collector Voltage	B V _{ECO}	5	V
Operating Temperature		T _{opr}	-25~+85	°C
Storage Temperature		T _{stg}	-40~+85	°C
Lead Soldering Temperature (*2) (1/16 inch form body for 5 seconds)		T _{sol}	260	°C

(*1) $t_w=100 \mu\text{sec.}$, $T=10 \text{ msec.}$ (*2) $t=5 \text{ Sec}$

Electro-Optical Characteristics (Ta=25°C)

Parameter		Symbol	Min.	Typ.	Max.	Unit	Conditions
Input	Forward Voltage	V_F	---	1.2	1.5	V	$I_F=20mA$
	Reverse Current	I_R	---	---	10	μA	$V_R=5V$
	Peak Wavelength	λ_P	---	940	---	nm	$I_F=20mA$
Output	Dark Current	I_{CEO}	---	---	100	nA	$V_{CE}=20V, E_e=0mW/cm^2$
	C-E Saturation Voltage	$V_{CE(sat)}$	---	---	0.4	V	$I_C=0.1mA$ $I_F=20mA$
Transfer Characteristics	Collect Current	$I_C(on)A$	410	---	1250	μA	$V_{CE}=5V$ $I_F=20mA$
		$I_C(on)B$	830	---	2500		
		$I_C(on)C$	1670	---	5000		
	Rise time	t_r	---	15	---	μsec	$V_{CE}=2V$ $I_C=1mA$ $R_L=1000\Omega$
Fall time	t_f	---	15	---	μsec		

Note: Collect Current Bank use the New standard testing machine

Typical Electrical/Optical/Characteristics Curves for IR

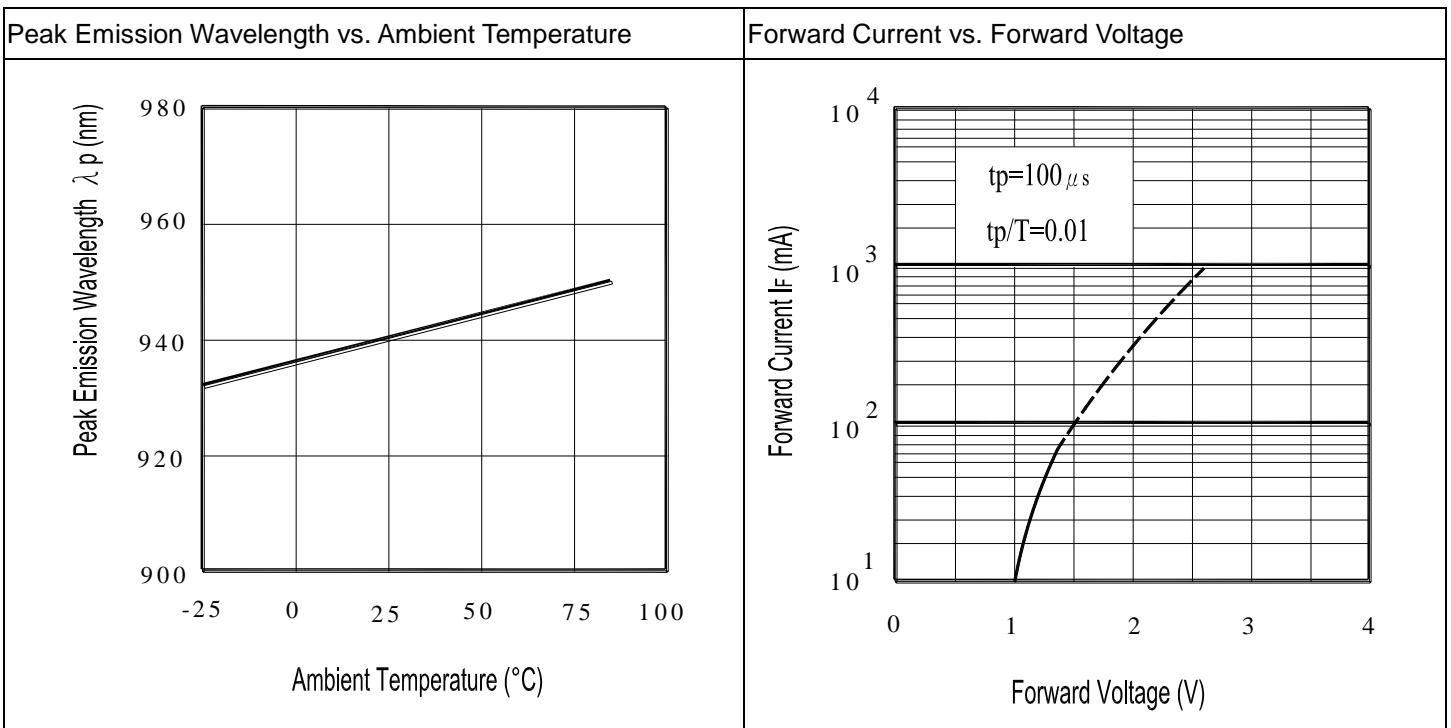
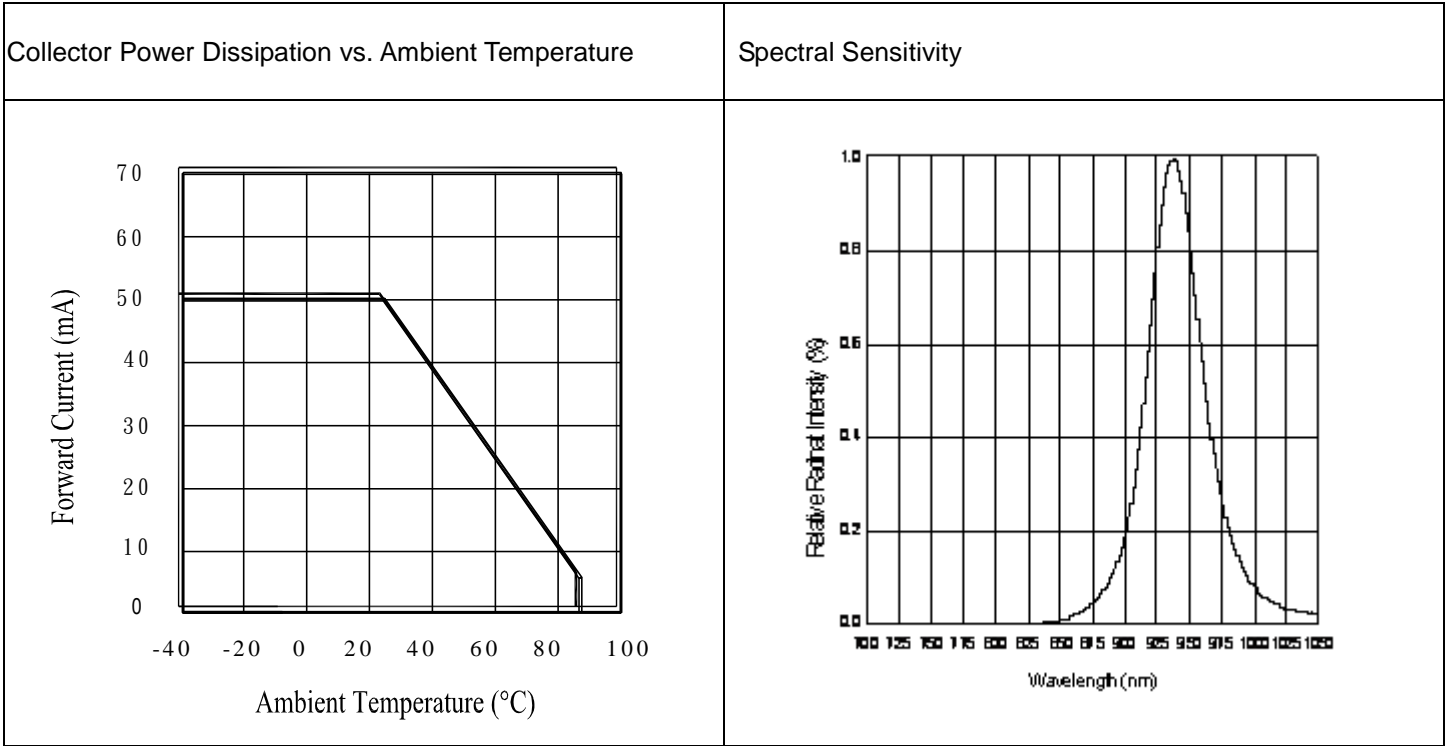

Relative Radiant Intensity vs Forward Current

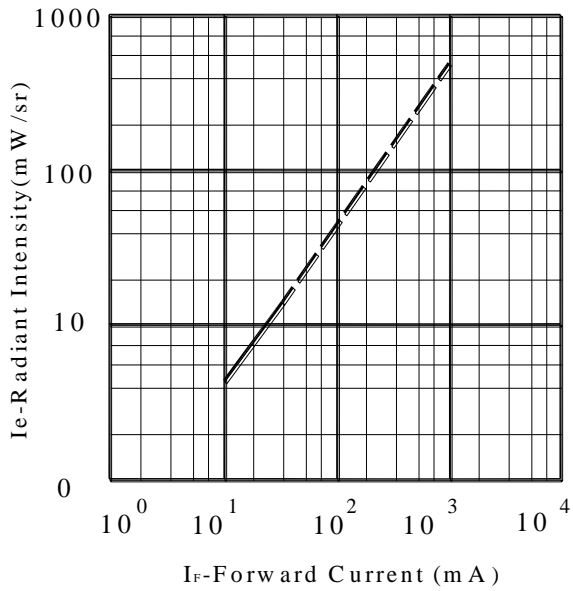

Relative Radiant Intensity vs Angular Displacement

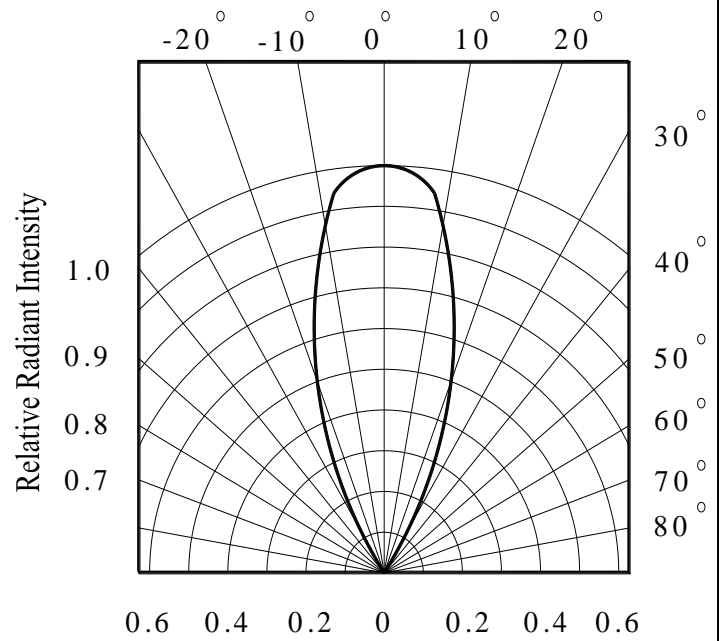

Typical Electrical/Optical/Characteristics Curves for PT

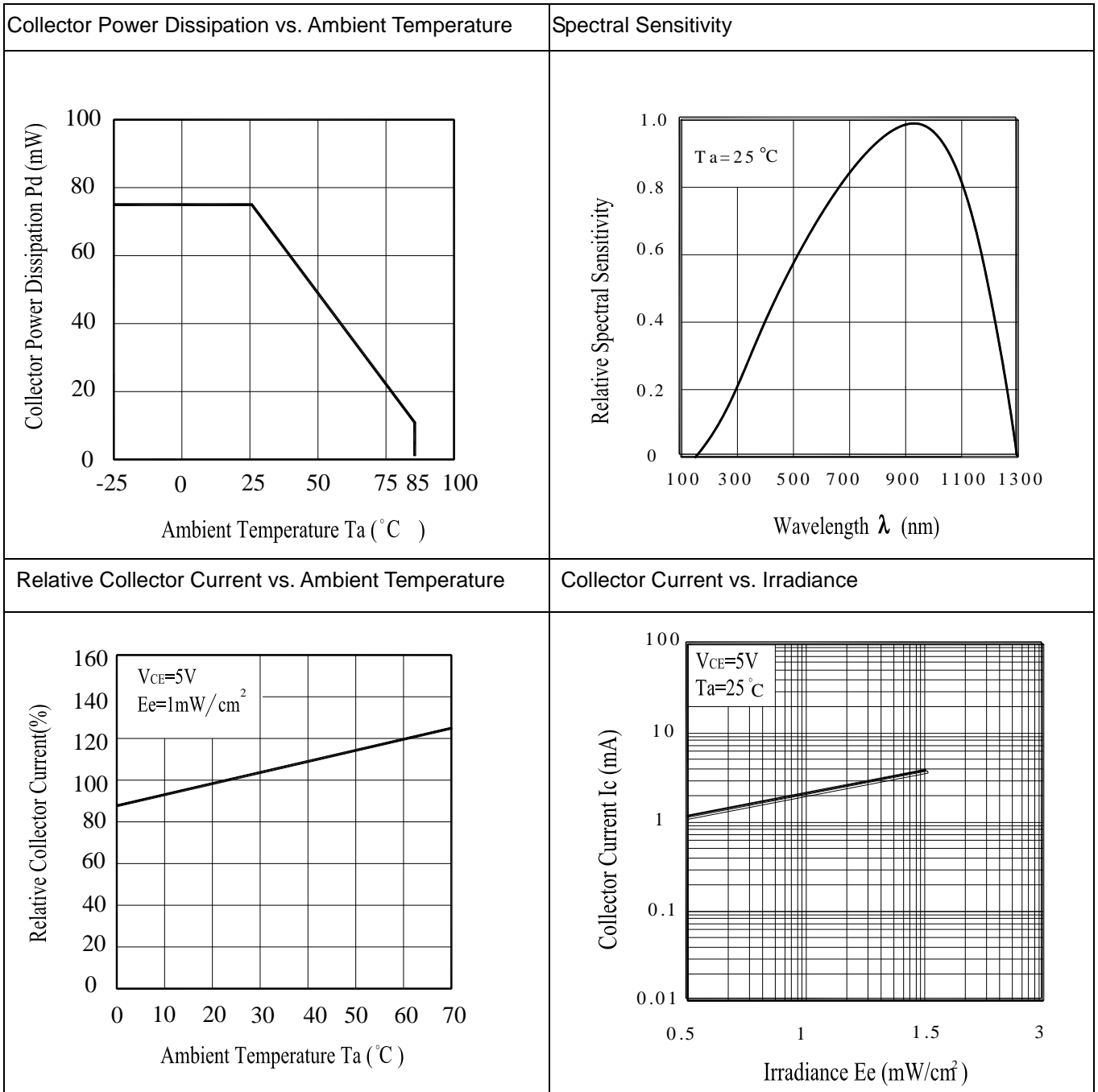

Collector Dark Current vs. Ambient Temperature

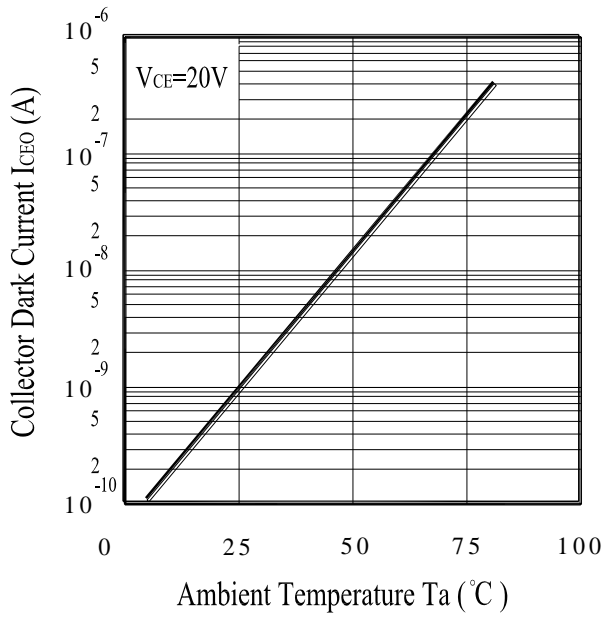

Collector Current vs. Collector-Emitter Voltage

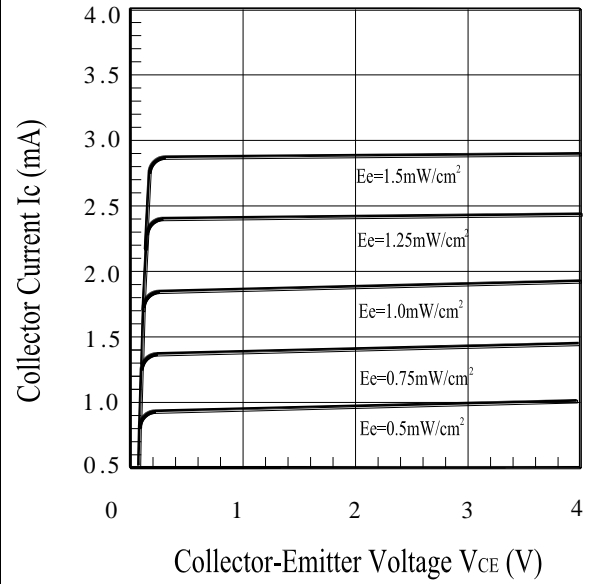

Package Dimension

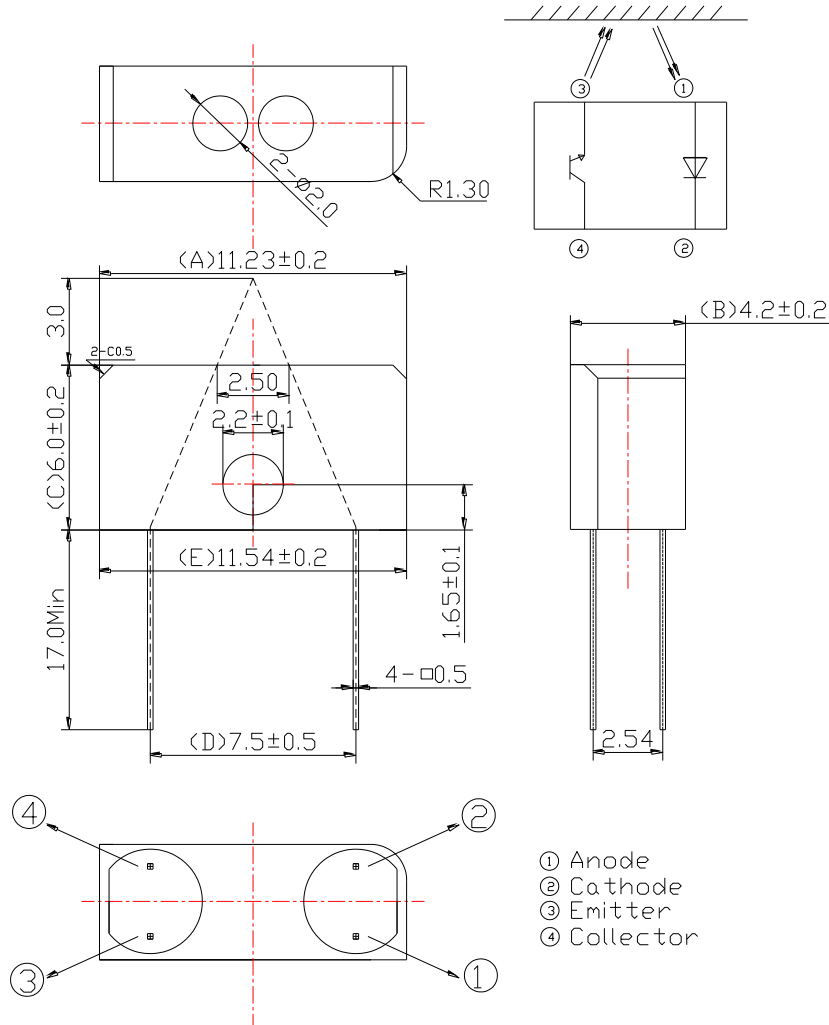

Note: Tolerances unless dimensions ± 0.25 mm

Packing Quantity Specification

1. 150PCS/1Bag, 5Bags/1Box
2. 10Boxes/1Carton

Label Form Specification

Pb	EVERLIGHT	X
CPN: P/N:		
	RoHS	
ITR9904/F399(EO)		
QTY:	CAT:	
	HUE:	
LOT NO:	REF:	
		
Reference		
		

- CPN: Customer's Product Number
- P/N: Product Number
- QTY: Packing Quantity
- CAT: Luminous Intensity Rank
- HUE: Dom. Wavelength Rank
- REF: Forward Voltage Rank
- LOT No: Lot Number
- X: Month
- Reference: Identify Label Number

Notes

1. Above specification may be changed without notice. EVERLIGHT will reserve authority on material change for above specification.
2. When using this product, please observe the absolute maximum ratings and the instruction for using outlined in these specification sheets. EVERLIGHT assumes no responsibility for any damage resulting from use of the product which does not comply with the absolute maximum ratings and the instructions included in these specification sheets.
3. These specification sheets include materials protected under copyright of EVERLIGHT corporation. Please don't reproduce or cause anyone to reproduce them without EVERLIGHT's consent.

Mouser Electronics

Authorized Distributor

Click to View Pricing, Inventory, Delivery & Lifecycle Information:

[Everlight:](#)

[ITR-9904](#)