

ITR8307/F43



Features

- Fast response time
- High sensitivity
- Cut-Off visible wavelength
- Thin
- Compact
- Pb free
- This product itself will remain within RoHS compliant version.
- Compliance with EU REACH
- Compliance Halogen Free(Br < 900ppm, Cl < 900ppm, Br+Cl < 1500ppm)

Description

ITR8307/F43 is a light reflection switch which includes a GaAs IR-LED transmitter and a NPN photo-transistor with a high sensitive receiver for short distance, operating in the infrared range. Both components are mounted side- by- side in a plastic package.

Applications

- Camera
- VCR
- Floppy disk driver
- Cassette type recorder
- Various microcomputer control equipment

Device Selection Guide

Device No.	Chip Material
IR	GaAs
PT	Silicon

Package Dimensions

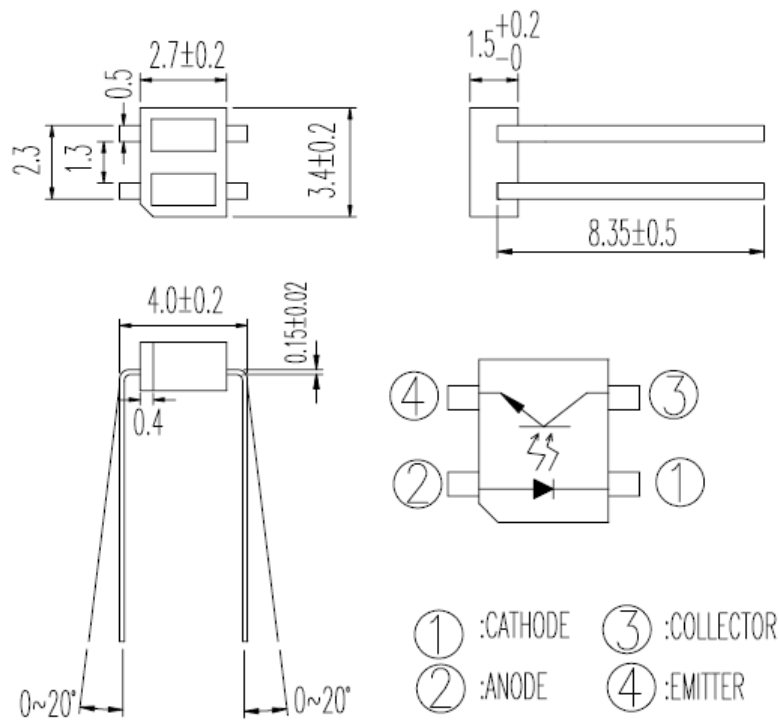

● Notes:

1. All dimensions are in millimeters
2. Tolerances unless dimensions $\pm 0.15\text{mm}$

Absolute Maximum Ratings ($T_a=25^\circ\text{C}$)

Parameter		Symbol	Ratings	Unit
Input	Power Dissipation at(or below) 25 °C Free Air Temperature	P_d	75	mW
	Reverse Voltage	V_R	5	V
	Forward Current	I_F	50	mA
	Peak Forward Current (*1)	I_{FP}	1	A
Output	Collector Power Dissipation	P_C	75	mW
	Collector Current	I_C	50	mA
	Collector-Emitter Voltage	$B V_{CEO}$	30	V
	Emitter-Collector Voltage	$B V_{ECO}$	5	V
Operating Temperature		T_{opr}	-25~+85	°C
Storage Temperature		T_{stg}	-30~+100	°C
Lead Soldering Temperature (*2)		T_{sol}	260	°C

● Notes:

- (*1) $t_w=100\ \mu\text{sec.}$, $T=10\ \text{msec.}$
- (*2) $t=5\ \text{Sec}$

Electro-Optical Characteristics (Ta=25°C)

Parameter	Symbol	Min.	Typ.	Max.	Unit	Conditions	
Input	Forward Voltage	V _F	–	1.2	1.6	V	I _F =20mA
	Reverse Current	I _R	–	–	10	μA	V _R =6V
	Peak Wavelength	λ _p	–	940	–	nm	I _F =20mA
Output	Dark Current	I _{CEO}	–	–	100	nA	V _{CE} =10 V, Ee=0 mW/cm ²
Transfer Characteristics	Collect Current	I _{C(ON)}	0.1	–	–	mA	V _{CE} =5V I _F =20mA
	Leakage Current	I _{CEOD}	–	–	1	nA	V _{CE} =5V I _F =20mA
	Rise time	tr	–	20	–	μs	V _{CE} =2V, I _C =0.1mA, RL=1kΩ, d=1mm
	Rise time	tf	–	20	–	μs	

Typical Electrical/Optical/Characteristics Curves for IR

Fig. 1 Forward Current vs. Ambient Temperature

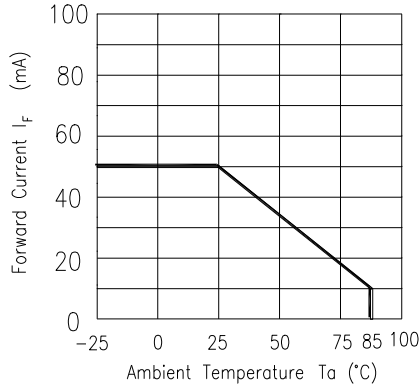

Fig. 2 Spectral Distribution

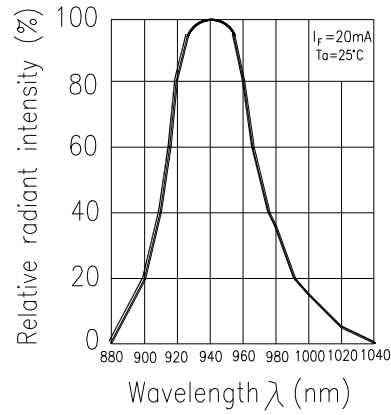

Fig. 3 Peak Emission Wavelength vs. Ambient Temperature

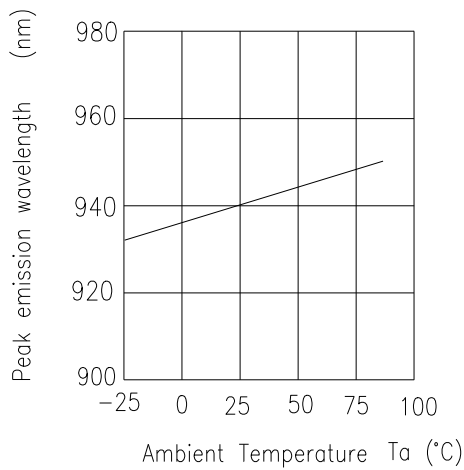

Fig. 4 Forward Current vs. Forward Voltage

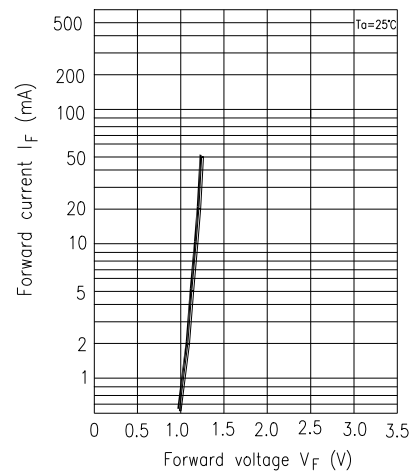

Fig. 5 Forward Voltage vs. Ambient Temperature

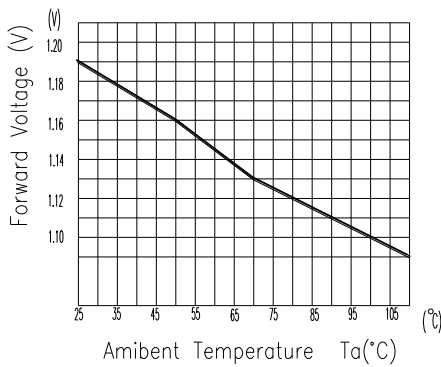
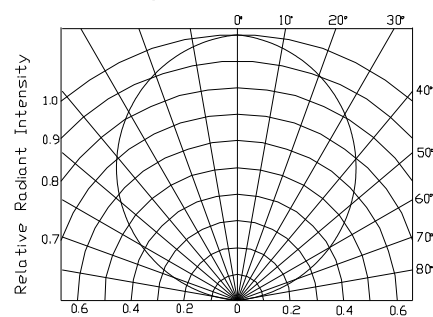

Fig. 6 Relative Radiant Intensity vs. Angular Displacement



Typical Electrical/Optical/Characteristics Curves for PT

Fig.1 Collector Power Dissipation vs. Ambient Temperature

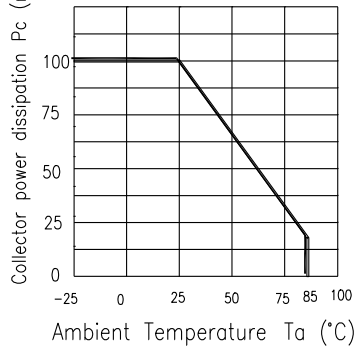

Fig.2 Collector Dark Current vs. Ambient Temperature

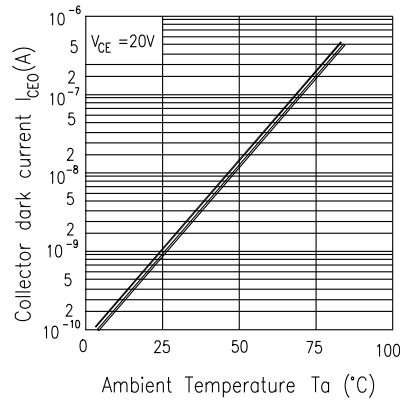

Fig. 3 Relative Collector Current vs. Ambient Temperature

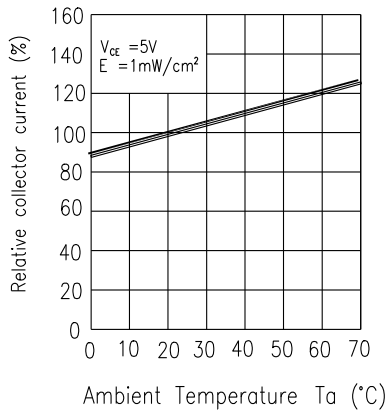

Fig.4 Collector Current vs. Irradiance

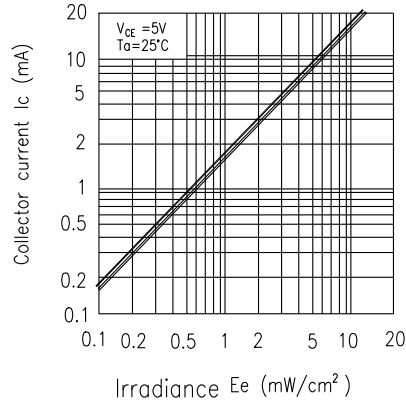

Fig.5 Spectral Sensitivity

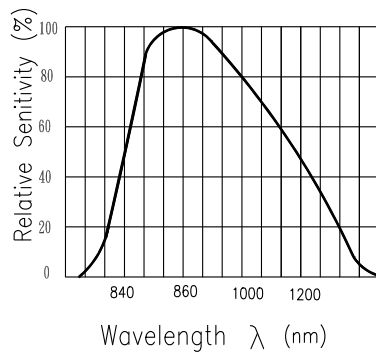
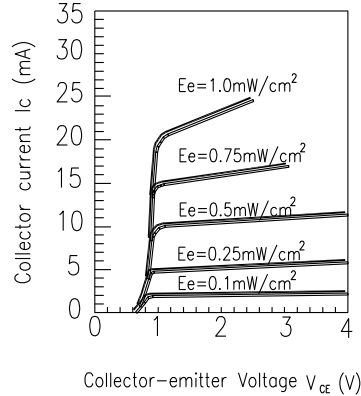

Fig.6 Collector Current vs. Collector-emitter Voltage



Typical Electrical/Optical/Characteristics Curves for ITR

Fig.1 Relative Collector Current vs. Distance between Sensor and Al Evaporation Galss

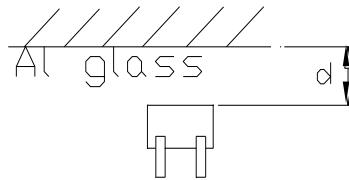
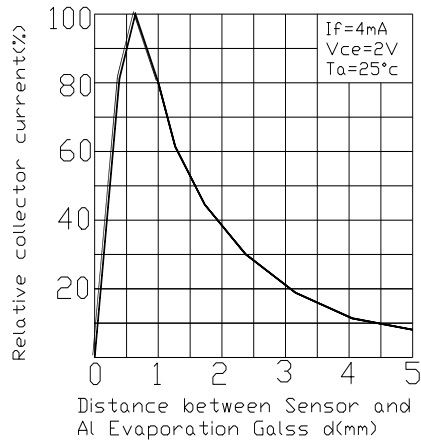

Fig.2 Relative Collector Current vs. Card Moving Distance (l)

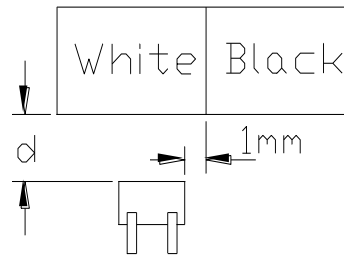
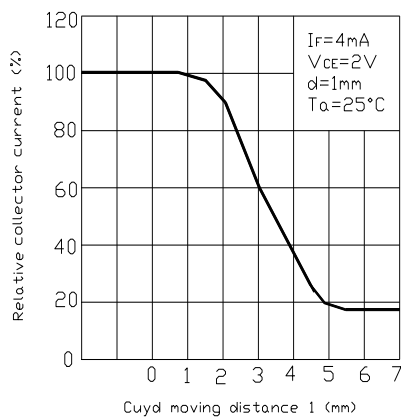
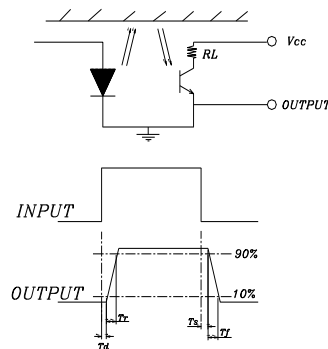
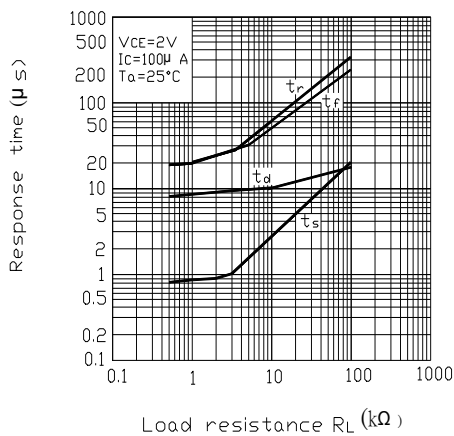

Fig.3 Response Time vs. Load Resistance



Packing Quantity Specification

1. 160 Pcs/ Per Tube
2. 18 Tubes / Inner Carton
3. 12 Inner Cartons / Outside Carton

Label Form Specification



CPN: Customer's Production Number

P/N : Production Number

QTY: Packing Quantity

CAT: Ranks

HUE: Peak Wavelength

REF: Reference

LOT No: Lot Number

MADE IN TAIWAN: Production Place

Recommended Method of Storage

The following are general recommendations for moisture sensitive level (MSL) 4 storage and use :

- Shelf life in sealed bag: 12 months at < 40 °C and < 90% relative humidity (RH)
- After bag is opened, devices that will be subjected to reflow solder or other high temperature process must :
 - a) Mounted within 72 hours of factory conditions < 30 °C/60%RH, or
 - b) b) Stored at <20% RH
- Devices require bake, before mounting, if :
 - Humidity Indicator Card is > 20% when read at 23 ± 5 °C
- If baking is required, devices may be baked :
 - a) 192 hours at 40°C ,and <5% RH(dry air/nitrogen) or
 - b) 96 hours at 60°C ,and <5% RH for all device containersc)
 - c) 24 hours at 125 °C

DISCLAIMER

1. EVERLIGHT reserves the right(s) on the adjustment of product material mix for the specification.
2. The product meets EVERLIGHT published specification for a period of twelve (12) months from date of shipment.
3. The graphs shown in this datasheet are representing typical data only and do not show guaranteed values.
4. When using this product, please observe the absolute maximum ratings and the instructions for using outlined in these specification sheets. EVERLIGHT assumes no responsibility for any damage resulting from the use of the product which does not comply with the absolute maximum ratings and the instructions included in these specification sheets.
5. These specification sheets include materials protected under copyright of EVERLIGHT. Reproduction in any form is prohibited without obtaining EVERLIGHT's prior consent.
6. This product is not intended to be used for military, aircraft, automotive, medical, life sustaining or life saving applications or any other application which can result in human injury or death. Please contact authorized Everlight sales agent for special application request.

Mouser Electronics

Authorized Distributor

Click to View Pricing, Inventory, Delivery & Lifecycle Information:

[Everlight:](#)

[ITR8307/F43](#)