

Technical Data Sheet

0.28" Single Digit Leadframe Display

ELLS-325SURWB/S530-A3

Features

- Industrial standard size.
- Low power consumption.
- Categorized for luminous intensity.
- Pb free
- The product itself will remain with RoHS compliant version.



Descriptions

- The ELLS-325 series is a large 7.0mm (0.28") high seven segment display designed for viewing distances up to 7 meters.
- These displays provide excellent reliability in bright ambient light.
- These devices are made with white segments and gray surface.

Applications

- Audio equipment
- Instrument panels
- Digital read out display

Device Selection Guide

Chip		Face Color
Material	Emitted Color	
AlGaInP	Brilliant Red	Black

Technical Data Sheet

0.28" Single Digit Leadframe Display

ELLS-325SURWB/S530-A3

Package Dimensions

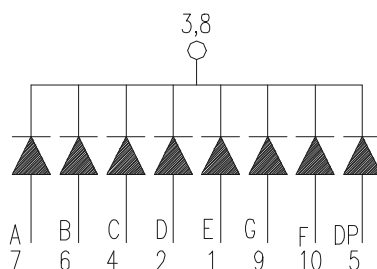
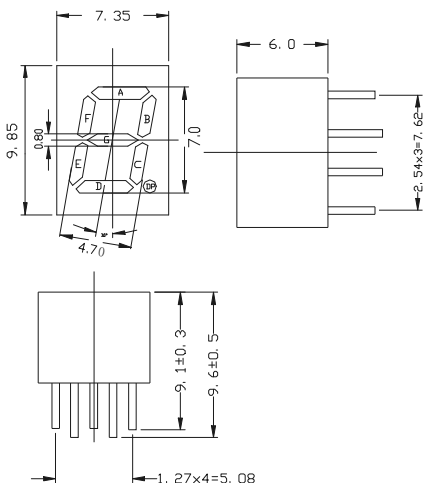

INTERNAL CONNECTION DIAGRM

- 1 ANODE E
- 2 ANODE D
- 3 COMMON CATHODE
- 4 ANODE C
- 5 ANODE DP
- 6 ANODE B
- 7 ANODE A
- 8 COMMON CATHODE
- 9 ANODE G
- 10 ANODE F

- All dimensions are in millimeters, tolerance is 0.25mm unless otherwise noted.
- Above specification may be changed without notice. Supplier will reserve authority on material change for above specification

Absolute Maximum Ratings (Ta=25°C)

Parameter	Symbol	Rating	Units
Forward Current	I _F	25	mA
Pulse Forward Current ^{*1}	I _{FP}	60	mA
Operating Temperature	T _{opr}	-40 ~ +85	°C
Storage Temperature	T _{stg}	-40 ~ +100	°C
Soldering Temperature	T _{sol}	260	°C
Electrostatic Discharge	ESD	2000	V
Power Dissipation	P _d	60	mW
Reverse Voltage	V _R	5	V

Notes: *Soldering time ≤ 5 seconds.

Technical Data Sheet

0.28" Single Digit Leadframe Display

ELLS-325SURWB/S530-A3

Electro-Optical Characteristics (Ta=25°C)

Parameter		Symbol	Min.	Typ.	Max.	Units	Condition
Forward Voltage		V_F	--	2.0	2.4	V	$I_F=20mA$
Reverse Current		I_R	--	--	10	μA	$V_R=5V$
Luminous Intensity	Per segment	I_V	5.6	15.0	--	mcd	$I_F=10mA$
	Per decimal point		2.3	5.7	--		
Peak Wavelength		λ_p	--	632	--	nm	$I_F=20mA$
Dominant Wavelength		λ_d	--	624	--	nm	$I_F=20mA$
Spectrum Radiation Bandwidth		$\Delta \lambda$	--	20	--	nm	$I_F=20mA$

Bin Range of Luminous Intensity (Unit: mcd)

Rank	Min.	Max.	Rank	Min.	Max.
P	5.6	8.9	S	15.0	24.0
Q	7.8	12.5	T	21.0	34.0
R	11.0	17.6	U	30.0	48.0

Technical Data Sheet

0.28" Single Digit Leadframe Display

ELLS-325SURWB/S530-A3

Typical Electro-Optical Characteristics Curves

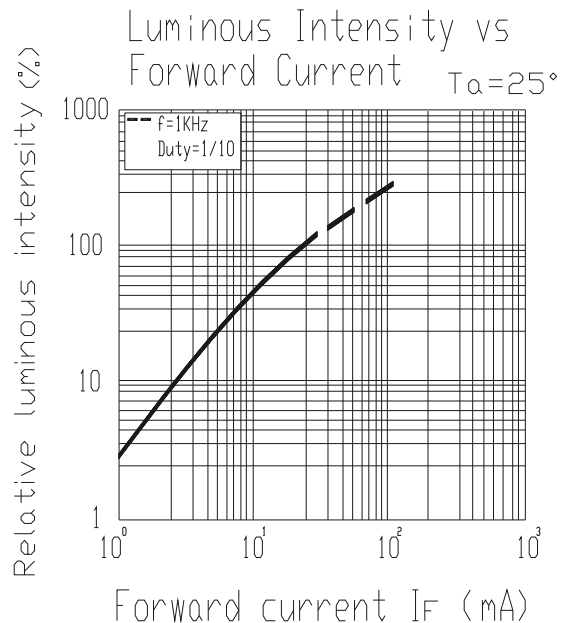
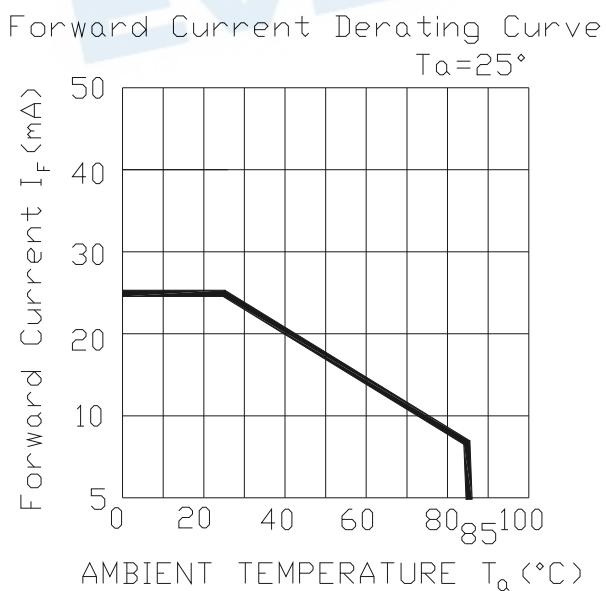
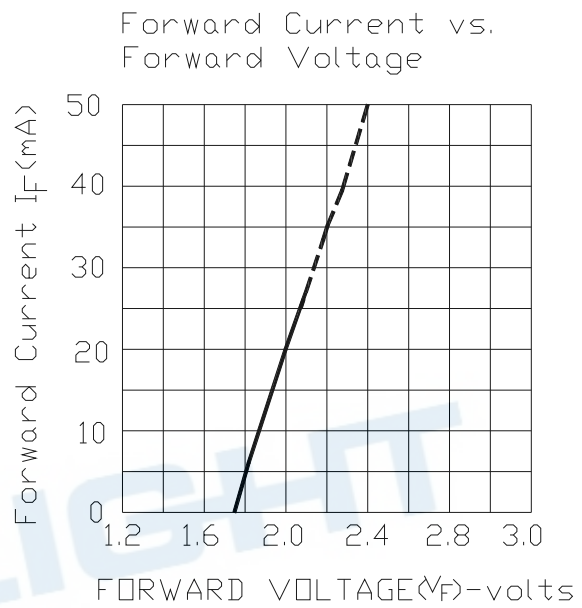
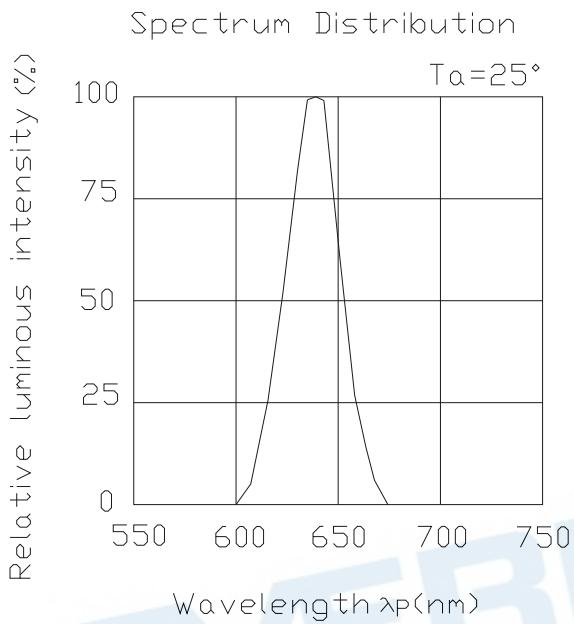

Technical Data Sheet

0.28" Single Digit Leadframe Display

ELLS-325SURWB/S530-A3

■ Reliability test items and conditions:

The reliability of products shall be satisfied with items listed below.

Confidence level : 90%

LTPD : 10%

NO	Item	Test Conditions	Test Hours/Cycle	Sample Size	Failure Judgment Criteria	Ac/Re
1	Solder Heat	Temp : 260°C ± 5°C	5 sec.	22 PCS	$I_v \leq I_{vt} * 0.5$ or $V_f \geq U$ or $V_f \leq L$	0/1
2	Temperature Cycle	H : +85°C 15min. ↓ 5min. L : -40°C 15min.	50 cycles	22 PCS		0/1
3	Thermal Shock	H : +100°C 5min. ↓ 10sec. L : -10°C 5min.	50 cycles	22 PCS		0/1
4	High Temperature Storage	Temp : 100°C	1000 hrs.	22 PCS		0/1
5	Low Temperature Storage	Temp : -40°C	1000 hrs.	22 PCS		0/1
6	DC Operating Life	$I_F = 10\text{mA}$ ($T_a = 25^\circ\text{C}$)	1000 hrs.	22 PCS		0/1
7	High Temperature / High Humidity	85°C / 85% RH	1000 hrs.	22 PCS		0/1

Note : I_{vt} : The test I_v value of the chip before the reliability test

I_v : The test value of the chip that has completed the reliability test

U : Upper Specification Limit

L : Lower Specification Limit

Technical Data Sheet





0.28" Single Digit Leadframe Display

ELLS-325SURWB/S530-A3

Packing Quantity Specification

- 1.50PCS/tube,10tubes/box
- 2.16 Boxes/Carton

Label Form Specification

	EVERLIGHT	11
CPN:		
P/N:		
		RoHS
LS325SURWB/S530-A3		
QTY:	CAT:	
	HUE:	
	REF:	
LOT NO:		
		
REFERENCE:		
		DC:

CPN: Customer's Production Number

S/N : Production Number

QTY: Packing Quantity

CAT: Ranks

HUE: Peak Wavelength

REF: Reference

LOT No: Lot Number

DC: Year and weekly

REFERENCE: Label identify code

Notes :

1. Above specification may be changed without notice. EVERLIGHT will reserve authority on material change for above specification.
2. When using this product, please observe the absolute maximum ratings and the instructions for using outlined in these specification sheets. EVERLIGHT assumes no responsibility for any damage resulting from use of the product which does not comply with the absolute maximum ratings and the instructions included in these specification sheets.
3. These specification sheets include materials protected under copyright of EVERLIGHT Corporation. Please don't reproduce or cause anyone to reproduce them without EVERLIGHT's consent.

EVERLIGHT ELECTRONICS CO., LTD.

Tel: 886-2-2267-2000, 2267-9936

Office: No 25, Lane 76, Sec 3, Chung Yang Rd,

Fax: 886-2-2267-6244, 2267-6189, 2267-6306

Tucheng, Taipei 236, Taiwan, R.O.C

<http://www.everlight.com>

Mouser Electronics

Authorized Distributor

Click to View Pricing, Inventory, Delivery & Lifecycle Information:

[Everlight:](#)

[LS325SURWB/S530-A3](#)