

# GENERAL CATALOG

① Electronics in the Control Cabinet

② Interfaces

③ Connection Technology

④ I/O Systems

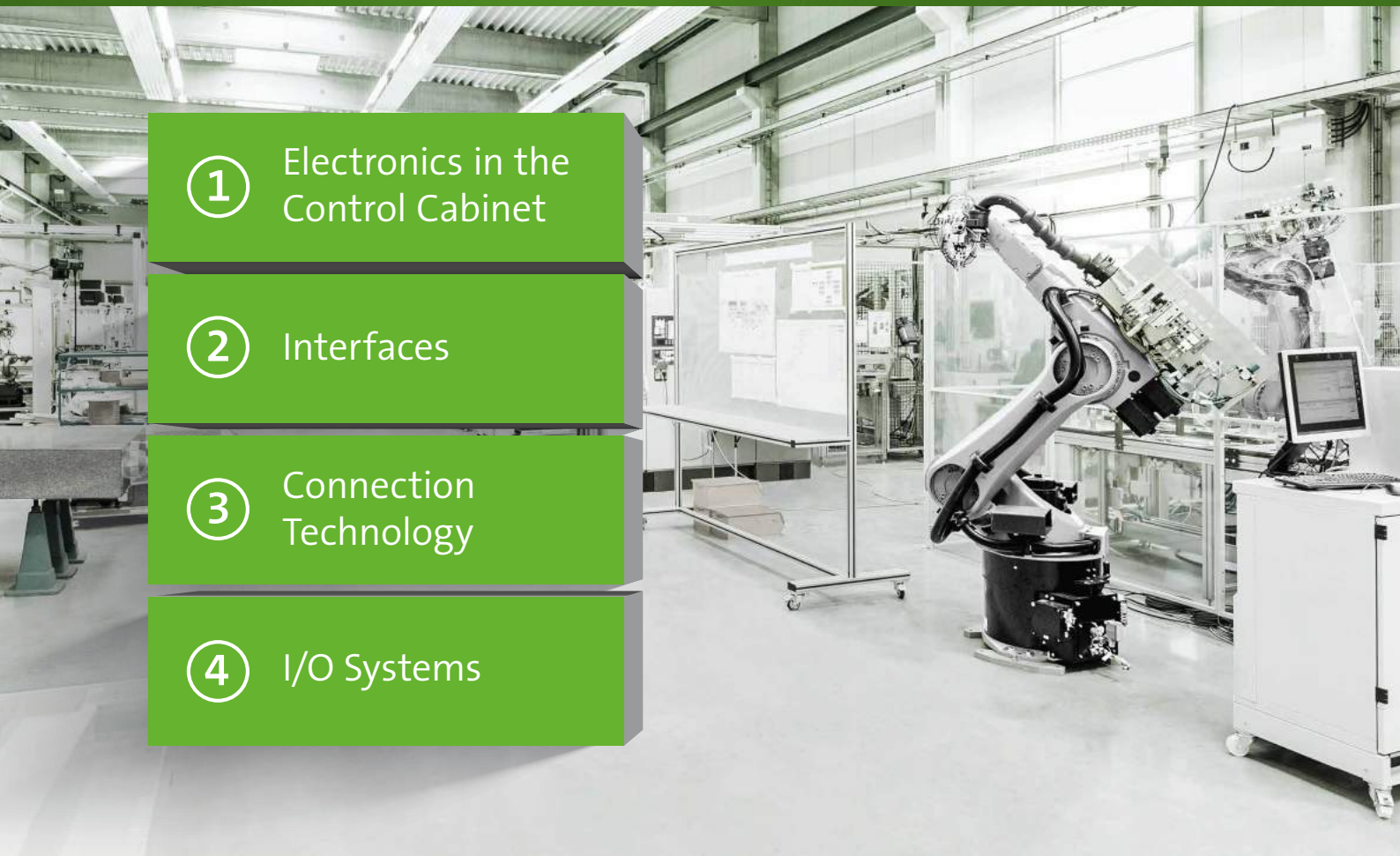

# **GENERAL CATALOG**

## Note:

With this new main catalog, all information contained in previous brochures/catalogs expires. All drawings, diagrams, indications of weight, dimensions, ratings or other details printed in this catalog are only binding when specifically agreed upon.

Murrelektronik reserves the right to changes and modifications. The customer is responsible for using the components and units that they ordered in the way they are designed.

The information in this brochure has been compiled with the utmost care. Liability for the correctness, completeness and topicality of the information is restricted to gross negligence.

1<sup>st</sup> edition: January 2019

Part No. 9800012

Murrelektronik GmbH,  
Falkenstr. 3, D-71570 Oppenweiler

[www.murrelektronik.com](http://www.murrelektronik.com)

## With compliments:

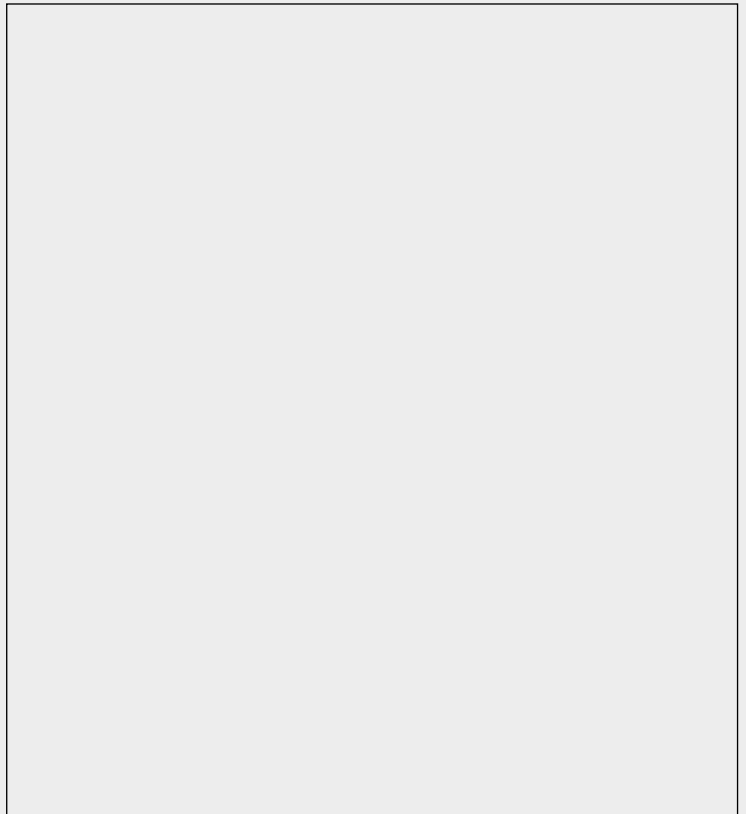

# MURRELEKTRONIK GOES EVEN GREENER!



Being sustainable and respecting nature are part of our core values here. That's why we print our catalogs on uncoated paper which is produced without any solvents, chlorine and is environmentally friendly. Our supply chain is also an environmentally friendly production process.

We, here at Murrelektronik, are proud to say we act responsibly and protect the environment.



# 1

## ELECTRONICS IN THE CONTROL CABINET

- 1.1 Transformers / Rectified Power Supplies
- 1.2 Power Supply Units
- 1.3 UPS-Systems / Buffer- / Redundancy Modules
- 1.4 Intelligent Power Distribution
- 1.5 Converters / Rectifiers
- 1.6 Control Cabinet Power Outlets
- 1.7 EMC Filters
- 1.8 EMC Suppressors
- 1.9 Relays / Safety Relays
- 1.10 Optocouplers / Semiconductors
- 1.11 Switches
- 1.12 Active Interface Technology
- 1.13 Passive Interface Technology
- 1.14 Eurocard Holders / Control Modules



# 2

## INTERFACES

- 2.1 Front Panel Interfaces
- 2.2 Control Cabinet Interfaces / Cable Entry Systems
- 2.3 Hybrid Fieldbus Coupling
- 2.4 Lighting Elements
- 2.5 Control Devices
- 2.6 Modular Connection Systems (Modlink Vario)
- 2.7 Heavy Duty Connectors (Modlink Heavy)



**3****CONNECTION TECHNOLOGY**

- 3.1 M8 Round Plug Connectors
- 3.2 M12 Round Plug Connectors
- 3.3 T-couplers M8, M12, 7/8"
- 3.4 Flange Connectors
- 3.5 MQ12 Round Plug Connectors
- 3.6 Fieldbus Connectors
- 3.7 Plug Connectors for Food & Beverage
- 3.8 Mobile Applications
- 3.9 M23 Round Plug Connectors
- 3.10 Round Plug Connectors Power
- 3.11 TPE Series – The North American standard
- 3.12 Valve Connectors
- 3.13 Technical Appendix Cables

**4****I/O SYSTEMS**

- 4.1 Cube67
- 4.2 Cube20
- 4.3 Cube20S
- 4.4 MVK Metal
- 4.5 SOLID67
- 4.6 Impact67
- 4.7 IO-Link Devices
- 4.8 MASI Control Cabinet
- 4.9 MASI Field Installation
- 4.10 MASI Installation Technology
- 4.11 M8 Distribution Systems
- 4.12 M12 Distribution Systems (Metal)
- 4.13 M12 Distribution Systems (Plastic)





**26 BRANCH OFFICES  
AND 5 PRODUCTION PLANTS**

**Oppenweiler**  
Production Fieldbus Systems

**Stollberg, Germany**  
Production of Connectors

**Stod, Czech Republic**  
Production of Interface,  
Switch Mode Power Supplies,  
Transformers

**Shanghai, China**  
Production for the  
Asian markets



**STAY CONNECTED – REPRESENTED  
ON ALL CONTINENTS WORLDWIDE**

The company was founded in 1975 by Franz Hafner

Over 2,700 employees, including 250 sales reps and customer service center technicians

Top student training is very important for Murrelektronik. Each year we offer apprenticeships in technical and commercial areas, as well as in logistics.



# MURRELEKTRONIK FIGURES & FACTS

**Atlanta, USA**  
Production of Connectors



## MURRELEKTRONIK IS YOUR PARTNER...

- Over 65,000 products available to order conveniently in our online shop
- Subdivided into four product fields:
  - **Electronics in the Control Cabinet**
  - **Interfaces**
  - **Connection Technology**
  - **I/O Systems**
- For industries and market segments as for example:
  - **Machine Tools**
  - **Machine Building and Plant Engineering**
  - **Assembly and Handling Technology**
  - **Food and Beverage**
  - **Automotive Industry**
  - **Warehousing and Logistics**
  - **Robotic**
- Founded in Oppenweiler, Germany, in 1975
- Family-owned company





**CUSTOMER  
LOYALTY WITH  
INDIVIDUAL  
AND  
COMPETENT  
ON-SITE HELP**

## MURRELEKTRONIK OFFER VALUABLE BENEFITS

- Over 250 sales reps
- On-site support
- 5 international warehouses
- 1 million products in stock

- Murrelektronik Express Service

**mex**  
More service

# MURRELEKTRONIK YOUR BENEFITS



International approvals for  
flexible applications worldwide

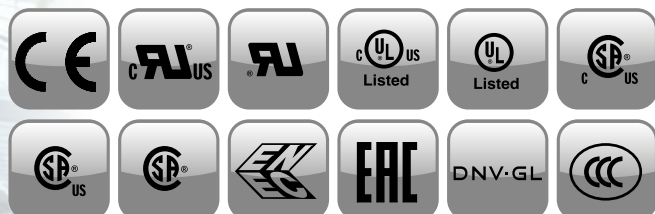

# MURRELEKTRONIK QUALITY



## MURRELEKTRONIK STANDS FOR QUALITY

- In-house test center and EMC lab for tested and accredited products
- Individual and competent on-site advice and support
- No use of hazardous materials
- Complies with RoHS requirements
- First-class design and production quality
- Systematic and sustainable quality management according to DIN EN ISO 9001

Tested and accredited:  
In-house test center  
and EMC laboratory



Endurance tests  
under extreme  
conditions



Product testing begins  
at the beginning of the  
project





**connec+ivity®**  
by Murrelektronik

## THE BACK BONE OF YOUR MACHINE AND SYSTEM INSTALLATIONS

### ASSESSING STATUS

- On-site analysis
- Exchanging the basic documentation
- Discussing the current status

### SELECTING THE DESIGN

- Concept overview
- Analyzing advantages and disadvantages
- Bills of materials

### CREATING A CONCEPT

- Customer-specific requirements
- Industry-specific requirements
- Several concept options

### PROJECT SUPPORT

- E-plan and CAD data
- Electronic catalog data (BMEcat)
- Setup support



# CONNECTIVITY BY MURRELEKTRONIK

## CONNECTIVITY MEANS INDIVIDUAL SOLUTIONS

- Best advice increases your competitive advantage
- Decrease your budget significantly
- We optimize your machine and system installation
- Highly skilled, specially trained staff
- Individual system solutions
- Consistent from a single source

## SYSTEM ADVICE WITH CONNECTIVITY CITY

Go from the industry overview  
to your application ...



... to the appropriate products.



# MURRELEKTRONIK REPRESENTED ON ALL CONTINENTS WORLDWIDE



## GERMANY

Murrelektronik GmbH  
Falkenstraße 3  
D-71570 Oppenweiler  
Phone +49 7191 47-0  
Fax +49 7191 47-491000  
info@murrelektronik.de  
www.murrelektronik.de



## ARGENTINA

NAKASE SRL  
ventas@nakase.com  
www.nakase.com.ar



## AUSTRALIA

Sick Pty. Ltd.  
sales@sick.com.au  
www.sick.com.au



## AUSTRIA

Murrelektronik GmbH Austria  
info@murrelektronik.at  
www.murrelektronik.at



## BELGIUM

Murrelektronik B.V.B.A.  
info@murrelektronik.be  
www.murrelektronik.be



## BRAZIL

Murrelektronik do Brasil  
Indústria e Comércio Ltda.  
info@murrelektronik.com.br  
www.murrelektronik.com.br



## BOSNIA HERZEGOVINA

Murrelektronik GmbH Austria  
info@murrelektronik.at  
www.murrelektronik.at



## BULGARIA

Murrelektronik GmbH Austria  
info@murrelektronik.at  
www.murrelektronik.at



## CANADA

Murrelektronik Canada  
info@murrelektronik.ca  
www.murrelektronik.ca



## CHILE

Electrónica Rhomberg Ltda.  
info@rhomberg.cl  
www.rhomberg.cl



## CHINA

Murrelektronik Components Co. Ltd.  
info@murrelektronik.com.cn  
www.murrelektronik.com.cn



## CROATIA

Murrelektronik GmbH Austria  
info@murrelektronik.at  
www.murrelektronik.at



## CZECH REPUBLIC

Murrelektronik CZ spol. s.r.o.  
info@murrelektronik.cz  
www.murrelektronik.cz



## DENMARK

Murrelektronik ApS  
info@murrelektronik.dk  
www.murrelektronik.dk



## EGYPT

DANA Import & Export  
usama@dana-egy.com  
www.murrelektronik.com/en



## FINLAND

Murrelektronik Power Oy  
info@murrelektronik.fi  
www.murrelektronik.fi



## FRANCE

Murrelektronik S.A.S.  
info@murrelektronik.fr  
www.murrelektronik.fr



## GREAT BRITAIN

Murrelektronik Ltd.  
info@murrelektronik.co.uk  
www.murrelektronik.uk



## HUNGARY

Murrelektronik Kft.  
info@murrelektronik.hu  
www.murrelektronik.hu



## ISLAND

Reykjafell hf  
reykjafell@reykjafell.is  
www.reykjafell.is



## INDIA

Murrelektronik Pvt. Ltd.  
info@murrelektronik.in  
www.murrelektronik.in



## INDONESIA

Murr Asia-Pacific Pte. Ltd.  
sales@murrelektronik.sg  
www.murrelektronik.sg



## IRAN

Shahin Power and Industry Co.  
info@shahin-co.ir  
www.shahin-co.ir



## ISRAEL

O.M.S.T Marketing & Import Ltd.  
miki@omst.co.il  
www.omst.co.il



## ISRAEL

Ancitech Ltd.  
info@ancitech.com  
www.ancitech.com



## ITALY

Murrelektronik S.r.l.  
info@murrelektronik.it  
www.murrelektronik.it



## JAPAN

K.MECS Co., Ltd.  
info@murrelektronik.jp  
www.murrelektronik.jp



## KENYA

Profa-Tech Ltd.  
info@profa-tech.com  
www.profa-tech.com



## LEBANON

Praucs  
fouad.riachy@praucs.com  
www.praucs.com



## MALAYSIA

Murr Asia-Pacific Pte. Ltd.  
sales@murrelektronik.sg  
www.murrelektronik.sg



## MALTA

AIM Enterprises Ltd.  
info@aim.com.mt  
www.aim.com.mt

# MURRELEKTRONIK REPRESENTED WORLDWIDE

**MEXICO**

Murrelektronik Inc.  
mluque@murrinc.com  
www.murrinc.com

**NETHERLANDS**

Murrelektronik B.V.  
sales@murrelektronik.nl  
www.murrelektronik.nl

**NEW ZEALAND**

Sick Pty. Ltd.  
sales@sick.co.nz  
www.sick.co.nz

**NORWAY**

Murrelektronik A.S.  
post@murrelektronik.no  
www.murrelektronik.no

**PAKISTAN**

Overseas Enterprises  
info@oe.com.pk  
rehan\_k@oe.com.pk  
www.oe.com.pk

**PERU**

Techpro SAC  
techpro.peru@techprocorp.net  
www.techprocorp.net

**POLAND**

Murrelektronik Sp. z o.o.  
info@murrelektronik.pl  
www.murrelektronik.pl

**PORTUGAL**

F.Fonseca S.A.  
ffonseca@ffonseca.com  
www.ffonseca.com

**ROMANIA**

Murrelektronik GmbH Austria  
info@murrelektronik.at  
www.murrelektronik.at

**RUSSIA**

Murrelektronik GmbH  
info@murrelektronik.com  
www.murrelektronik.ru

**SERBIA**

Murrelektronik GmbH Austria  
info@murrelektronik.at  
www.murrelektronik.at

**SINGAPORE**

Murr Asia-Pacific Pte. Ltd.  
sales@murrelektronik.sg  
www.murrelektronik.sg

**SLOVAKIA**

Murrelektronik Slovakia s.r.o.  
info@murrelektronik.sk  
www.murrelektronik.sk

**SLOVENIA**

Murrelektronik GmbH Austria  
info@murrelektronik.at  
www.murrelektronik.at

**SPAIN**

Murrelektronik Spain S.L.U.  
ventas@murrelektronik.es  
www.murrelektronik.es

**SOUTH AFRICA**

Rubicon Electrical  
and Automation  
eldred@rubiconsa.com  
www.rubiconsa.com

**SOUTH KOREA**

Murrelektronik Korea Ltd.  
sales@murrelektronik.kr  
www.murrelektronik.kr

**SRI LANKA**

Sim Lanka (Pvt) Ltd.  
info@simlanka.com  
www.simlanka.com

**SWEDEN**

Murrelektronik AB  
info@murrelektronik.se  
www.murrelektronik.se

**SWITZERLAND**

Murrelektronik AG  
info@murrelektronik.ch  
www.murrelektronik.ch

**TAIWAN**

Lintronix Co. Ltd.  
info@lintronix.com.tw  
www.lintronix.com.tw

**THAILAND**

Maxtech Control Co., Ltd.  
info@maxtechcontrol.co.th  
www.maxtechcontrol.co.th

**TURKEY**

Murr Elektronik San. ve Tic. Ltd. Sti  
info@murrelektronik.com.tr  
www.murrelektronik.com.tr

**UNITED ARAB EMIRATES**

King Power Electrical Accessories Trading  
kpower@eim.ae  
www.kingpowerelectrical.ae

**USA**

Murrelektronik Inc.  
2info@murrinc.com  
www.murrinc.com

**VIETNAM**

OMINA Industrial Automation J.S.C  
inquiry@omina.com.vn  
www.omina.com.vn



1

## ELECTRONICS IN THE CONTROL CABINET

# 1

## ELECTRONICS IN THE CONTROL CABINET

Transformers / Rectified Power Supplies		<b>1.1</b>
Power Supply Units		<b>1.2</b>
UPS-Systems / Buffer- / Redundancy Modules		<b>1.3</b>
Intelligent Power Distribution		<b>1.4</b>
Converters / Rectifiers		<b>1.5</b>
Control Cabinet Power Outlets	<i>An overview of this product range can be found in our online shop</i>	<b>1.6</b>
EMC Filters		<b>1.7</b>
EMC Suppressors		<b>1.8</b>
Relays / Safety Relays		<b>1.9</b>
Optocouplers / Semiconductors		<b>1.10</b>
Switches		<b>1.11</b>
Active Interface Technology	<i>An overview of this product range can be found in our online shop</i>	<b>1.12</b>
Passive Interface Technology	<i>An overview of this product range can be found in our online shop</i>	<b>1.13</b>
Eurocard Holders / Control Modules	<i>An overview of this product range can be found in our online shop</i>	<b>1.14</b>



# TRANSFORMERS / RECTIFIED POWER SUPPLIES

- Approvals for the global market
- Flexible and versatile
- Customized solutions

## MTS, MST, MET OR MTL – THE RIGHT TRANSFORMER FOR EVERY APPLICATION

Different situations require different voltages. Transformers have to be just as flexible as the application. Murrelektronik's range provides you with the flexibility you need!

No matter if it's an isolation transformer, control transformer, or safety transformer – we have the right solution for any application. Murrelektronik's transformers are reliable, safe and their approvals and voltage ranges make them ideal for worldwide use.

### BASIC FUNCTIONS

Rectified power supplies galvanically separate input and output. They convert mains voltage into Protected Extra Low Voltage. The electronic unit rectifies and smooths the voltage.

Rectified power supplies are designed for a frequency of 50/60 Hz. Their slow reaction prevents voltage spikes from being passed from the mains side to the output, which would interfere with peripheral devices.

They have fixing brackets with keyholes that ensure easy wall mounting. Models for DIN-rail mounting are available for applications up to 5 A.

### Transformers



#### MTS – Isolation class T 40/B

- Nominal power rating: 40...250 VA
- Input voltage: 230, 400 V AC or multi voltage ( $\pm 15$  V AC)
- Output voltage: 24 V AC or 230 V AC
- Ambient temperature: 40 °C

Page 1.1.1



#### MST – Isolation class T 40/B

- Nominal power rating: 320...1000 VA
- Input voltage: 230, 400 V AC or multi voltage
- Output voltage: 24 V AC or 230 V AC
- Ambient temperature: 40 °C

Page 1.1.4



#### MTL – Isolation class T 60/B

- Nominal power rating: 25...2500 VA
- Input voltage: 230/400 V AC  $\pm 15$  V AC
- Output voltage: 2 x 24 V AC or 2 x 115 V AC
- Ambient temperature: 60 °C

Page 1.1.7

## Single-phase, single/two-phase, smoothed (Rectified Power Supplies)



**MEN**

- Input voltage: 115/230 V AC and 230/400 V AC  
±15 V AC reconnectable
- Output voltage: 24 V DC SELV
- Output current: 1.0/2.5/5/7.5/10/15/20 A

*Page 1.1.8*



**MTPS**

- Input voltage: 230/400 V AC  
±15 V AC reconnectable
- Output voltage: 24 V DC SELV
- Output current: 0.5/1/2/4/6/10 A

*Page 1.1.12*

## Three-phase, smoothed (Rectified Power Supplies)



**MPL**

- Input voltage: 3 × 400 V AC ±5% reconnectable  
3 × 208...520 V AC
- Output voltage: 24 V DC SELV
- Output current: 5...60 A

*Page 1.1.13*

# TRANSFORMERS / RECTIFIED POWER SUPPLIES

1-/2-phase

– INPUT: 230/400 V AC

– Isolation class T 40/B

Approvals: 

**MTS**

OUTPUT: 230 V AC  
Screw terminals



**MTS**

OUTPUT: 230 V AC  
Spring clamp terminals

**MTS**

OUTPUT: 24 V AC  
Screw terminals

**MTS**

OUTPUT: 24 V AC  
Spring clamp terminals

## Circuit diagram

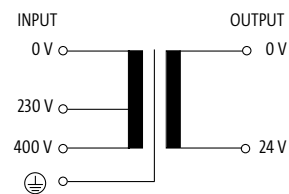
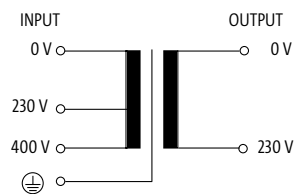

Order Data	HxWxD/kg	Art-No.	HxWxD/kg	Art-No.	HxWxD/kg	Art-No.	HxWxD/kg	Art-No.
40 VA	79x78x93/0.8	<b>86346</b>	79x78x93/0.8	<b>6686346</b>	79x78x93/0.8	<b>86340</b>	79x78x93/0.8	<b>6686340</b>
63 VA	79x78x93/1.2	<b>86347</b>	79x78x93/1.2	<b>6686347</b>	79x78x93/1.2	<b>86341</b>	79x78x93/1.2	<b>6686341</b>
100 VA	86x84x98/2.0 – GL	<b>86348</b>	86x84x98/2.0	<b>6686348</b>	86x84x98/2.0 – GL	<b>86342</b>	86x84x98/2.0	<b>6686342</b>
160 VA	101x96x106/2.7 – GL	<b>86349</b>	101x96x106/2.7	<b>6686349</b>	101x96x106/2.7 – GL	<b>86343</b>	101x96x106/2.7	<b>6686343</b>
250 VA	102x96x108/3.5 – GL	<b>86351</b>	102x96x108/3.5	<b>6686351</b>	102x96x108/3.5 – GL	<b>86345</b>	102x96x108/3.5	<b>6686345</b>

Input		
Input voltage	230/400 V AC	
Frequency	50...60 Hz	
Output		
Output voltage	230 V AC	24 V AC (SELV)
Output rating	40 VA	
General data		
Test isolation voltage	4 kV (prim./sec.)	
Standards	EN 61558-1, EN 61558-2-4, EN 62041 category 0	EN 61558-1, EN 61558-2-6, EN 62041 category 0
Mounting method	Long-hole mounting or DIN-rail mountable TH35 (EN 60715)	
Temperature range	-20...+40 °C (storage temperature -40...+80 °C)	
Dimension drawing		

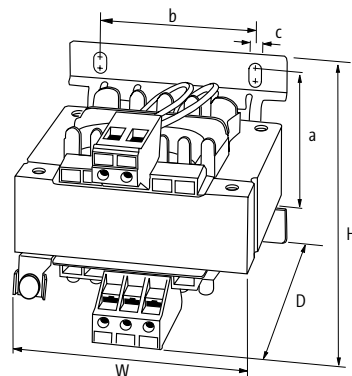

Notes	
	GL-Approval from 100 VA and with screw terminals.

# TRANSFORMERS / RECTIFIED POWER SUPPLIES

1-/2-phase

– INPUT: 230/400 ±15 V AC

– Isolation class T 40/B

Approvals: 

**MTS+**

OUTPUT: 230 V AC  
Screw terminals



**MTS+**

OUTPUT: 230 V AC  
Spring clamp terminals



**MTS+**

OUTPUT: 24 V AC  
Screw terminals



**MTS+**

OUTPUT: 24 V AC  
Spring clamp terminals



Circuit diagram

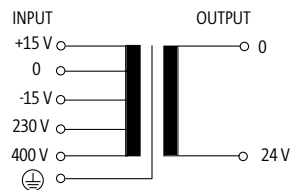
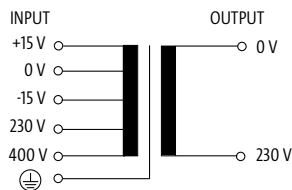

Order Data	HxWxD/kg	Art-No.	HxWxD/kg	Art-No.	HxWxD/kg	Art-No.	HxWxD/kg	Art-No.
40 VA	79×78×93/0.8	<b>86366</b>	79×78×93/0.8	<b>6686366</b>	79×78×93/0.8	<b>86360</b>	79×78×93/0.8	<b>6686360</b>
63 VA	79×78×93/1.2	<b>86367</b>	79×78×93/1.2	<b>6686367</b>	79×78×93/1.2	<b>86361</b>	79×78×93/1.2	<b>6686361</b>
100 VA	86×84×98/2.0 – GL	<b>86368</b>	86×84×98/2.0	<b>6686368</b>	86×84×98/2.0 – GL	<b>86362</b>	86×84×98/2.0	<b>6686362</b>
160 VA	101×96×106/2.7 – GL	<b>86369</b>	101×96×106/2.7	<b>6686369</b>	101×96×106/2.7 – GL	<b>86363</b>	101×96×106/2.7	<b>6686363</b>
250 VA	102×96×108/3.5 – GL	<b>86371</b>	102×96×108/3.5	<b>6686371</b>	102×96×108/3.5 – GL	<b>86365</b>	102×96×108/3.5	<b>6686365</b>

**Input**

Input voltage 230/400 ±15 V AC

Frequency 50...60 Hz

**Output**

Output voltage 230 V AC

24 V AC (SELV)

Output rating 40 VA

**General data**

Standards EN 61558-1, EN 61558-2-4, EN 62041 category 0

EN 61558-1, EN 61558-2-6, EN 62041 category 0

Test isolation voltage 4 kV (prim./sec.)

Mounting method Long-hole mounting or DIN-rail mountable TH35 (EN 60715)

Temperature range -20...+40 °C (storage temperature -40...+80 °C)

**Dimension drawing**

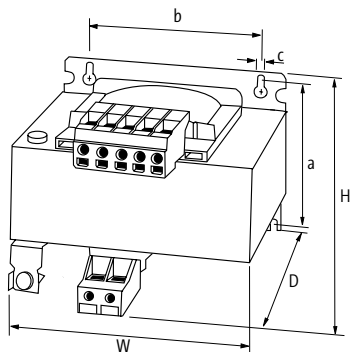

**Notes**

GL-Approval from 100 VA and with screw terminals.

# TRANSFORMERS / RECTIFIED POWER SUPPLIES

1-2-phase

– INPUT: 208...550 V AC

– Isolation class T 40/B

Approvals: 

## MTS Multi

OUTPUT: 1 × 230, 1 × 115, 2 × 115 V AC

Screw terminals



### Circuit diagram

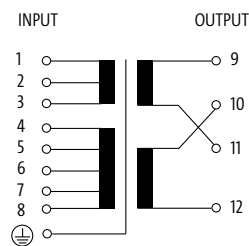

Order Data	H×W×D/kg	Art-No.
25 VA	90×78×102/0.7	86140
40 VA	88×78×93/1.1	86141
63 VA	97×78×93/1.4	86142
100 VA	105×84×98/2.0 – GL	86143
160 VA	101×96×106/2.7 – GL	86144

Input	
Input voltage	208, 230, 380, 400, 420, 440, 460, 480, 500, 525, 550 V AC
Frequency	50...60 Hz
Output	
Output voltage	1 × 230, 1 × 115, 2 × 115 V AC
Output rating	25 VA
General data	
Standards	EN 61558-1, EN 61558-2-4, EN 62041 category 0
Test isolation voltage	4 kV (prim./sec.)
Mounting method	Long-hole mounting or DIN-rail mountable TH35 (EN 60715)
Temperature range	-20...+40 °C (storage temperature -20...+80 °C)

### Dimension drawing

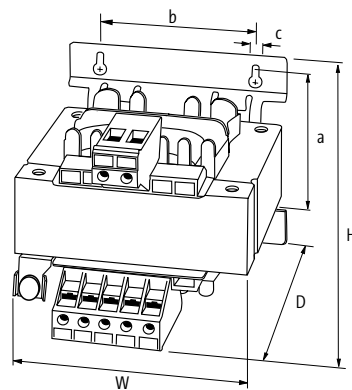

### Notes

GL-Approval from 100 VA and with screw terminals.

# TRANSFORMERS / RECTIFIED POWER SUPPLIES

1-/2-phase  
 – INPUT: 230/400 V AC  
 – Isolation class T 40/B

Approvals: 

**MST**  
 OUTPUT: 230 V AC  
 Screw terminals



**MST**  
 OUTPUT: 230 V AC  
 Spring clamp terminals

**MST**  
 OUTPUT: 24 V AC  
 Screw terminals

**MST**  
 OUTPUT: 24 V AC  
 Spring clamp terminals

## Circuit diagram

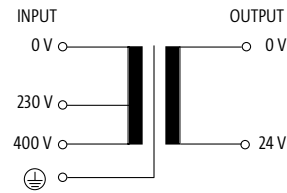
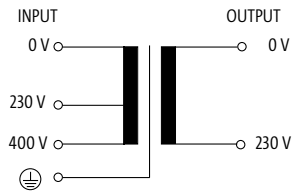

Order Data	HxWxD/kg	Art-No.	HxWxD/kg	Art-No.	HxWxD/kg	Art-No.	HxWxD/kg	Art-No.
320 VA	92x120x122/4.2 – GL	<b>86306</b>	92x120x122/4.2	<b>6686306</b>	92x120x122/4.2 – GL	<b>86326</b>	92x120x122/4.2	<b>6686326</b>
400 VA	104x120x123/5.2 – GL	<b>86307</b>	104x120x123/5.2	<b>6686307</b>	104x120x123/5.2 – GL	<b>86327</b>	104x120x123/5.2	<b>6686327</b>
500 VA	108x135x134/6.5 – GL	<b>86308</b>	108x135x134/6.5	<b>6686308</b>	108x135x134/6.5 – GL	<b>86328</b>		
630 VA	113x150x145/7.7 – GL	<b>86309</b>	113x150x145/7.7	<b>6686309</b>	113x150x145/7.7 – GL	<b>86329</b>		
800 VA	129x150x145/10.1 – GL	<b>86310</b>	129x150x145/10.1	<b>6686310</b>	136x150x149/10.1 – GL	<b>86330</b>		
1 000 VA	128x174x160/12.3 – GL	<b>86311</b>	128x174x160/12.3	<b>6686311</b>	133x174x165/12.3 – GL	<b>86331</b>		

## Input

Input voltage 230/400 V AC  
 Frequency 50...60 Hz

## Output

Output voltage 230 V AC 24 V AC (SELV)  
 Output rating 320 VA

## General data

Standards EN 61558-1, EN 61558-2-4, EN 62041 category 0 EN 61558-1, EN 61558-2-6, EN 62041 category 0  
 Test isolation voltage 4 kV (prim./sec.)  
 Mounting method Key-hole mounting  
 Temperature range -20...+40 °C (storage temperature -40...+80 °C)

## Dimension drawing

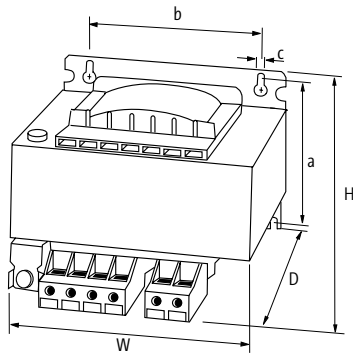

## Notes

# TRANSFORMERS / RECTIFIED POWER SUPPLIES

1-/2-phase

– INPUT: 230/400 ±15 V AC

– Isolation class T 40/B

Approvals:  

**MST+**

OUTPUT: 24 V AC, 48 V AC  
Screw terminals



**MST+**

OUTPUT: 115 V AC, 230 V AC  
Screw terminals

**Circuit diagram**

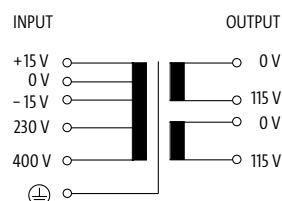
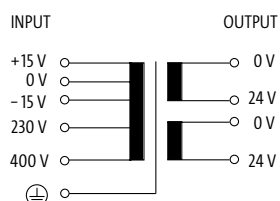

Order Data	H×W×D/kg	Art-No.	H×W×D/kg	Art-No.
630 VA	121×150×165/8.0	<b>86463</b>	113×150×146/8.2	<b>86483</b>
1 000 VA	156×150×197/13.5	<b>86464</b>	156×150×146/13.5	<b>86484</b>
1 600 VA	168×174×222/19.5	<b>86465</b>	168×174×163/19.5	<b>86485</b>
2 500 VA	182×192×242/27.0	<b>86466</b>	182×192×196/27.0	<b>86486</b>

**Input**

Input voltage	230/400 ±15 V AC
Frequency	50...60 Hz

**Output**

Output voltage	1 × 24, 1 × 48, 2 × 24 V AC	1 × 230, 1 × 115, 2 × 115 V AC
Output rating	630 VA	

**General data**

Standards	EN 61558-1, EN 61558-2-4, EN 62041 category 0
Test isolation voltage	5.8 kV (prim./sec.)
Mounting method	Key-hole mounting
Temperature range	-20...+40 °C, no condensation

**Dimension drawing**

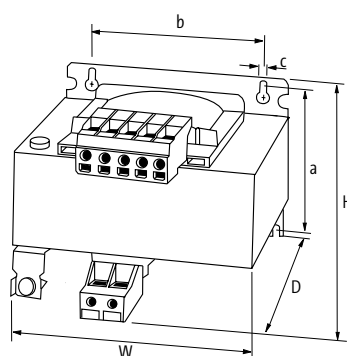

**Notes**

# TRANSFORMERS / RECTIFIED POWER SUPPLIES

1-/2-phase

– INPUT: 208...550 V AC

– Isolation class T 40/B

Approvals:  

## MST Multi

OUTPUT: 1 × 230, 1 × 115, 2 × 115 V AC  
Screw terminals



### Circuit diagram

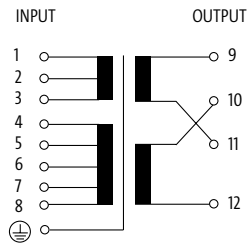

Order Data	H×W×D/kg	Art-No.
250 VA	104×120×122/4.0	86145
320 VA	115×135×132/5.8	86146
400 VA	115×135×132/6.2	86147
500 VA	138×135×135/5.8	86148
800 VA	156×150×150/7	86150
1 000 VA	128×174×160/12.3	86151
1 600 VA	168×174×163/7	86152
2 000 VA	185×192×185/10	86153
2 500 VA	200×195×217/10	86154
3 000 VA	250×197×193/29.5	86155
5 000 VA	248×197×250/9	86157

### Input

Input voltage 208, 230, 380, 400, 420, 440, 460, 480, 500, 525, 550 V AC  
Frequency 50...60 Hz

### Output

Output voltage 1 × 230, 1 × 115, 2 × 115 V AC  
Output rating 250 VA

### General data

Standards EN 61558-1, EN 61558-2-4, EN 62041 category 0  
Test isolation voltage 4 kV (prim./sec.)  
Mounting method Key-hole mounting  
Temperature range -20...+40 °C (storage temperature -20...+80 °C)

### Dimension drawing

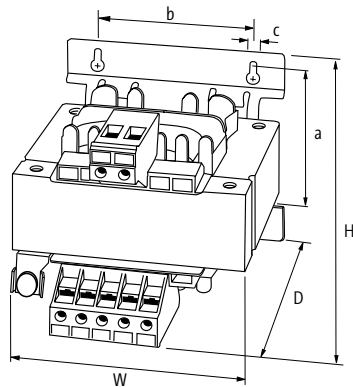

### Notes



# TRANSFORMERS / RECTIFIED POWER SUPPLIES

1-/2-phase

– INPUT: 230/400 ±15 V AC

– Isolation class T 60/B

Approvals:  

**MTL**

OUTPUT: 24 V AC, 48 V AC  
Screw terminals



**MTL**

OUTPUT: 115 V AC, 230 V AC  
Screw terminals

**Circuit diagram**

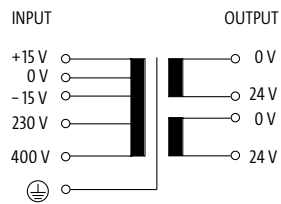

Order Data	H×W×D/kg	Art-No.	H×W×D/kg	Art-No.
25 VA	108×87×98/1.1	<b>86450</b>	108×87×98/1.1	<b>86470</b>
40 VA	108×87×104/1.4	<b>86451</b>	108×87×104/1.4	<b>86471</b>
63 VA	108×87×116/2.0	<b>86452</b>	108×87×116/2.0	<b>86472</b>
100 VA	108×87×139/2.9	<b>86453</b>	108×87×139/2.9	<b>86473</b>
160 VA	153×123×128/4.4	<b>86454</b>	153×123×128/4.4	<b>86474</b>
250 VA	153×123×142/5.7	<b>86455</b>	153×123×142/5.7	<b>86475</b>
320 VA	153×123×160/7.2	<b>86456</b>	153×123×160/7.2	<b>86476</b>

**Technical Data**

LED display LED (green) for input voltage

**Input**

Input voltage 230/400 ±15 V AC

Frequency 50...60 Hz

**Output**

Output voltage 1 × 24, 1 × 48, 2 × 24 V AC

1 × 230, 1 × 115, 2 × 115 V AC

Output rating 25 VA

**General data**

Test isolation voltage 5.1 kV (prim./sec.) 4 kV (prim./sec.)

Standards EN 61558-2-4, EN 61558-2-6, EN 62041 category 0 EN 61558-1, EN 61558-2-4, EN 62041 category 0

Mounting method DIN-rail mountable TH35-15 (EN 60715) or for key-hole mounting

Temperature range -20...+60 °C, no condensation

**Dimension drawing**

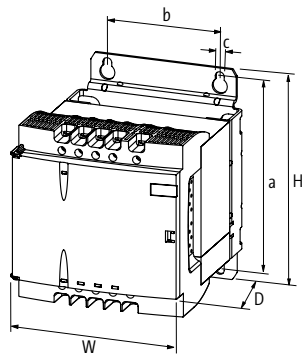

**Notes**

# TRANSFORMERS / RECTIFIED POWER SUPPLIES

Single-phase

– OUTPUT: 24 V DC (SELV)

Approvals: 

**MEN**

INPUT: 115/230 V AC



**MEN**

INPUT: 115/230 V AC  
with MES DIN-rail adapter

## Circuit diagram

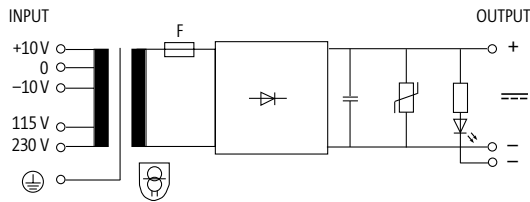

Order Data	HxWxD/kg	Art-No.	HxWxD/kg	Art-No.
24 V DC/1 A	64x78x120/1.3	<b>85360</b>	64x78x120/1.3	<b>8985360</b>
24 V DC/2.5 A	83x84x124/2.1	<b>85361</b>	83x84x124/2.1	<b>8985361</b>
24 V DC/5 A	95x96x136/3.0	<b>85362</b>	95x96x136/3.0	<b>8985362</b>
24 V DC/7.5 A	103x105x151/5.6	<b>85363</b>		

## Input

Input voltage	115/230 V AC $\pm 10$ V AC
Frequency	50...60 Hz

## Output

Output voltage	24 V DC (SELV)
Ripple	max. 5 %rms
Output filter	LED, VDR and smoothing capacitor

## General data

Standards	EN 61558-2-6, EN 62041 category I, EN 55011 B, EN 61000-3-2	
Mounting method	Key-hole mounting	DIN-rail mountable TH35-15 (EN 60715) or for key-hole mounting
Temperature range	-20...+60 °C, no condensation	

## Dimension drawing

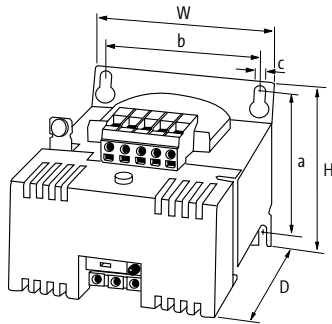

## Notes

# TRANSFORMERS / RECTIFIED POWER SUPPLIES

Single-phase

– OUTPUT: 24 V DC (SELV)

**MEN**

INPUT: 115/230 V AC



Approvals:

## Circuit diagram

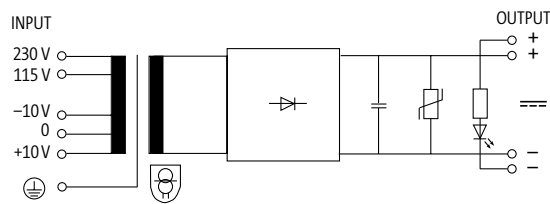

Order Data	H×W×D/kg	Art-No.
24 V DC/10 A	113×120×160/6.0	85364
24 V DC/15 A	139×135×182/8.2	85355
24 V DC/20 A	127×174×214/12.8	85356
<b>Input</b>		
Input voltage	115/230 V AC ±10 V AC	
Frequency	50...60 Hz	
<b>Output</b>		
Output voltage	24 V DC (SELV)	
Ripple	max. 5 %rms	
Output filter	LED, VDR and smoothing capacitor	
<b>General data</b>		
Standards	EN 61558-2-6, EN 62041 category I, EN 55011 B, EN 61000-3-2	
Mounting method	Key-hole mounting	
Temperature range	-20...+60 °C, no condensation	
<b>Dimension drawing</b>		

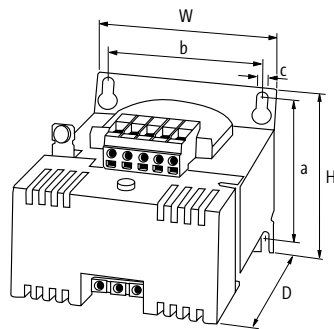

## Notes

# TRANSFORMERS / RECTIFIED POWER SUPPLIES

1-/2-phase

– OUTPUT: 24 V DC (SELV)

Approvals: 

**MEN**

INPUT: 230/400 V AC



**MEN**

INPUT: 230/400 V AC  
with MES DIN-rail adapter

## Circuit diagram

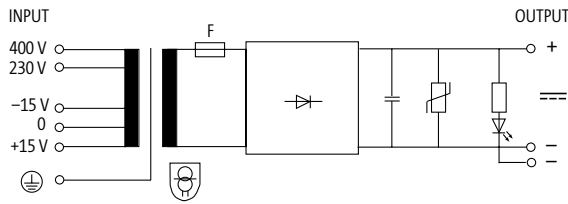

Order Data	HxWxD/kg	Art-No.	HxWxD/kg	Art-No.
24 V DC/1 A	64x78x120/1.3	85349	64x78x120/1.3	8985349
24 V DC/2.5 A	83x84x124/2.1	85350	83x84x124/2.1	8985350
24 V DC/5 A	95x96x136/3.0	85351	95x96x136/3.0	8985351
24 V DC/7.5 A	103x105x151/5.6	85357		

## Input

Input voltage	230/400 ±15 V AC
Frequency	50...60 Hz

## Output

Output voltage	24 V DC (SELV)
Ripple	max. 5 %rms
Output filter	LED, VDR and smoothing capacitor

## General data

Standards	EN 61558-2-6, EN 62041 category I, EN 55011 B, EN 61000-3-2	
Mounting method	Key-hole mounting	DIN-rail mountable TH35-15 (EN 60715) or for key-hole mounting
Temperature range	-20...+60 °C, no condensation	

## Dimension drawing

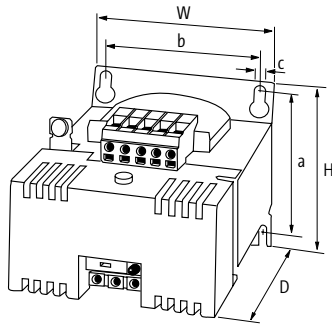

## Notes

# TRANSFORMERS / RECTIFIED POWER SUPPLIES

1-/2-phase

– OUTPUT: 24 V DC (SELV)

**MEN**

INPUT: 230/400 V AC



Approvals:

## Circuit diagram

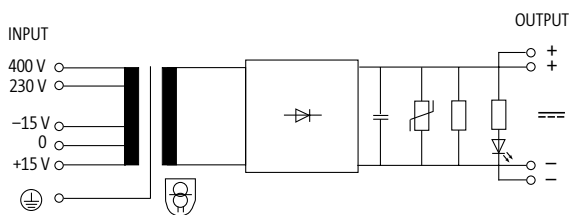

Order Data	H×W×D/kg	Art-No.
24 V DC/10 A	113×120×160/6.0	85352
24 V DC/15 A	139×135×182/8.2	85353
24 V DC/20 A	127×174×214/12.8	85354
<b>Input</b>		
Input voltage	230/400 ±15 V AC	
Frequency	50...60 Hz	
<b>Output</b>		
Output voltage	24 V DC (SELV)	
Ripple	max. 5 %rms	
Output filter	LED, VDR and smoothing capacitor	
<b>General data</b>		
Standards	EN 61558-2-6, EN 62041 category I, EN 55011 B, EN 61000-3-2	
Mounting method	Key-hole mounting	
Temperature range	-20...+60 °C, no condensation	
<b>Dimension drawing</b>		

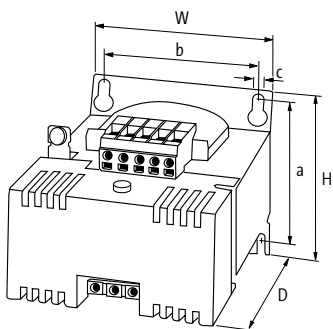

## Notes

# TRANSFORMERS / RECTIFIED POWER SUPPLIES

1-/2-phase

– OUTPUT: 24 V DC (SELV)

Approvals: 

## MTPS

INPUT: 230/400 V AC



### Circuit diagram

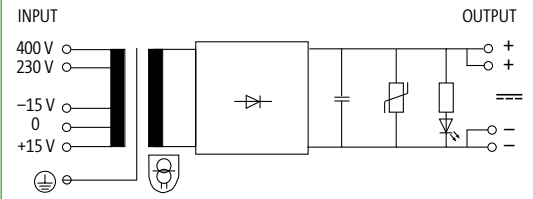
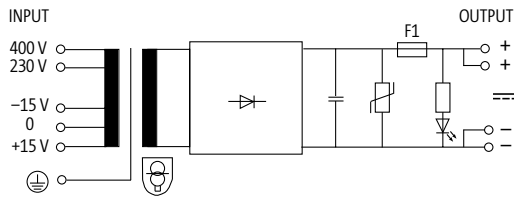

Order Data	HxWxD/kg	Art-No.	HxWxD/kg	Art-No.
24 V DC/0.5 A	108x87x124/1.3	85400		
24 V DC/1 A	108x87x124/1.3	85401		
24 V DC/2 A	108x87x142/2.0	85402		
24 V DC/4 A	108x87x165/2.9	85403		
24 V DC/6 A	153x123x153/4.9	85404		
24 V DC/10 A			153x123x185/7.7	85405

Input	
Input voltage	230/400 ±15 V AC
Frequency	50...60 Hz
LED display	LED (green) for input voltage
Output	
Output voltage	24 V DC (SELV)
Ripple	max. 5 %rms
Output filter	LED, VDR and smoothing capacitor
General data	
Standards	EN 61558-2-6, EN 62041 category I, EN 55011 B, EN 61000-3-2
Temperature range	-20...+60 °C, no condensation
Mounting method	DIN-rail mountable TH35-15 (EN 60715) or for key-hole mounting

### Dimension drawing

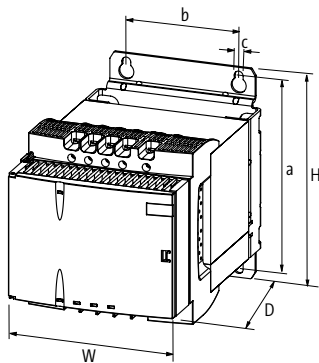

### Notes

3-phase

– OUTPUT: 24 V DC (SELV)

Approvals: UL Listed

### MPL

INPUT: 3 × 400 V AC, ±5% reconnectable



### MPL Multi

INPUT: 3 × 208...520 V AC



#### Circuit diagram

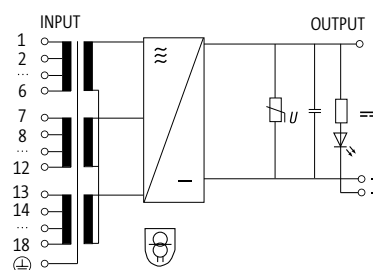
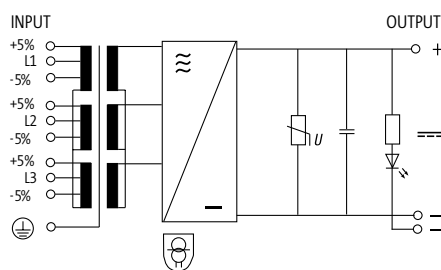

Order Data	HxWxD/kg	Art-No.	HxWxD/kg	Art-No.
24 V DC/5 A	125x73x153/2.9 – cURus	85921		
24 V DC/7.5 A	185x78x188/4.4 – cURus	85923		
24 V DC/10 A	185x78x188/4.5 – cURus	85925	185x93x188/6.6	85953
24 V DC/15 A	220x82x208/8.2 – cURus	85927	220x82x208/7.5	85954
24 V DC/20 A	220x103x213/10.5 – cURus	85929		
24 V DC/25 A	220x103x213/11.0 – cURus	85931	220x103x213/11.1 – cURus	85955
24 V DC/30 A	240x107x250/13.5 – cURus	85933		
24 V DC/40 A	280x124x313/17.8 – cURus	85935	280x124x313/17.9 – cURus	85956
24 V DC/50 A	280x134x313/20.9 – cURus	85937	280x134x313/20.9 – cURus	85957
24 V DC/60 A	280x154x313/26.1 – cURus	85939		

Input		
Input voltage	3 × 400 V AC ±5%	3 × 208...520 V AC
Frequency	50...60 Hz	

Output	
Output voltage	24 V DC (SELV)
Ripple	max. 2%rms
Output filter	LED, VDR and smoothing capacitor

General data	
Standards	EN 61558-2-6, EN 62041 category I, EN 55011 B, EN 61000-3-2
Mounting method	Key-hole mounting
Temperature range	-20...+55 °C, for any mounting position at vertical wall, no condensation

#### Dimension drawing

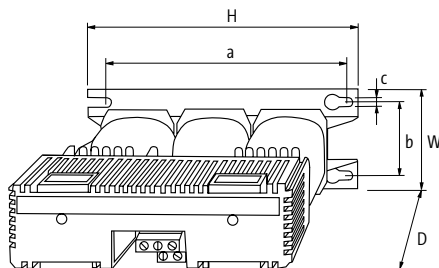

#### Notes



# SWITCHING POWER SUPPLIES EMPARRO® – SIMPLY THE BEST

- Efficiency up to 96%
- 150% Power Boost for 4 seconds

## EMPARRO® – THE SWITCHING POWER SUPPLY WITH MAXIMUM EFFICIENCY

- Efficiency up to 96%
- 150% Power Boost for four seconds
- Metal housing with optimum EMC characteristics
- Derating only at +60 °C
- Reduced width
- Long bridging time in case of a power failure
- More than 30 variants – the solution for many applications

### Competitive comparison of Emparro®

The comparison based on the same input current shows: Emparro (on the left) releases



significantly less heat than conventional switching power supplies. The devices remain cooler

and protect the neighboring components. This results in a longer service life.

## Switching power supplies



### Emparro®

- Single-phase, two-phase, three-phase
- Spring clamp terminal
- AS-Interface

Page 1.2.1



### Emparro® HD

- Single-phase
- Robust design

Page 1.2.4



### Emparro®67

- Single-phase
- IP67
- IO-Link
- Preventive diagnostics



Page 1.2.8



### Evolution/Evolution+

- Two-phase, three-phase
- Extended temperature range from -25...+70 °C
- Approvals for worldwide use

Page 1.2.10



### ECO-Rail-2

- Single-phase
- Useful and flexible

Page 1.2.16



### PICCO

- Single-phase
- 16 variants
- 12 V or 24 V outputs
- 10 W, 30 W, 60 W or 100 W

Page 1.2.18



# POWER SUPPLY UNITS

## Single-phase

– Short-circuit and overload protected

– Alarm contact

Approvals:

### Emparro®

OUTPUT: 24...28 V DC  
Current: 5 A



### Emparro®

OUTPUT: 24...28 V DC  
Current: 10 A



### Emparro®

OUTPUT: 24...28 V DC  
Current: 20 A



Order Data	Art-No.	Art-No.	Art-No.
24 V DC/5 A (for DIN-Rail)	85440		
24 V DC/5 A (for screwing)	85702		
24 V DC/10 A (for DIN-Rail)		85441	
24 V DC/10 A (for screwing)		85703	
24 V DC/20 A (for DIN-Rail)			85442
24 V DC/20 A (for screwing)			85704
<b>Input</b>			
Input voltage	85...265 V AC/90...250 V DC		90...265 V AC/90...250 V DC
Input current	1.3 A (100 V AC); 0.61 A (240 V AC)	2.6 A (100 V AC); 1.1 A (240 V AC)	5.2 A (100 V AC); 2.2 A (240 V AC)
Inrush current after 1 ms	max. 5.5 A (230 V AC)	max. 13 A	max. 23 A (230 V AC)
Power factor	0.87 (230 V AC)	0.95 (230 V AC)	0.96 (230 V AC)
Frequency	50...60 Hz		
Input fuse (internal)	6.3 A (T)		10 A (T)
<b>Output</b>			
Output voltage	24 V DC (SELV), ±1%; 24...28 V adjustable		
Power Boost	I <sub>out</sub> N × 150% (min. 4 s)		
Output current	5 A	10 A	20 A
Mains failure bridging time	min. 30 ms (100 V AC); 5 A (24 V DC)	min. 30 ms (100 V AC); 10 A (24 V DC)	min. 30 ms (100 V AC); 20 A (24 V DC)
Ripple	max. 50 mVrms		
Spikes	max. 200 mV p-p		
Unit protection	Short-circuit and overload protected		
LED display	LED (green): OK; LED (red): overload, overheating or short-circuit		
Parallel usage/serial usage	max. 5 units/max. 2 units		
<b>General data</b>			
Standards	EN 60950-1, EN 61204-3, EN 55011 B, EN 61000-3-2, SEMI F47		
Relative humidity	5...95%, no condensation		
Protection	IP20		
Efficiency	92.7% (110 V AC); 94.5% (230 V AC)	92.8% (110 V AC); 94.3% (230 V AC)	91.7% (110 V AC); 94.1% (230 V AC)
Connection	Push-In spring clamp terminals		
Temperature range	-40...+60 °C, ...+70 °C derating (storage temperature -40...+80 °C)		
<b>Dimension drawing</b>			
<b>Notes</b>			

# POWER SUPPLY UNITS

## Single-phase

– Short-circuit and overload protected

– Alarm contact

Approvals:  

**Emparro®**  
OUTPUT: 48...56 V DC  
Current: 2.5 A



**Emparro®**  
OUTPUT: 48...56 V DC  
Current: 5 A



**Emparro®**  
OUTPUT: 48...56 V DC  
Current: 10 A



Order Data	Art-No.	Art-No.	Art-No.
48 V DC/2.5 A (for DIN-Rail)	<b>85437</b>		
48 V DC/2.5 A (for screwing)	<b>85722</b>		
48 V DC/5 A (for DIN-Rail)		<b>85438</b>	
48 V DC/5 A (for screwing)		<b>85723</b>	
48 V DC/10 A (for DIN-Rail)			<b>85439</b>
48 V DC/10 A (for screwing)			<b>85724</b>

Input			
Input voltage	85...265 V AC/90...250 V DC		
Input current	1.2 A (100 V AC); 0.6 A (240 V AC)	2.6 A (100 V AC); 1.1 A (240 V AC)	5.1 A (100 V AC); 2.4 A (240 V AC)
Inrush current after 1 ms	max. 3.5 A (230 V AC)	max. 5.5 A (230 V AC)	max. 11 A (230 V AC)
Power factor	0.87 (230 V AC)	0.95 (230 V AC)	0.94 (230 V AC)
Frequency	50..60 Hz		
Input fuse (internal)	6.3 A (T)		10 A (T)
Output			
Output voltage	48 V DC (SELV), ±1%; 48...56 V adjustable		
Power Boost	I <sub>out</sub> N × 150% (min. 4 s)		
Output current	2.5 A	5 A	10 A
Mains failure bridging time	min. 30 ms (100 V AC); 2.5 A (48 V DC)	min. 30 ms (100 V AC); 5 A (48 V DC)	min. 30 ms (100 V AC); 10 A (48 V DC)
Ripple	max. 50 mVrms		
Spikes	max. 200 mV p-p		
Unit protection	Short-circuit and overload protected		
LED display	LED (green): OK; LED (red): overload, overheating or short-circuit		
Parallel usage/serial usage	max. 5 units/max. 2 units		
General data			
Standards	EN 60950-1, EN 61204-3, EN 55011 B, EN 61000-3-2, SEMI F47		
Relative humidity	5...95%, no condensation		
Protection	IP20		
Efficiency	92.8% (110 V AC); 94.6% (230 V AC)	93.7% (110 V AC); 95.1% (230 V AC)	95%
Connection	Push-In spring clamp terminals		
Temperature range	-40...+60 °C, ...+70 °C derating (storage temperature -40...+80 °C)		

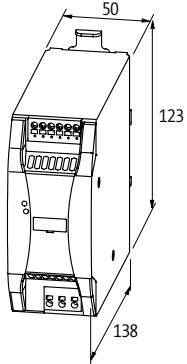
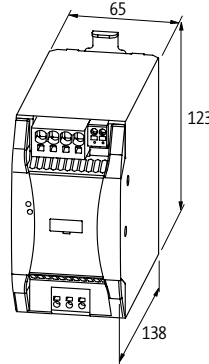
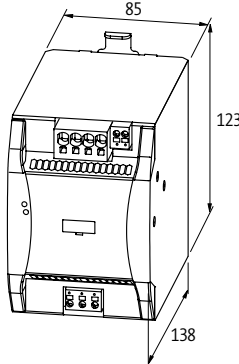
Dimension drawing			
			

Notes			

## POWER SUPPLY UNITS

### Single-phase

– Short-circuit and overload protected

– Alarm contact

Approvals:  

### Emparro®

OUTPUT: 12...15 V DC  
Current: 10 A



Order Data	Art-No.
12 V DC/10 A (for DIN-Rail)	85434
12 V DC/10 A (for screwing)	85712
Input	
Input voltage	85...265 V AC/90...250 V DC
Input current	1.2 A (100 V AC); 0.6 A (230 V AC)
Inrush current after 1 ms	max. 10 A (230 V AC)
Power factor	0.88 (230 V AC)
Frequency	50...60 Hz
Input fuse (internal)	6.3 A (T)
Output	
Output voltage	12 V DC (SELV), ±1%; 12...15 V adjustable
Power Boost	I <sub>out</sub> N × 150% (min. 4 s)
Output current	10 A
Mains failure bridging time	min. 30 ms (100 V AC); 10 A (12 V DC)
Ripple	max. 50 mVrms
Spikes	max. 200 mV p-p
Unit protection	Short-circuit and overload protected
LED display	LED (green): OK; LED (red): overload, overheating or short-circuit
Parallel usage/serial usage	max. 5 units/max. 2 units
General data	
Standards	EN 60950-1, EN 61204-3, EN 55011 B, EN 61000-3-2, SEMI F47
Relative humidity	5...95%, no condensation
Protection	IP20
Efficiency	91.4% (110 V AC); 93.2% (230 V AC)
Connection	Push-In spring clamp terminals
Temperature range	-40...+60 °C, ...+70 °C derating (storage temperature -40...+80 °C)
Dimension drawing	

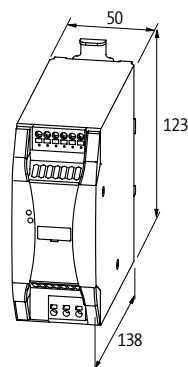

Notes

## POWER SUPPLY UNITS

### Single-phase

– Short-circuit and overload protected

– IP20

– rugged design

### Emparro® HD

OUTPUT: 24...28 V DC

Current: 10 A



Order Data	Art-No.
24 V DC/10 A	85449

Input	
Input voltage	90...265 V AC/90...370 V DC
Input current	1.1 A (240 V AC)
Inrush current after 1 ms	max. 7 A (240 V AC)
Power factor	0.91 (230 V AC)
Frequency	50...60 Hz
Input fuse (internal)	6.3 A (T)

Output	
Output voltage	24 V DC (SELV), $\pm 1\%$ ; 24...28 V adjustable
Power Boost	15 A (min. 5 s)
Output current	10 A
Mains failure bridging time	min. 35 ms (100 V AC); 10 A (24 V DC)

Ripple	max. 30 mVrms
Spikes	max. 300 mV p-p
Unit protection	Short-circuit and overload protected
LED display	LED (green): OK; LED (red): overload, overheating or short-circuit
Parallel usage/serial usage	max. 3 units/max. 2 units

General data	
Standards	EN 60950-1, EN 61204-3, EN 55022 B, EN 61000-3-2
Relative humidity	5...95%, no condensation
Protection	IP20
Efficiency	93.5% (115 V AC); 94.2% (230 V AC)
MTBF	1 000 000 h
Connection	Spring clamp terminals
Mounting method	screw fixing
Temperature range	-40...+50 °C, ...+80 °C derating (storage temperature -40...+85 °C)

### Dimension drawing

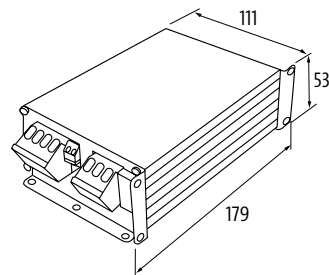

### Notes

# POWER SUPPLY UNITS

2-/3-phase

– Short-circuit and overload protected

– Alarm contact



## Emparro®

OUTPUT: 24...28 V DC  
Current: 5 A



## Emparro®

OUTPUT: 24...28 V DC  
Current: 10 A



Order Data	Art-No.	Art-No.
24 V DC/5 A (for DIN-Rail)	85690	
24 V DC/5 A (for screwing)	85695	
24 V DC/5 A (varnished board)	87690	
24 V DC/10 A (for DIN-Rail)		85691
24 V DC/10 A (for screwing)		85696
24 V DC/10 A (varnished board)		87691

Input		
Input voltage	3 × 324...572 V AC/450...745 V DC	
Input current	0.45 A (3 × 360 V AC); 0.3 A (3 × 500 V AC)	0.75 A (3 × 360 V AC); 0.55 A (3 × 500 V AC)
Inrush current after 1 ms	max. 9.5 A (3 × 500 V AC)	max. 9.0 A (3 × 500 V AC)
Power factor	0.61 (3 × 400 V AC)	0.66 (3 × 500 V AC)
Frequency	50...60 Hz	
Input fuse (internal)	3 × 6.3 A (T)	
Output		
Output voltage	24 V DC (SELV), ±1%; 24...28 V adjustable	
Power Boost	I <sub>out</sub> N × 150% (min. 5 s)	
Output current	3.7 A (70 °C); 5.0 A (60 °C); 6.0 A (45 °C)	12 A (45 °C); 10 A (60 °C); 7 A (70 °C)
Mains failure bridging time	min. 25 ms (3 × 360 V AC); 5 A (24 V DC)	min. 45 ms (3 × 500 V AC); 10 A (24 V DC)
Ripple	max. 20 mVrms	
Spikes	max. 50 mV p-p	
Unit protection	Short-circuit and overload protected, permanently by 20% (to 45 °C)	
LED display	LED (green): OK; LED (red): overload, overheating or short-circuit	
Parallel usage/serial usage	max. 3 units	
General data		
Standards	EN 60950-1, EN 61204-3, EN 55011 B, EN 61000-3-2, SEMI F47	
Relative humidity	5...95%, no condensation	
Protection	IP20	
Efficiency	92.5% (3 × 400 V AC); 91.8% (3 × 480 V AC)	93.7% (3 × 400 V AC); 93.2% (3 × 480 V AC)
Connection	Push-In spring clamp terminals	
Temperature range	-40...+70 °C, ...+70 °C derating (storage temperature -40...+85 °C)	

Dimension drawing	

Notes

# POWER SUPPLY UNITS

2-/3-phase

– Short-circuit and overload protected

– Alarm contact

Approvals:   

**Emparro®**

OUTPUT: 24...28 V DC  
Current: 20 A



**Emparro®**

OUTPUT: 24...28 V DC  
Current: 40 A



Order Data	Art-No.	Art-No.
24 V DC/20 A (for DIN-Rail)	<b>85692</b>	
24 V DC/20 A (for screwing)	<b>85697</b>	
24 V DC/20 A (varnished board)	<b>87692</b>	
24 V DC/40 A (for DIN-Rail)		<b>85693</b>
24 V DC/40 A (for screwing)		<b>85698</b>
24 V DC/40 A (varnished board)		<b>87693</b>

Input		
Input voltage	3 × 324...572 V AC/450...745 V DC	3 × 324...572 V AC/480...745 V DC
Input current	1.3 A (3 × 360 V AC); 1.0 A (3 × 500 V AC)	2.3 A (3 × 360 V AC); 1.6 A (3 × 500 V AC)
Inrush current after 1 ms	max. 13 A (3 × 500 V AC)	max. 14 A (3 × 500 V AC)
Power factor	0.65 (3 × 500 V AC)	0.88 (3 × 500 V AC)
Frequency	50...60 Hz	
Input fuse (internal)	3 × 6.3 A (T)	
Output		
Output voltage	24 V DC (SELV), ±1%; 24...28 V adjustable	
Power Boost	out N × 150% (min. 5 s)	
Output current	15 A (70 °C); 20 A (60 °C); 24 A (45 °C)	30 A (70 °C); 40 A (60 °C); 48 A (45 °C)
Mains failure bridging time	min. 40 ms (3 × 500 V AC)	

Ripple	max. 20 mVrms	
Spikes	max. 90 mV p-p	
Unit protection	Short-circuit and overload protected, permanently by 20% (to 45 °C)	
LED display	LED (green): OK; LED (red): overload, overheating or short-circuit	
Parallel usage/serial usage	max. 3 units	

General data		
Standards	EN 60950-1, EN 61204-3, EN 55011 B, EN 61000-3-2, SEMI F47	
Relative humidity	5...95%, no condensation	
Protection	IP20	
Efficiency	94.8% (3 × 400 V AC); 94.5% (3 × 480 V AC)	93.7% (3 × 400 V AC); 93.5% (3 × 480 V AC)
Connection	Push-In spring clamp terminals	
Temperature range	-40...+70 °C, ...+70 °C derating (storage temperature -40...+85 °C)	

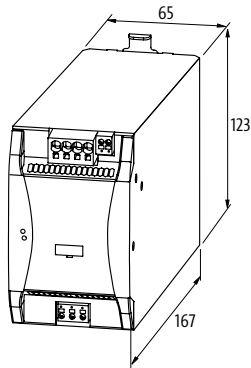
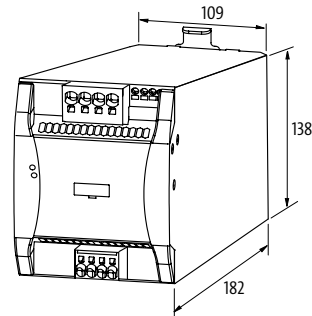
Dimension drawing		
		

Notes		

## POWER SUPPLY UNITS

2-/3-phase

– AS-Interface

– Short-circuit and overload protected

– Alarm contact

Approvals:   

**Emparro®**

OUTPUT: 30...32 V DC



Order Data		Art-No.
30.5 V DC/4 A		85383
<b>Input</b>		
Input voltage	3 × 324...572 V AC/450...745 V DC	
Input current	0.45 A (3 × 360 V AC); 0.3 A (3 × 500 V AC)	
Inrush current after 1 ms	max. 9.5 A (3 × 500 V AC)	
Power factor	0.61 (3 × 400 V AC)	
Frequency	50...60 Hz	
Input fuse (internal)	3 × 6.3 A (T)	
<b>Output</b>		
Output voltage	30.5 V DC (SELV), ±1%; 30...32 V adjustable	
Power Boost	I <sub>out</sub> N × 150% (min. 5 s)	
Output current	4.8 A (45 °C); 4.0 A (60 °C); 2.9 A (70 °C)	
Mains failure bridging time	min. 20 ms (3 × 360 V AC); 5 A (24 V DC)	
Ripple	max. 20 mVrms	
Spikes	max. 50 mV p-p	
Unit protection	Short-circuit and overload protected, permanently by 20% (to 45 °C)	
LED display	LED (green): OK; LED (red): overload, overheating or short-circuit	
Parallel usage/serial usage	max. 3 units	
<b>General data</b>		
Standards	EN 60950-1, EN 61204-3, EN 61000-3-2, SEMI F47	
Relative humidity	5...95%, no condensation	
Protection	IP20	
Efficiency	92.5% (3 × 400 V AC); 91.8% (3 × 480 V AC)	
Connection	Push-In spring clamp terminals	
Mounting method	DIN-rail mountable TH35 (EN 60715)	
Temperature range	-40...+70 °C, ...+70 °C derating (storage temperature -40...+85 °C)	
<b>Dimension drawing</b>		

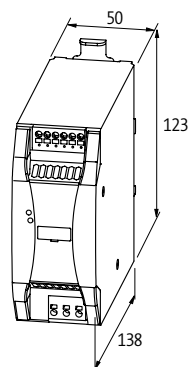

Notes

# POWER SUPPLY UNITS

Single-phase

– IP67

## Emparro®67

OUTPUT: 24 V DC  
Current: 4 A



## Emparro®67

OUTPUT: 24 V DC  
Current: 8 A



Approvals:  UL US  
Listed

Order Data	Art-No.	Art-No.
24 V DC/4 A	9000-11112-1962020	
24 V DC/8 A		9000-11112-2062020

Input		
Input voltage	90...265 V AC/90...265 V DC	
Input current	1.1 A (100 V AC); 0.5 A (240 V AC)	2.1 A (100 V AC); 0.9 A (240 V AC)
Inrush current after 1 ms	max. 8.9 A (230 V AC)	max. 7 A (230 V AC)
Power factor	0.98 (230 V AC)	0.95 (230 V AC)
Connection	7/8" male, 3-pole	
Frequency	50...60 Hz	
Input fuse (internal)	6.3 A (T)	
Output		
Output voltage	24 V DC (SELV), ±2%	
Power Boost	I <sub>out</sub> N × 150% (min. 4 s)	
Output current	4 A	8 A
Connection	7/8" (female), 5-pole	
Mains failure bridging time	min. 45 ms (230 V AC); 4 A (24 V DC)	min. 35 ms (230 V AC); 8 A (24 V DC)
Ripple	max. 20 mVrms	max. 30 mVrms
Spikes	max. 100 mV p-p	max. 300 mV p-p
Unit protection	Short-circuit, overload and temperature	
LED display	LED (green): OK; LED (red): overload, overheating or short-circuit	
Parallel usage/serial usage	max. 3 units/max. 2 units	
General data		
Standards	EN 60950-1, EN 61204-3, EN 55011 A, EN 61000-3-2	
Relative humidity	4...100%	
Protection	IP67	
Efficiency	91.7% (115 V AC); 92.4% (230 V AC)	93.5% (115 V AC); 94.2% (230 V AC)
Mounting method	screw fixing	
Temperature range	-40...+60 °C, ...+70 °C derating (storage temperature -40...+80 °C)	

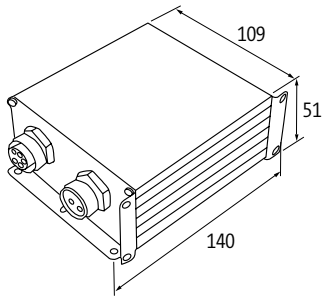
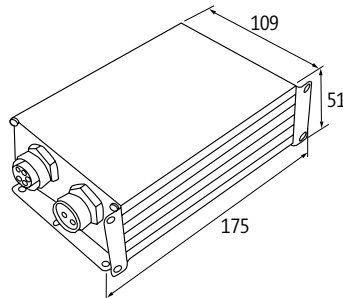
Dimension drawing		
		

Notes		



## POWER SUPPLY UNITS

### Single-phase

- Over current protection device
- 2×MICO 7/8" IOL
- Preventive Diagnostic

### IO-Link

### Emparro®67 Hybrid

OUTPUT: 24...28 V DC  
Current: 10 A



Order Data		Art-No.
24 V DC/10 A		85676
<b>Input</b>		
Input voltage	90...265 V AC/90...265 V DC	
Input current	1.1 A (230 V AC)	
Inrush current after 1 ms	max. 7 A (230 V AC)	
Power factor	0.88 (230 V AC)	
Connection	7/8" male, 3-pole	
Frequency	50...60 Hz	
Input fuse (internal)	6.3 A (T)	
<b>Output</b>		
Output voltage	24 V DC (SELV), ±1%; 24...28 V adjustable	
Output current	max. 8 A (per channel), max. 10 A (total)	
No. of channels	2×MICO (Over current protection device)	
Connection	7/8" (female), 5-pole	
Mains failure bridging time	min. 20 ms (230 V AC)	
Ripple	max. 10 mVrms	
Spikes	max. 150 mV p-p	
Unit protection	Short-circuit, overload and temperature	
LED display	LED (green): OK; LED (red): overload, overheating or short-circuit	
Parallel usage/serial usage	no	
<b>General data</b>		
Standards	EN 60950-1, EN 61204-3, EN 55022 B, EN 61000-3-2	
Relative humidity	4...100%	
Protection	IP67	
Efficiency	91.6% (115 V AC); 92.8% (230 V AC)	
MTBF	430 000 h	
Mounting method	screw fixing	
Temperature range	-25...+50 °C (storage temperature -40...+85 °C)	
<b>Dimension drawing</b>		

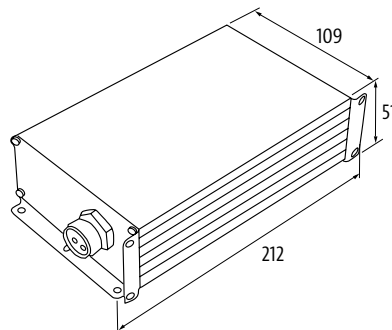

Notes	
	For an explanation of MICO features, see the chapter Intelligent Power Distribution

# POWER SUPPLY UNITS

## 2-/3-phase

– stable output voltage

– Short-circuit and overload protected

Approvals:  

### Evolution

OUTPUT: 22...28 V DC  
Current: 5 A



### Evolution

OUTPUT: 22...28 V DC  
Current: 10 A



Order Data	HxWxD/kg	Art-No.	HxWxD/kg	Art-No.
24 V DC/5 A	132x83x98/1.0	<b>85000</b>		
24 V DC/10 A			132x93x114/1.3	<b>85001</b>
<b>Input</b>				
Input voltage	3 x 324...572 V AC/480...745 V DC			
Input current	3 x 0.45 A		3 x 0.8 A	
Inrush current after 1 ms	max. 10 A		max. 15 A	
Frequency	50...60 Hz			
Primary fusing external	max. 3 x 10 A		3 x 10 A (T)	
<b>Output</b>				
Output voltage	24 V DC (SELV), ±1%; 22...28 V adjustable			
Output current	5 A (+55 °C); 3 A (+70 °C)		10 A (+55 °C); 6.5 A (+70 °C)	
Power Boost	I <sub>out</sub> N x 150% (min. 4 s)			
Mains failure bridging time	min. 30 ms (400 V AC)		min. 19 ms (400 V AC)	
Ripple	max. 50 mVrms			
Spikes	max. 100 mV p-p			
LED display	LED (green): OK; LED (red): overload			
Parallel usage/serial usage	max. 5 units/max. 2 units			
<b>General data</b>				
Standards	EN 60950-1, EN 61204-3, EN 55022 B, EN 61000-3-2, SEMI F47			
Relative humidity	5...95%, no condensation			
Protection	IP20			
Efficiency	86% (3 x 360 V AC); 86% (3 x 520 V AC)		90% (3 x 400 V AC); 90% (3 x 520 V AC)	
Connection	Screw terminals			
Mounting method	DIN-rail mountable TH35 (EN 60715)			
Temperature range	-25...+70 °C (storage temperature -40...+85 °C)			
<b>Dimension drawing</b>				

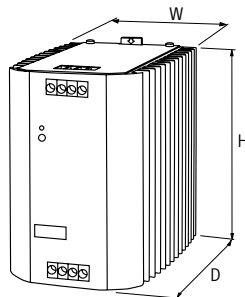

### Notes

## POWER SUPPLY UNITS

### 2-/3-phase

- stable output voltage
- Short-circuit and overload protected



### Evolution

OUTPUT: 22...28 V DC  
Current: 20 A



### Evolution

OUTPUT: 22...28 V DC  
Current: 40 A



Order Data	HxWxD/kg	Art-No.	HxWxD/kg	Art-No.
24 V DC/20 A	132x113x136/2.0	<b>85002</b>		
24 V DC/40 A			132x164x142/3.0	<b>85004</b>
<b>Input</b>				
Input voltage	3 x 324...572 V AC/480...745 V DC			
Input current	3 x 1.3 A		3 x 2.4 A	
Inrush current after 1 ms	max. 19 A			
Frequency	50...60 Hz			
Primary fusing external	max. 3 x 20 A			
<b>Output</b>				
Output voltage	24 V DC (SELV), ±1%; 22...28 V adjustable			
Output current	20 A (+55 °C); 15.8 A (+70 °C)		40 A (+55 °C); 30 A (+70 °C)	
Power Boost	I <sub>out</sub> N x 150% (min. 4 s)			
Mains failure bridging time	min. 19 ms (400 V AC)			
Ripple	max. 50 mVrms			
Spikes	max. 100 mV p-p			
LED display	LED (green): OK; LED (red): overload			
Parallel usage/serial usage	max. 5 units/max. 2 units			
<b>General data</b>				
Standards	EN 60950-1, EN 61204-3, EN 55011 A, EN 61000-3-2, SEMI F47		EN 60950-1, EN 61204-3, EN 55022 B, EN 61000-3-2, SEMI F47	
Relative humidity	5...95%, no condensation			
Protection	IP20			
Efficiency	90% (3 x 400 V AC); 89% (3 x 520 V AC)		91% (3 x 400 V AC); 90% (3 x 520 V AC)	
Connection	Screw terminals			
Mounting method	DIN-rail mountable TH35 (EN 60715)			
Temperature range	-25...+70 °C (storage temperature -40...+85 °C)			
<b>Dimension drawing</b>				

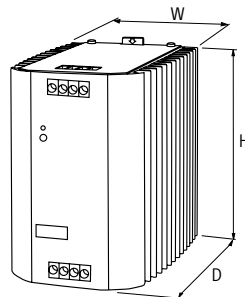

<b>Notes</b>
--------------

# POWER SUPPLY UNITS

## 2-/3-phase

- stable output voltage
- Short-circuit and overload protected
- Varnished board

Approvals:  

### Evolution+

OUTPUT: 22...28 V DC  
Current: 5 A



### Evolution+

OUTPUT: 22...28 V DC  
Current: 10 A



Order Data	HxWxD/kg	Art-No.	HxWxD/kg	Art-No.
24 V DC/5 A	132x83x98/1.0	85640		
24 V DC/10 A			132x93x114/1.2	85641
<b>Input</b>				
Input voltage	3 x 324...572 V AC/480...745 V DC			
Input current	3 x 0.45 A		3 x 0.8 A	
Inrush current after 1 ms	max. 10 A		max. 15 A	
Frequency	50...60 Hz			
Primary fusing external	3 x 10 A (T)			
<b>Output</b>				
Output voltage	24 V DC (SELV), ±1%; 22...28 V adjustable			
Output current	5 A (+55 °C); 3 A (+70 °C)		10 A (+55 °C); 6.5 A (+70 °C)	
Power Boost	I <sub>out</sub> N x 150% (min. 4 s)			
Mains failure bridging time	min. 30 ms (400 V AC)		min. 19 ms (400 V AC)	
Ripple	max. 50 mVrms			
Spikes	max. 100 mV p-p			
LED display	LED (green): OK; LED (red): overload			
Parallel usage/serial usage	max. 5 units/max. 2 units			
Alarm output	electronic relay max. 30 V DC/0.1 A, group alarm			
<b>General data</b>				
Standards	EN 60950-1, EN 61204-3, EN 55022 B, EN 61000-3-2, SEMI F47			
Relative humidity	5...95%, no condensation			
Protection	Varnished board			
Protection	IP20			
Efficiency	86% (3 x 400 V AC); 86% (3 x 520 V AC)		90% (3 x 400 V AC); 90% (3 x 520 V AC)	
Connection	Screw terminals			
Mounting method	DIN-rail mountable TH35 (EN 60715)			
Temperature range	-25...+70 °C (storage temperature -40...+85 °C)			

### Dimension drawing

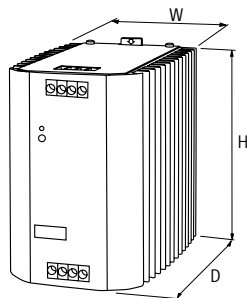

### Notes

## POWER SUPPLY UNITS

### 2-/3-phase

- stable output voltage
- Short-circuit and overload protected
- Varnished board



#### Evolution+

OUTPUT: 22...28 V DC  
Current: 20 A



#### Evolution+

OUTPUT: 22...28 V DC  
Current: 40 A



Order Data	H×W×D/kg	Art-No.	H×W×D/kg	Art-No.
24 V DC/20 A	132×113×136/2.0	<b>85642</b>		
24 V DC/40 A			132×164×142/3.0	<b>85644</b>
<b>Input</b>				
Input voltage	3 × 324...572 V AC/480...745 V DC			
Input current	3 × 1.3 A		3 × 2.4 A	
Inrush current after 1 ms	max. 19 A		–	
Frequency	50...60 Hz			
Primary fusing external	max. 3 × 20 A			
<b>Output</b>				
Output voltage	24 V DC (SELV), ±1%; 22...28 V adjustable			
Output current	20 A (+55 °C); 15.8 A (+70 °C)		40 A (+55 °C); 30 A (+70 °C)	
Power Boost	I <sub>out</sub> N × 150% (min. 4 s)			
Mains failure bridging time	min. 19 ms (400 V AC)			
Ripple	max. 50 mVrms			
Spikes	max. 100 mV p-p			
LED display	LED (green): OK; LED (red): overload			
Parallel usage/serial usage	max. 5 units/max. 2 units			
Alarm output	electronic relay max. 30 V DC/0.1 A, group alarm			
<b>General data</b>				
Standards	EN 60950-1, EN 61204-3, EN 55011 A, EN 61000-3-2, SEMI F47		EN 60950-1, EN 61204-3, EN 55022 B, EN 61000-3-2, SEMI F47	
Relative humidity	5...95%, no condensation			
Protection	Varnished board			
Protection	IP20			
Efficiency	90% (3 × 400 V AC); 89% (3 × 520 V AC)		91% (3 × 400 V AC); 90% (3 × 520 V AC)	
Connection	Screw terminals			
Mounting method	DIN-rail mountable TH35 (EN 60715)			
Temperature range	-25...+70 °C (storage temperature -40...+85 °C)			
<b>Dimension drawing</b>				

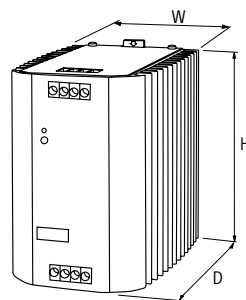

### Notes

## POWER SUPPLY UNITS

2-/3-phase

– stable output voltage

– Short-circuit and overload protected

– Varnished board

Approvals:  Listed

### Evolution+

OUTPUT: 48...56 V DC  
Current: 5 A



### Evolution+

OUTPUT: 48...56 V DC  
Current: 10 A



### Evolution+

OUTPUT: 48...56 V DC  
Current: 20 A



Order Data	HxWxD/kg	Art-No.	HxWxD/kg	Art-No.	HxWxD/kg	Art-No.
48 V DC/5 A	132x93x114/1.4	<b>85009</b>				
48 V DC/10 A			132x113x136/2.0	<b>85010</b>		
48 V DC/20 A					132x164x142/3.0	<b>85011</b>
<b>Input</b>						
Input voltage	3 x 324...572 V AC/480...745 V DC					
Input current	3 x 0.8 A		3 x 1.3 A		3 x 1.9 A	
Inrush current after 1 ms	max. 9 A		max. 23 A		–	
Frequency	50...60 Hz					
Primary fusing external	max. 3 x 20 A					
<b>Output</b>						
Output voltage	48 V DC (SELV), ±1%; 48...56 V adjustable					
Output current	5 A (+55 °C); 3.73 A (+70 °C)		10 A (+55 °C); 8 A (+70 °C)		20 A (+55 °C); 15 A (+70 °C)	
Power Boost	I <sub>out</sub> N x 150% (min. 4 s)					
Mains failure bridging time	min. 17 ms (400 V AC)		min. 24 ms (400 V AC)		min. 17 ms (400 V AC)	
Ripple	max. 50 mVrms					
Spikes	max. 100 mV p-p					
LED display	LED (green): OK; LED (red): overload					
Parallel usage/serial usage	max. 5 units/no					
Alarm output	electronic relay max. 30 V DC/0.1 A, group alarm					
<b>General data</b>						
Standards	EN 60950-1, EN 61204-3, EN 55022 B, EN 61000-3-2					
Relative humidity	5...95%, no condensation					
Protection	Varnished board					
Protection	IP20					
Efficiency	91.3% (3 x 360 V AC); 90.5% (3 x 520 V AC)		92.3% (3 x 360 V AC); 91% (3 x 520 V AC)		92.5% (3 x 360 V AC); 90.5% (3 x 520 V AC)	
Connection	Screw terminals					
Mounting method	DIN-rail mountable TH35 (EN 60715)					
Temperature range	-25...+70 °C (storage temperature -40...+85 °C)					

### Dimension drawing

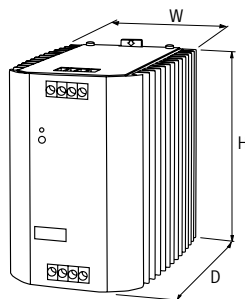

### Notes

## POWER SUPPLY UNITS

### 2-/3-phase

- stable output voltage
- Short-circuit and overload protected

### Evolution

OUTPUT: 12...13.5 V DC  
Current: 20 A



Order Data	H×W×D/kg	Art-No.
12 V DC/20 A	132×93×114/1.3	85016
<b>Input</b>		
Input voltage	3 × 324...572 V AC/480...745 V DC	
Input current	3 × 0.8 A	
Inrush current after 1 ms	max. 15 A	
Frequency	50...60 Hz	
Primary fusing external	3 × 10 A (T)	
<b>Output</b>		
Output voltage	12 V DC (SELV), ±1%; 12...13.5 V adjustable	
Output current	20 A (+55 °C); 15.8 A (+70 °C)	
Power Boost	1out N × 150% (min. 4 s)	
Mains failure bridging time	min. 19 ms (400 V AC)	
Ripple	max. 50 mVrms	
Spikes	max. 100 mV p-p	
LED display	LED (green): OK; LED (red): overload	
Parallel usage/serial usage	max. 5 units/max. 4 units	
Alarm output	electronic relay max. 30 V DC/0.1 A, group alarm	
<b>General data</b>		
Standards	EN 60950-1, EN 61204-3, EN 55022 B, EN 61000-3-2	
Relative humidity	5...95%, no condensation	
Protection	IP20	
Efficiency	89% (3 × 400 V AC); 88% (3 × 520 V AC)	
Connection	Spring clamp terminals	
Mounting method	DIN-rail mountable TH35 (EN 60715)	
Temperature range	-25...+70 °C (storage temperature -40...+85 °C)	
<b>Dimension drawing</b>		

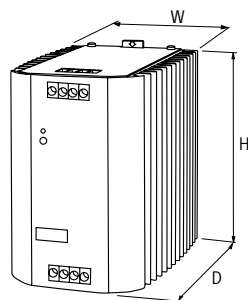

Notes

# POWER SUPPLY UNITS

## Single-phase

– Short-circuit and overload protected

Approvals: 

### Eco-Rail-2

OUTPUT: 23...28 V DC  
Current: 1.3 A



### Eco-Rail-2

OUTPUT: 23...28 V DC  
Current: 2.5 A



### Eco-Rail-2

OUTPUT: 23...28 V DC  
Current: 5 A

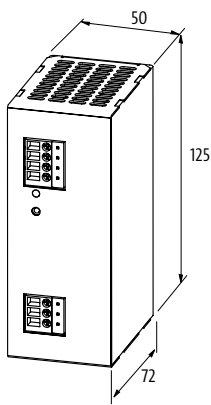
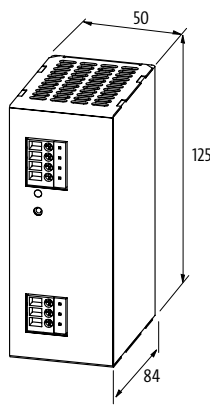
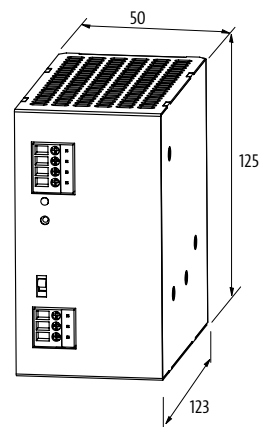

Order Data	Art-No.	Art-No.	Art-No.
24 V DC/1.3 A	<b>85131</b>		
24 V DC/2.5 A		<b>85132</b>	
24 V DC/5 A			<b>85133</b>
<b>Input</b>			
Input voltage	100...240 V AC		
Input current	0.7 A (100 V AC); 0.4 A (240 V AC)	1.3 A (100 V AC); 0.6 A (240 V AC)	2.4 A (100 V AC); 1.2 A (240 V AC)
Inrush current after 1 ms	max. 10 A (230 V AC)		max. 20 A (230 V AC)
Frequency	50...60 Hz		
Input fuse (internal)	2 A (T)	4 A (T)	5 A (T)
<b>Output</b>			
Output voltage	24 V DC $\pm$ 1%; 23...28 V adjustable		
Output current	1.3 A (+40 °C); 1.0 A (+55 °C)	2.5 A (+40 °C); 2.0 A (+55 °C)	5 A (+40 °C); 4 A (+55 °C)
Mains failure bridging time	min. 23 ms (115 V AC); min. 130 ms (230 V AC)	min. 20 ms (115 V AC); min. 100 ms (230 V AC)	min. 45 ms (115 V AC); min. 45 ms (230 V AC)
Ripple	max. 10 mVrms		
Spikes	max. 50 mV p-p		
Unit protection	Short-circuit and overload protected		
LED display	LED (green) for output voltage		
Parallel usage/serial usage	no/yes (max. 2 units)		
<b>General data</b>			
Standards	EN 60950-1, EN 61204-3, EN 61000-3-2		
Relative humidity	20...90%, no condensation		
Protection	IP20		
Efficiency	83% (115 V AC); 84% (230 V AC)	84% (115 V AC); 85% (230 V AC)	87% (115 V AC); 88% (230 V AC)
Connection	Screw terminals		
Mounting method	DIN-rail mountable TH35 (EN 60715)		
Temperature range	0...+40 °C, ...+55 °C derating (storage temperature -20...+85 °C)		
<b>Dimension drawing</b>			
			
<b>Notes</b>			



## POWER SUPPLY UNITS

### Single-phase

– Short-circuit and overload protected

Approvals:  

#### Eco-Rail-2

OUTPUT: 23...28 V DC  
Current: 10 A



#### Eco-Rail-2

OUTPUT: 23...28 V DC  
Current: 20 A

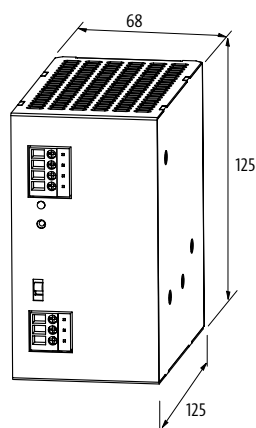
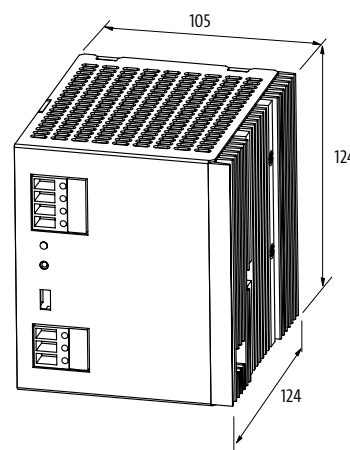

Order Data	Art-No.	Art-No.
24 V DC/10 A	85135	
24 V DC/20 A		85137
<b>Input</b>		
Input voltage	90...132 V AC/173...264 V AC	
Input current	4.3 A (100 V AC); 2.1 A (240 V AC)	7.8 A (100 V AC); 4.0 A (200 V AC)
Inrush current after 1 ms	max. 18 A (230 V AC)	max. 40 A (230 V AC)
Frequency	50...60 Hz	
Input fuse (internal)	5 A (T)	12 A (T)
<b>Output</b>		
Output voltage	24 V DC $\pm$ 1%; 23...28 V adjustable	
Output current	10 A (+40 °C); 7.5 A (+55 °C)	20 A (+40 °C); 16 A (+55 °C)
Mains failure bridging time	min. 12 ms (115 V AC); min. 30 ms (230 V AC)	min. 15 ms (115 V AC); min. 20 ms (230 V AC)
Ripple	max. 10 mVrms	max. 50 mVrms
Spikes	max. 50 mV p-p	max. 100 mV p-p
Unit protection	Short-circuit and overload protected	
LED display	LED (green) for output voltage	
Parallel usage/serial usage	no/yes (max. 2 units)	
<b>General data</b>		
Standards	EN 60950-1, EN 61204-3, EN 61000-3-2	
Relative humidity	20...90%, no condensation	
Protection	IP20	
Efficiency	86% (115 V AC); 87% (230 V AC)	89% (115 V AC); 90% (230 V AC)
Connection	Screw terminals	
Mounting method	DIN-rail mountable TH35 (EN 60715)	
Temperature range	0...+40 °C, ...+55 °C derating (storage temperature -20...+85 °C)	
<b>Dimension drawing</b>		
		
<b>Notes</b>		

# POWER SUPPLY UNITS

## Single-phase

– Short-circuit and overload protected

Approvals:  

### Picco

OUTPUT: 24...28 V DC  
Current: 0.42 A



### Picco

OUTPUT: 24...28 V DC  
Current 1.25 A



### Picco

OUTPUT: 24...28 V DC  
Current: 2.5 A



### Picco

OUTPUT: 24...28 V DC  
Current: 4.2 A

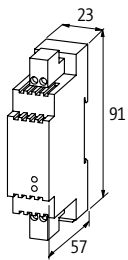
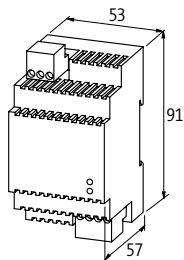
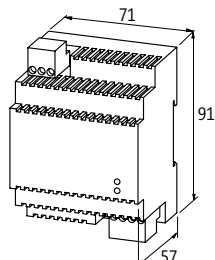
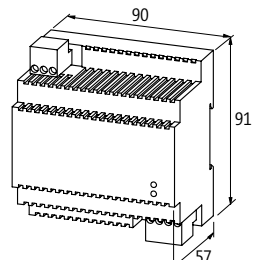

Order Data	Art-No.	Art-No.	Art-No.	Art-No.
Screw terminals	87011	87013	87015	87017
Spring clamp plug-in terminals	87111	87113	87115	87117
<b>Input</b>				
Input voltage	100...240 V AC/120...370 V DC			
Input current	0.2 A (115 V AC); 0.12 A (230 V AC)	0.6 A (115 V AC); 0.4 A (230 V AC)	1.1 A (115 V AC); 0.6 A (230 V AC)	1.7 A (115 V AC); 1 A (230 V AC)
Inrush current after 1 ms	max. 30 A	max. 40 A	max. 60 A	
Frequency	50...60 Hz			
Primary fusing external	max. 10 A		max. 16 A	max. 10 A
<b>Output</b>				
Output voltage	24 V DC (SELV), ±1%; 24...28 V adjustable			
Output current	0.42 A (+50 °C); 0.042 A (+70 °C)	1.25 A (+50 °C); 0.125 A (+70 °C)	2.5 A (+50 °C); 0.25 A (+70 °C)	4.2 A (+50 °C); 0.42 A (+70 °C)
Mains failure bridging time	10...25 ms (115 V AC)			
Ripple	max. 20 mVrms			
Spikes	max. 100 mV p-p			
Unit protection	Short-circuit and overload protected			
LED display	LED (green) for output voltage			
Parallel usage/serial usage	max. 5 units/max. 2 units			
<b>General data</b>				
Standards	EN 60950-1, EN 61204-3, EN 55022 B, EN 61000-3-2			
Relative humidity	20...90%, no condensation			
Protection	IP20			
Efficiency	79% (110 V AC); 80% (230 V AC)	86% (110 V AC); 88% (230 V AC)		
Mounting method	DIN-rail mountable TH35 (EN 60715)			
Temperature range	0...+50 °C, ...+60 °C derating (storage temperature -25...+85 °C)			
<b>Dimension drawing</b>				
				
<b>Notes</b>				

# POWER SUPPLY UNITS

stay connected

## Single-phase

– Short-circuit and overload protected

Approvals:

### Picco

OUTPUT: 12...15 V DC  
Current: 0.85 A



### Picco

OUTPUT: 12...15 V DC  
Current: 2.5 A



### Picco

OUTPUT: 12...15 V DC  
Current: 4.5 A



### Picco

OUTPUT: 12...15 V DC  
Current: 6 A



Order Data	Art-No.	Art-No.	Art-No.	Art-No.
Screw terminals	87012	87014	87016	87018
Spring clamp plug-in terminals	87112	87114	87116	87118
<b>Input</b>				
Input voltage	100...240 V AC/120...370 V DC			
Input current	0.2 A (115 V AC); 0.12 A (230 V AC)	0.6 A (115 V AC); 0.4 A (230 V AC)	1 A (115 V AC); 0.58 A (230 V AC)	1.3 A (115 V AC); 0.75 A (230 V AC)
Inrush current after 1 ms	max. 30 A	max. 40 A	max. 60 A	
Frequency	50...60 Hz			
Primary fusing external	max. 10 A		max. 16 A	max. 10 A
<b>Output</b>				
Output voltage	12 V DC (SELV), ±1%; 12...15 V adjustable			
Output current	0.85 A (+50 °C); 0.085 A (+70 °C)	2.5 A (+50 °C); 0.25 A (+70 °C)	4.5 A (+50 °C); 0.45 A (+70 °C)	6 A (+50 °C); 0.6 A (+70 °C)
Mains failure bridging time	10...25 ms (115 V AC)			
Ripple	max. 20 mVrms			
Spikes	max. 100 mV p-p			
Unit protection	Short-circuit and overload protected			
LED display	LED (green) for output voltage			
Parallel usage/serial usage	max. 5 units/max. 2 units			
<b>General data</b>				
Standards	EN 60950-1, EN 61204-3, EN 55022 B, EN 61000-3-2			
Relative humidity	20...90%, no condensation			
Protection	IP20			
Efficiency	86% (110 V AC); 88% (230 V AC)			
Mounting method	DIN-rail mountable TH35 (EN 60715)			
Temperature range	0...+50 °C, ...+60 °C derating (storage temperature -25...+85 °C)			
<b>Dimension drawing</b>				
<b>Notes</b>				

## POWER SUPPLY UNITS

Mounting accessories			Art-No.
	<b>Label plates</b> KES 20 × 8 (white)	(10 pieces/2 plates)	<b>996067</b>
	<b>DIN-Rail Clip</b> DIN-rail mountable TH35 (EN 60715)		<b>85148</b>

# UPS SYSTEMS / BUFFER / REDUNDANCY MODULES

- Stable power supply
- Protection of processes
- Increase of machine availability

## UPS MODULE OR BUFFER MODULE ON THE BASIS OF CAPACITORS?

The UPS module Emparro ACCUcontrol is the right solution if a longer power failure have to be bridged without having to deal with failures and downtimes in production. Thanks to the externally connected lead battery, even a bridging time of several hours is possible.

Emparro Cap works based on ultra condensers, is maintenance-free for its entire service life and is the right solution if a certain amount of power is required to shut machines and control systems down in a structured manner.

### Project matrix

Load current	Seconds		Minutes						Hours			
	1	16	1	2	5	10	15	30	1	3	5	10
0.5A	●	●	●	●	●	●	●	●	●	●	●	●
1A	●	●	●	●	●	●	●	●	●	●	●	●
2A	●	●	●	●	●	●	●	●	●	●	●	●
5A	●	●	●	●	●	●	●	●	●	●	●	●
10A	●	●	●	●	●	●	●	●	●	●	●	●
15A	●	●	●	●	●	●	●	●	●	●	●	●
20A	●	●	●	●	●	●	●	●	●	●	●	●
40A	●	●	●	●	●	●	●	●	●	●	●	●

- MB Cap 20 A/0.2 s
- MB Cap Ultra 3 A/7 s
- MB Cap Ultra 10 A/38 s
- Emparro Cap 20 A/1.0 s
- MB Cap Ultra 20 A/16 s
- MB Cap Ultra 40 A/3.6 s
- Emparro ACCUControl 20 A
- Emparro ACCUControl 40 A

## UPS systems / Buffer / Redundancy modules



### UPS systems

- Predictive Maintenance
- Mini USB for connection to an industrial PC

Page 1.3.1



### Buffer modules

- Maintenance-free ultra capacitors
- Buffer time more than 1 second at full load of 20 A
- Metal housing

Page 1.3.2



### Buffer modules

- Maintenance-free ultra capacitors

Page 1.3.3



### Redundancy modules

Page 1.3.6

# UPS-SYSTEMS / BUFFER- / REDUNDANCY MODULES

UPS systems

Emparro® ACCUcontrol

Emparro® ACCUcontrol



Approvals: UL Listed

**Circuit diagram**

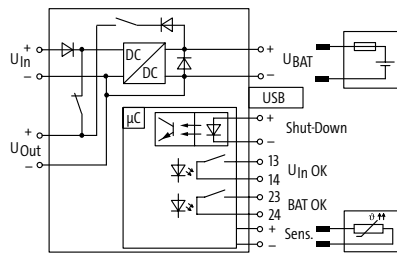

Order Data	Art-No.	Art-No.
24 V DC/20 A	85414	
24 V DC/40 A		85415

Technical Data	
Sensor type	KTY 81-210 (Art.No. 89600)
Battery type	Lead battery (max. 40 Ah, sealed)
Input	
Input voltage	21.6...30 V DC (buffer operation)
Input current	max. 23 A   max. 43 A
Loading current	2 A
Output	
Output voltage	27.7...19.2 V DC
Output current	max. 20 A   max. 40 A
Control inputs	
Input voltage shutdown (SH)	24 V DC (6...45 V DC), potential free
Control outputs	
Battery (BAT OK)	min. 5 V DC, 1 mA; max. 30 V DC, 100 mA
Input voltage (Uin OK)	min. 5 V DC, 1 mA; max. 30 V DC, 100 mA
General data	
Connection	Push-In Spring clamp terminals, Mini-USB
Mounting method	DIN-rail mountable TH35-7.5/TH35-15 (EN 60715)
Temperature range	-25...+45 °C

**Dimension drawing**

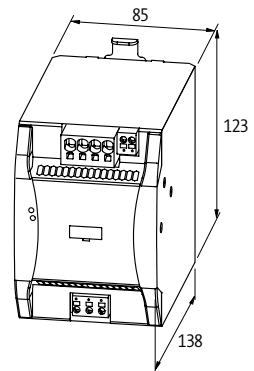
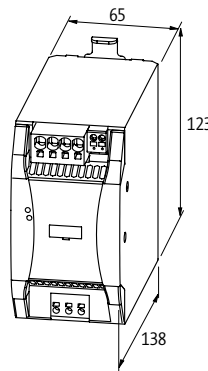

**Notes**

The required batteries can be found at the end of chapter 1.3.

UPS-Systems / Buffer- / Redundancy Modules

# UPS-SYSTEMS / BUFFER- / REDUNDANCY MODULES

## Buffer modules

### Emparro® Cap 20/24 1.0s

1.0 s (20 A); 40 s (1 A)



### Emparro® Cap 20/48 0.1s

0.1 s (20 A); 2 s (1 A)



Approvals:  Listed

## Circuit diagram

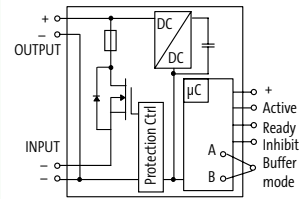
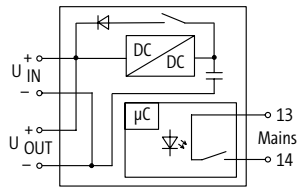

Order Data	Art-No.	Art-No.
24 V DC/20 A	85458	
48 V DC/20 A		85459
Input		
Input voltage	21.6...26.4 V DC	46...56 V DC (SELV/PELV)
Input current	20 A	60 mA
Inrush current	max. 25 A	–
Protection of voltage spikes	–	max. 72 V DC
Loading time	max. 75 s	20...45 s
Loading current	max. 3 A	max. 500 mA
Output		
Output voltage	25.5...19 V DC ±2%	48 V DC (46...56 V DC)
Output current	max. 20 A	
Current limit	65 A	26 A
Buffer time	1.0 s (20 A); 40 s (1 A)	0.1 s (20 A); 2 s (1 A)
Parallel circuit	possible	
Ripple	–	max. 200 mV p-p
General data		
Standards	EN 61000-6-2, EN 61000-6-4	EN 61000-6-2, EN 61000-6-3, EN 55022 B
Mounting method	DIN-rail mountable TH35-7.5/TH35-15 (EN 60715)	DIN-rail mountable TH35 (EN 60715)
Efficiency	90%	99%
Temperature range	-40...+60 °C (storage temperature -40...+60 °C)	-25...+60 °C, ...+70 °C derating (storage temperature -40...+85 °C)
Dimension drawing		

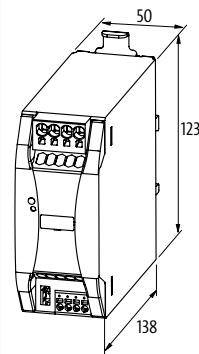
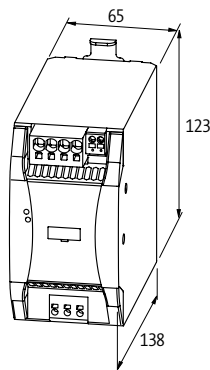

## Notes

# UPS-SYSTEMS / BUFFER- / REDUNDANCY MODULES

## Buffer modules

### MB Cap Ultra 3/24 7s

7 s (3 A); 21 s (1 A)



### MB Cap Ultra expansion module 3/24 12s

12 s (3 A); 36 s (1 A)



Approvals:  UL<sup>us</sup>  
Listed

## Circuit diagram

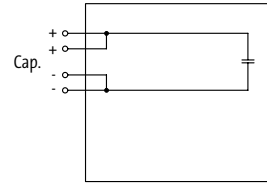
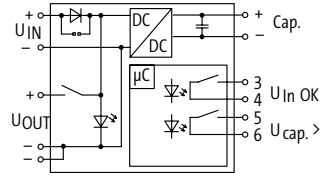

Order Data	Art-No.	Art-No.
24 V DC/3 A	<b>85460</b>	use with Art-No. 85460
<b>Input</b>		
Input voltage	20.4...26.4 V DC	0...26.4 V DC
Input current	3 A	
Loading time	min. 25 s	–
<b>Output</b>		
Output voltage	23 V DC ±2%	0...26.4 V DC
Output current	max. 3 A (+60 °C)	
Buffer time	7 s (3 A); 21 s (1 A)	12 s (3 A); 36 s (1 A)
<b>General data</b>		
Standards	EN 60950, EN 50178, SELV/PELV	
Mounting method	DIN-rail mountable TH35 (EN 60715)	
Efficiency	90%	
Temperature range	-20...+60 °C (storage temperature -20...+60 °C)	

## Dimension drawing

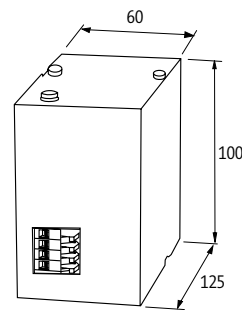
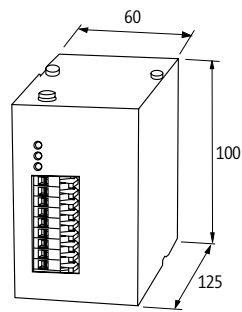

## Notes



# UPS-SYSTEMS / BUFFER- / REDUNDANCY MODULES

## Buffer modules

### MB Cap Ultra 10/24 38s

38 s (10 A); 380 s (1 A)



### MB Cap Ultra 20/24 16s

16 s (20 A); 320 s (1 A)



### MB Cap Ultra 40/24 3.6s

3.6 s (40 A); 170 s (1 A)



Approvals: UL US Listed

## Circuit diagram

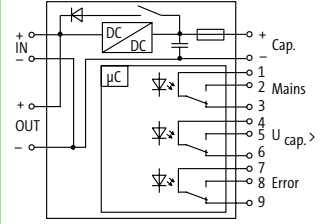
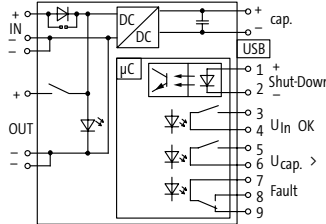
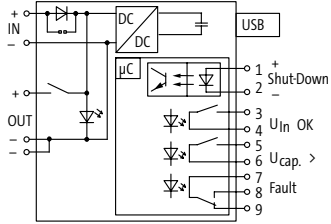

Order Data	Art-No.	Art-No.	Art-No.
24 V DC/10 A	85467		
24 V DC/20 A		85468	
24 V DC/40 A			85469
Input			
Input voltage	10.5...15 V DC; 24...27 V DC	24...29 V DC	21.6...26.4 V DC
Input current	10 A	20 A	40 A
Inrush current	max. 35 A/2 ms	max. 36.5 A/2 ms	max. 36.5 A
Loading time	typ. 100 s; max. 210 s	typ. 40 s; max. 500 s	typ. 140 s; max. 300 s
Output			
Output voltage	11.3 V DC ±4%; 23.3 V DC ±2%	23.3 V DC ±2%	25.5...19 V DC ±2%
Output current	max. 10 A (+60 °C)	max. 20 A (+60 °C)	max. 40 A (+60 °C)
Buffer time	38 s (10 A); 380 s (1 A)	16 s (20 A); 320 s (1 A)	3.6 s (40 A); 170 s (1 A)
General data			
Standards	EN 60950, EN 50178, SELV/PELV	EN 60950-1, EN 61204-3, EN 55011 A	EN 61000-6-2, EN 61000-6-4
Mounting method	DIN-rail mountable TH35-7.5/TH35-15 (EN 60715)		
Efficiency	90%		
Temperature range	-20...+60 °C (storage temperature -20...+60 °C)		
Dimension drawing			

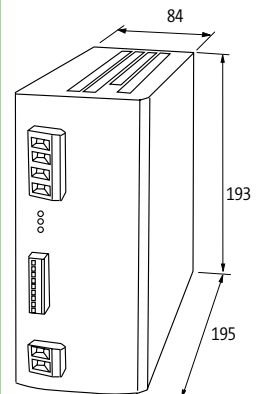
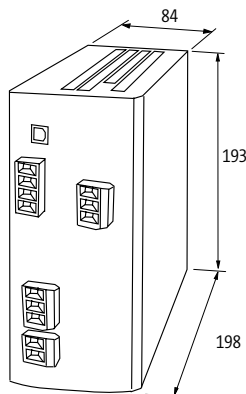
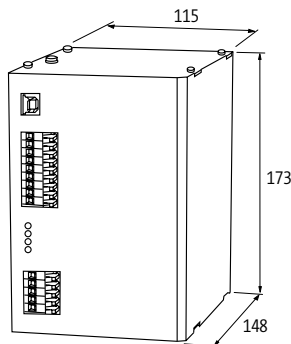

## Notes

UPS-Systems / Buffer- / Redundancy Modules

# UPS-SYSTEMS / BUFFER- / REDUNDANCY MODULES

## Buffer modules

### MB Cap 20/24 0.2s

0.2 s (20 A); 4 s (1 A)



Approvals:  UL<sup>us</sup>  
Listed

### Circuit diagram

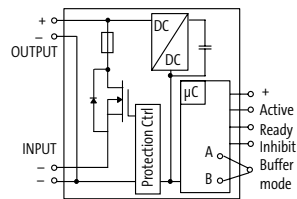

### Order Data

24 V DC/20 A

Art-No.

85394

### Input

Input voltage 23...30 V DC (SELV/PELV)

Input current 85 mA

Protection of voltage spikes max. 35 V DC

Loading time 20...45 s

Loading current max. 500 mA

### Output

Output voltage 24 V DC (22...28 V DC)

Output current max. 20 A (+70 °C)

Current limit 26 A

Buffer time 0.2 s (20 A); 4 s (1 A)

Ripple max. 200 mV p-p

Parallel circuit possible

### General data

Standards EN 61000-6-2, EN 61000-6-3, EN 55022 B, EN 60950-1, SELV

Mounting method DIN-rail mountable TH35 (EN 60715)

Efficiency 95%

Temperature range 0...+70 °C (storage temperature -25...+85 °C)

### Dimension drawing

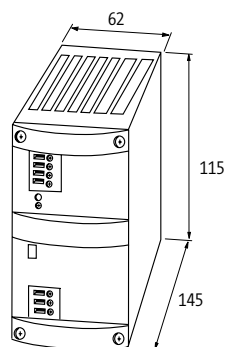

### Notes

# UPS-SYSTEMS / BUFFER- / REDUNDANCY MODULES

## Redundancy modules

### MB Redundancy Balance 2 × 20/24

### MB Redundancy Balance 2 × 20/24

Auto-Balancing (50/50)



Approvals:  

#### Circuit diagram

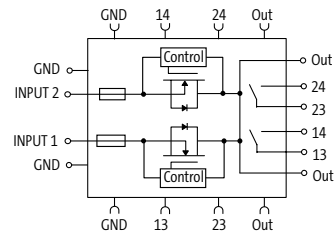
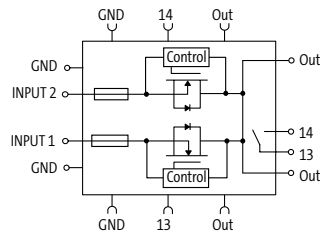

Order Data	Art-No.	Art-No.
24 V DC/2 × 20 A/1 × 40 A	85495	85496

Input		
Input voltage	24 V DC (18...30 V DC)	
Input current	2 × 20 A	
Total current	max. 40 A	
Invers-polarity protection	max. 30 V DC	
Auto-Balancing (50/50)	no	yes
Output		
Output voltage	24 V DC (18...30 V DC)	
Output current	26 A (-25...+40 °C)	
LED display	LED (red/green)	
Parallel usage/serial usage	2 units: 40 A (-25...+60 °C); 52 A (-25...+40 °C)/-	
Alarm output	potential free (relay contact) for input voltage	potential free (relay contact) for input voltage/load distribution

General data		
Standards	EN 61000-6-2, EN 61000-6-3	
Bridging concept	two sides, with spring clamp terminals or bridge set (max. 40 A)	
Relative humidity	5...95%, no condensation	
Efficiency	99.5%	
Connection	Spring clamp terminals	
Mounting method	DIN-rail mountable TH35 (EN 60715)	
Temperature range	-25...+60 °C (storage temperature -40...+85 °C)	

#### Dimension drawing

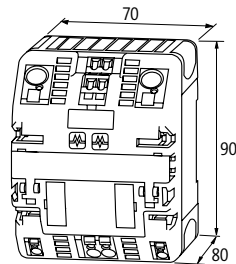

#### Notes

UPS-Systems / Buffer- / Redundancy Modules

## Redundancy modules

## MB Diode

Approvals:  **UL**  
Listed



### Circuit diagram

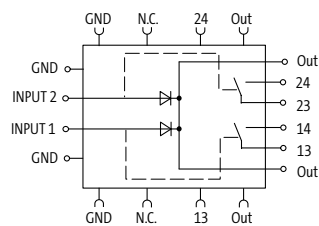

### Order Data

24 V DC/2 × 20 A/1 × 40 A

### Art-No.

85396

### Input

Input voltage	24 V DC (21...30 V DC)
Input current	2 × 20 A/1 × 40 A
Total current	max. 40 A
Invers-polarity protection	internal protection against reverse polarization up to 60 V DC
Auto-Balancing (50/50)	no

### Output

Output voltage	24 V DC (21...30 V DC)
Output current	20 A (-25...+55 °C); 40 A (-25...+40 °C)
Overload	at 20 A +50% for 4 s
LED display	LED (green)
Alarm output	potential free per channel (relay contact)

### General data

Standards	EN 61000-6-2, EN 61000-6-3
Bridging concept	two sides, with spring clamp terminals or bridge set (max. 40 A)
Relative humidity	5...95%, no condensation
Power loss	U (approx. 0.5 V) × I
Efficiency	97%
Connection	Spring clamp terminals
Mounting method	DIN-rail mountable TH35 (EN 60715)
Temperature range	-25...+55 °C (storage temperature -25...+85 °C)

### Dimension drawing

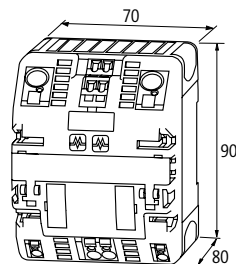

### Notes

## UPS-SYSTEMS / BUFFER- / REDUNDANCY MODULES

Accessories			Art-No.
	<b>Lead battery</b> 1.2 Ah 96×69×105 mm/2 kg	for Emparro® ACCUcontrol	<b>89550</b>
	<b>Lead battery</b> 7 Ah 115×174.5×159 mm/2.32 kg	for Emparro® ACCUcontrol	<b>89552</b>
	<b>Lead battery</b> 12 Ah 115×240.5×159 mm/3.7 kg	for Emparro® ACCUcontrol	<b>89553</b>
	<b>Lead battery</b> 17 Ah 170×155×182 mm/18 kg	for Emparro® ACCUcontrol	<b>89554</b>
	<b>Lead battery</b> 24 Ah 137×335×200 mm/20 kg	for Emparro® ACCUcontrol	<b>89555</b>



# MICO INTELLIGENT POWER DISTRIBUTION

- Monitor
- Detect
- React

## FIRST CLASS POWER DISTRIBUTION

MICO is the intelligent power distribution module from Murrelektronik for 24 VDC. It monitors currents, indicates when approaching the maximum load and make targeted circuit isolations during overload or short circuit conditions. This makes sure systems run at maximum capacity.

- Convenient handling – installation without tools
- Diagnosis on location or via the controller
- Patented tripping characteristics for optimal switch-off time

### Mico Pro®

 <p><b>Mico Pro® PM</b></p> <ul style="list-style-type: none"> <li>• Power module</li> <li>• Cover plate included</li> <li>• Cumulative signal output</li> </ul> <p style="text-align: right;"><i>Page 1.4.1</i></p>	 <p><b>Mico Pro® PD</b></p> <ul style="list-style-type: none"> <li>• Potential distributor</li> <li>• Multiplication of secured channels or potentials</li> </ul> <p style="text-align: right;"><i>Page 1.4.1</i></p>
 <p><b>Mico Pro® fix</b></p> <ul style="list-style-type: none"> <li>• Preset current ranges</li> <li>• Preventive diagnostics</li> </ul> <p style="text-align: right;"><i>Page 1.4.2</i></p>	 <p><b>Mico Pro® flex</b></p> <ul style="list-style-type: none"> <li>• Adjustable current ranges</li> <li>• Channels with remote switch on/off function</li> <li>• Preventive diagnostics</li> </ul> <p style="text-align: right;"><i>Page 1.4.3</i></p>

### MICO

 <p><b>MICO+</b></p> <ul style="list-style-type: none"> <li>• Adjustable current ranges</li> <li>• Channels with remote switch on/off function</li> <li>• Preventive diagnostics</li> </ul> <p style="text-align: right;"><i>Page 1.4.4</i></p>	 <p><b>MICO</b></p> <ul style="list-style-type: none"> <li>• Adjustable current ranges</li> <li>• Channels with remote switch on function</li> <li>• Group alarm output</li> </ul> <p style="text-align: right;"><i>Page 1.4.6</i></p>
 <p><b>MICO BASIC</b></p> <ul style="list-style-type: none"> <li>• Preset current ranges</li> <li>• Small size</li> </ul> <p style="text-align: right;"><i>Page 1.4.10</i></p>	 <p><b>MICO FUSE</b></p> <ul style="list-style-type: none"> <li>• Socket for glass tube fuses 5 × 20 mm</li> </ul> <p style="text-align: right;"><i>Page 1.4.13</i></p>

**EXAMPLE: Why don't circuit breakers trigger reliably in a 24 VDC system?**

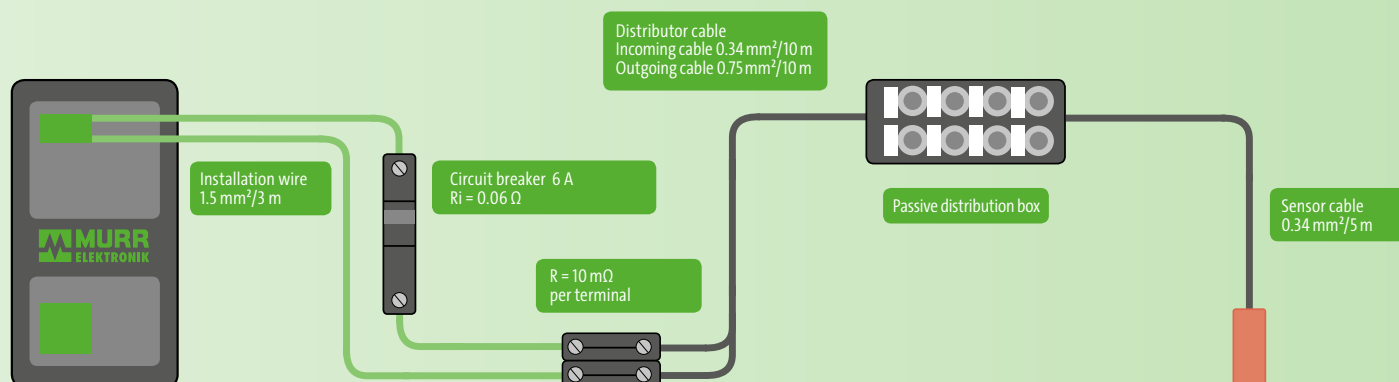

Specific resistance of copper ( $\rho$ )	= 0.0178 ( $\Omega \times \text{mm}^2 / \text{m}$ )
Wire resistance:	$R = \frac{(\rho) \times l}{A} = \frac{0.0178 \times (2 \times 3 \text{ m})}{1.5 \text{ mm}^2} = 0.07 \Omega$
Distributor cable resistance:	$R = \frac{(\rho) \times l}{A} = \frac{0.0178 \times (2 \times 10 \text{ m})}{(0.34 + 0.75 \text{ mm}^2) / 2} = 0.65 \Omega$
Sensor cable resistance:	$R = \frac{(\rho) \times l}{A} = \frac{0.0178 \times (2 \times 5 \text{ m})}{0.34 \text{ mm}^2} = 0.52 \Omega$
Inner resistance of circuit breaker and connection terminals	= 0.08 $\Omega$
<b>Total loop resistance</b>	<b>= 1.32 <math>\Omega</math></b>

Calculation of maximum possible current flow  $I = \frac{U}{R} = \frac{24 \text{ V}}{1.32 \Omega} = \underline{\underline{18.18 \text{ A}}}$   
(limited by loop resistance)

Required tripping current of the 6 A circuit breaker Type C  
 $14 \times I_{\text{Nenn}} = 14 \times 6 \text{ A} = \underline{\underline{84 \text{ A}}}$



Tripping current      Max. current flow  
 84 A                      >      18.18 A

# INTELLIGENT POWER DISTRIBUTION

## Over current protection device

### – Power supplies

### Mico Pro® PM 24 V DC/40 A

Power module  
Cover plate included



### Mico Pro® PD 2x12

Potential distributor  
1 channel (x11)



### Mico Pro® PD 2x2x06

Potential distributor  
2 channels per (x5)

Approvals:

Order Data	Art-No.	Art-No.	Art-No.
40 A	9000-41190-0000000		
20 A		9000-41000-0000212	
2 x 20 A			9000-41000-0002206
<b>Input</b>			
Operating voltage	12 V DC; 24 V DC (9...30 V DC)	12 V DC, 24 V DC	
Total current	max. 40 A	max. 20 A	max. 2 x 20 A
<b>Output</b>			
Parallel usage/serial usage	-/Selectivity in 2 levels	–	
<b>Control inputs</b>			
Input voltage (ON)	9...30 V DC	–	
Impulse length (ON)	"high" 120 ms	–	
Input voltage (CTRL)	9...30 V DC	–	
Impulse length (CTRL)	OFF "high" 40/400 ms, ON "high" 20/200 ms	–	
<b>Control outputs</b>			
Early warning (90%)	max. 30 V AC/DC	–	
Group alarm output	max. 30 V AC/DC	–	
<b>Connections (IN)</b>			
Connection	Bridge system		
<b>Connections (OUT)</b>			
Connection	Push-In spring clamp terminals		
Cross section (rigid)	0.75...16 mm <sup>2</sup> (AWG 20...4)	0.2...2.5 mm <sup>2</sup> (AWG 24...14)	
Cross section (flex)	0.75...16 mm <sup>2</sup> (AWG 20...4)	0.2...2.5 mm <sup>2</sup> (AWG 24...14)	
<b>General data</b>			
Protection	IP20		
Bridging concept	Bridge set (max. 40 A)		
Mounting method	DIN-rail mountable TH35 (EN 60715)		
Temperature range	-25...+55 °C (storage temperature -40...+80 °C)		
Dimensions H x W x D	130x24x114 mm		

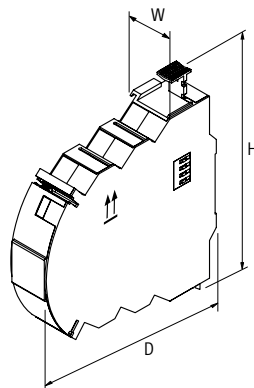

Notes
-------



# INTELLIGENT POWER DISTRIBUTION

## Over current protection device

– preset current ranges

Approvals:   

### Mico Pro® fix

1 channel



### Mico Pro® fix

1 channel



### Mico Pro® fix

2 channels



### Mico Pro® fix

4 channels



Order Data	Art-No.	Art-No.	Art-No.	Art-No.
2 A	9000-41011-0200000		9000-41012-0200000	9000-41014-0200000
4 A	9000-41011-0400000		9000-41012-0400000	9000-41014-0400000
6 A	9000-41011-0600000		9000-41012-0600000	9000-41014-0600000
8 A	9000-41011-0800000			
10 A	9000-41011-1000000			
16 A		9000-41011-1600000		
<b>Input</b>				
Operating voltage	12 V DC; 24 V DC (9...30 V DC)			
Total current	max. 40 A			
<b>Output</b>				
No. of channels	1		2	4
Inrush capacity	max. 30 mF			
Tolerance	0...+20%			
Parallel usage/serial usage	-/Selectivity in 2 levels			
<b>Control inputs</b>				
Input voltage (ON)	via power module			
Impulse length (ON)	via power module			
Input voltage (CTRL)	via power module			
Impulse length (CTRL)	via power module			
<b>Control outputs</b>				
Group alarm output	via power module			
Early warning (90%)	via power module			
<b>Connections (IN)</b>				
Connection	Bridge system			
<b>Connections (OUT)</b>				
Connection	Push-In spring clamp terminals			
Cross section (rigid)	0.2...2.5 mm <sup>2</sup> (AWG 24...14)			
Cross section (flex)	0.2...4 mm <sup>2</sup> (AWG 24...12)			
<b>General data</b>				
Protection	IP20			
Bridging concept	Bridge set (max. 40 A)			
Mounting method	DIN-rail mountable TH35 (EN 60715)			
Temperature range	-25...+55 °C (storage temperature -40...+80 °C)			
Dimensions H × W × D	130×8×114 mm	130×12×114 mm	130×24×114 mm	
<b>Dimension drawing</b>				

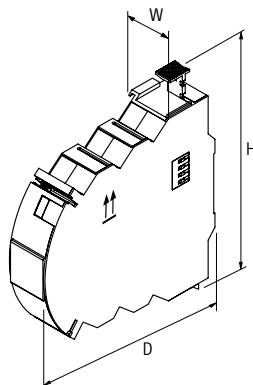

# INTELLIGENT POWER DISTRIBUTION

## Over current protection device

- adjustable current ranges
- channel-specific messages

Approvals:

### Mico Pro® flex

1 channel



### Mico Pro® flex

1 channel



### Mico Pro® flex

2 channels



### Mico Pro® flex

4 channels



Order Data	Art-No.	Art-No.	Art-No.	Art-No.
1, 2, 3, 4, 5, 6, 7, 8, 9, 10 A	9000-41091-0101000		9000-41092-0101000	9000-41094-0101000
11, 12, 13, 14, 15, 16, 17, 18, 19, 20 A		9000-41091-1102000		
<b>Input</b>				
Operating voltage	12 V DC; 24 V DC (9...30 V DC)			
Total current	max. 40 A			
<b>Output</b>				
No. of channels	1		2	4
Inrush capacity	max. 30 mF			
Tolerance	0...+20%	-5...+15 %	0...+20%	
Parallel usage/serial usage	-/Selectivity in 2 levels			
<b>Control inputs</b>				
Input voltage (ON)	9...30 V DC			
Impulse length (ON)	"high" 120 ms			
Input voltage (CTRL)	9...30 V DC			
Impulse length (CTRL)	OFF "high" 40/400 ms, ON "high" 20/200 ms			
<b>Control outputs</b>				
Group alarm output	via power module			
Early warning (90%)	like operating voltage - max. 20 mA, via power module			
<b>Connections (IN)</b>				
Connection	Bridge system			
<b>Connections (OUT)</b>				
Connection	Push-In spring clamp terminals			
Cross section (rigid)	0.2...2.5 mm <sup>2</sup> (AWG 24...14)			
Cross section (flex)	0.2...4 mm <sup>2</sup> (AWG 24...12)			
<b>General data</b>				
Protection	IP20			
Bridging concept	Bridge set (max. 40 A)			
Mounting method	DIN-rail mountable TH35 (EN 60715)			
Temperature range	-25...+55 °C (storage temperature -40...+80 °C)	-25...+50 °C (storage temperature -40...+80 °C)	-25...+55 °C (storage temperature -40...+80 °C)	
Dimensions H × W × D	130×8×114 mm	130×12×114 mm	130×24×114 mm	

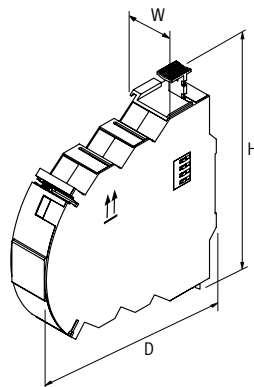

Notes

# INTELLIGENT POWER DISTRIBUTION

## Over current protection device

- adjustable current ranges
- early warning (90%)

Approvals:   

## MICO+ 4.4

4 channels



## MICO+ 4.6

4 channels

Order Data	Art-No.	Art-No.
1 A, 2 A, 3 A, 4 A	9000-41084-0100400	
1 A, 2 A, 4 A, 6 A		9000-41084-0100600
<b>Input</b>		
Operating voltage	24 V DC (18...30 V DC)	
<b>Output</b>		
Current adjustment	1 A, 2 A, 3 A, 4 A, by countersunk rotary switch, sealed	1 A, 2 A, 4 A, 6 A, by countersunk rotary switch, sealed
Inrush capacity	max. 20 mF (per channel)	
<b>Control inputs</b>		
Input voltage (ON)	10...30 V DC	
Remote start (OFF)	10...30 V DC	
Impulse length (ON)	min. 20 ms	
<b>Control outputs</b>		
Group alarm output	max. 20 mA; high: all channels ON; low: not all channels ON	
Early warning (90%)	max. 20 mA; high: one channel over 90%; low: all channels under 90%	
<b>General data</b>		
Connection	Spring clamp terminals	
Input terminals	2 × 16 mm <sup>2</sup>	
Output terminals	per output 2 × 1.5 mm <sup>2</sup>	
Alarm terminals	2.5 mm <sup>2</sup>	
Bridging concept	two sides, with spring clamp terminals or bridge set (max. 40 A)	
Mounting method	DIN-rail mountable TH35 (EN 60715)	
Temperature range	0...+55 °C (storage temperature -40...+80 °C)	
<b>Dimension drawing</b>		

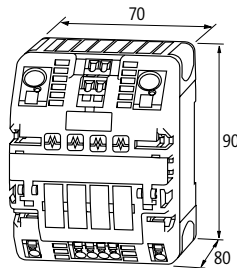

## Notes

## INTELLIGENT POWER DISTRIBUTION

### Over current protection device

- adjustable current ranges
- early warning (90%)

Approvals:   

### MICO+ 4.10

4 channels



Order Data		Art-No.
4 A, 6 A, 8 A, 10 A		9000-41084-0401000
<b>Input</b>		
Operating voltage	24 V DC (18...30 V DC)	
<b>Output</b>		
Current adjustment	4 A, 6 A, 8 A, 10 A, by countersunk rotary switch, sealed	
Inrush capacity	max. 20 mF (per channel)	
<b>Control inputs</b>		
Input voltage (ON)	10...30 V DC	
Remote start (OFF)	10...30 V DC	
Impulse length (ON)	min. 20 ms	
<b>Control outputs</b>		
Group alarm output	max. 20 mA; high: all channels ON; low: not all channels ON	
Early warning (90%)	max. 20 mA; high: one channel over 90%; low: all channels under 90%	
<b>General data</b>		
Connection	Spring clamp terminals	
Input terminals	2 × 16 mm <sup>2</sup>	
Output terminals	per output 2 × 1.5 mm <sup>2</sup>	
Alarm terminals	2.5 mm <sup>2</sup>	
Bridging concept	two sides, with spring clamp terminals or bridge set (max. 40 A)	
Mounting method	DIN-rail mountable TH35 (EN 60715)	
Temperature range	0...+55 °C (storage temperature -40...+80 °C)	
<b>Dimension drawing</b>		

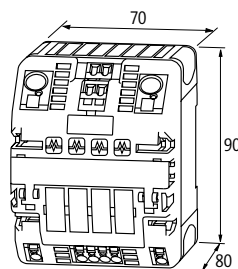

Notes

# INTELLIGENT POWER DISTRIBUTION

## Over current protection device



### MICO 4.4

4 channels



### MICO 2.4

2 channels



Order Data	Art-No.	Art-No.
1 A, 2 A, 3 A, 4 A	DNV-GL 9000-41034-0100400	cURus 9000-41042-0100400
<b>Input</b>	Operating voltage 24 V DC (18...30 V DC)	
<b>Output</b>	Current adjustment 1 A, 2 A, 3 A, 4 A, by countersunk rotary switch, sealed	
<b>Control inputs</b>	Inrush capacity max. 20 mF (per channel)	
<b>Control outputs</b>	Input voltage (ON) 10...30 V DC	
	Impulse length (ON) min. 20 ms	
<b>General data</b>	Group alarm output potential free 30 V AC/DC, 100 mA	
<b>Connection</b>	Spring clamp terminals	
Input terminals	2 × 16 mm <sup>2</sup>	1 × 16 mm <sup>2</sup>
Output terminals	per output 1 × 4 mm <sup>2</sup>	
Alarm terminals	2.5 mm <sup>2</sup>	
Bridging concept	two sides, with spring clamp terminals or bridge set (max. 40 A)	one side, with spring clamp terminals or bridge set (max. 40 A)
Mounting method	DIN-rail mountable TH35 (EN 60715)	
Temperature range	0...+55 °C (storage temperature -40...+80 °C)	

### Dimension drawing

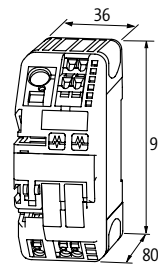
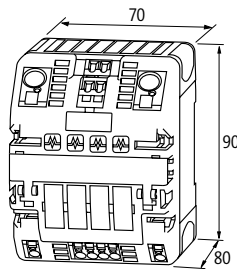

### Notes

# INTELLIGENT POWER DISTRIBUTION

## Over current protection device

### MICO 4.6

4 channels



### MICO 2.6

2 channels



Approvals:   

Order Data	Art-No.		Art-No.
1 A, 2 A, 4 A, 6 A	DNV-GL	9000-41034-0100600	cURus 9000-41042-0100600
<b>Input</b>			
Operating voltage	24 V DC (18...30 V DC)		
<b>Output</b>			
Current adjustment	1 A, 2 A, 4 A, 6 A, by countersunk rotary switch, sealed		
Inrush capacity	max. 20 mF (per channel)		
<b>Control inputs</b>			
Input voltage (ON)	10...30 V DC		
Impulse length (ON)	min. 20 ms		
<b>Control outputs</b>			
Group alarm output	potential free 30 V AC/DC, 100 mA		
<b>General data</b>			
Connection	Spring clamp terminals		
Input terminals	2 × 16 mm <sup>2</sup>	1 × 16 mm <sup>2</sup>	
Output terminals	per output 1 × 4 mm <sup>2</sup>		
Alarm terminals	2.5 mm <sup>2</sup>		
Bridging concept	two sides, with spring clamp terminals or bridge set (max. 40 A)	one side, with spring clamp terminals or bridge set (max. 40 A)	
Mounting method	DIN-rail mountable TH35 (EN 60715)		
Temperature range	0...+55 °C (storage temperature -40...+80 °C)		

### Dimension drawing

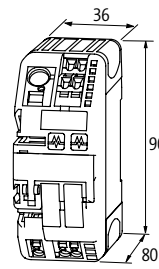
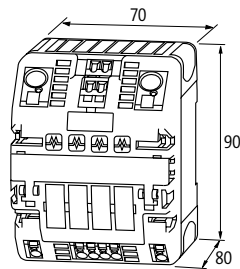

Notes

# INTELLIGENT POWER DISTRIBUTION

## Over current protection device

### MICO 4.10

4 channels



### MICO 2.10

2 channels



Approvals:   

Order Data	Art-No.	Art-No.
4 A, 6 A, 8 A, 10 A	DNV-GL 9000-41034-0401000	cURus 9000-41042-0401000
<b>Input</b>		
Operating voltage	24 V DC (18...30 V DC)	
<b>Output</b>		
Current adjustment	4 A, 6 A, 8 A, 10 A, by countersunk rotary switch, sealed	
Inrush capacity	max. 20 mF (per channel)	
<b>Control inputs</b>		
Input voltage (ON)	10...30 V DC	
Impulse length (ON)	min. 20 ms	
<b>Control outputs</b>		
Group alarm output	potential free 30 V AC/DC, 100 mA	
<b>General data</b>		
Connection	Spring clamp terminals	
Input terminals	2 × 16 mm <sup>2</sup>	1 × 16 mm <sup>2</sup>
Output terminals	per output 1 × 4 mm <sup>2</sup>	
Alarm terminals	2.5 mm <sup>2</sup>	
Bridging concept	two sides, with spring clamp terminals or bridge set (max. 40 A)	one side, with spring clamp terminals or bridge set (max. 40 A)
Mounting method	DIN-rail mountable TH35 (EN 60715)	
Temperature range	0...+55 °C (storage temperature -40...+80 °C)	

### Dimension drawing

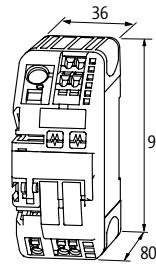
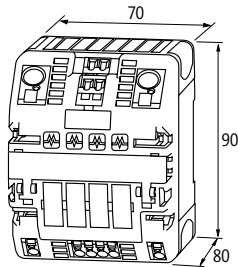

### Notes

# INTELLIGENT POWER DISTRIBUTION

## Over current protection device

## MICO 4.4.10 ACTUATOR-SENSOR

## MICO 4.10 SPEED START

4 channels  
optimized start-up behavior

Approvals:   



Order Data	Art-No.	Art-No.
1 A, 2 A, 3 A, 4 A; 4 A, 6 A, 8 A, 10 A	9000-41034-0101000	
4 A, 6 A, 8 A, 10 A		9000-41034-0401005
<b>Input</b>		
Operating voltage	24 V DC (18...30 V DC)	
<b>Output</b>		
Current adjustment	1 A, 2 A, 3 A, 4 A; 4 A, 6 A, 8 A, 10 A, by countersunk rotary switch, sealed	4 A, 6 A, 8 A, 10 A, by countersunk rotary switch, sealed
Inrush capacity	max. 20 mF (per channel)	max. 30 mF (per channel)
<b>Control inputs</b>		
Input voltage (ON)	10...30 V DC	
Impulse length (ON)	min. 20 ms	
<b>Control outputs</b>		
Group alarm output	potential free 30 V AC/DC, 100 mA	
<b>General data</b>		
Connection	Spring clamp terminals	
Input terminals	2 × 16 mm <sup>2</sup>	
Output terminals	per output 1 × 4 mm <sup>2</sup>	
Alarm terminals	2.5 mm <sup>2</sup>	
Bridging concept	two sides, with spring clamp terminals or bridge set (max. 40 A)	
Mounting method	DIN-rail mountable TH35 (EN 60715)	
Temperature range	0...+55 °C (storage temperature -40...+80 °C)	

## Dimension drawing

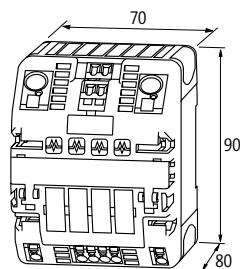

Notes



# INTELLIGENT POWER DISTRIBUTION

## Over current protection device

– preset current ranges

Approvals:     
Listed C US



### MICO BASIC 8.2

8 channels



### MICO BASIC 8.4

8 channels

### MICO BASIC 8.6

8 channels

Order Data	Art-No.	Art-No.	Art-No.
2 A	NEC Class 2 <b>9000-41068-0200000</b>		
4 A		NEC Class 2 <b>9000-41068-0400000</b>	
6 A			<b>9000-41068-0600000</b>
<b>Input</b>			
Operating voltage	24 V DC (18...30 V DC)		
<b>Output</b>			
Current adjustment	2 A	4 A	6 A
Inrush capacity	max. 20 mF (per channel)		
<b>Control inputs</b>			
Input voltage (ON)	10...30 V DC		
Impulse length (ON)	min. 20 ms		
<b>Control outputs</b>			
Group alarm output	max. 20 mA; high: all channels ON; low: not all channels ON		
<b>General data</b>			
Input terminals	1 × 16 mm <sup>2</sup>		
Output terminals	per output 1 × 4 mm <sup>2</sup>		
Alarm terminals	2.5 mm <sup>2</sup>		
Bridging concept	one side, with spring clamp terminals or bridge set (max. 40 A)		
Connection	Spring clamp terminals		
Mounting method	DIN-rail mountable TH35 (EN 60715)		
Temperature range	0...+55 °C (storage temperature -40...+80 °C)		
<b>Dimension drawing</b>			

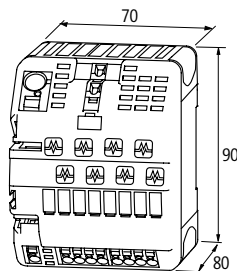

## Notes

# INTELLIGENT POWER DISTRIBUTION

Over current protection device

– preset current ranges

Approvals:   



**MICO BASIC 4.2**

4 channels



**MICO BASIC 4.4**

4 channels

**MICO BASIC 4.6**

4 channels

Order Data	Art-No.		Art-No.		Art-No.
2 A	NEC Class 2	<b>9000-41064-0200000</b>			
4 A			NEC Class 2	<b>9000-41064-0400000</b>	
6 A					<b>9000-41064-0600000</b>
<b>Input</b>					
Operating voltage	24 V DC (18...30 V DC)				
<b>Output</b>					
Current adjustment	2 A		4 A		6 A
Inrush capacity	max. 20 mF (per channel)				
<b>Control inputs</b>					
Input voltage (ON)	10...30 V DC				
Impulse length (ON)	min. 20 ms				
<b>Control outputs</b>					
Group alarm output	max. 20 mA; high: all channels ON; low: not all channels ON				
<b>General data</b>					
Connection	Spring clamp terminals				
Input terminals	1 × 16 mm <sup>2</sup>				
Output terminals	per output 1 × 4 mm <sup>2</sup>				
Alarm terminals	2.5 mm <sup>2</sup>				
Bridging concept	one side, with spring clamp terminals or bridge set (max. 40 A)				
Mounting method	DIN-rail mountable TH35 (EN 60715)				
Temperature range	0...+55 °C (storage temperature -40...+80 °C)				
<b>Dimension drawing</b>					

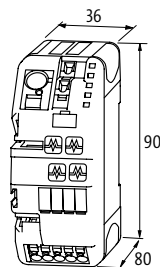

Notes

# INTELLIGENT POWER DISTRIBUTION

## Over current protection device

– preset current ranges

### MICO BASIC 5.2/3.6

8 channels



Approvals:  Class 2   US

Order Data		Art-No.
5 × 2 A; 3 × 6 A		9000-41068-0200600
Input		
Operating voltage	24 V DC (18...30 V DC)	
Output		
Current adjustment	5 × 2 A; 3 × 6 A	
Inrush capacity	max. 20 mF (per channel)	
Control inputs		
Input voltage (ON)	10...30 V DC	
Impulse length (ON)	min. 20 ms	
Control outputs		
Group alarm output	max. 20 mA; high: all channels ON; low: not all channels ON	
General data		
Connection	Spring clamp terminals	
Input terminals	1 × 16 mm <sup>2</sup>	
Output terminals	per output 1 × 4 mm <sup>2</sup>	
Alarm terminals	2.5 mm <sup>2</sup>	
Bridging concept	one side, with spring clamp terminals or bridge set (max. 40 A)	
Mounting method	DIN-rail mountable TH35 (EN 60715)	
Temperature range	0...+55 °C (storage temperature -40...+80 °C)	
Dimension drawing		

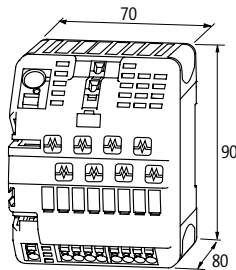

## Notes

Intelligent Power Distribution

# INTELLIGENT POWER DISTRIBUTION

Socket for glass tube fuses

**MICO FUSE 24 LED**

8 channels



**MICO FUSE 250**

8 channels







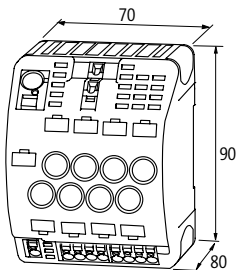

Approvals: **UL** **CSA**

Order Data	Art-No.	Art-No.
24 V DC	9000-41078-0600001	
max. 250 V AC/DC		9000-41078-0600002
Technical Data		
Operating voltage	24 V DC (18...30 V DC)	max. 250 V AC/DC
Operating current	max. 6 A (40 °C)	
Total current	max. 40 A	
Control outputs		
Group alarm output	max. 20 mA; high: all channels ON; low: not all channels ON	-
General data		
Connection	Spring clamp terminals	
Input terminals	1 × 16 mm <sup>2</sup>	
Output terminals	1 × 0.5...4 mm <sup>2</sup>	
Alarm terminals	2.5 mm <sup>2</sup>	-
Mounting method	DIN-rail mountable TH35 (EN 60715)	
Temperature range	-25...+55 °C	
Dimension drawing		



Notes

## INTELLIGENT POWER DISTRIBUTION

Accessories			Art-No.
	<b>Bridge system</b>	Quantity: 1 piece	9000-41034-0000002
		Quantity: 10 pcs.	9000-41034-0000001
	<b>Shortened buttons</b>	Quantity: 4 pcs.	9000-41034-0000003
	<b>Label plates</b>		
	KES 20 × 8 (white)	(10 pieces/2 plates)	996067
	KMR 5 × 10 (white) MICO BASIC, MICO FUSE, Mico Pro®	(64 pieces/4 plates)	996078
	<b>Glass automotive fuse</b>		
	2 A (T)		9000-41078-0000002
	4 A (T)		9000-41078-0000004
	<b>Fuse cap</b>	Quantity: 8 pcs.	9000-41078-0000010
Accessories Mico Pro®			Art-No.
	<b>Plug-In-Link 2 × blue</b>		
	Length: 500 mm		9000-41000-0000000
	<b>Plug-In-Link 2 × red</b>		
	Length: 500 mm		9000-41000-0000001
	<b>Plug-In-Link 1 × blue, 1 × red</b>		
	Length: 500 mm		9000-41000-0000002
	<b>Cover plate</b>		
	1 Set (left/right)		9000-41000-0000006



# CONVERTERS / RECTIFIERS

- Compact design
- Galvanic separation
- Switch mode models

## SMALL VOLTAGE CONVERTERS

Voltages in control systems often have to be converted. The DC/DC converters in the MDD series do this perfectly! It doesn't matter if you need 5, 10, 12 or 24 volts – Murrelektronik has the right product.

If there is only AC voltage available, the NG rectifier series can convert into DC voltage. All models can be conveniently mounted in the control cabinet on DIN rail.

## AC/DC and DC/DC Converters



MDD, GLS, GSS, NG, NT

- Output current range: 0.5...4A

*Page 1.5.1*

## Rectifiers



NG

- Output current range: 2.6...10A

*Page 1.5.3*

# CONVERTERS / RECTIFIERS

Switched mode

– with galvanic isolation

**MDD**

OUTPUT: 24 V DC  
Current: 0.3 A



**MDD**

OUTPUT: 12 V DC  
Current: 0.7 A

**MDD**

OUTPUT: 5 V DC  
Current: 1.5 A



**MDD**

OUTPUT: ±10 V DC  
Current: 2 × 0.25 A



**MDD**

OUTPUT: ±15 V DC  
Current: 2 × 0.25 A

## Circuit diagram

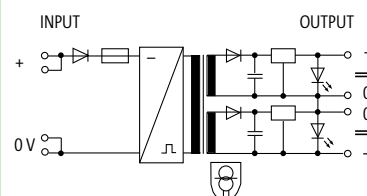
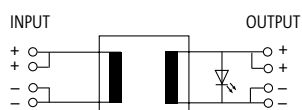

Order Data	Art-No.	Art-No.	Art-No.	Art-No.	Art-No.
24 V DC/0.3 A	85655				
12 V DC/0.7 A		85656			
5 V DC/1.5 A			85657		
±10 V DC/2 × 250 mA				85658	
±15 V DC/2 × 250 mA					85659

Input	
Input voltage	24 V DC
Input current	0.6 A      0.85 A
Input fuse (external)	2 A (T)      -
Input fuse (internal)	1.5 A (T)

Output	
Output fuse	short-circuit and overload protected, restart after overload by removing power supply
Output voltage	24 V DC (SELV), ±2%      12 V DC (SELV), ±2%      5 V DC (SELV), ±2%      ±10 V DC (SELV), ±5%      ±15 V DC (SELV), ±5%
Output current	max. 0.3 A      max. 0.7 A      max. 1.5 A      max. 2 × 250 mA
Ripple	max. 0.2 %rms

General data	
Standards	EN 61204-3
Test isolation voltage	4 kV (input/output)
Mounting method	DIN-rail mountable TH35 or G32 (EN 60715)
Temperature range	0...+50 °C, no condensation

## Dimension drawing

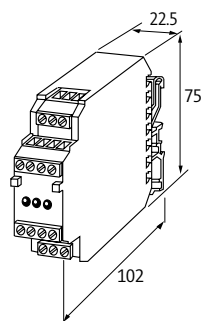

## Notes

# CONVERTERS / RECTIFIERS

DC/DC converters

AC/DC converters

**GLS**

OUTPUT regulated: 5 V DC  
Current: 1.2 A



**GSS**

OUTPUT switched mode: 5 V DC  
Current: 4 A



**NT**

OUTPUT: 5...35 V DC  
Current: 3.5 A



Circuit diagram

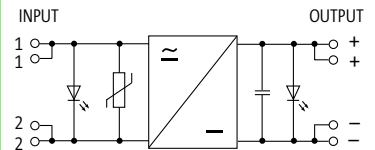
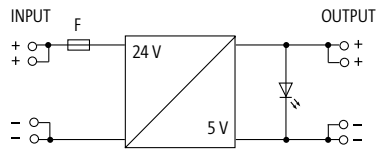

Order Data	Art-No.	Art-No.	Art-No.
5 V DC/1.2 A	85600		
5 V DC/4 A		85650	
5...35 V DC/3.5 A			85660
<b>Input</b>			
Input voltage	24 V DC (+10 -15%)	15...40 V DC	10...32 V AC/12...42 V DC
Input current	1.2 A	1.04 A (24 V DC); max. 1.7 A	max. 3 A
Input fuse (internal)	2 A (T)		6.3 A (T)
Frequency	-		50...60 Hz
<b>Output</b>			
Output voltage	5 V DC (SELV), ±5%		5...35 V DC (SELV), Uout-max. = Uin - 5 V
Output current	max. 1.2 A	max. 4 A	max. 3.5 A
Ripple	max. 0.2 %rms		max. 300 mVrms
Output fuse	short-circuit protected		
<b>General data</b>			
Mounting method	DIN-rail mountable TH35 (EN 60715)		
Temperature range	-20...+60 °C, no condensation		
<b>Dimension drawing</b>			

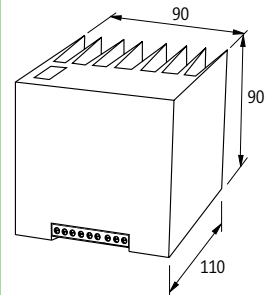
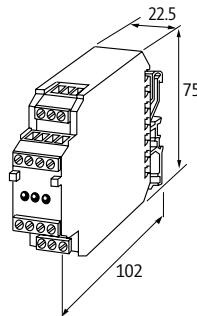
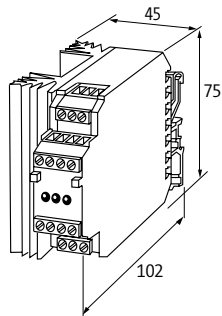

Notes



# CONVERTERS / RECTIFIERS

## Rectifier modules

– Single-phase

– IP00

### NG 2

INPUT: max. 41 V AC



### NG 5

INPUT: max. 41 V AC

### NG 10

INPUT: 29 V AC



## Circuit diagram

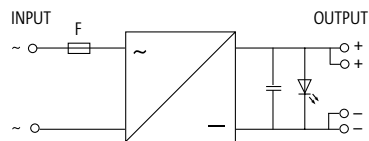

Order Data	H×W×D	Art-No.	H×W×D	Art-No.	H×W×D	Art-No.
24 V DC/2.6 A	86×45×92 mm	85700				
24 V DC/5 A			90×68×87 mm	85710		
24 V DC/10 A						85730
<b>Input</b>						
Input voltage	max. 5...44 V AC			29 V AC		
Input current	max. 2.6 A; 1.8 A (+60 °C)		max. 5 A; 4 A (+60 °C)		max. 10 A	
Frequency	45...65 Hz			50...60 Hz (or as additional smoothing for DC)		
Input fuse (external)	–		8 A (T), 5 × 20 mm		16 A (T), 5 × 20 mm	
Input fuse (internal)	3.15 A (T), 5 × 20 mm		–			
<b>Output</b>						
Output voltage	U-IN × 1.16/max. 60 V DC			U-IN × 1.16/39 V DC		
Output current	max. 2.6 A; 1.8 A (+60 °C)		max. 5 A; 4 A (+60 °C)		max. 10 A	
Ripple	max. 5 %rms					
Output filter	smoothed with smoothing capacitor and LED					
<b>General data</b>						
Mounting method	DIN-rail mountable TH35 (EN 60715)					
Temperature range	-20...+60 °C					
<b>Dimension drawing</b>						

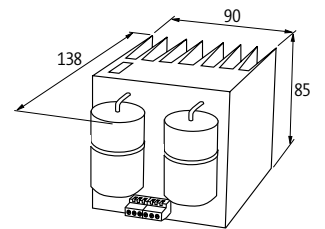
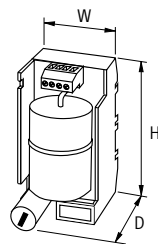

## Notes



# MODLINK MSVD – CONTROL CABINET POWER OUTLETS

- Safe
- Easy to install
- Meet international standards

## KEEP IT SAFE – EVEN IN THE CONTROL CABINETS

Using components temporarily in the control cabinet require right power outlets. Murrelektronik has the right tools: a wide range of power outlets for different countries.

### Control Cabinet Power Outlets



#### German standard (VDE)

- For DIN-rail mounting acc. to EN 60715
- With screw terminals or spring clamp terminals

*An overview of this product range can be found in our online shop*



#### French standard (UTE)

- For DIN-rail mounting acc. to EN 60715
- With screw terminals or spring clamp terminals

*An overview of this product range can be found in our online shop*



#### American standard (NEMA 5-15)

- For DIN-rail mounting acc. to EN 60715
- With screw terminals
- LED display

*An overview of this product range can be found in our online shop*



#### Different international standards

- For DIN-rail mounting acc. to EN 60715

*An overview of this product range can be found in our online shop*



# EMC FILTERS FOR MAXIMUM SAFETY

- Meets EMC guidelines
- Increases interference protection
- Decreases interference emissions

## KEEP IT SAFE – EVEN IN THE CONTROL CABINETS

**Mains filters are used to reduce interference without affecting the supply.** Murrelektronik's filters decrease incoming interference, which can affect sensitive equipment, and also decrease outgoing interference from the equipment they are connected to, which could damage the mains supply. Typical sources of continuous interference are switch mode power supplies, motors and phase controllers.

These sources are made up of inductive and capacitive components and work the best when their impedance is matched to the source of the interference. In regards to grounding, it's important to have a low impedance. Ideally, the filter should be as close as possible to the point where the cable enters the cabinet. If that's not possible, then shielded cables should be used between the filter and the entry point. Ground straps should be as short as possible and connection surfaces should be free from paint, etc.

### Single-phase



#### MEF Emparro® 1/1 – one-stage

- Operating voltage: max. 265 V AC/DC
- Nominal current: 20 A

Page 1.7.1



#### MEF 1/2 SY and MEF 1/2 AS – two-stage

- Operating voltage: max. 250 V AC/DC, 0...60 Hz
- Nominal current: 10...16 A

Page 1.7.2

### Three-phase



#### MEF 3/1 N – one-stage

- Operating voltage: max. 3 × 440 V AC
- Nominal current: 3...20 A

Page 1.7.5



#### MEF 3/1 N HD – one-stage

- Operating voltage: max. 3 × 500 V AC
- Nominal current: 10...135 A

Page 1.7.6



#### MEF 3/1 and MEF 3/2 – one and two-stage

- Operating voltage: max. 3 × 500 V AC / 3 × 600 V AC
- Nominal current: 8...180 A

Page 1.7.7

## EMC FILTERS

1-phase, 1-stage

– DIN-rail mountable

Approvals:  **ULus**

**MEF Emparro® 1/1**  
wide attenuation spectrum



### Circuit diagram

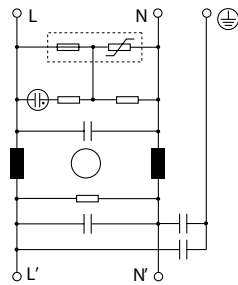

### Order Data

20 A Art-No. 10701

### Technical Data

Operating voltage	85...265 V AC/100...230 V DC
Operating frequency	50...60 Hz
Consumption	max. 1 mA (250 V AC)
Connection cross section	1.5...10 mm <sup>2</sup> single core (AWG 16...8); 1.5...6 mm <sup>2</sup> multiple core (AWG 16...10)

### General data

Climatic category	Environment class (EN 60721)
Connection	Push In terminals
Mounting method	DIN-rail mountable TH35 (EN 60715)

### Dimension drawing

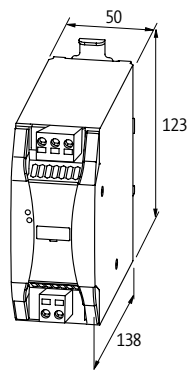

### Notes

# EMC FILTERS

1-phase, 1-stage

– DIN-rail mountable

Approvals: 

## MEF 1/1

for universal applications



### Circuit diagram

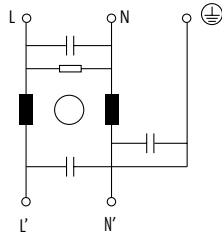

Order Data	Art-No.
10 A	10415
20 A	10416

Technical Data	
Operating voltage	max. 250 V AC/300 V DC
Operating frequency	50...60 Hz
Consumption	max. 5 mA (250 V AC)
Overload current	18 × (IN t) max. 0.5 ms; 1.5 × (IN t) max. 1 min. (1 × per hour)
Connection cross section	0.2...6 mm <sup>2</sup> single core (AWG 24...9); 0.2...4 mm <sup>2</sup> multiple core (AWG 24...11)

General data	
Climatic category	25/085/21 (EN 60068-1)
Test isolation voltage	2.7 kV (L - N), 2 s; 2.1 kV (L - L), 2 s (EN 60939-2)
Connection	Screw connection, touch protected
Mounting method	DIN-rail mountable TH35 (EN 60715)

### Dimension drawing

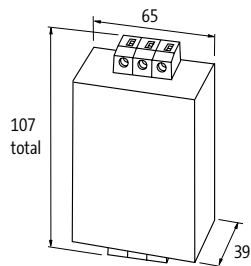

### Notes

# EMC FILTERS

1-phase, 2-stage

– DIN-rail mountable

Approvals:  **UL** <sub>US</sub>

## MEF 1/2 SY

against symmetrical interferences



### Circuit diagram

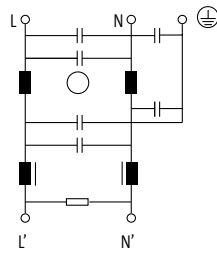

### Order Data

	Art-No.
1 A	10460
2 A	10461
3 A	10462
4 A	10463
6 A	10464
16 A	10466

### Technical Data

Operating voltage	max. 250 V AC/300 V DC
Operating frequency	50...60 Hz
Overload current	18 × (IN t) max. 0.5 ms; 1.5 × (IN t) max. 1 min. (1 × per hour)
Consumption	max. 5 mA (250 V AC)
Connection cross section	0.2...6 mm <sup>2</sup> single core (AWG 24...9); 0.2...4 mm <sup>2</sup> multiple core (AWG 24...11)

### General data

Climatic category	25/085/21 (EN 60068-1)
Test isolation voltage	2.7 kV (L - N), 2 s; 2.1 kV (L - L), 2 s (EN 60939-2)
Connection	Screw connection, touch protected
Mounting method	DIN-rail mountable TH35 (EN 60715)

### Description

Functional description  
The single phase 2-stage EMC filters MEF 1/2 are used in the range 0.1...30 MHz to suppress cable carried interference on mains and control cables. The best filter performance is achieved by using short connection wires (suggestion: earth connection < 10 cm) and the largest possible diameter. The EMC filters work bi-directionally (in both directions). The filters are for demanding applications. The filters are designed for use with fixed modules. One step of the filter is always for the suppression of asymmetrical interferences (magnetically compensated suppression). The second step is, dependant on application for symmetrical or asymmetrical interferences.

Application  
symmetrical interferences: units with high repetitions of the switching processes, - switch mode P.S.U.s, - phase angle controller, - supply of universal motors, - behind transformers

### Dimension drawing

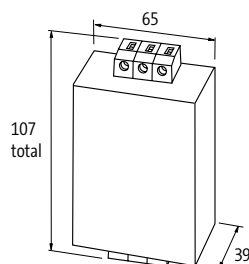

### Notes

# EMC FILTERS

1-phase, 2-stage

- DIN-rail mountable

Approvals: 

## MEF 1/2 AS

against asymmetrical interferences



### Circuit diagram

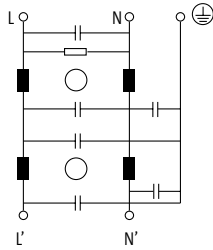

Order Data	Art-No.
3 A	10470
6 A	10471
10 A	10472

Technical Data	
Operating voltage	max. 250 V AC/300 V DC
Operating frequency	50...60 Hz
Consumption	max. 5 mA (250 V AC)
Overload current	18 × (IN t) max. 0.5 ms; 1.5 × (IN t) max. 1 min. (1 × per hour)
Connection cross section	0.2...6 mm <sup>2</sup> single core (AWG 24...9); 0.2...4 mm <sup>2</sup> multiple core (AWG 24...11)

General data	
Climatic category	25/085/21 (EN 60068-1)
Test isolation voltage	2.7 kV (L - N), 2 s; 2.1 kV (L - L), 2 s (EN 60939-2)
Connection	Screw connection, touch protected
Mounting method	DIN-rail mountable TH35 (EN 60715)

Description	
Functional description	The single phase 2-stage EMC filters MEF 1/2 are used in the range 0.1...30 MHz to suppress cable carried interference on mains and control cables. The best filter performance is achieved by using short connection wires (suggestion: earth connection < 10 cm) and the largest possible diameter. The EMC filters work bi-directionally (in both directions). The filters are for demanding applications. The filters are designed for use with fixed modules. One step of the filter is always for the suppression of asymmetrical interferences (magnetically compensated suppression). The second step is, dependant on application for symmetrical or asymmetrical interferences.

Application	asymmetrical interferences: - units with high switching frequency and repetition, - switch mode P.S.U.s, - in DC mains, - in front of transformers, - for frequency inverters
-------------	---

### Dimension drawing

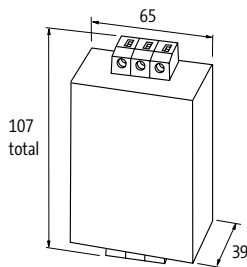

### Notes

## EMC FILTERS

3-phase, 1-stage

– DIN-rail mountable

– with neutral

Approvals: 

### MEF 3/1 N

for universal applications



#### Circuit diagram

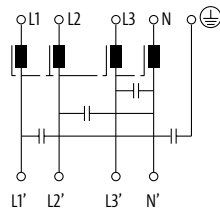

#### Order Data

	Art-No.
3 A	10510
6 A	10511
10 A	10512
20 A	10513

#### Technical Data

Operating voltage	max. 4 × 440 V AC
Operating frequency	50...60 Hz
Consumption	max. 3 mA (250 V AC)
Overload current	18 × (IN t) max. 0.5 ms; 1.5 × (IN t) max. 1 min. (1 × per hour)
Connection cross section	0.2...6 mm <sup>2</sup> single core (AWG 24...9); 0.2...4 mm <sup>2</sup> multiple core (AWG 24...11)

#### General data

Climatic category	25/085/21 (EN 60068-1)
Test isolation voltage	2.7 kV (L - N), 2 s; 2.1 kV (L - L), 2 s (EN 60939-2)
Connection	Screw connection, touch protected
Mounting method	DIN-rail mountable TH35 (EN 60715)

#### Description

Functional description  
The 3-phase and one-stage EMC filters MEF 3/1 are used in the range 0.1...30 MHz and dampen interferences found in cables from the mains, supply units and control systems. They are suitable for TN-S, TN-CS, and TT networks. The best results are obtained with short connection cables (suggestion: earth connection < 10 cm) of the largest possible cross-section. The EMC filters are bi-directional. They reduce symmetrical and asymmetrical interferences that regularly appear with electronically controlled three phase units through mains influences.

#### Dimension drawing

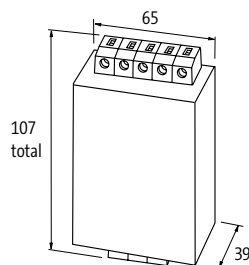

#### Notes



# EMC FILTERS

3-phase, 1-stage

– with neutral

Approvals: 

## MEF 3/1 N HD

with increased damping



### Circuit diagram

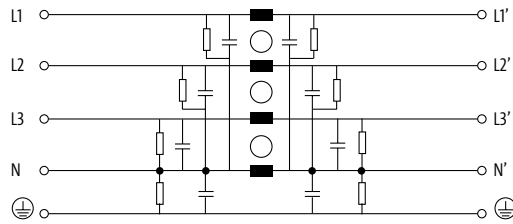

Order Data	H×W×D/kg	Art-No.
10 A	153×130×100/1.0	10571
18 A	153×130×100/1.0	10572
36 A	153×130×100/1.1	10574
72 A	153×118×125/1.6	10575
100 A	170×180×140/3.4	10577
135 A	170×180×140/4.5	10578

### Technical Data

Connection cross section	0.2...10 mm <sup>2</sup> single core (AWG 24...7); 0.2...6 mm <sup>2</sup> multiple core (AWG 24...9)
Operating voltage	max. 3 × 500 V AC
Operating frequency	50...60 Hz
Consumption	max. 15 mA (250 V AC)
Overload current	18 × (I <sub>N</sub> t) max. 0.5 ms; 1.5 × (I <sub>N</sub> t) max. 1 min. (1 × per hour)

### General data

Mounting method	screw fixing, M6
Climatic category	25/085/21 (EN 60068-1)
Test isolation voltage	3.3 kV (L - N), 2 s; 3.1 kV (L - L), 2 s

### Description

Functional description  
The 3-phase and one-stage EMC filters MEF 3/1 are used in the range 0.1...30 MHz and dampen interferences found in cables from the mains, supply units and control systems. They are suitable for TN-S, TN-CS, and TT networks. The best results are obtained with short connection cables (suggestion: earth connection < 10 cm) of the largest possible cross-section. The EMC filters are bi-directional. They reduce symmetrical and asymmetrical interferences that regularly appear with electronically controlled three phase units through mains influences.

### Dimension drawing

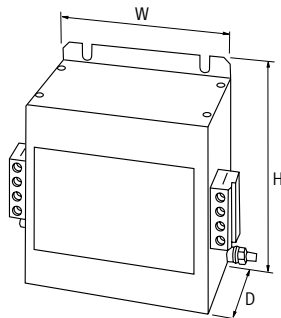

### Notes

# EMC FILTERS

3-phase, 1-stage

– Space saving book form

MEF 3/1



Approvals:

## Circuit diagram

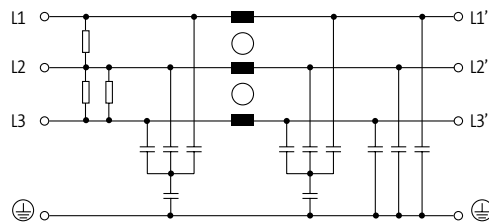

Order Data	HxWxD/kg	Art-No.
8 A	250x90x100/1.3	10531
16 A	250x90x100/1.3	10532
25 A	250x90x100/1.3	10533
36 A	250x90x100/1.5	10534
50 A	250x90x100/1.7	10535
80 A	270x85x135/2.2	10537
110 A	270x90x150/3.2	10538
180 A	380x120x170/5.1	10539

## Technical Data

Operating voltage	max. 3 x 600 V AC
Operating frequency	50...60 Hz
Overload current	18 x (IN t) max. 0.5 ms; 1.5 x (IN t) max. 1 min. (1 x per hour)
Consumption	max. 10 mA (250 V AC)
Connection cross section	0.2...10 mm <sup>2</sup> single core (AWG 24...7); 0.2...6 mm <sup>2</sup> multiple core (AWG 24...9)

## General data

Climatic category	25/085/21 (EN 60068-1)
Test isolation voltage	3.3 kV (L - N), 2 s; 3.1 kV (L - L), 2 s
Connection	Screw connection, touch protected
Mounting method	screw fixing

## Description

Functional description	The 3-phase and 1-/2-stage EMC filters MEF 3/1-3/2 are used in the range 0.1...30 MHz and dampen interferences found in cables from the mains, supply units and control systems. They are suitable for TN-C-mains. The best results are obtained with short connection cables (suggestion: earth connection < 10 cm) of the largest possible cross-section. The EMC filters are bi-directional. They reduce symmetrical and asymmetrical interferences that often occur with frequency converters and switch mode power supplies.
------------------------	---

## Dimension drawing

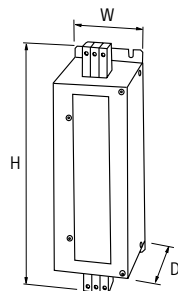

## Notes

# EMC FILTERS

3-phase, 2-stage

– Space saving book form

Approvals: 

MEF 3/2



## Circuit diagram

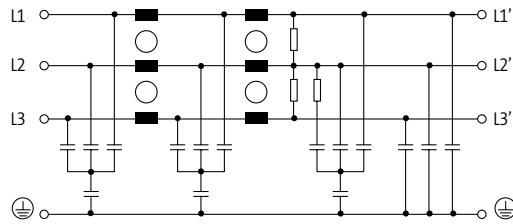

Order Data	HxWxD/kg	Art-No.
8 A	226x50x140/1.7	10550
12 A	226x50x140/1.7	10551
16 A	226x50x140/1.7	10552
25 A	226x50x140/1.7	10553
36 A	226x50x140/1.7	10554
50 A	295x70x177/3.7	10555
80 A	295x70x177/5.1	10556

## Technical Data

Operating voltage	max. 3 × 500 V AC
Operating frequency	50..60 Hz
Overload current	18 × (IN t) max. 0.5 ms; 1.5 × (IN t) max. 1 min. (1 × per hour)
Consumption	max. 15 mA (250 V AC)
Connection cross section	0.2...10 mm <sup>2</sup> single core (AWG 24...7); 0.2...6 mm <sup>2</sup> multiple core (AWG 24...9)

## General data

Climatic category	25/085/21 (EN 60068-1)
Test isolation voltage	3.3 kV (L - N), 2 s; 3.1 kV (L - L), 2 s
Connection	Screw connection, touch protected
Mounting method	screw fixing

## Description

Functional description  
The 3-phase and 1-1/2-stage EMC filters MEF 3/1-3/2 are used in the range 0.1...30 MHz and dampen interferences found in cables from the mains, supply units and control systems. They are suitable for TN-C-mains. The best results are obtained with short connection cables (suggestion: earth connection < 10 cm) of the largest possible cross-section. The EMC filters are bi-directional. They reduce symmetrical and asymmetrical interferences that often occur with frequency converters and switch mode power supplies.

## Dimension drawing

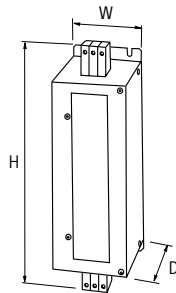

## Notes



# EMC SUPPRESSORS

## SMALL DEVICE, BIG IMPACT

- Meets EMC guidelines
- Reduces voltage peaks
- Prevents coil short circuits

### MURRELEKTRONIK SOLVES YOUR INTERFERENCE PROBLEMS

- Optimum interference results by adjusting your inductive load
- Prefabricated modules make it easy to install – reliably mounted every time
- Prevents operative failures and outages and increases availability
- Long service life of contacts and switching elements lower maintenance costs

### THE RIGHT SUPPRESSION FOR ALL STANDARD INDUCTIVE LOADS

#### For Contactors

- Integrated system solutions for all standard contactors
- Universal suppressors for contactors or relays that snap in or stick to the mounting surface

#### For Motors

- Suppression directly next to the interference source or inside the motor terminal box
- Motor connector has 10 poles and an earth connection point with integrated suppressor module and pre-wired cable
- Integrated system solutions for direct connection to the contactor
- Universal suppressors snap in next to the motor contactor

#### For Valves

- Suppressors are simply mounted between valve base and valve plug instead of the flat gasket

## EMC Suppressors

 <p><b>For Contactors</b> ABB, General Electric, Eaton, Omron, Rockwell A. B., Schneider-Telemecanique, Siemens</p> <p><b>Universal Suppressors</b></p> <p style="text-align: right;"><i>Page 1.8.1</i></p>	 <p><b>For Motors – Installation on the Motor</b> RC 3 U, RC 3 R, RC 3 ST</p> <p style="text-align: right;"><i>Page 1.8.12</i></p>
 <p><b>For Motors – Installation in the Cabinet</b> RC 3 BUR, HRC 3 AS, RC 3 RT</p> <p style="text-align: right;"><i>Page 1.8.15</i></p>	 <p><b>For Valves</b> Form A, B, BI, C, CI</p> <p style="text-align: right;"><i>Page 1.8.17</i></p>

# EMC SUPPRESSORS

## Suppressors for contactors



BC



A 16



A 110

Approvals:

### Circuit diagram

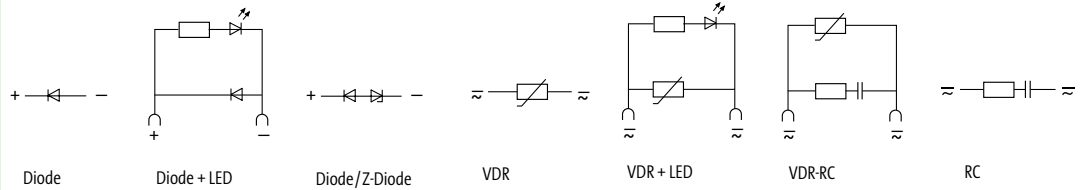

### Appropriate contactors

B 6, BC 6, VB 6, KC 6

A 9...A 16

A 26...A 110

### Order Data

Voltage	Suppression	Approval	Art.-No.	Art.-No.	Art.-No.
24...240 V DC	Diode			<b>26440</b>	
24 V DC	Diode + LED				
	Diode/Z-Diode				
24 V AC/DC	VDR	CSA	<b>26277</b>		
	VDR + LED				
	RC				
48 V DC	Diode/Z-Diode				
48 V AC/DC	VDR	CSA	<b>26278</b>		
	RC				
110 V AC/DC	VDR				
	VDR + LED				
	VDR-RC				
	RC				
230 V AC/DC	VDR	CSA	<b>26079</b>	CSA	<b>21172</b>
	VDR + LED				
	VDR-RC				
	VDR-RC + LED				
	RC				
400 V AC/DC	VDR				
	RC				
415 V AC/DC	RC				

### Technical Data

Damping factor	$\sim 1.5 \times U_N$
Temperature range	-20...+70 °C
Material	plastic, flame retardant (UL 94)
Connection wires	self-securing cable forks      plug contact

### Dimension drawing

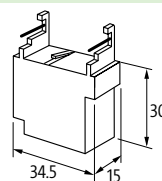
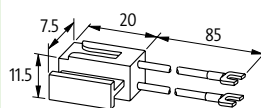

### Notes

# EMC SUPPRESSORS

## Suppressors for contactors



Approvals:

M



CL



### Circuit diagram

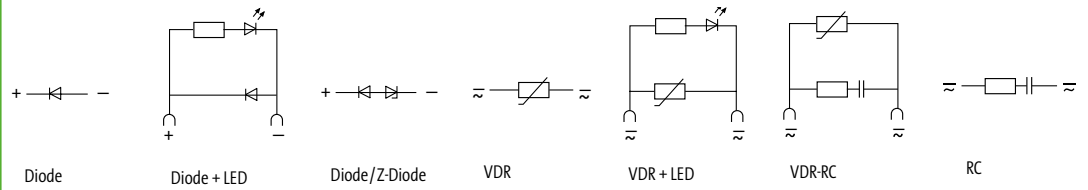

### Appropriate contactors

M	CL00, 01, 02, 25	CL03, 04, 45	CL05...10
---	------------------	--------------	-----------

### Order Data

Voltage	Suppression	Art.-No.	Art.-No.	Art.-No.	Art.-No.
24...240 V DC	Diode	2000-68300-1100000	2000-69100-1100000	2000-69200-1100000	
24 V DC	Diode + LED				
	Diode/Z-Diode				
24 V AC/DC	VDR	2000-68300-4400000	2000-69100-4400000	2000-69200-4400000	2000-69100-4400000
	VDR + LED				
	RC	2000-68300-4300000	2000-69100-4300000	2000-69200-4300000	2000-69101-4300000
48 V DC	Diode/Z-Diode				
48 V AC/DC	VDR	2000-68300-4400000	2000-69100-4400000	2000-69200-4400000	2000-69100-4400000
	RC	2000-68300-4300000	2000-69100-4300000	2000-69200-4300000	2000-69101-4300000
110 V AC/DC	VDR		2000-69100-7400000	2000-69200-7400000	2000-69100-7400000
	VDR + LED				
	VDR-RC				
	RC		2000-69100-7300000		
230 V AC/DC	VDR		2000-69100-2420000	2000-69200-2420000	
	VDR + LED				
	VDR-RC				
	VDR-RC + LED				
	RC			2000-69200-2320000	2000-69101-2320000
400 V AC/DC	VDR		2000-69100-5420000	2000-69200-5420000	2000-69100-5420000
	RC				
415 V AC/DC	RC				

### Technical Data

Damping factor	$\sim 1.5 \times U_N$
Temperature range	-20...+70 °C
Material	plastic, flame retardant (UL 94)
Connection wires	plug contact

### Dimension drawing

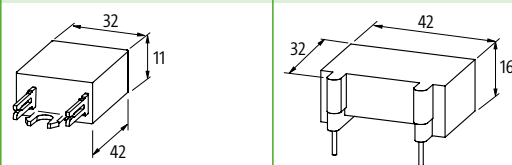

### Notes

Art.-No. 2000-69200-1100000 – also for CL05...10 DC-coils.

# EMC SUPPRESSORS

## Suppressors for contactors



Approvals:



## X-Start



### Circuit diagram

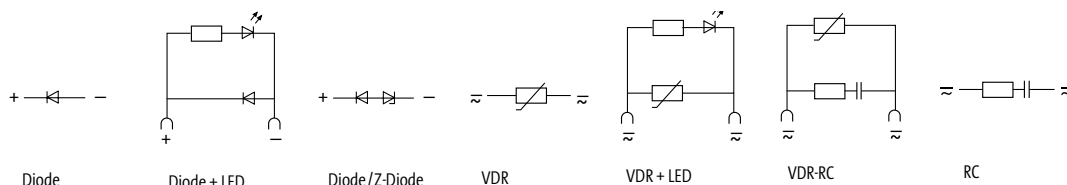

### Appropriate contactors

DIL M7...15 DIL MP20, DIL A	DIL M17...32	DIL M40...95
--------------------------------	--------------	--------------

### Order Data

Voltage	Suppression	Art.-No.	Art.-No.	Art.-No.
24...240 V DC	Diode			
24 V DC	Diode + LED			
	Diode/Z-Diode			
24 V AC/DC	VDR			
	VDR + LED	26013	26015	
	RC			
48 V DC	Diode/Z-Diode			
48 V AC	VDR + LED	26013	26015	
	RC			
110 V AC/DC	VDR			
	VDR + LED	26014		
	VDR-RC			
	RC	20007	20008	20009
230 V AC/DC	VDR			
	VDR + LED	26014		
	VDR-RC			
	VDR-RC + LED			
	RC	20007	20008	20009
400 V AC/DC	VDR			
	RC			

### Technical Data

Damping factor	$\sim 1.5 \times U_N$
Temperature range	-20...+70 °C
Material	plastic, flame retardant (UL 94)
Connection wires	plug contact

### Dimension drawing

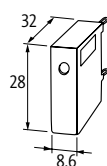

### Notes

LED indicator for 24 V DC without suppression available on request.

# EMC SUPPRESSORS

## Suppressors for contactors



Approvals:

DIL E



### Circuit diagram

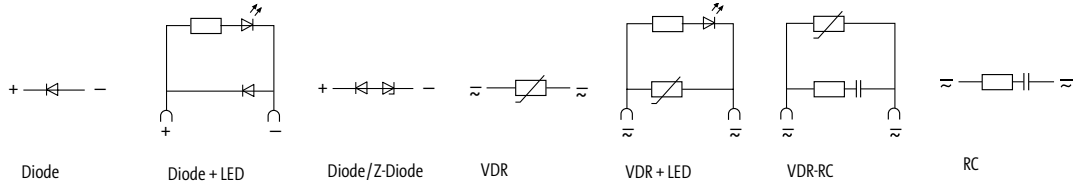

### Appropriate contactors

DIL E...

### Order Data

Art.-No.

Voltage	Suppression	Art.-No.
24...240 V DC	Diode	
24 V DC	Diode + LED	
	Diode/Z-Diode	
24 V AC/DC	VDR	
	VDR + LED	
	RC	
48 V DC	Diode/Z-Diode	
48 V AC/DC	VDR	
	RC	
110 V AC/DC	VDR	
	VDR + LED	
	VDR-RC	
	RC	<b>21054</b>
230 V AC/DC	VDR	<b>26086</b>
	VDR + LED	
	VDR-RC	
	VDR-RC + LED	
	RC	<b>21054</b>
400 V AC/DC	VDR	
	RC	

### Technical Data

Damping factor	$\sim 1.5 \times U_N$
Temperature range	-20...+70 °C
Material	plastic, flame retardant (UL 94)
Connection wires	self-securing cable forks

### Dimension drawing

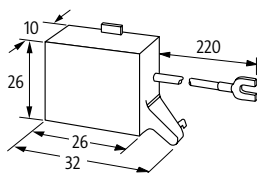

### Notes



# EMC SUPPRESSORS

Suppressors for contactors

**OMRON**

J7KNA



J7KN



J7KN



**Circuit diagram**

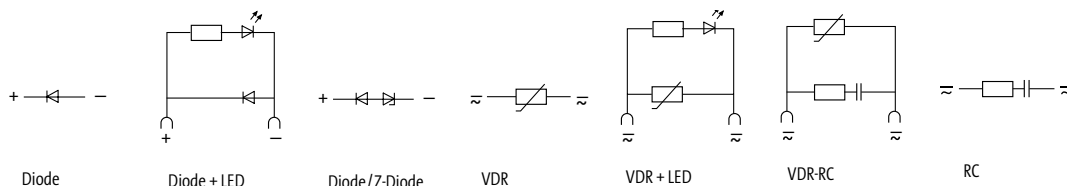

**Appropriate contactors**

J7KNA

J7KN

J7KN

**Order Data**

**Art.-No.**

**Art.-No.**

**Art.-No.**

Voltage	Suppression	Art.-No.	Art.-No.	Art.-No.
24...240 V DC	Diode			Approval
24 V DC	Diode + LED			
	Diode/Z-Diode			
24 V AC/DC	VDR			cURus / CSA <b>26400</b>
	VDR + LED	<b>2000-68800-2300000</b>	<b>2000-69000-2300000</b>	
	RC			
48 V DC	Diode/Z-Diode			
48 V AC	VDR			cURus / CSA <b>26401</b>
	RC			
110 V AC/DC	VDR			
	VDR + LED			
	VDR-RC			
	RC	<b>2000-68800-7300000</b>		
230 V AC/DC	VDR			cURus / CSA <b>26403</b>
	VDR + LED			
	VDR-RC			
	VDR-RC + LED			
	RC	<b>2000-68800-2320000</b>		
400 V AC/DC	VDR			cURus / CSA <b>26404</b>
	RC			

**Technical Data**

Damping factor	$\sim 1.5 \times U_N$
Temperature range	-20...+70 °C
Material	plastic, flame retardant (UL 94)
Connection wires	self-securing cable forks

**Dimension drawing**

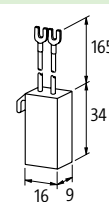
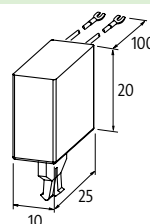
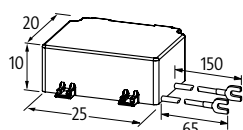

**Notes**

Further types on request.

# EMC SUPPRESSORS

## Suppressors for contactors



Approvals:

I00-C



### Circuit diagram

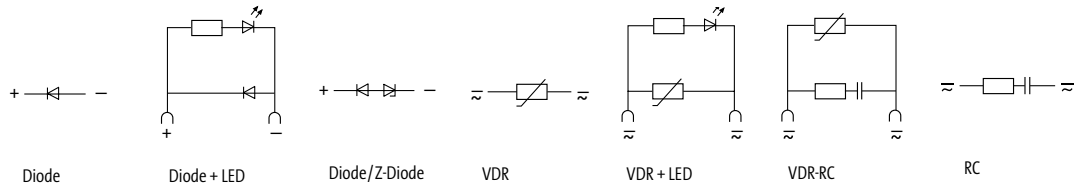

### Appropriate contactors

I00-C09...C85

### Order Data

Art.-No.

Voltage	Suppression	Art.-No.
24...240 V DC	Diode	2000-68200-1100000
24 V DC	Diode + LED	
24 V AC/DC	Diode /Z-Diode	
	RC	2000-68200-4300000
	VDR	2000-68200-4400000
48 V AC/DC	RC	2000-68200-4300000
	VDR	2000-68200-4400000
110 V AC/DC	VDR	2000-68200-7400000
	VDR + LED	
	VDR-RC	
	RC	2000-68200-1320000
	VDR	2000-68200-2420000
230 V AC/DC	VDR + LED	
	VDR-RC	
	VDR-RC + LED	
	RC	2000-68200-1320000
	VDR	2000-68200-5320000
400 V AC/DC	RC	2000-68200-5320000
	VDR	2000-68200-5420000

### Technical Data

Damping factor	$\sim 1.5 \times U_N$
Temperature range	-20...+70 °C
Material	plastic, flame retardant (UL 94)
Connection wires	plug contact

### Dimension drawing

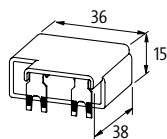

### Notes

# EMC SUPPRESSORS

## Suppressors for contactors



TeSys



TeSys



TeSys



### Circuit diagram

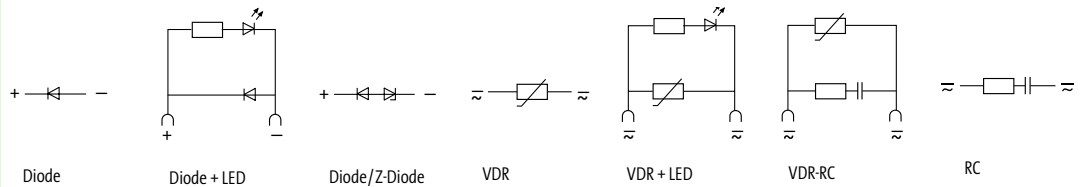

### Appropriate contactors

LC 1 D09...D38 LC 1 DT20, DT40, LC 2 D09...D38 AC-coil	LC 1 D09...D38 LC 1 DT20, DT40, LC 2 D09...D38 DC-coil	CA 2 DN, CA 3 DN serie „d“ LC 1 DT20, DT40, LC 2 D09...D38
--	--	---

Order Data	Art.-No.	Art.-No.	Art.-No.	Art.-No.		
Voltage	Suppression	Approval	Approval	Approval		
24...240 V DC	Diode		cURus	<b>2000-69300-1100000</b>		
24 V DC	Z-Diode	<b>26476</b>	cURus	<b>2000-69300-5200000</b>		
24 V AC/DC	VDR	cURus	<b>2000-69400-4400000</b>	cURus	<b>2000-69300-4400000</b>	
	RC	cURus	<b>2000-69400-4300000</b>	cURus	<b>2000-69300-4300000</b>	
30...250 V DC	Z-Diode					
48 V AC/DC	VDR	cURus	<b>2000-69400-4400000</b>	cURus	<b>2000-69300-4400000</b>	
	VDR + LED					
	RC	cURus	<b>2000-69400-4300000</b>	cURus	<b>2000-69300-4300000</b>	
110 V AC/DC	VDR	cURus	<b>2000-69400-7400000</b>	cURus	<b>2000-69300-7400000</b>	
	VDR + LED					
230 V AC/DC	RC	<b>21063</b>	cURus	<b>2000-69400-7300000</b>	cURus	<b>2000-69300-7300000</b>
	VDR		cURus	<b>2000-69400-2420000</b>	cURus	<b>2000-69300-2420000</b>
	VDR + LED					
	VDR-RC + LED					
400 V AC/DC	RC	<b>21063</b>	cURus	<b>2000-69400-2320000</b>	cURus	<b>2000-69300-2320000</b>
	RC + LED					
	VDR		cURus	<b>2000-69400-5420000</b>		
	RC		cURus	<b>2000-69400-5320000</b>		

### Technical Data

Damping factor	$\sim 1.5 \times U_N$
Temperature range	-20...+70 °C
Material	plastic, flame retardant (UL 94)

Connection wires	plug contact	self-securing cable forks	self-securing cable forks	plug contact
------------------	--------------	---------------------------	---------------------------	--------------

### Dimension drawing

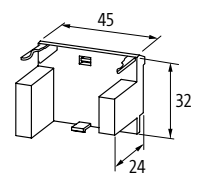
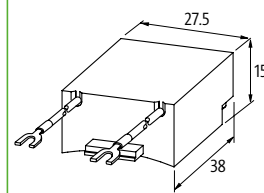
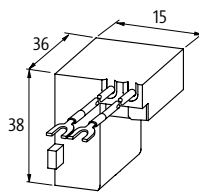
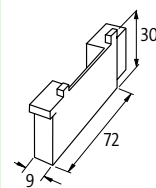

### Notes

# EMC SUPPRESSORS

Suppressors for contactors

S00

S0

**SIEMENS**



**Circuit diagram**

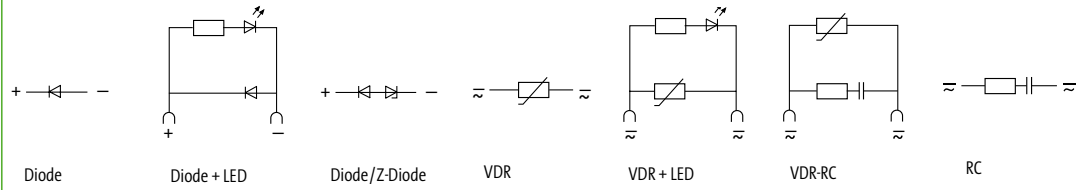

**Appropriate contactors**

3 RT 20.15/16/17/18

3 RT 20.25/26/27/28

**Order Data**

Voltage	Suppression	Art.-No.	Art.-No.
24...240 V DC	Diode	2000-68500-1100000	
24 V DC	Diode + LED		2000-68400-2010000
	Diode/Z-Diode		
24 V AC/DC	VDR	2000-68500-4400000	2000-68400-4400000
	VDR + LED	2000-68500-4410000	2000-68400-4410000
	RC	2000-68500-4300000	2000-68400-4300000
48 V AC/DC	VDR		
	RC	2000-68500-4300000	2000-68400-4300000
110 V AC/DC	VDR	2000-68500-7400000	2000-68400-7400000
	VDR + LED	2000-68500-7410000	2000-68400-7410000
	VDR-RC		
	RC	2000-68500-7300000	2000-68400-7300000
230 V AC/DC	VDR	2000-68500-2420000	2000-68400-2420000
	VDR + LED	2000-68500-2470000	
	RC	2000-68500-2320000	2000-68400-2320000
400 V AC/DC	VDR	2000-68500-5420000	2000-68400-5420000
	RC	2000-68500-5320000	2000-68400-5320000

**Technical Data**

Damping factor	$\sim 1.5 \times U_N$
Temperature range	-20...+70 °C
Material	plastic, flame retardant (UL 94)
Connection wires	plug contact

**Dimension drawing**

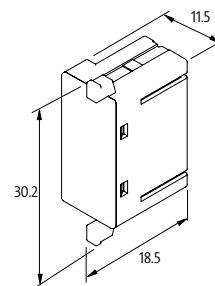
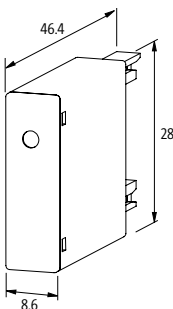

**Notes**

Suppressors for contactors

## SIEMENS

S0 4



S0 1



3 TF/L-3 TF



### Circuit diagram

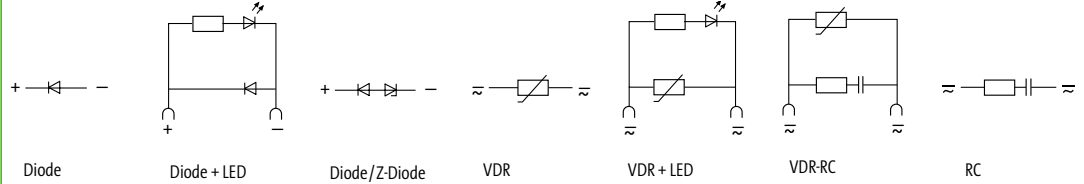

### Appropriate contactors

3 TF 30...35  
3 TF 40...45

3 TF 30...45  
3 TB 40...3 TB 44

3 TH 2, 3 TF 2  
3 TH 20, 3 TF 20

### Order Data

Order Data		Art.-No.	Art.-No.	Art.-No.
Voltage	Suppression	Approval	Approval	Approval
24...240 V DC	Diode	CSA	UR / CSA	cURus / CSA
24 V DC	Diode + LED	<b>26588</b>	<b>26283</b>	<b>26036</b>
	Diode/Z-Diode		UR / CSA	cURus / CSA
			<b>26051</b>	<b>26034</b>
24 V AC/DC	VDR	CSA		
	VDR + LED			
	RC		UR / CSA	<b>22050</b>
48 V DC	Diode/Z-Diode			
48 V AC/DC	VDR	CSA	<b>26576</b>	cURus / CSA
	RC		UR / CSA	<b>22051</b>
110 V AC/DC	VDR			
	VDR + LED			
	VDR-RC			
	RC		UR / CSA	<b>22051</b>
230 V AC/DC	VDR	CSA	<b>26578</b>	UR / CSA
	VDR + LED			<b>26317</b>
	VDR-RC			cURus / CSA
	RC		UR / CSA	<b>26039</b>
	RC		UR / CSA	<b>22052</b>
	RC		UR / CSA	<b>22054</b>
400 V AC/DC	VDR			
	RC		UR / CSA	<b>22054</b>

### Technical Data

Damping factor	$\sim 1.5 \times U_N$
Temperature range	-20...+70 °C
Material	plastic, flame retardant (UL 94)
Connection wires	self-securing cable forks

### Dimension drawing

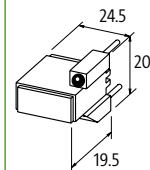
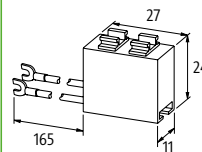
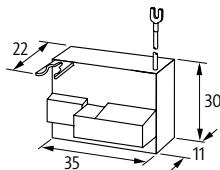

### Notes

# EMC SUPPRESSORS

## Suppressors

– universal

AO



AD



CF



### Circuit diagram

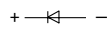

Diode

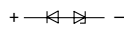

Diode/Z-Diode

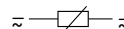

VDR

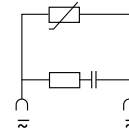

VDR-RC

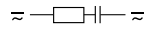

RC

### Appropriate contactors

universal

universal

universal

Order Data		Art.-No.	Art.-No.	Art.-No.	sugg. coil valves		
Voltage	Suppression	Approval	Approval	Approval	AO	AD	CF
Max. 240 V DC	Diode	CSA <b>26001</b>			15 W		
24V DC	Z-Diode	CSA <b>26120</b>	CSA <b>26073</b>		25 W	75 W	
24V AC/DC	VDR	cURus / CSA <b>26180</b>	CSA <b>26720</b>		50 VA/W	200 VA/W	
	RC			CSA <b>20680</b>			20 VA
48V AC/DC	VDR	cURus / CSA <b>26181</b>			70 VA/W		
	RC	cURus / CSA <b>20001</b>	cURus / CSA <b>20013</b>		15 VA	15 VA	
110V AC/DC	VDR	cURus / CSA <b>26182</b>	CSA <b>26722</b>		100 VA/W	200 VA/W	
	VDR-RC						
230V AC/DC	RC						
	VDR	cURus / CSA <b>26183</b>	CSA <b>26723</b>		200 VA/W	200 VA/W	
400V AC/DC	VDR	cURus / CSA <b>26184</b>			200 VA/W		
	RC		CSA <b>20014</b>	CSA <b>20682</b>		25 VA	20 VA
	RC	cURus / CSA <b>20002</b>	cURus / CSA <b>20010</b>	CSA <b>20683</b>	15 VA	75 VA	20 VA
	RC		cURus / CSA <b>20011</b>	CSA <b>20687</b>		100 VA	50 VA
400V AC/DC	VDR		CSA <b>26724</b>			200 VA/W	
	RC	cURus / CSA <b>20004</b>	cURus / CSA <b>20012</b>	CSA <b>20688</b>	15 VA	100 VA	50 VA
RC							

### Technical Data

Damping factor approx. 1.5

Temperature range -20...+70 °C

Material plastic, flame retardant (UL 94)

Connection wires self-securing cable forks

flexible connection wires

### Dimension drawing

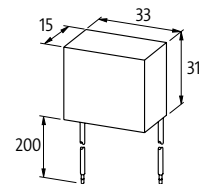
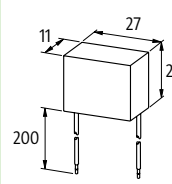
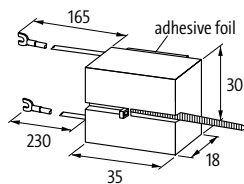
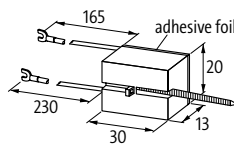

Form 1

<sup>2)</sup> Form 2

### Notes

Art.-No. 26184 – up to 300 V AC/DC

# EMC SUPPRESSORS

## Suppressors

– universal

H

RC-BUG 2

BU + UB



### Circuit diagram

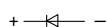

Diode

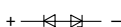

Diode/Z-Diode

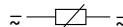

VDR

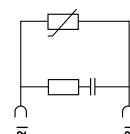

VDR-RC

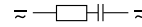

RC

### Appropriate contactors

universal

universal

universal

### Order Data

		Art.-No.		Art.-No.			sugg. coil valves			
Voltage	Suppression	Approval		Approval		Approval		H	RC-BUG 2	BU + UB
24...240 V DC	Diode	CSA	<b>26097</b>			CSA	<b>26020</b>	25 W		50 W
24 V DC	Z-Diode	CSA	<b>26095</b>			CSA	<b>26130</b>	25 W		50 W
24 V AC/DC	VDR	cURus / CSA	<b>26090</b>			cURus / CSA	<b>26150</b>	50 VA/W		50 VA/W
	RC									
48 V AC/DC	VDR									
	RC	CSA	<b>20100</b>					15 VA		
110 V AC/DC	VDR									
	VDR-RC									
	RC			CSA	<b>26613</b>				146 VA	
230 V AC/DC	VDR			CSA	<b>26619</b>	cURus / CSA	<b>26155</b>		100 VA/W	200 VA/W
	VDR			CSA	<b>26614</b>	CSA	<b>20031</b>	15 VA	146 VA	25 VA
	RC	CSA	<b>20101</b>	CSA	<b>26614</b>	CSA	<b>20033</b>	25 VA		25 VA
	RC	CSA	<b>20102</b>			CSA	<b>20034</b>	75 VA		25 VA
	RC	CSA	<b>20103</b>			CSA	<b>20034</b>			25 VA
400 V AC/DC	VDR									
	RC			CSA	<b>26615</b>	CSA	<b>20032</b>		146 VA	25 VA
	RC			CSA	<b>26616</b>				146 VA	

### Technical Data

Damping factor	approx. 1.5	
Temperature range	-20...+70 °C	
Material	plastic, flame retardant (UL 94)	
Mounting method	DIN-rail mounting (EN 60715)	with adapter ASA Art.-No. 20900, DIN-rail mounting (EN 60715)
Connection wires	self-securing cable forks	

### Dimension drawing

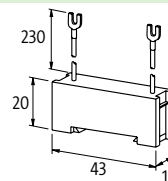
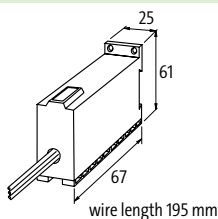
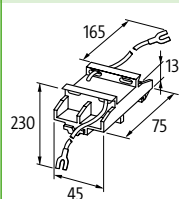

### Notes

**Art.-No. 20034** – without adapter, can be directly snapped onto DIN-rail, ASA adapter **Art.-No. 20900** included in delivery.  
**Art.-No. 26616** – up to 600 V AC/DC

EMC Suppressors

# EMC SUPPRESSORS

## Suppressors for motors

### Mounting methods:

- on the motor terminal box
- inside the motor terminal box
- inside the distribution box
- on 35 mm DIN-rail acc. to EN 60715

### RC 3 U

M16 x 1.5



### RC 3 BU



### RC 3 BUG



### Circuit diagram

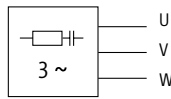

RC

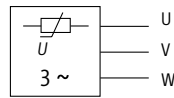

VDR

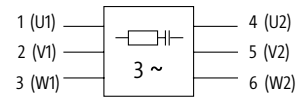

RC-(1) per phase

Order Data		Art.-No.	Art.-No.	Art.-No.
3 × 400 V AC	Motor rating	Suppression/Approval	Suppression/Approval	Suppression/Approval
	4 kW	RC	RC / cURus	RC
	4 kW			VDR
	4 kW		VDR / cURus	RC
	7.5 kW		VDR / cURus	RC
	10 kW	RC	VDR / cURus	RC
	10 kW	RC-per phase		
3 × 575 V AC	4 kW		VDR / cURus	
	7.5 kW	RC / cURus	RC / cURus	RC
	20 kW			VDR
	45 kW			RC-per phase
3 × 690 V AC	4 kW		RC / cURus	RC
	7.5 kW			RC
	20 kW			

### Technical Data

Frequency	for RC: 50...60 Hz; for VDR: 10...400 Hz		
Material	plastic, flame retardant (UL 94)		
Potting compound	2-component epoxy		
Temperature range	-20...+60 °C		
Connection method	approx. 500 mm PVC cable 3 × 0.75 mm <sup>2</sup> or 7 × 0.75 mm <sup>2</sup>	approx. 200 mm single core 0.35 mm <sup>2</sup> ; <b>Art.-No. 23056</b> 0.5 mm <sup>2</sup> with self-securing M4 cable forks M4	approx. 500 mm single core 1 mm <sup>2</sup>

### Dimension drawing

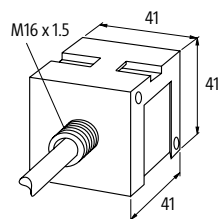

For DIN-rail mounting use  
2 × **Art.-No. 20900** adapter feet

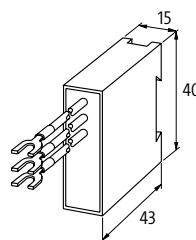

For DIN-rail mounting use  
**Art.-No. 20900** adapter feet

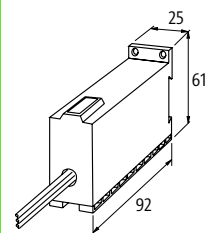

For DIN-rail mounting use  
2 × **Art.-No. 20900** adapter feet

### Notes

Do not use RC motor suppressors on variable frequency drives.  
1 × **Art.-No. 23103, 23043** required per phase.



# EMC SUPPRESSORS

## Suppressors for motors

### Mounting methods:

- with M16 × 1.5 and M20 × 1.5
- on the motor terminal box with plug connectors

### RC 3 R

M16 × 1.5 screw



### RC 3 R

M16 × 1.5 screw

### RC 3 RG

M20 × 1.5 screw



### Circuit diagram

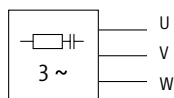

RC

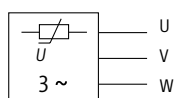

VDR

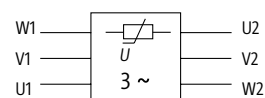

VDR-(1) per phase

Order Data		Art.-No.	Art.-No.	Art.-No.
Voltage	Motor rating	Suppression/Approval	Suppression/Approval	Suppression/Approval
3 × 400 V AC	4 kW	VDR / cURus	<b>23170</b>	VDR / cURus
	4 kW			
	4 kW			
	7.5 kW	VDR	<b>23171</b>	
	10 kW			VDR
3 × 575 V AC	20 kW			VDR
	4 kW	VDR / cURus	<b>23172</b>	RC / cURus
	7.5 kW	VDR / cURus	<b>23173</b>	
	10 kW			VDR / cURus
	20 kW			VDR / cURus
3 × 690 V AC	20 kW			VDR-Einzel
	7.5 kW	VDR	<b>23174</b>	
	20 kW			VDR

### Technical Data

Frequency	for RC: 50...60 Hz; for VDR: 10...400 Hz		
Material	plastic, flame retardant (UL 94)		
Potting compound	2-component epoxy		
Temperature range	-20...+60 °C		
Connection method	approx. 100 mm single core 0.5 mm <sup>2</sup>		approx. 150 mm single core 1 mm <sup>2</sup>
Ring terminals	isolated M6	isolated M4	isolated M6

### Dimension drawing

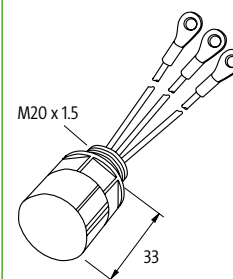
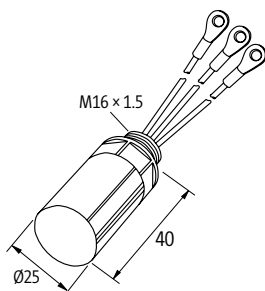

### Notes

Do not use RC motor suppressors on variable frequency drives.  
**Art.-No. 23174** – wire diameter 1.5 mm<sup>2</sup>.

# EMC SUPPRESSORS

## Suppressors for motors

### Mounting methods:

- on the motor terminal box with plug connectors

### RC 3 ST

Connector with cable and integrated motor suppression  
Cable outlet in the back



### RC 3 ST

Connector with cable and integrated motor suppression  
Cable outlet (right angle)



### Circuit diagram

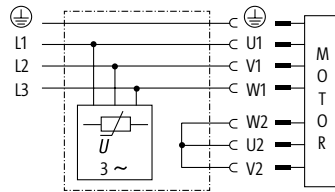

Varistor-suppression (star)

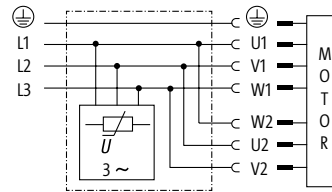

Varistor-suppression (delta)

Order Data			Art.-No.	Art.-No.
Voltage	Motor rating	Cable length	Suppression	Suppression
max.	5.5 kW	5 m	VDR/star	VDR/star
3 × 575 V AC	5.5 kW	8 m	VDR/star	
	5.5 kW	10 m	VDR/star	
			<b>236139</b>	<b>236148</b>
			<b>236141</b>	
			<b>236142</b>	<b>236149</b>

### Technical Data

Frequency	10...400 Hz		
Plug connector	females, 10-pol. + PE		
Housing	aluminium pressure diecasting		
Temperature range	-20...+60 °C		
Connection method	PUR cable black, 4 × 1.5 mm <sup>2</sup> ; numbered wires, halogen free	PUR cable black, 4 × 1.5 mm <sup>2</sup> ; numbered wires, DESINA® compliant	

### Dimension drawing

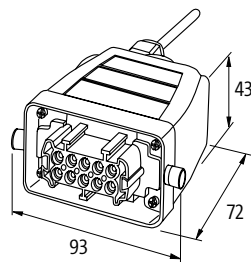

(without compression gland)

### Notes

## Suppressors for motors

### Mounting methods:

- on 35 mm DIN-rail acc. to EN 60715
- bolted together, stacked
- DIN-rail mounting under the control gear

### HRC 3



### HRC 3 K



### RC 3 BUR

Connects onto Siemens SIRIUS 3 RT 20 contactors, with screw terminal



### RC 3 BUC

Connects onto Siemens SIRIUS 3 RT 20 contactors, with spring clamp terminal



### Circuit diagram

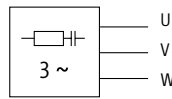

RC

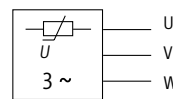

VDR

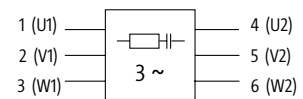

RC(1) per phase

Order Data		Art.-No.	Art.-No.	Art.-No.	Art.-No.
Voltage	Motor rating	Suppression/Approval	Suppression	Suppression/Approval	Suppression/Approval
3 × 400 V AC	4 kW	RC / cURus <b>23004</b>	RC <b>23005</b>		
	4 kW	RC / cURus <b>233463</b>			
	5.5 kW			RC / cURus <b>236082</b>	
	7.5 kW				RC / cURus <b>23220</b>
	10 kW	RC / cURus <b>23002</b>	RC <b>23003</b>		
	20 kW	RC-per phase / cURus <b>23009</b>			
3 × 500 V AC +10 %	20 kW	VDR / cURus <b>23015</b>			
	4 kW	RC / cURus <b>23000</b>	RC <b>23001</b>		
3 × 575 V AC	5.5 kW			RC / cURus <b>236082</b>	
	7.5 kW	RC / cURus <b>23006</b>	RC <b>23007</b>		
	7.5 kW	RC / cURus <b>230563</b>			RC / cURus <b>23220</b>
	10 kW	VDR / cURus <b>23016</b>			
	20 kW		RC <b>23018</b>		
3 × 690 V AC	10 kW	RC <b>23017</b>			

### Technical Data

Frequency	for RC: 50...60 Hz; for VDR: 10...400 Hz			
Material	plastic, flame retardant (UL 94)			
Potting compound	2-component epoxy			
Temperature range	-20...+60 °C			
Connection method	approx. 250 mm s. core (Art.-No. 23000: 300 mm) 0.5 mm <sup>2</sup> (Art.-No. 23000: 1.5 mm <sup>2</sup> ) with self-securing M4 cable forks	3-pole terminal 2 × (0.75...2.5 mm <sup>2</sup> ) M4	wire (solid core) 1.5 mm <sup>2</sup>	wire with ferrule ends 2.0 mm <sup>2</sup>

### Dimension drawing

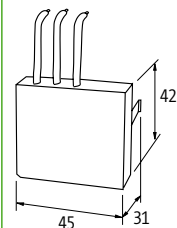
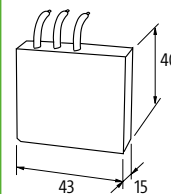
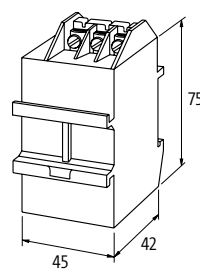
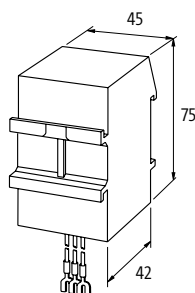

### Notes

Do not use RC motor suppressors on variable frequency drives.  
Art.-No. 233463 and 230563 – with ferrule ends.

# EMC SUPPRESSORS

## Suppressors for motors

### Mounting methods:

- DIN-rail mounting under the control gear
- fixes onto contactors
- available with integrated coil suppression

## HRC 3 AS



## RC 3 RT

Connects onto Siemens SIRIUS 3 RT 10 contactors with screw terminal



### Circuit diagram

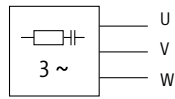

RC

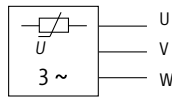

VDR

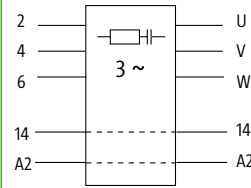

### Appropriate contactors

Motor contactors up to 5.5 kW from Siemens, Moeller, Sprecher + Schuh etc.

Siemens 3 RT 10

Order Data		Art.-No.	Art.-No.	Art.-No.
Voltage	Motor rating	Suppression motor + coil	Suppression motor + coil	Suppression / Approval
3 × 400 V AC	5.5 kW	RC	<b>23160</b>	VDR
	5.5 kW	RC + Diode	<b>23151</b>	<b>23163</b>
3 × 575 V AC	5.5 kW	RC	<b>23161</b>	VDR
	5.5 kW			VDR + Diode
				<b>23164</b>
				<b>23157</b>
				RC / cURus / CSA
				<b>23180</b>
				RC / cURus / CSA
				<b>23181</b>

### Technical Data

Suppression Spule for RC: 230 V AC/20 VA; for RC + Diode: 24...230 V DC/36 W

Frequency for RC: 50...60 Hz; for VDR: 10...400 Hz

Material plastic, flame retardant (UL 94)

Temperature range -20...+60 °C

Connection method ferrules, load side securely fixed

fits directly into SIRIUS contactors, size 00

### Dimension drawing

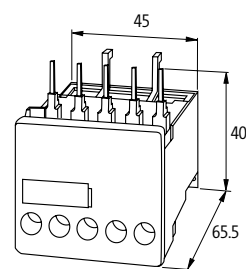
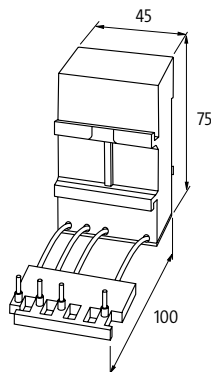

### Notes

Do not use RC motor suppressors on variable frequency drives.

## Suppressors for valves

- with LED
- with suppression

### VBS

Form A  
Pin spacing 18 mm  
EN 175301-803 (ISO 4400)



### LBS

Form BI Industrial Standard  
Pin spacing 11 mm



### Circuit diagram

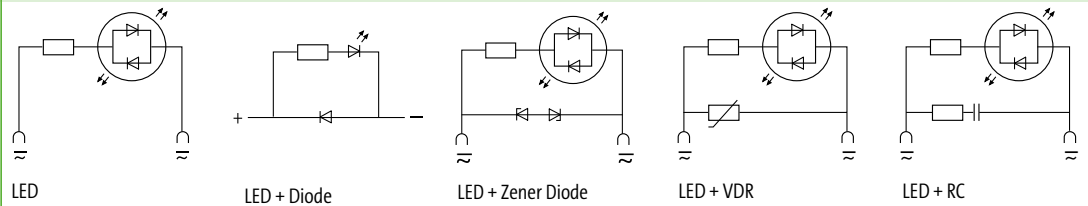

Order Data		Art.-No.	Art.-No.	Switch off delay time [ms]	Switch off voltage peak [V]	Valve hold-on rating [W/VA]
Voltage	Suppression					
24 V DC	LED + Diode	<sup>1)</sup> 3124021	3124221	200	1	50
24 V AC/DC	LED	<sup>1)</sup> 3124015	3124215	-	-	50
	LED + Z-Diode	<sup>1)</sup> 3124033	3124233	20	55	100
	LED + VDR	<sup>1)</sup> 3124048	3124248	15	45	50
	LED + RC	3124068		20	105	10
	LED + RC		3124269	20	70	20
48 V AC/DC	LED	<sup>1)</sup> 3124017		-	-	50
	LED + VDR	<sup>1)</sup> 3124052		10	75	100
	LED + RC	<sup>2)</sup> 3124071		20	90	30
110 V AC/DC	LED	3124018		-	-	50
	LED + VDR	3124046		10	235	100
	LED + RC	3124070		20	250	10
	LED + RC	<sup>2)</sup> 3124072		20	250	25
230 V AC/DC	LED	3124016	3124216	-	-	50
	LED + VDR	3124049	3124249	15	360	100
	LED + RC	3124063	3124263	20	300	10
	LED + RC	<sup>2)</sup> 3124064		20	300	25

### Technical Data

Supply indicator	LED yellow
Contact material	silvered bronze
Protection	IP65 when fully mounted
Material	polyamide black, flame retardant, temperature resistant up to 130 °C
Temperature range	-20...+60 °C

### Dimension drawing

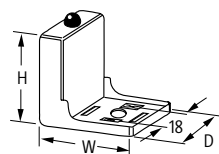

Housing H × W × D: 37 × 45 × 30 mm  
<sup>1)</sup> Housing H × W × D: 37 × 39 × 30 mm  
<sup>2)</sup> Housing H × W × D: 37 × 53 × 33 mm  
 0° and 180° version on request

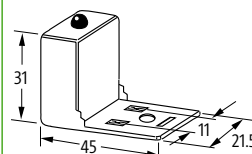

Note PIN arrangement (PE at cable outlet of connector)  
 180° version on request

### Notes

Do not use plug gasket when fitting adapter. Other LED colors on request.  
 For double valves the VA 2 series is suitable (please inquire). At Art.-No. 3124021 and 3124221 polarity dependent

# EMC SUPPRESSORS

## Suppressors for valves

- with LED
- with suppression

### DAB/PBS

Form B/BI  
Pin spacing 10/11 mm  
EN 175301-803 (ISO 6952)



### MVK/MVT

Form C/CI  
Pin spacing 8/9.4 mm  
EN 175301-803 (ISO 6952)



### Circuit diagram

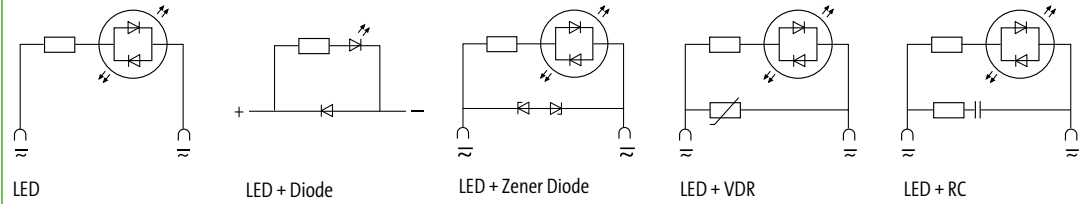

Order Data		Art.-No.	Art.-No.	Art.-No.	Art.-No.	Switch off delay time	Switch off voltage peak	Valve-hold-on rating
Voltage	Suppression	EN 175301-803 (ISO 6952)		EN 175301-803 (ISO 6952)		[ms]	[V]	[W/VA]
		Form B	Form BI	Form C	Form CI			
24 V DC	LED + Diode	<b>3124871</b>	<b>3124121</b>			200	1	50
24 V AC/DC	LED	<b>3124875</b>	<b>3124115</b>	<b>3124811</b>	<b>3124815</b>	-	-	50
	LED + Z-Diode	<b>3124873</b>	<b>3124133</b>	<b>3124833</b>	<b>3124832</b>	20	55	100
	LED + VDR		<b>3124148</b>			15	45	50
	LED + RC		<b>3124169</b>			20	70	20
110 V AC/DC	LED + RC		<b>3124170</b>			20	250	10
230 V AC/DC	LED		<b>3124116</b>			-	-	50
	LED + VDR					15	360	100
	LED + RC		<b>3124163</b>			20	300	10

### Technical Data

Supply indicator	LED yellow
Contact material	silvered bronze
Protection	IP65 when fully mounted
Material	polyamide black, flame retardant, temperature resistant up to 130 °C
Temperature range	-20...+60 °C

### Dimension drawing

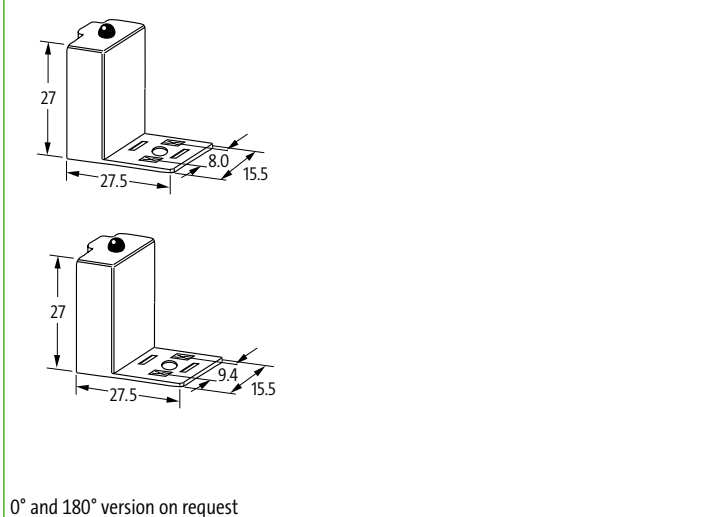
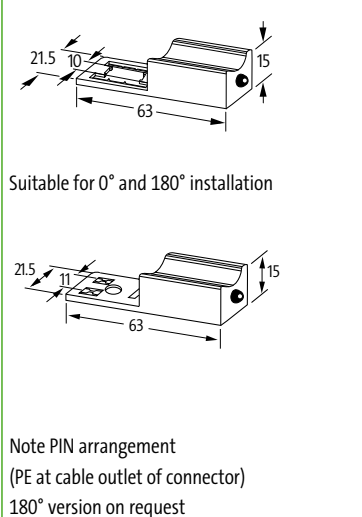

### Notes

Do not use plug gasket when fitting adapter. Other LED colors on request. Right-angle housing version with 10 mm pin spacing (DAR/DARU), on request. At **Art.-No. 3124871** and **3124121** polarity dependent.

# RELAYS / SAFETY RELAYS INCREDIBLY VERSATILE

- Over 600 different modules ready for all applications
- Push-In technology, spring clamps or screw terminals available
- Worldwide approvals

## TWICE AS SMALL, TWICE AS FAST!

Each system includes different kinds of active interface modules. Relay modules are used to separate two different potential levels. The control side is galvanically isolated from the load/contact side and should be protected from the wrong voltage. These interfaces adjust the different signal levels to work with the existing system.

With MIRO SAFE+, Murrelektronik offers safe switching devices for a wide range of safe industrial applications. They are the perfect solution to reach high safety standards – up to performance level e (PLe) according to EN 13849-1. **With MIRO SAFE+ you can design many different safety applications like: emergency stops, guard doors, two hand monitoring, light curtains, and safety magnet switch monitoring.**

## Relays



### Relay 6.2 mm pluggable

- Output relay
- Input relay

Page 1.9.1



### Relay 6.2 mm

- Output relay
- Input relay

Page 1.9.4



### Relay 12.4 mm

- Output relay
- Input relay

Page 1.9.9



### Relay 22.5 mm

- Output relay
- Input relay

Page 1.9.17

## Safety Relays



### Safety Relay 22.5/45 mm

- MIRO SAFE+

Page 1.9.20

## RELAYS / SAFETY RELAYS

### Terminal relay

- pluggable
- with bridge system

Approvals:  

### MIRO 6.2

Output relay  
1 NO/NC contact  
Spring clamp terminals



### Circuit diagram

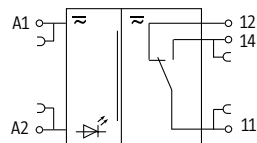

### Order Data

	Art-No.
6 V AC/DC (5...7.2 V AC/DC) - 25 mA	3000-16023-3100022
12 V AC/DC (9.8...14 V AC/DC) - 14.2 mA	3000-16023-3100005
24 V AC/DC (19.2...28.8 V AC/DC) - 12 mA	3000-16013-3100020

### Accessories

	Art-No.
Removable plug-in relay 6 V AC/DC	3000-16023-2100000
Removable plug-in relay 12 V AC/DC	3000-16023-2100005
Removable plug-in relay 24 V AC/DC	3000-16023-2100010

### Utilization category

AC-12	6 A (24/110/230 V AC)
AC-15	3 A (24/110 V AC); 1.5 A (230 V AC)
DC-13	1 A (24 V DC); 0.2 A (110 V DC); 0.1 A (230 V DC)

### Input

LED display	LED (green)
-------------	-------------

### Output

Switching voltage	max. 250 V AC/30 V DC
Switching current per output	max. 6 A
Min. load current	100 mA
Power rating (voltage dependent)	max. 1 500 VA/180 W
Switching frequency	max. 10 Hz
Contact material	Ag Sn O <sub>2</sub>
Energize/release/contact bounce time	8/4/- ms

### General data

Test isolation voltage	250 V
Mech./ elect. life	10 000 000 switching cycles (NO) 30 000; (NC) 10 000, load dependent
Protection	IP20
Mounting method	DIN-rail mountable (EN 60715)
Temperature range	-25...+60 °C

### Dimension drawing

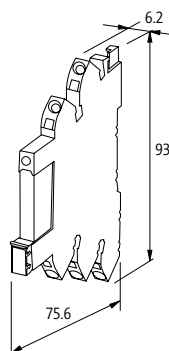

### Notes

For inductive loads we recommend EMC suppressors connected parallel to the coil.



## RELAYS / SAFETY RELAYS

### Terminal relay

– pluggable

– with bridge system

### MIRO 6.2

Output relay  
1 NO/NC contact  
Spring clamp terminals



### Circuit diagram

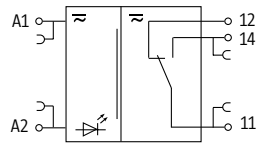

Order Data	Art-No.
60 V AC/DC (43.5...72 V AC/DC) - 7 mA	cURus, cCSAus 3000-16513-3100022
115...125 V AC/DC (88...138 V AC/DC) - 8 mA	3000-16013-3100025
230 V AC/DC (184...264 V AC/DC) - 4 mA	3000-16013-3100030

Accessories	Art-No.
Relay 60/125/230 V AC/DC	3000-16023-2100020

Utilization category	
AC-12	6 A (24/110/230 V AC)
AC-15	3 A (24/110 V AC); 1.5 A (230 V AC)
DC-13	1 A (24 V DC); 0.2 A (110 V DC); 0.1 A (230 V DC)

Input	
LED display	LED (green)

Output	
Switching voltage	max. 250 V AC/30 V DC
Switching current per output	max. 6 A
Min. load current	100 mA
Power rating (voltage dependent)	max. 1 500 VA/180 W
Switching frequency	max. 10 Hz
Contact material	Ag Sn O <sub>2</sub>
Energize/release/contact bounce time	8/4/- ms

General data	
Test isolation voltage	250 V
Mech./ elect. life	10 000 000 switching cycles (NO) 30 000; (NC) 10 000, load dependent
Protection	IP20
Mounting method	DIN-rail mountable (EN 60715)
Temperature range	-25...+60 °C

### Dimension drawing

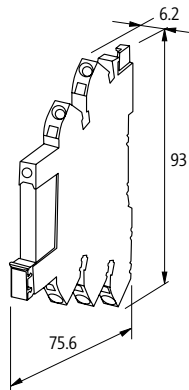

Notes	
	For inductive loads we recommend EMC suppressors connected parallel to the coil.

## RELAYS / SAFETY RELAYS

### Terminal relay

- pluggable
- with bridge system

Approvals:   

### MIRO 6.2

Input relay  
1 NO/NC contact  
Spring clamp terminals



### Circuit diagram

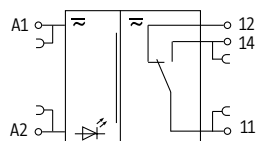

### Order Data

24 V AC/DC (19.2...26.8 V AC/DC) - 14 mA

### Art-No.

3000-16013-3100040

### Accessories

Removable plug-in relay 24 V AC/DC

### Art-No.

3000-16023-2100030

### Utilization category

AC-12	6 A (24/110/230 V AC)
AC-15	3 A (24/110 V AC); 1.5 A (230 V AC)
DC-13	1 A (24 V DC); 0.2 A (110 V DC); 0.1 A (230 V DC)

### Input

LED display LED (green)

### Output

Switching voltage	max. 250 V AC/30 V DC
Switching current per output	max. 6 A
Min. load current	10 mA
Power rating (voltage dependent)	max. 1 500 VA/180 W
Switching frequency	max. 10 Hz
Contact material	Ag Sn O <sub>2</sub> , gold plated
Energize/release/contact bounce time	8/4/- ms

### General data

Test isolation voltage	250 V
Mech./ elect. life	10 000 000 switching cycles (NO) 30 000; (NC) 10 000, load dependent
Protection	IP20
Mounting method	DIN-rail mountable (EN 60715)
Temperature range	-25...+60 °C

### Dimension drawing

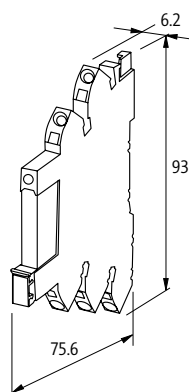

### Notes

For inductive loads we recommend EMC suppressors connected parallel to the coil. When the max. switching voltage/current is exceeded the gold plating is destroyed. The relay will then take on the properties of an output type.

# RELAYS / SAFETY RELAYS

## Terminal relay

– with bridge system

Approvals:  

### MIRO 6.2

Output relay  
1 NO/NC contact  
Screw terminals



### MIRO 6.2

Output relay  
1 NO/NC contact  
Spring clamp terminals



### MIRO 6.2

Output relay  
1 NO contact  
Screw terminals



### MIRO 6.2

Output relay  
1 NO contact  
Spring clamp terminals



## Circuit diagram

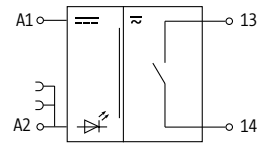
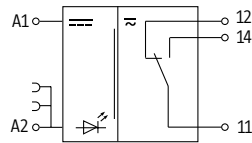

Order Data	Art-No.	Art-No.	Art-No.	Art-No.
12 V DC (10...15 V DC) - 20 mA	52050	6652050		
24 V DC (19.2...30 V DC) - 14 mA	CCC 52000	CCC 6652000	CCC 52002	CCC 6652002
24 V DC (19.2...30 V DC) - 17 mA	CCC 52001	CCC 6652001	CCC 52015	CCC 6652015

## Utilization category

AC-12	6 A (24/110/230 V AC)
AC-15	3 A (24/110/230 V AC)
DC-13	1 A (24 V DC); 0.2 A (110 V DC); 0.1 A (230 V DC)

Input	Output
LED display	LED (green)
Switching voltage	max. 250 V AC/DC
Switching current per output	max. 6 A
Min. load current	10 mA (12 V DC)   100 mA (12 V DC)
Power rating (voltage dependent)	max. 1 500 VA/120 W
Switching frequency	max. 10 Hz
Contact material	Ag Sn O <sub>2</sub>
Energize/release/contact bounce time	10/15/1.5 ms

## General data

Mech./ elect. life	20 000 000 switching cycles/load dependent
Test isolation voltage	4 kV; safe separation (EN 60947-1)
Mounting method	DIN-rail mountable (EN 60715)
Temperature range	-20...+55 °C

## Dimension drawing

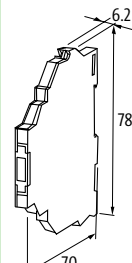
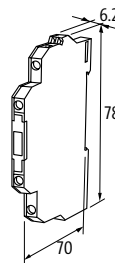
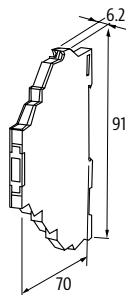
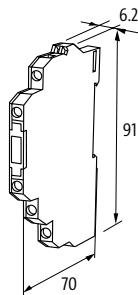

## Notes

For inductive loads we recommend EMC suppressors connected parallel to the coil.

# RELAYS / SAFETY RELAYS

## Terminal relay

– with bridge system

Approvals:   

### MIRO 6.2

Output relay  
1 NO/NC contact  
Screw terminals



### MIRO 6.2

Output relay  
1 NO/NC contact  
Spring clamp terminals



## Circuit diagram

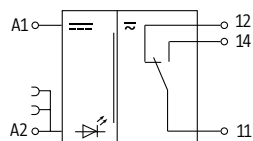

## Order Data

110 V AC/DC (95...121 V AC/DC) - 4 mA  
230 V AC/DC (195...253 V AC/DC) - 3 mA

## Art-No.

52030  
52040

## Art-No.

6652030  
6652040

## Utilization category

AC-12 6 A (24/110/230 V AC)  
AC-15 3 A (24/110/230 V AC)  
DC-13 1 A (24 V DC); 0.2 A (110 V DC); 0.1 A (230 V DC)

## Input

LED display LED (green)

## Output

Switching voltage max. 250 V AC/DC  
Switching current per output max. 6 A  
Min. load current 10 mA (12 V DC)  
Power rating (voltage dependent) max. 1 500 VA/120 W  
Switching frequency max. 10 Hz  
Contact material Ag Sn O2  
Energize/release/contact bounce time 10/15/1.5 ms

## General data

Mech./ elect. life 20 000 000 switching cycles/load dependent  
Test isolation voltage 4 kV; safe separation (EN 60947-1)  
Mounting method DIN-rail mountable (EN 60715)  
Temperature range -20...+55 °C

## Dimension drawing

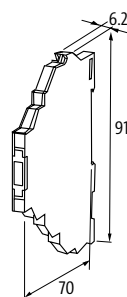
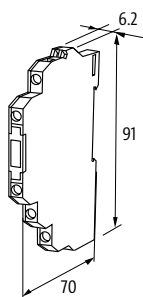

## Notes

For inductive loads we recommend EMC suppressors connected parallel to the coil.

# RELAYS / SAFETY RELAYS

## Terminal relay

– with bridge system

Approvals:   

### MIRO 6.2

Input relay  
1 NO/NC contact  
Screw terminals



### MIRO 6.2

Input relay  
1 NO/NC contact  
Spring clamp terminals



## Circuit diagram

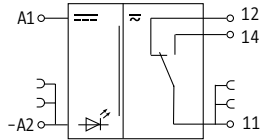

Order Data	Art-No.	Art-No.
24 V DC (19.2...30 V DC) - 14 mA	52005	6652005
24 V AC/DC (19.2...30 V AC/DC) - 16 mA	52003	6652003

## Utilization category

AC-12	6 A (24/110/230 V AC)
AC-15	3 A (24/110/230 V AC)
DC-13	1 A (24 V DC); 0.2 A (110 V DC); 0.1 A (230 V DC)

## Input

LED display LED (yellow)

## Output

Switching voltage	max. 30 V AC/36 V DC
Switching current per output	max. 6 A
Switching current per output (Signal)	max. 20 mA
Min. load current	1 mA (12 V DC)
Power rating (voltage dependent)	max. 1 500 VA/120 W
Switching frequency	max. 10 Hz
Contact material	Ag Sn O <sub>2</sub> hv
Energize/release/contact bounce time	10/15/1.5 ms

## General data

Mech./ elect. life	20 000 000 switching cycles/load dependent
Test isolation voltage	4 kV; safe separation (EN 60947-1)
Mounting method	DIN-rail mountable (EN 60715)
Temperature range	-20...+55 °C

## Dimension drawing

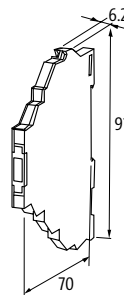
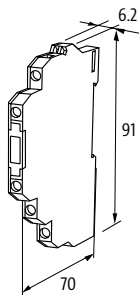

## Notes

For inductive loads we recommend EMC suppressors connected parallel to the coil. When the max. switching voltage/current is exceeded the gold plating is destroyed. The relay will then take on the properties of an output type.

# RELAYS / SAFETY RELAYS

## Terminal relay

– with bridge system

Approvals:   

### MIRO 6.2

Input relay  
1 NO contact  
Screw terminals



### MIRO 6.2

Input relay  
1 NO contact  
Spring clamp terminals



## Circuit diagram

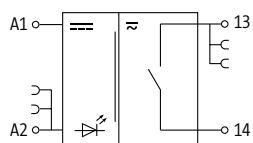

## Order Data

24 V DC (19.2...30 V DC) - 14 mA

## Art-No.

52004

## Art-No.

6652004

## Utilization category

AC-12	6 A (24/110/230 V AC)	
AC-15	3 A (24/110/230 V AC)	
DC-13	1 A (24 V DC); 0.2 A (110 V DC); 0.1 A (230 V DC)	3 A (24/110/230 V AC)

## Input

LED display LED (yellow)

## Output

Switching voltage	max. 30 V AC/36 V DC
Switching current per output	max. 50 mA
Min. load current	1 mA (12 V DC)
Power rating (voltage dependent)	max. 1 500 VA/120 W
Switching frequency	max. 10 Hz
Contact material	Ag Sn O2 hv
Energize/release/contact bounce time	10/15/1.5 ms

## General data

Mech./ elect. life	20 000 000 switching cycles/load dependent
Test isolation voltage	4 kV; safe separation (EN 60947-1)
Mounting method	DIN-rail mountable (EN 60715)
Temperature range	-20...+55 °C

## Dimension drawing

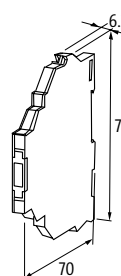
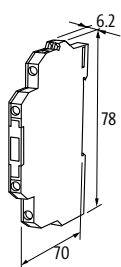

## Notes

For inductive loads we recommend EMC suppressors connected parallel to the coil. When the max. switching voltage/current is exceeded the gold plating is destroyed. The relay will then take on the properties of an output type.

# RELAYS / SAFETY RELAYS

## Terminal relay

– with bridge system

Approvals:  

### MIRO 6.2

Input relay  
1 NO/NC contact  
Screw terminals



### MIRO 6.2

Input relay  
1 NO/NC contact  
Spring clamp terminals



## Circuit diagram

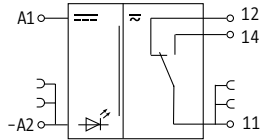

Order Data	Art-No.	Art-No.
110 V AC/DC (95...121 V AC/DC) - 4 mA	52031	6652031
230 V AC/DC (195...253 V AC/DC) - 3 mA	52041	6652041

Utilization category	CCC
AC-12	6 A (24/110/230 V AC)
AC-15	3 A (24/110/230 V AC)
DC-13	1 A (24 V DC); 0.2 A (110 V DC); 0.1 A (230 V DC)

Input	LED display
LED display	LED (yellow)
Output	
Switching voltage	max. 30 V AC/36 V DC
Switching current per output	max. 6 A
Switching current per output (Signal)	max. 20 mA
Min. load current	1 mA (12 V DC)
Power rating (voltage dependent)	max. 1 500 VA/120 W
Switching frequency	max. 10 Hz
Contact material	Ag Sn O2 hv
Energize/release/contact bounce time	10/15/1.5 ms

General data	
Mech./ elect. life	20 000 000 switching cycles/load dependent
Test isolation voltage	4 kV; safe separation (EN 60947-1)
Mounting method	DIN-rail mountable (EN 60715)
Temperature range	-20...+55 °C

## Dimension drawing

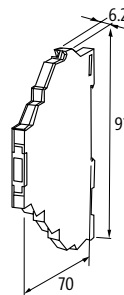
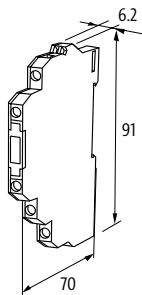

Notes	For inductive loads we recommend EMC suppressors connected parallel to the coil. When the max. switching voltage/current is exceeded the gold plating is destroyed. The relay will then take on the properties of an output type.
-------	---

# RELAYS / SAFETY RELAYS

## Terminal relay

– with bridge system

### MIRO 12.4

Output relay  
2 NO/NC contacts  
Screw terminals



### MIRO 12.4

Output relay  
2 NO/NC contacts  
Spring clamp terminals



### MIRO 12.4

Input relay  
2 NO/NC contacts  
Screw terminals



### MIRO 12.4

Input relay  
2 NO/NC contacts  
Spring clamp terminals



Approvals: **ULus**

## Circuit diagram

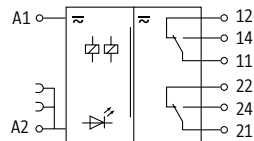

## Order Data

	Art-No.	Art-No.	Art-No.	Art-No.
24 V DC (19.2...30 V DC) - 18 mA	cCSAus, CCC <b>52102</b>	cCSAus, CCC <b>6652102</b>	CCC <b>52110</b>	CCC <b>6652110</b>
24 V AC/DC (19.2...30 V AC/DC) - 20 mA	CCC <b>52103</b>	CCC <b>6652103</b>	CCC <b>52111</b>	CCC <b>6652111</b>
110 V AC/DC (95...121 V AC/DC) - 7 mA	CCC <b>52130</b>	CCC <b>6652130</b>	CCC <b>52136</b>	CCC <b>6652136</b>
230 V AC/DC (195...253 V AC/DC) - 5 mA	CCC <b>52140</b>	CCC <b>6652140</b>	CCC <b>52146</b>	CCC <b>6652146</b>

## Utilization category

AC-12	6 A (24/110/230 V AC)
AC-15	3 A (24/110/230 V AC)
DC-13	1 A (24 V DC); 0.2 A (110 V DC); 0.1 A (230 V DC)

## Input

LED display	LED (green)
-------------	-------------

## Output

Switching voltage	max. 250 V AC/DC	max. 30 V AC/36 V DC
Switching current per output	max. 6 A	
Switching current per output (Signal)	–	max. 20 mA
Min. load current	100 mA (12 V DC)	1 mA (12 V DC)
Power rating (voltage dependent)	max. 1 500 VA/120 W	
Switching frequency	max. 10 Hz	
Contact material	Ag Sn O2	Ag Sn O2 hv
Energize/release/contact bounce time	10/15/1.5 ms	

## General data

Mech./ elect. life	20 000 000 switching cycles/load dependent
Test isolation voltage	4 kV; safe separation (EN 60947-1)
Mounting method	DIN-rail mountable (EN 60715)
Temperature range	-20...+55 °C

## Dimension drawing

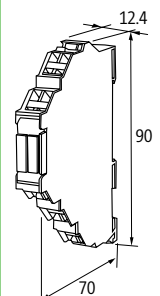
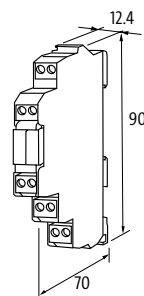
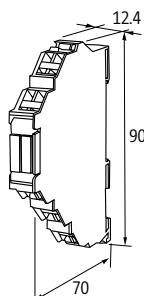
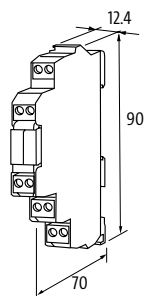

## Notes

For inductive loads we recommend EMC suppressors connected parallel to the coil.



# RELAYS / SAFETY RELAYS

**Terminal relay**  
**– with bridge system**

**MIRO 12.4**  
 Output relay  
 2 NO contact  
 Screw terminals



**MIRO 12.4**  
 Output relay  
 2 NO contact  
 Spring clamp terminals



**MIRO 12.4**  
 Output relay  
 2 NO contact  
 Screw terminals



**MIRO 12.4**  
 Output relay  
 2 NO contact  
 Spring clamp terminals



Approvals:

**Circuit diagram**

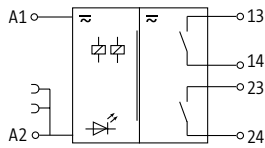

Order Data	Art-No.	Art-No.	Art-No.	Art-No.
24 V AC/DC (19.2...30 V AC/DC) - 20 mA	52104	6652104		
24 V AC/DC (19.2...30 V AC/DC) - 16 mA			52106	6652106

Utilization category	
AC-12	6 A (24/110/230 V AC)
AC-15	3 A (24/110/230 V AC)
DC-13	1 A (24 V DC); 0.2 A (110 V DC); 0.1 A (230 V DC)

Input	
LED display	LED (green)
Output	
Switching voltage	max. 250 V AC/DC
Switching current per output	max. 6 A
Min. load current	100 mA (12 V DC)
Power rating (voltage dependent)	max. 1 500 VA/120 W
Switching frequency	max. 10 Hz
Contact material	Ag Sn O2
Energize/release/contact bounce time	10/15/1.5 ms

General data	
Mech./ elect. life	20 000 000 switching cycles/load dependent
Test isolation voltage	4 kV; safe separation (EN 60947-1)
Mounting method	DIN-rail mountable (EN 60715)
Temperature range	-20...+55 °C

Dimension drawing				

Notes	
	For inductive loads we recommend EMC suppressors connected parallel to the coil.

# RELAYS / SAFETY RELAYS

## Terminal relay

### MIRO 12.4 Multi voltage

Output relay  
1 NO/NC contact  
Screw terminals



Approvals: 

#### Circuit diagram

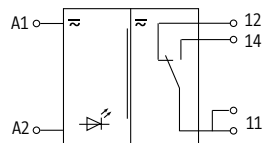

#### Order Data

	Art-No.
24 V AC/DC - 6...27 mA	52160
48 V DC - 6...27 mA	52160
110 V AC/DC - 6...27 mA	52160
230 V AC/DC - 6...27 mA	52160

#### Utilization category

AC-12	6 A (24/110/230 V AC)
AC-15	3 A (24/110/230 V AC)
DC-13	1 A (24 V DC); 0.2 A (110 V DC); 0.1 A (230 V DC)

#### Input

LED display	LED (green)
-------------	-------------

#### Output

Switching voltage	max. 250 V AC/DC
Switching current per output	max. 6 A
Min. load current	10 mA (12 V DC)
Power rating (voltage dependent)	max. 1 500 VA/120 W
Switching frequency	max. 10 Hz
Contact material	Ag Sn O <sub>2</sub>
Energize/release/contact bounce time	10/15/1.5 ms

#### General data

Mech./ elect. life	20 000 000 switching cycles/load dependent
Test isolation voltage	4 kV; safe separation (EN 60947-1)
Mounting method	DIN-rail mountable (EN 60715)
Temperature range	-20...+55 °C

#### Dimension drawing

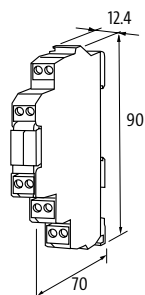

#### Notes

For inductive loads we recommend EMC suppressors connected parallel to the coil.

# RELAYS / SAFETY RELAYS

## Relays

- Screw terminals
- with minus plug link

### RMM

Output relay  
1 relay; 1 NO contact



### RMM

Output relay  
1 relay; 1 NC contact

### Circuit diagram

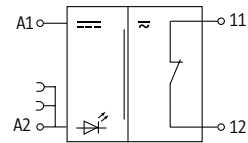
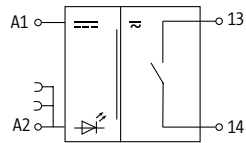

<b>Order Data</b>		<b>Art-No.</b>	<b>Art-No.</b>
24 V AC/DC (19.2...30 V AC/DC) - 15 mA		51851	51808
<b>Utilization category</b>			
AC-1	5 A (24/110/230 V AC)		
AC-15	3 A (24/110/230 V AC)		
DC-13	1.5 A (24 V DC); 0.3 A (110 V DC); 0.15 A (230 V DC)		1.3 A (24 V DC); 0.3 A (110 V DC); 0.15 A (230 V DC)
<b>Input</b>			
Plug link (supplied)	Art.-No. 90960		
LED display	LED (red)		
<b>Output</b>			
Switching voltage	max. 250 V AC/300 V DC		
Switching current per output	max. 5 A		
Min. load current	100 mA		
Power rating (voltage dependent)	max. 1 250 VA/240 W		
Switching frequency	max. 10 Hz		
Contact material	Ag Ni 0.15 hv		
Energize/release/contact bounce time	10/15/1.5 ms		
<b>General data</b>			
Mech./ elect. life	10 000 000 switching cycles/load dependent		20 000 000 switching cycles/load dependent
Test isolation voltage	4 kV		
Mounting method	DIN-rail mountable TH35 or G32 (EN 60715)		
Temperature range	-20...+60 °C		
<b>Dimension drawing</b>			

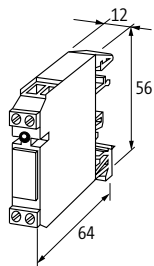

### Notes

# RELAYS / SAFETY RELAYS

## Relays

### – Screw terminals

#### RMM

Output relay  
1 relay; 1 NO contact



#### RMM

Output relay  
1 relay; 1 NC contact

### Circuit diagram

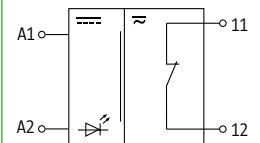
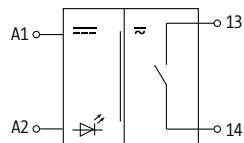

### Order Data

	Art-No.	Art-No.	Art-No.	Art-No.
24 V AC/DC (19.2...30 V AC/DC) - 15 mA	51551	512764		51508
110 V AC/DC (95...121 V AC/DC) - 3.5 mA			51552	
230 V AC/DC (195...250 V AC/DC) - 3.5 mA			51515	
230 V AC/DC (195...250 V AC/DC) - 4 mA				51562

### Utilization category

AC-12	–	6 A (24/110/230 V AC)	5 A (24/110/230 V AC)
AC-1	5 A (24/110/230 V AC)	–	
AC-15	3 A (24/110/230 V AC)		4 A (24/110/230 V AC)
DC-13	1.5 A (24 V DC); 0.3 A (110 V DC); 0.15 A (230 V DC)	1 A (24 V DC); 0.2 A (110 V DC); 0.1 A (230 V DC)	2 A (24 V DC); 0.25 A (110 V DC); 0.1 A (230 V DC)
			3 A (24/110/230 V AC)
			1.3 A (24 V DC); 0.3 A (110 V DC); 0.15 A (230 V DC)

### Input

LED display	LED (red)	LED (green)	LED (red)
-------------	-----------	-------------	-----------

### Output

Switching voltage	max. 250 V AC/300 V DC
Switching current per output	max. 5 A
Min. load current	100 mA
Power rating (voltage dependent)	max. 1 250 VA/240 W
Switching frequency	max. 10 Hz
Contact material	Ag Ni 0.15 hv; Ag hv
Energize/release/contact bounce time	10/15/1.5 ms

### General data

Mech./ elect. life	20 000 000 switching cycles/load dependent
Test isolation voltage	4 kV
Mounting method	DIN-rail mountable TH35 or G32 (EN 60715)
Temperature range	-20...+50 °C

### Dimension drawing

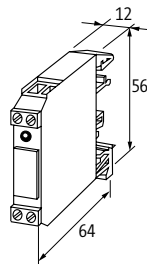

### Notes

# RELAYS / SAFETY RELAYS

## Relays

### – Screw terminals

#### RMME

Input relay  
1 relay; 1 NO contact  
with minus plug link



#### RMME

Input relay  
1 relay; 1 NO contact



#### RMME

Input relay  
1 relay; 1 NC contact

### Circuit diagram

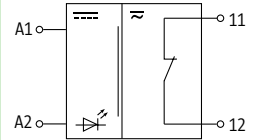
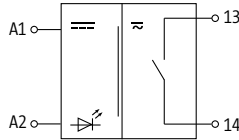
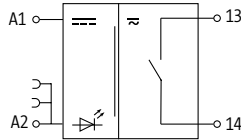

Order Data	Art-No.	Art-No.	Art-No.	Art-No.
24 V AC/DC (21.6...26.4 V AC/DC) - 6 mA	51860			
24 V AC/DC (19.2...30 V AC/DC) - 6 mA		51560		
110 V AC/DC (95...121 V AC/DC) - 3.5 mA		51526		
230 V AC (195...253 V AC) - 6 mA			51517	
24 V AC/DC (19.2...30 V AC/DC) - 15 mA				51571

### Utilization category

AC-15	1 A (24 V AC); 0.5 A (125 V AC)	0.25 A (50 V AC)	3 A (24/110/230 V AC)
DC-13	1 A (24 V DC); 0.5 A (125 V DC)	–	1.5 A (24 V DC); 0.3 A (110 V DC); 0.15 A (230 V DC)
AC-1	–		5 A (24/110/230 V AC)
AC-12	–	0.5 A (50 V AC)	–

### Input

Plug link (supplied)	Art-No. 90960	–
LED display	LED (yellow)	

### Output

Switching voltage	max. 125 V AC/DC
Switching current per output	max. 1 A
Min. load current	1 mA
Power rating (voltage dependent)	max. 60 VA/30 W
Switching frequency	max. 15 Hz
Contact material	Pd Ni-Au Rh
Energize/release/contact bounce time	10/10/1 ms

### General data

Mech./ elect. life	100 000 000 switching cycles/load dependent
Test isolation voltage	1.5 kV
Mounting method	DIN-rail mountable TH35 or G32 (EN 60715)
Temperature range	-20...+60 °C

### Dimension drawing

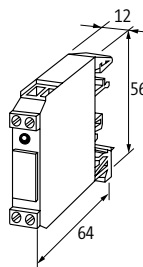
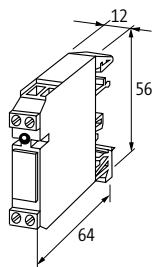

### Notes

# RELAYS / SAFETY RELAYS

## Relays

– with minus plug link

– Screw terminals

### RMMD

Output relay  
1 relay; 1 NO contact



### RMMD

Output relay  
1 relay; 1 NO/NC contact

### Circuit diagram

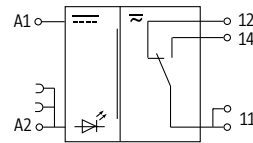
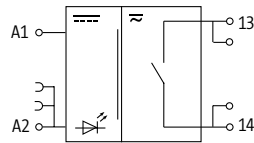

### Order Data

	Art-No.	Art-No.	Art-No.	Art-No.
24 V DC (21.6...26.4 V DC) - 13.5 mA	51100			
230 V AC/DC (195...253 V AC/DC) - 4.5 mA		51108		
24 V DC (21.6...26.4 V DC) - 15 mA			51120	
24 V AC/DC (19.2...30 V AC/DC) - 10 mA				51125

### Utilization category

AC-1	8 A (24/110/230 V AC)	6 A (24/110/230 V AC)	8 A (24/110/230 V AC)
AC-15	3 A (24/110/230 V AC)	4 A (24/110/230 V AC)	3 A (24/110/230 V AC)
DC-13	2.5 A (24 V DC); 0.4 A (110 V DC); 0.3 A (230 V DC)	2 A (24 V DC); 0.25 A (110 V DC); 0.1 A (230 V DC)	2.5 A (24 V DC); 0.4 A (110 V DC); 0.3 A (230 V DC)

### Input

Plug link (supplied)	Art.-No. 90960	–	Art.-No. 90960
LED display	LED (red)		

### Output

Switching voltage	max. 250 V AC/DC		
Switching current per output	max. 8 A	max. 6 A	max. 8 A
Min. load current	100 mA		
Power rating (voltage dependent)	max. 2 000 VA/240 W		
Switching frequency	max. 10 Hz		
Contact material	Ag Ni		
Energize/release/contact bounce time	10/15/2 ms		

### General data

Mech./ elect. life	20 000 000 switching cycles/load dependent		
Test isolation voltage	5 kV; safe separation (IEC 61140/EN 61140)	4 kV	5 kV; safe separation (IEC 61140/EN 61140)
Temperature range	-20...+50 °C		
Mounting method	DIN-rail mountable TH35 or G32 (EN 60715)		

### Dimension drawing

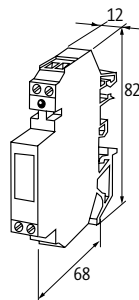

### Notes

Art.-No. 51125 with low connection current.

# RELAYS / SAFETY RELAYS

## Relays

- with minus plug link
- with bridge system
- Screw terminals

### RMMDE

Input relay  
1 relay; 1 NO contact/1 NC contact



### RMMDE

Input relay  
1 relay; 1 NO/NC contact

### RMMDE

Input relay  
1 relay; 2 NO contacts

### Circuit diagram

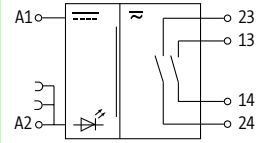
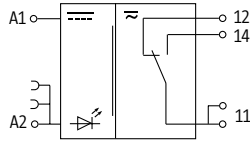
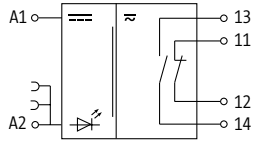

Order Data	Art-No.	Art-No.	Art-No.	Art-No.
24 V DC (17.5...30 V DC) - 14 mA	516014			
24 V DC (19.2...30 V DC) - 17 mA		51130		
230 V AC/DC (195...253 V AC/DC) - 4.5 mA			51138	
24 V DC (19.2...30 V DC) - 15 mA				51140
Utilization category				
AC1	3 A (24 V AC); 2 A (230 V AC)	5 A (24/110/230 V AC)		2 A (24 V AC; 110 V AC; 230 V AC)
AC15	1 A (24 V AC); 0.1 A (230 V AC)	3 A (24/110/230 V AC)	4 A (24/110/230 V AC)	1 A (24 V AC); 0.1 A (230 V AC)
DC13	0.8 A (24 V DC); 0.01 A (230 V DC)	1.3 A (24 V DC); 0.25 A (110 V DC); 0.10 A (230 V DC)	2 A (24 V DC); 0.25 A (110 V DC); 0.1 A (230 V DC)	0.8 A (24 V DC); 0.1 A (110 V DC); 0.01 A (230 V DC)
Input				
Plug link (supplied)	Art-No. 90960		-	Art-No. 90960
LED display	LED (red)	LED (yellow)		
Output				
Switching voltage	max. 250 V AC/DC			
Switching current per output	max. 3 A	max. 20 mA	max. 5 A	max. 2 A
Min. load current	1 mA			5 mA
Power rating (voltage dependent)	max. 500 VA/180 W	max. 1 500 VA/180 W		max. 250 VA/150 W
Switching frequency	max. 10 Hz	max. 15 Hz		
Contact material	Ag Ni 0.15 hv	Ag Ni 0.15 hv; Ag hv		Ag Au
Energize/release/contact bounce time	6/3/2 ms	10/10/1 ms		
General data				
Mech./ elect. life	20 000 000 switching cycles/load dependent	100 000 000 switching cycles/load dependent		20 000 000 switching cycles/load dependent
Test isolation voltage	2.5 kV	4 kV		1.5 kV
Mounting method	DIN-rail mountable TH35 or G32 (EN 60715)			
Temperature range	-20...+60 °C			-20...+50 °C
Dimension drawing				
Notes				

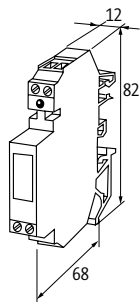

# RELAYS / SAFETY RELAYS

## Relays

### – Screw terminals

#### RM

Output relay  
1 relay; 2 NO/NC contacts



#### RM

Output relay  
1 relay; 4 NO/NC contacts

#### RM

Output relay  
2 relays; each 1 NO/NC contact

#### RM

Output relay  
2 relays; each 2 NO/NC contacts

### Circuit diagram

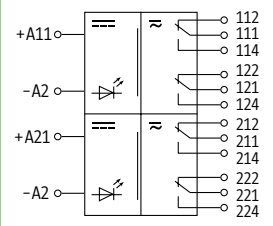
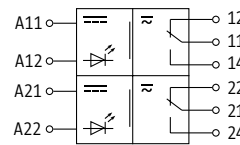
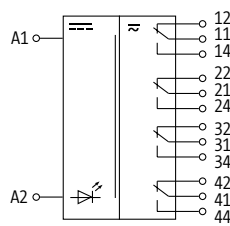
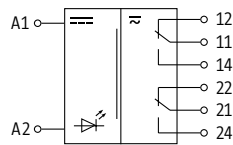

Order Data	Art-No.	Art-No.	Art-No.	Art-No.
24 V AC/DC (20.4...26.4 V AC/DC) - 20 mA	51540	51410		
230 VAC (195...250 VAC) - 10 mA		51413	51412	
24 V AC/DC (19.2...30 V AC/DC) - 10 mA			51485	
24 V AC/DC (19.2...30 V AC/DC) - 14 mA				51465

### Utilization category

AC-1	8 A (24/110/230 V AC)	–	8 A (24/110/230 V AC)	
AC-12	–	2 A (24 V AC); 0.5 A (230 V AC)	–	
AC-15	3 A (24/110/230 V AC)	1 A (24 V AC); 0.1 A (230 V AC)	3 A (24/110/230 V AC)	
DC-13	2 A (24 V DC); 0.3 A (110 V DC); 0.2 A (230 V DC)	0.8 A (24 V DC); 0.01 A (230 V DC)	1.5 A (24 V DC); 0.3 A (110 V DC); 0.15 A (230 V DC)	2 A (24 V DC); 0.3 A (110 V DC); 0.2 A (230 V DC)

Input				
LED display	LED (red)			

### Output

Switching voltage	max. 250 V AC/DC			
Switching current per output	max. 8 A	max. 2 A	max. 8 A	
Min. load current	100 mA	0.1 mA	100 mA	
Power rating (voltage dependent)	max. 1 250 VA/240 W	max. 125 VA/60 W	max. 1 250 VA/240 W	
Switching frequency	max. 0.1 Hz (with load)			
Contact material	Ag Ni 0.15 hv	Ag Au	Ag Sn O2	Ag Ni 0.15 hv
Energize/release/contact bounce time	10/10/2 ms	10/20/2 ms	10/10/2 ms	

### General data

Mech./ elect. life	50 000 000 switching cycles/load dependent		20 000 000 switching cycles/load dependent	
Test isolation voltage	4 kV	1.5 kV	4 kV	
Mounting method	DIN-rail mountable TH35 or G32 (EN 60715)			
Temperature range	-20...+50 °C			

### Dimension drawing

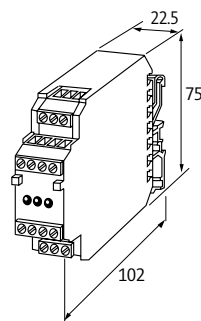

### Notes



# RELAYS / SAFETY RELAYS

## Relays

- Screw terminals
- with force guided contacts

### RM

Output relay  
1 relay; 2 NO contacts/2 NC contacts



### RM

Output relay  
1 relay; 3 NO contacts/1 NC contact

### MKS

Output relay  
1 relay; 1 NO contact/1 NC contact



## Circuit diagram

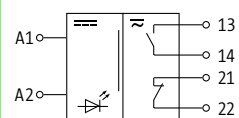
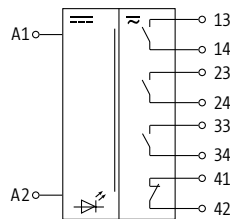
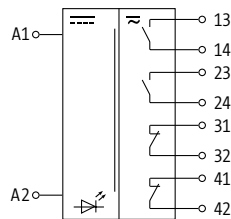

Order Data	Art-No.	Art-No.	Art-No.
24 V DC (21.6...28 V DC) - 29 mA	51300		
24 V DC (21.6...28 V DC) - 30 mA			51301
24 V AC/DC (21.6...28 V AC/DC) - 38 mA			51302
Utilization category			
AC-1	5 A (24/110/230 V AC)		6 A (24/110/230 V AC)
DC-13	2 A (24 V DC); 0.4 A (110 V DC); 0.2 A (230 V DC)		3 A (24 V DC); 0.22 A (110 V DC); 0.1 A (230 V DC)
AC-15	4 A (24 V AC); 3 A (110 V AC); 2 A (230 V AC)		3 A (24/110/230 V AC)
Input			
LED display	LED (red)		LED (green)
Output			
Switching voltage	max. 250 V AC/DC		
Switching current per output	max. 5 A		max. 6 A
Min. load current	300 mA		10 mA
Power rating (voltage dependent)	max. 1 000 VA/50 W		max. 1 500 VA/100 W
Switching frequency	max. 0.1 Hz (with load)	max. 1 Hz	max. 5 Hz
Contact material	Ag Ni 10 hv	Ag hv; Ag Sn O2	Ag Ni 10 hv
Energize/release/contact bounce time	15/15/2 ms		15/15/1.5 ms
General data			
Mech./ elect. life	1 000 000 switching cycles/load dependent		10 000 000 switching cycles/load dependent
Test isolation voltage	2.5 kV		4 kV
Mounting method	DIN-rail mountable TH35 or G32 (EN 60715)		
Temperature range	-20...+50 °C		

## Dimension drawing

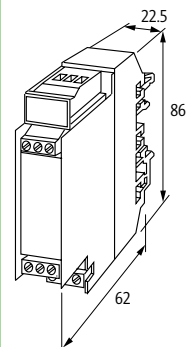
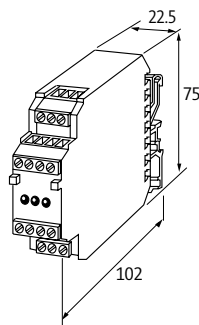

## Notes

# RELAYS / SAFETY RELAYS

## Relays

### – Screw terminals

#### RM

Output relay  
3 relays; each 1 NO/NC contact



#### RM

Output relay  
4 relays; each 1 NO contact

### Circuit diagram

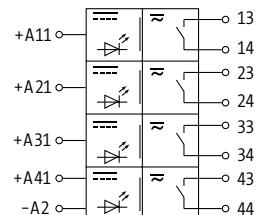
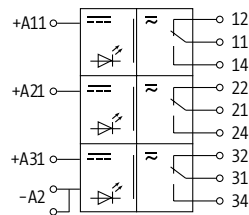

### Order Data

24 V DC (19.2...30 V DC) - 16 mA

### Art-No.

51403

### Art-No.

512498

### Utilization category

AC-1 8 A (24/110/230 V AC)  
AC-15 3 A (24/110/230 V AC)  
DC-13 1.5 A (24 V DC); 0.3 A (110 V DC); 0.15 A (230 V DC)

5 A (24/110/230 V AC)

### Input

LED display LED (red)

### Output

Switching voltage max. 250 V AC/DC  
Switching current per output max. 8 A | max. 5 A  
Min. load current 100 mA  
Power rating (voltage dependent) max. 1 250 VA/240 W  
Switching frequency max. 0.1 Hz (with load)  
Contact material Ag Sn O2 | Ag hv  
Energize/release/contact bounce time 10/10/2 ms

### General data

Mech./ elect. life 20 000 000 switching cycles/load dependent | 50 000 000 switching cycles/load dependent  
Test isolation voltage 4 kV  
Mounting method DIN-rail mountable TH35 or G32 (EN 60715)  
Temperature range -20...+50 °C

### Dimension drawing

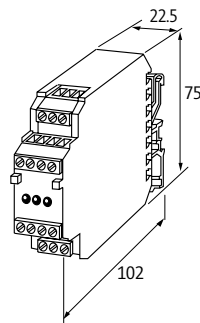

### Notes

# RELAYS / SAFETY RELAYS

## Safety relay

– Protection-door and emergency-stop control

Approvals:  Listed

### MIRO SAFE+ Switch H 48-230

with/without start button monitoring



#### Circuit diagram

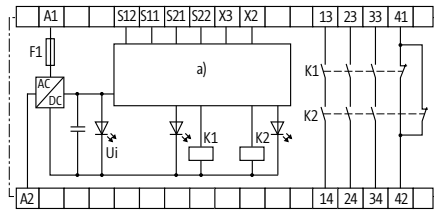

<b>Order Data</b>		<b>Art-No.</b>
3 safety contacts		<b>3000-33113-1020012</b>
<b>Utilization category</b>		
Safety contacts (STOPO)	max. 250 V AC/6 A; min. 10 V AC/10 mA (ohm./ind.), at suitable suppression	
AC-15	6 A (230 V AC) STOPO	
DC-13	6 A (24 V DC) STOPO	
<b>Safety Indicators</b>		
PL	up to e	
Category	up to 4	
DC	99%	
SIL	up to 3	
Service life	20 years	
<b>Input</b>		
Input voltage	48...240 V AC	
Input current	max. 2.8 VA	
<b>Output</b>		
Switching voltage	max. 250 V AC/DC	
Switching current per output	max. 6 A	
Number of auxiliary contacts	1 - (41-42)	
Number of alarm outputs	0	
Number of safety contacts	3 - (13-14); (23-24); (33-34)	
Contact material	AgSnO, self cleaning, positively driven	
<b>General data</b>		
Mech./ elect. life	10 000 000 switching cycles/load dependent	
Connection	Spring clamp plug-in terminals	
Mounting method	DIN-rail mountable (EN 60715)	
Temperature range	-25...+45 °C (storage temperature -40...+85 °C)	
<b>Dimension drawing</b>		

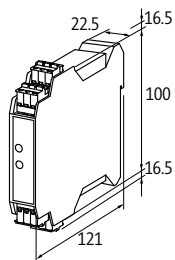

#### Notes

# RELAYS / SAFETY RELAYS

## Safety relay

- Protection-door and emergency-stop control
- Light curtain control
- Safety magnetic switch control

Approvals:  

## MIRO SAFE+ Switch H L 24

with/without start button monitoring



### Circuit diagram

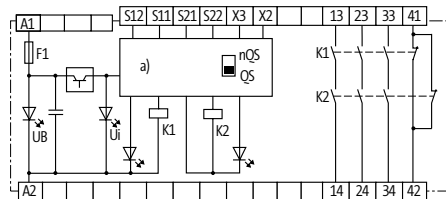

### Order Data

3 safety contacts

### Art-No.

3000-33113-3020012

### Utilization category

Safety contacts (STOPO)

max. 250 V AC/8 A; min. 10 V AC/10 mA (ohm./ind.), at suitable suppression

AC-15

6 A (230 V AC) STOPO

DC-13

6 A (24 V DC) STOPO

### Safety Indicators

PL

up to e

Category

up to 4

DC

99%

SIL

up to 3

Service life

20 years

### Input

Input voltage

24 V DC (-15 +20%), 24 V AC (-15 +10%)

Input current

max. 4.9 VA/2.0 W

### Output

Switching voltage

max. 250 V AC/DC

Switching current per output

max. 8 A

Total current

24 A (45 °C); 18 A (55 °C); 12 A (60 °C)

Number of auxiliary contacts

1 - (41-42)

Number of alarm outputs

0

Number of safety contacts

3 - (13-14); (23-24); (33-34)

Contact material

AgSnO, self cleaning, positively driven

### General data

Mech./ elect. life

10 000 000 switching cycles/load dependent

Connection

Spring clamp plug-in terminals

Mounting method

DIN-rail mountable (EN 60715)

Temperature range

-25...+60 °C (storage temperature -40...+85 °C)

### Dimension drawing

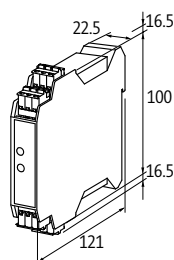

### Notes

## RELAYS / SAFETY RELAYS

### Safety relay

- Protection-door and emergency-stop control
- Light curtain control
- Safety magnetic switch control

### MIRO SAFE+ Switch ECOA 24

without start button monitoring



### Circuit diagram

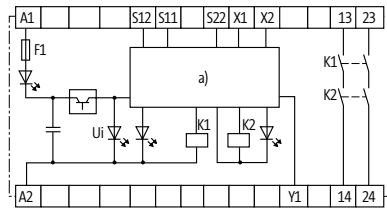

<b>Order Data</b>		<b>Art-No.</b>
2 safety contacts		<b>3000-33113-3020005</b>
<b>Utilization category</b>		
Safety contacts (STOP 0)	max. 250 V AC/4 A; min. 5 V AC/1 mA (ohm./ind.), at suitable suppression	
AC-15	2 A (230 V AC) STOPO	
DC-13	1 A (24 V DC) STOPO	
Alarm outputs	100 mA (24 V DC)	
<b>Safety Indicators</b>		
PL	up to 4	
Category	–	
DC	–	
SIL	–	
Service life	–	
<b>Input</b>		
Input voltage	24 V DC (-15 +20%), 24 V AC (-15 +10%)	
Input current	max. 5.2 VA/2.0 W	
<b>Output</b>		
Switching voltage	max. 250 V AC/DC	
Switching current per output	max. 4 A	
Number of auxiliary contacts	0	
Number of alarm outputs	1 - (Y1)	
Number of safety contacts	2 - (13-14; 23-24)	
Contact material	AgSnO, self cleaning, positively driven	
<b>General data</b>		
Mech./ elect. life	10 000 000 switching cycles/load dependent	
Connection	Screw terminals	
Mounting method	DIN-rail mountable (EN 60715)	
Temperature range	-25...+60 °C (storage temperature -40...+85 °C)	
<b>Dimension drawing</b>		

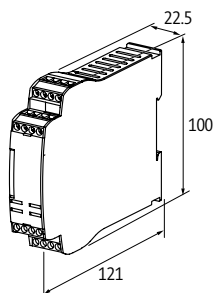

### Notes

## RELAYS / SAFETY RELAYS

### Safety relay

- Protection-door and emergency-stop control
- Light curtain control
- Safety magnetic switch control

Approvals:  UL<sub>US</sub>  
Listed

### MIRO SAFE+ Switch BA L 24

without start button monitoring



### MIRO SAFE+ Switch BCS L 24

with start button monitoring



### Circuit diagram

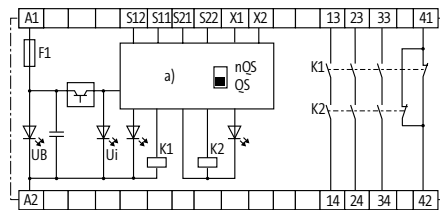

Order Data	Art-No.	Art-No.
3 safety contacts	3000-33113-3020025	3000-33113-3020020
<b>Utilization category</b>		
Safety contacts (STOPO)	max. 250 V AC/8 A; min. 10 V AC/10 mA (ohm./ind.), at suitable suppression	
AC-15	6 A (230 V AC) STOPO	
DC-13	6 A (24 V DC) STOPO	
<b>Safety Indicators</b>		
PL	up to e	
Category	up to 4	
DC	99%	
SIL	up to 3	
Service life	20 years	
<b>Input</b>		
Input voltage	24 V DC (-15 +20%), 24 V AC (-15 +10%)	
Input current	max. 4.9 VA/2.0 W	max. 4.4 VA/1.8 W
<b>Output</b>		
Switching voltage	max. 250 V AC/DC	
Switching current per output	max. 8 A	
Total current	24 A (45 °C); 18 A (55 °C); 12 A (60 °C)	
Number of auxiliary contacts	1 - (41-42)	
Number of alarm outputs	0	
Number of safety contacts	3 - (13-14); (23-24); (33-34)	
Contact material	AgSnO, self cleaning, positively driven	
<b>General data</b>		
Mech./ elect. life	10 000 000 switching cycles/load dependent	
Connection	Screw terminals	
Mounting method	DIN-rail mountable (EN 60715)	
Temperature range	-25...+60 °C (storage temperature -40...+85 °C)	

### Dimension drawing

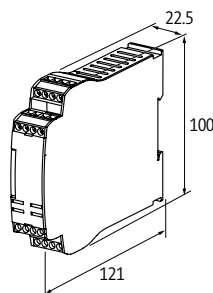

### Notes

# RELAYS / SAFETY RELAYS

## Safety relay

- Protection-door and emergency-stop control
- Light curtain control
- Safety magnetic switch control

Approvals:  Listed

### MIRO SAFE+ T 1 24

with/without start button monitoring



### MIRO SAFE+ T 2 24

with/without start button monitoring



## Circuit diagram

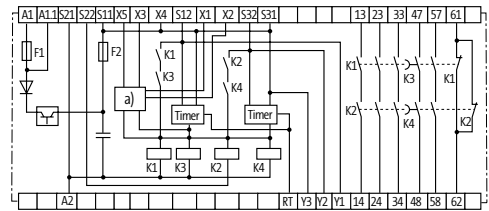
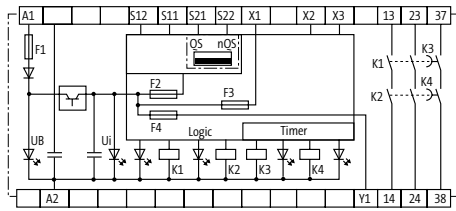

Order Data	Art-No.	Art-No.
3 safety contacts	3000-33113-3020065	
5 safety contacts		3000-33113-3020060
<b>Utilization category</b>		
Safety contacts (STOP 0)	max. 250 V AC/8 A; min. 5 V AC/5 mA (ohm./ind.), at suitable suppression	max. 250 V AC/8 A; min. 10 V AC/10 mA (ohm./ind.), at suitable suppression
Safety contacts (STOP 1)	max. 250 V AC/6 A; min. 10 V AC/10 mA (ohm./ind.), at suitable suppression	
AC-15	6 A (230 V AC) STOP0; 3 A (230 V AC) STOP1	
DC-13	5 A (24 V DC) STOP0; 2 A (24 V DC) STOP1	6 A (24 V DC) STOP0; 2 A (24 V DC) STOP1
<b>Safety Indicators</b>		
PL	up to e (STOP0); up to d (STOP1)	
Category	up to 4 (STOP0); up to 3 (STOP1)	
DC	99% (STOP0); min. 60% (STOP1)	
SIL	up to 3 (STOP0); up to 2 (STOP1)	
Service life	20 years	
<b>Input</b>		
Input voltage	24 V DC (-15 +20%), 24 V AC (-15 +10%)	
Input current	5.9 VA/2.4 W (with monitoring output)	max. 7.1 VA/3.2 W (with monitoring output)
<b>Output</b>		
Switching voltage	max. 250 V AC/DC	
Switching current per output	max. 8 A (STOP0); max. 6 A (STOP1)	max. 6 A
Number of auxiliary contacts	0	1 - (31-32)
Total current (STOP 0)	–	18 A (45 °C); 15 A (55 °C); 12 A (60 °C)
Number of alarm outputs	1 - (Y1)	3 - (13-14); (23-24); (33-34)
Total current (STOP 1)	–	12 A (45 °C); 10 A (55 °C); 8 A (60 °C)
Number of safety contacts	2 - (13-14), (23-24), STOP0; 1 - (37-38), STOP1	3 - (13-14), (23-24), (33-34), STOP0; 2 - (47-48), (57-58), STOP1
Contact material	AgSnO, self cleaning, positively driven	
<b>General data</b>		
Mech./ elect. life	10 000 000 switching cycles/load dependent	
Connection	Spring clamp plug-in terminals	
Mounting method	DIN-rail mountable (EN 60715)	
Temperature range	-25...+60 °C (storage temperature -40...+85 °C)	
<b>Dimension drawing</b>		

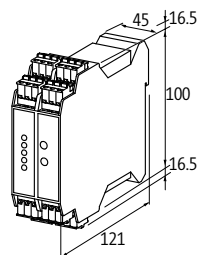
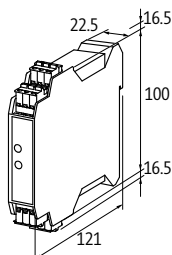

# RELAYS / SAFETY RELAYS

## Safety relay

– Two hand control

### MIRO SAFE+ HAND 24

without start button monitoring



Approvals:  UL<sup>®</sup> Listed

#### Circuit diagram

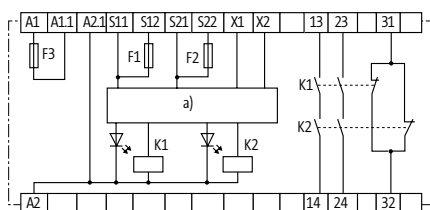

#### Order Data

2 safety contacts

#### Art-No.

3000-33113-3020030

#### Utilization category

Safety contacts (STOPO)

max. 250 V AC/6 A; min. 10 V AC/10 mA (ohm./ind.), at suitable suppression

AC-15

6 A (230 V AC) STOPO

DC-13

6 A (24 V DC) STOPO

#### Safety Indicators

PL

up to e

Category

up to 4

DC

99%

SIL

up to 3

Service life

20 years

#### Input

Input voltage

24 V DC  $\pm 10\%$

Input current

max. 1.2 W

#### Output

Switching voltage

max. 250 V AC/DC

Switching current per output

max. 6 A

Number of auxiliary contacts

1 - (31-32)

Number of alarm outputs

0

Number of safety contacts

2 - (13-14); (23-24)

Contact material

AgSnO, self cleaning, positively driven

#### General data

Mech./ elect. life

10 000 000 switching cycles/load dependent

Connection

Spring clamp plug-in terminals

Mounting method

DIN-rail mountable (EN 60715)

Temperature range

-25...+60 °C (storage temperature -40...+85 °C)

#### Dimension drawing

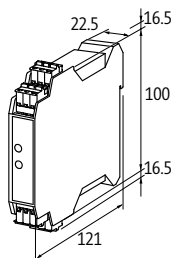

#### Notes



# RELAYS / SAFETY RELAYS

## Safety relay

- Protection-door control
- Pressure-sensitive mat. control

Approvals:  Listed

**MIRO SAFE+ STEP 24**  
without start button monitoring



### Circuit diagram

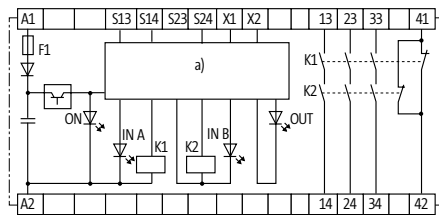

<b>Order Data</b>		<b>Art-No.</b>
3 safety contacts		<b>3000-33113-3020050</b>
<b>Utilization category</b>		
Safety contacts (STOPO)	max. 250 V AC/8 A; min. 10 V AC/10 mA (ohm./ind.), at suitable suppression	
AC-15	6 A (230 V AC) STOPO	
DC-13	6 A (24 V DC) STOPO	
<b>Safety Indicators</b>		
PL	up to e	
Category	up to 4	
DC	99%	
SIL	up to 3	
Service life	20 years	
<b>Input</b>		
Input voltage	24 V DC (-15 +20%), 24 V AC (-15 +10%)	
Input current	max. 3.7 VA/1.6 W (24 V DC)	
<b>Output</b>		
Switching voltage	max. 250 V AC/DC	
Switching current per output	max. 8 A	
Number of auxiliary contacts	1 - (41-42)	
Number of alarm outputs	0	
Number of safety contacts	3 - (13-14); (23-24); (33-34)	
Contact material	AgSnO, self cleaning, positively driven	
<b>General data</b>		
Mech./ elect. life	10 000 000 switching cycles/load dependent	
Connection	Spring clamp plug-in terminals	
Mounting method	DIN-rail mountable (EN 60715)	
Temperature range	-25...+60 °C (storage temperature -40...+85 °C)	
<b>Dimension drawing</b>		

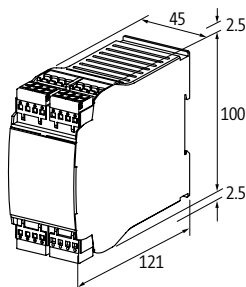

### Notes

# RELAYS / SAFETY RELAYS

## Expansion modules

### MIRO SAFE+ E 24

Expansion module



Approvals:  **UL** us  
Listed

### Circuit diagram

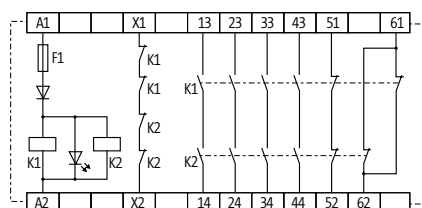

### Order Data

4 NO contacts

Art-No.

3000-33113-3020075

### Utilization category

Safety contacts (STOP 0)

max. 250 V AC/6 A; min. 10 V AC/10 mA (ohm./ind.), at suitable suppression

AC-15

6 A (230 V AC)

DC-13

6 A (24 V DC)

### Safety Indicators

PL

up to e

Category

up to 4

SIL

up to 3

Service life

20 years

### Input

Input voltage

24 V DC (-15 +20%), 24 V AC (-15 +10%)

Input current

max. 1.0 VA

### Output

Switching voltage

max. 250 V AC/DC

Switching current per output

max. 6 A

Number of auxiliary contacts

2 - (51-52); (61-62)

Number of alarm outputs

0

Number of contacts

4 - (13-14); (23-24); (33-34); (43-44)

Contact material

AgSnO, self cleaning, positively driven

### General data

Mech./ elect. life

10 000 000 switching cycles/load dependent

Connection

Spring clamp plug-in terminals

Mounting method

DIN-rail mountable (EN 60715)

Temperature range

-25...+45 °C (storage temperature -40...+85 °C)

### Dimension drawing

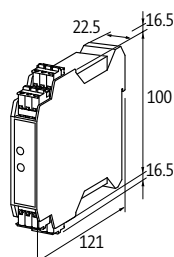

### Notes

## RELAYS / SAFETY RELAYS

Labeling accessories			Art-No.
	<b>ACS label plate (KM 5)</b> for self marking (9 × 20 mm) 5 × 10 mm		7000-99001-000000 90931
	<b>Label plate (KWI 5/15)</b> (88 pieces per plate)		90901
Wiring accessories			Art-No.
	<b>Potential plug link</b> max. 48 V/2 A	RMM..., RMMD...	90960
	<b>Potential plug link</b> max. 50 V/2 A	MIRO	90961
	<b>Potential plug link</b> blue	MIRO 6.2 pluggable	3000-90000-0300010
	<b>Potential plug link</b> black	MIRO 6.2 pluggable	3000-90000-0300020
	<b>Potential rail blue</b> 10-pole, spacing 6.2 mm 40-pole, spacing 12 mm	MIRO 6.2 (screw terminals) RMM..., RMMD...	90975 90970
	<b>Potential rail red</b> 10-pole, spacing 6.2 mm 40-pole, spacing 12 mm	MIRO 6.2 (screw terminals) RMM..., RMMD...	90976 90971
	<b>End caps for potential rail</b> blue	MIRO 6.2 RMM..., RMMD...	90980
	<b>End caps for potential rail</b> red	MIRO 6.2 RMM..., RMMD...	90982

## RELAYS / SAFETY RELAYS

Wiring accessories			Art-No.
	<b>Wire chain 16-pole</b> Connection cable left and right approx. 50 cm; bk; 1 mm <sup>2</sup>	MIRO (spring clamp terminals)	<b>90977</b>
	<b>Double spring clamp terminal</b> pluggable	MIRO SAFE+	<b>3000-33010-0000000</b>



# OPTOCOUPLERS / SEMICONDUCTORS SWITCHING WITHOUT WEAR

- Shortest possible switching times
- High switching frequencies
- Resistant to EMC interference

## MILLIONS OF SWITCHING CYCLES – EVEN WITH HIGH FREQUENCIES

Optocouplers and semiconductors are used to combine different signal levels or to isolate one signal from another. They are similar to a relay interface because they provide an optoelectronic signal transfer between input and output.

Optocouplers and semiconductors have a long life span because they don't have any mechanical components that could wear out. They are suitable for applications with high switching frequencies, even over a long time.

### Some benefits of optocouplers and semiconductors:

- Silent operation
- No contact bounce
- Galvanic separation between input and output
- High resistance to shock and vibration
- High switching currents
- Low input power

---

## Optocouplers / Semiconductors



### Optocouplers

- Pluggable
- DC applications

Page 1.10.1



### Optocouplers

- DC applications

Page 1.10.2



### Semiconductors

- AC applications

Page 1.10.18

## Terminal optocoupler

- pluggable
- with bridge system
- Complete module

### MIRO 6.2

Transistor 6 A  
Spring clamp terminals



## Circuit diagram

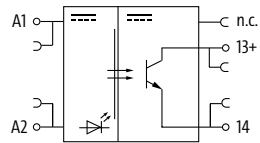

## Order Data

24 V DC (18...30 V DC) - 9 mA

Art-No.

3000-32512-2100040

## Accessories

Removable plug-in module

Art-No.

3000-32522-2100040

## Input

Connection voltage - current 24 V DC (18...30 V DC) - 9 mA

LED display LED (yellow)

## Output

Switching time ON/OFF 15/31  $\mu$ s

Switching voltage 3...30 V DC

Switching current per output 10 mA...6 A

Saturation voltage (across output) max. 240 mV

Switching frequency max. 500/50 Hz (ohm./ind.)

## General data

Test isolation voltage 50 V

Surge voltage resistance 2.5 kV

Protection IP20

Mounting method pluggable

Temperature range -25...+50 °C

## Dimension drawing

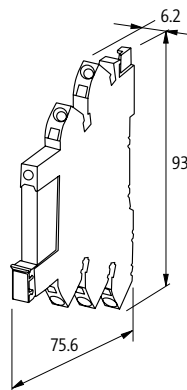

## Notes

# OPTOCOUPLEDERS / SEMICONDUCTORS

## Terminal optocoupler

– with bridge system

### MIRO 6.2

Transistor 1 A  
Screw terminals



### MIRO 6.2

Transistor 1 A  
Spring clamp terminals



### MIRO 6.2

Transistor 2 A  
Screw terminals



### MIRO 6.2

Transistor 2 A  
Spring clamp terminals



## Circuit diagram

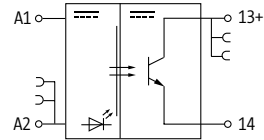
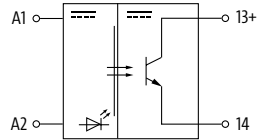

Order Data	Art-No.	Art-No.	Art-No.	Art-No.
24 V DC/6 mA	52515	6652515		
5 V DC/6 mA			cURus, cCSAus	6652502
<b>Input</b>				
Voltage range ON	11...30 V DC		4...5.5 V DC	
Voltage range OFF	0...5 V DC		0...2 V DC	
Control current	6 mA			
LED display	LED (yellow)			
<b>Output</b>				
Switching voltage	3...48 V DC		5...48 V DC	
Switching current per output	500 µA...1 A		1 mA...2 A	
Saturation voltage (across output)	max. 0.12 V DC		max. 0.3 V DC	
Leakage current (output is open)	max. 25 µA		max. 10 µA	
Switching time ON/OFF	1.5/1 ms (100 mA load)		1/5 ms	
Switching frequency	max. 40/4 Hz (resist./ind.)		max. 10/1 Hz (resist./ind.)	
<b>General data</b>				
Test isolation voltage	500 V		2.5 kV	
Mounting method	DIN-rail mountable (EN 60715)			
Housing	Black plastic, flame retardant			
Temperature range	-20...+60 °C			
<b>Dimension drawing</b>				

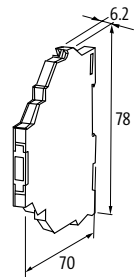
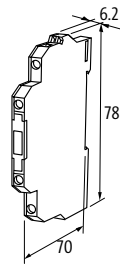
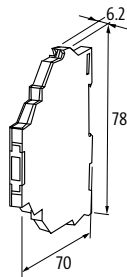
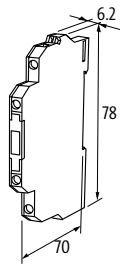

## Notes

## Terminal optocoupler

– with bridge system

### MIRO 6.2

Transistor 2 A  
Screw terminals



### MIRO 6.2

Transistor 2 A  
Spring clamp terminals



### MIRO 6.2

Transistor 0.5 A  
Screw terminals



### MIRO 6.2

Transistor 0.5 A  
Spring clamp terminals



Approvals:

## Circuit diagram

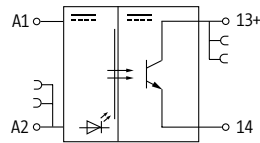

## Order Data

24 V DC/6 mA

Art-No.

52501

Art-No.

6652501

Art-No.

52505

Art-No.

6652505

48 V DC/6 mA

## Input

Voltage range ON

10...48 V DC

Voltage range OFF

0...5 V DC

Control current

6 mA

LED display

LED (yellow)

## Output

Switching voltage

5...48 V DC

Switching current per output

1 mA...2 A

0.1 mA...0.5 A

Saturation voltage (across output)

max. 0.3 V DC

max. 1.2 V DC

Leakage current (output is open)

max. 10 µA

Switching time ON/OFF

1/5 ms

20/100 µs

Switching frequency

max. 10/1 Hz (resist./ind.)

max. 1 kHz/10 Hz (resist./ind.)

## General data

Test isolation voltage

2.5 kV

3.75 kV

Mounting method

DIN-rail mountable (EN 60715)

Housing

Black plastic, flame retardant

Temperature range

-20...+60 °C

## Dimension drawing

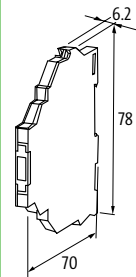
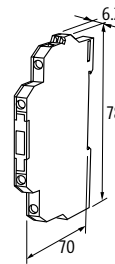
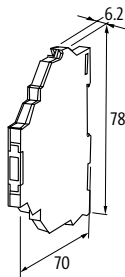
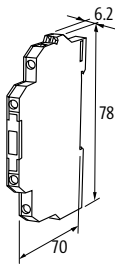

## Notes



# OPTOCOUPLEDERS / SEMICONDUCTORS

Terminal optocoupler  
– with bridge system

**MIRO 6.2**  
Transistor 6 A  
Screw terminals



**MIRO 6.2**  
Transistor 6 A  
Spring clamp terminals



**MIRO 6.2**  
Transistor 10 A  
Screw terminals



**MIRO 6.2**  
Transistor 10 A  
Spring clamp terminals



Approvals: 

## Circuit diagram

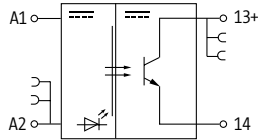

Order Data	Art-No.	Art-No.	Art-No.	Art-No.
24 V DC/6 mA	cURus	52519	6652519	
24 V DC/10 mA			cURus	52520
				6652520

Input		
Voltage range ON	10...53 V DC	
Voltage range OFF	0...5 V DC	
Control current	approx. 10 mA	10 mA
LED display	LED (yellow)	
Output		
Switching voltage	5...48 V DC	
Switching current per output	1 mA...6 A (without derating)	1 mA...10 A
Saturation voltage (across output)	max. 0.1 V DC	max. 0.12 V DC
Leakage current (output is open)	max. 25 µA	
Switching time ON/OFF	2/5 ms	2/5 ms (10 A load)
Switching frequency	max. 1/0.1 Hz (resist./ind.)	
General data		
Test isolation voltage	2.75 kV	
Mounting method	DIN-rail mountable (EN 60715)	
Housing	Black plastic, flame retardant	
Temperature range	-20...+60 °C	

## Dimension drawing

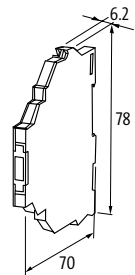
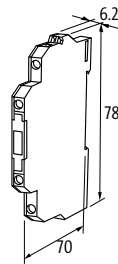
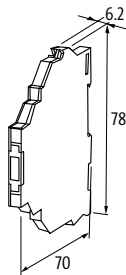
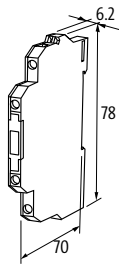

## Notes

## Terminal optocoupler

– with bridge system

Approvals:

### MIRO 6.2

Transistor 10 A  
Screw terminals



### MIRO 6.2

Transistor 10 A  
Spring clamp terminals



### MIRO 6.2

Transistor 0.5 A  
Screw terminals



### MIRO 6.2

Transistor 0.5 A  
Spring clamp terminals



## Circuit diagram

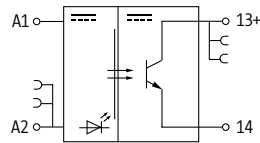

## Order Data

24 V DC/10 mA (pulse control operation)  
24 V DC/6 mA

Art-No.  
52521

Art-No.  
6652521

Art-No.  
52500

Art-No.  
6652500

## Input

Voltage range ON 10...53 V DC  
Voltage range OFF 0...5 V DC  
Control current 10 mA  
LED display LED (yellow)

6 mA

## Output

Switching voltage 5...48 V DC  
Switching current per output 1 mA...10 A, short-circuit and overload protected (pulse switching)  
Saturation voltage (across output) max. 0.12 V DC  
Leakage current (output is open) max. 25  $\mu$ A  
Switching time ON/OFF 2/5 ms (10 A load)  
Switching frequency max. 1/0.1 Hz (resist./ind.)

0.1 mA...0.5 A

max. 1.2 V DC

max. 10  $\mu$ A

35/400  $\mu$ s

max. 1000/100 Hz (resist./ind.)

## General data

Test isolation voltage 2.75 kV  
Mounting method DIN-rail mountable (EN 60715)  
Housing Black plastic, flame retardant  
Temperature range -20...+60 °C

3.75 kV

## Dimension drawing

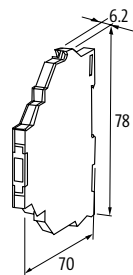
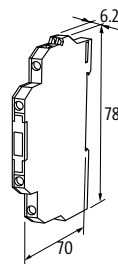
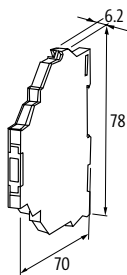
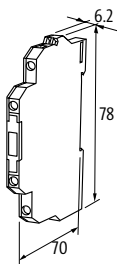

## Notes

# OPTOCOUPLEDERS / SEMICONDUCTORS

## Terminal optocoupler

– with bridge system

Approvals:  

### MIRO 6.2

Transistor 0.5 A  
Screw terminals



### MIRO 6.2

Transistor 0.5 A  
Spring clamp terminals



### MIRO 6.2

Transistor 0.5 A  
Screw terminals



### MIRO 6.2

Transistor 0.5 A  
Spring clamp terminals



## Circuit diagram

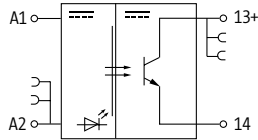

Order Data	Art-No.	Art-No.	Art-No.	Art-No.
110 V AC/DC - 6 mA	52506	6652506		
230 V AC - 6 mA			52507	6652507

Input		
Voltage range ON	70...130 V AC/DC	90...250 V AC
Voltage range OFF	0...30 V AC/DC	0...40 V AC
Control current	6 mA	7 mA
LED display	LED (yellow)	

Output		
Switching voltage	5...48 V DC	
Switching current per output	0.1 mA...0.5 A	
Saturation voltage (across output)	max. 1.2 V DC	
Leakage current (output is open)	max. 0.3 mA	
Switching time ON/OFF	100/700 $\mu$ s	55/15 ms
Switching frequency	max. 500/30 Hz (resist./ind.)	

General data	
Test isolation voltage	3.75 kV
Mounting method	DIN-rail mountable (EN 60715)
Housing	Black plastic, flame retardant
Temperature range	-20...+60 °C

## Dimension drawing

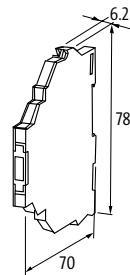
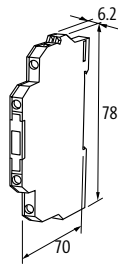
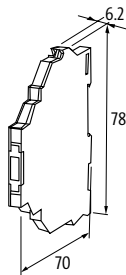
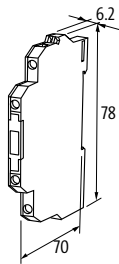

## Notes

## Terminal optocoupler

– with bridge system

Approvals:

### MIRO 6.2

Transistor 2 A  
Screw terminals



### MIRO 6.2

Transistor 2 A  
Spring clamp terminals



### Circuit diagram

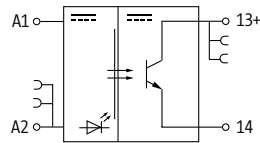

### Order Data

230 V AC - 6 mA

### Art-No.

52508

### Art-No.

6652508

### Input

Voltage range ON 90...250 V AC

Voltage range OFF 0...30 V AC

Control current 15 mA

LED display LED (yellow)

### Output

Switching time ON/OFF 3/10 ms

Switching voltage 5...48 V DC

Switching current per output 1 mA...2 A (without derating)

Saturation voltage (across output) max. 0.3 V DC

Leakage current (output is open) max. 0.3 mA

Switching frequency max. 10/1 Hz (resist./ind.)

### General data

Test isolation voltage 2.5 kV

Mounting method DIN-rail mountable (EN 60715)

Housing Black plastic, flame retardant

Temperature range -20...+60 °C

### Dimension drawing

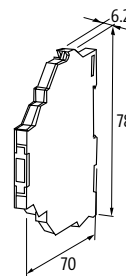
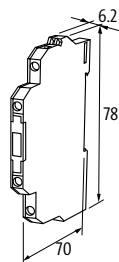

### Notes

# OPTOCOUPLEDERS / SEMICONDUCTORS

## Terminal optocoupler

– with bridge system

Approvals:  

### MIRO 6.2

Transistor 2 A  
Inrush current limiting  
Screw terminals



### MIRO 6.2

Transistor 2 A  
Inrush current limiting  
Spring clamp terminals



### MIRO 6.2

Transistor 0.5 A  
electr. NO/NC contact  
Screw terminals



### MIRO 6.2

Transistor 0.5 A  
electr. NO/NC contact  
Spring clamp terminals



## Circuit diagram

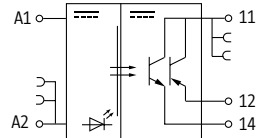
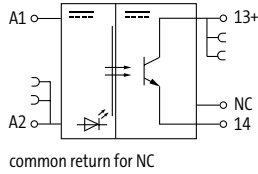

Order Data	Art-No.	Art-No.	Art-No.	Art-No.
24 V DC/6 mA	52512	6652512	52510	6652510
<b>Input</b>				
Voltage range ON	10...53 V DC			
Voltage range OFF	0...5 V DC			
Control current	6 mA			
LED display	LED (yellow)			
<b>Output</b>				
Switching voltage	5...48 V DC			
Switching current per output	1 mA...2 A (overload protected)		0.1 mA...0.5 A	
Saturation voltage (across output)	max. 0.35 V DC		max. 1.2 V DC	
Leakage current (output is open)	max. 0.1 mA			
Switching time ON/OFF	5/10 ms		40/150 µs	
Switching frequency	max. 10 Hz			
<b>General data</b>				
Test isolation voltage	2.5 kV		3.75 kV	
Housing	Black plastic, flame retardant			
Mounting method	DIN-rail mountable (EN 60715)			
Temperature range	-20...+60 °C			
<b>Dimension drawing</b>				

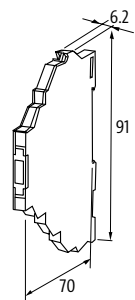
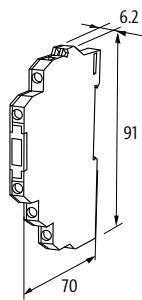
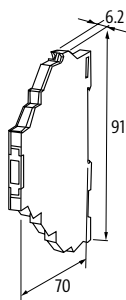
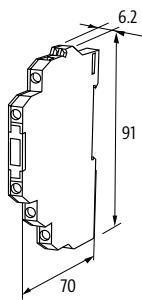

## Notes

## Terminal optocoupler

– with bridge system

### MIRO 6.2

Transistor 0.2 A  
Control current 0.1 mA (5 V DC)  
Screw terminals



### MIRO 6.2

Transistor 0.2 A  
Control current 0.1 mA (5 V DC)  
Spring clamp terminals



### MIRO 6.2

Transistor 2 A  
short-circuit protected  
Screw terminals



### MIRO 6.2

Transistor 2 A  
short-circuit protected  
Spring clamp terminals



Approvals: us

## Circuit diagram

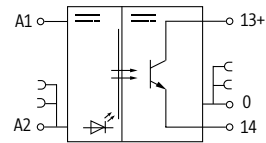
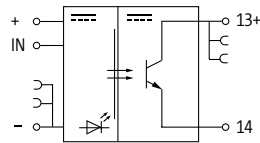

## Order Data

24 V DC/0.1 mA (5 V DC)

cCSAus

### Art-No.

52511

cCSAus

### Art-No.

6652511

### Art-No.

52503

### Art-No.

6652503

24 V DC/6 mA

## Input

Voltage range ON

15...30 V DC

Voltage range OFF

0...2 V DC

Control current

0.1 mA (5 V)

LED display

LED (yellow)

## Output

Switching voltage

5...48 V DC

Switching current per output

0.1 mA...0.2 A

Saturation voltage (across output)

max. 1.2 V DC

Leakage current (output is open)

max. 0.1 mA

Switching frequency

max. 20 kHz

Switching time ON/OFF

10/18 µs

10...48 V DC

0...5 V DC

6 mA

10...35 V DC

1 mA...2 A (short-circuit protected)

max. 1 kHz

90/120 µs

## General data

Test isolation voltage

3.75 kV

Mounting method

DIN-rail mountable (EN 60715)

Housing

Black plastic, flame retardant

Temperature range

-20...+60 °C

## Dimension drawing

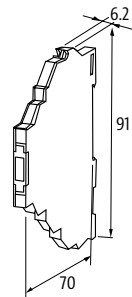
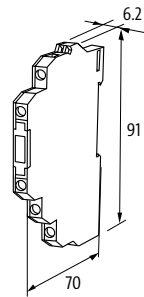
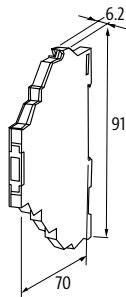
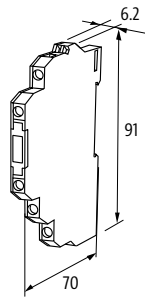

## Notes

# OPTOCOUPLEDERS / SEMICONDUCTORS

## Terminal optocoupler

– with bridge system

### MIRO 6.2

Transistor 1 A  
Multi voltage output  
Screw terminals



### MIRO 6.2

Transistor 1 A  
Multi voltage output  
Spring clamp terminals



### MIRO 6.2

Transistor 0.2 A  
Spring clamp terminals



### MIRO 6.2

Transistor 0.1 A  
Spring clamp terminals

## Circuit diagram

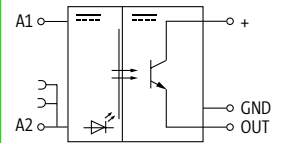
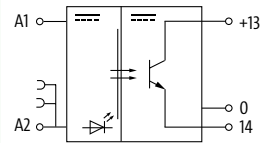
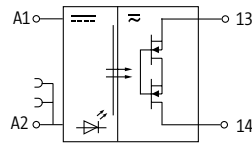

Order Data	Art-No.	Art-No.	Art-No.	Art-No.
24 V DC/10 mA	52572	6652572	UR, cCSAus	526071
<b>Input</b>				
Voltage range ON	10...53 V DC		10...35 V DC	10...30 V DC
Voltage range OFF	0...5 V DC			0...7 V DC
Control current	10 mA		6 mA	5.5 mA
LED display	LED (yellow)		LED (green)	LED (yellow)
<b>Output</b>				
Switching time ON/OFF	3/6 ms		5/7 $\mu$ s	0.4/0.1 $\mu$ s
Switching voltage	5...250 V AC/5...350 V DC		10...30 V DC	5...48 V DC
Switching current per output	1 mA...1 A		1 mA...0.2 A	0...0.1 A
Saturation voltage (across output)	max. 0.7 V AC/DC		max. 0.3 V AC/DC	max. 1.2 V AC/DC
Leakage current (output is open)	max. 25 $\mu$ A			max. 250 $\mu$ A
Switching frequency	max. 10 Hz		max. 20 kHz/200 Hz (resist./ind.)	500 kHz (ohmic)
<b>General data</b>				
Test isolation voltage	2.75 kV		2.5 kV	2.75 kV
Mounting method	DIN-rail mountable (EN 60715)			
Housing	Black plastic, flame retardant			
Temperature range	-20...+60 °C			

## Dimension drawing

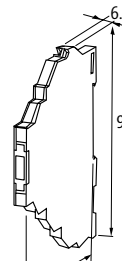
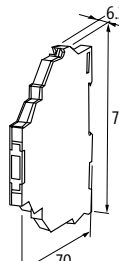
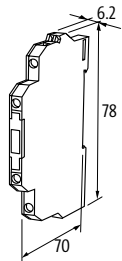

## Notes

## Terminal optocoupler

– Isolation function in output circuit

### MIRO 6.2

Transistor 2 A  
Screw terminals



### MIRO 6.2

Transistor 2 A  
Spring clamp terminals



Approvals:

### Circuit diagram

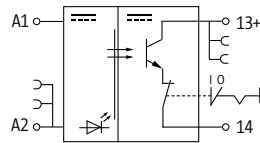

### Order Data

24 V DC/7 mA

### Art-No.

52513

### Art-No.

6652513

### Input

Voltage range ON	10...48 V DC
Voltage range OFF	0...5 V DC
Control current	7 mA
LED display	LED (yellow)

### Output

Switching time ON/OFF	1/5 ms
Switching voltage	5...48 V DC
Switching current per output	1 mA...2 A
Saturation voltage (across output)	max. 0.3 V DC
Leakage current (output is open)	max. 0.3 mA
Switching frequency	max. 10/1 Hz (resist./ind.)

### General data

Housing	Black plastic, flame retardant
Test isolation voltage	2.5 kV
Mounting method	DIN-rail mountable (EN 60715)
Temperature range	-20...+60 °C

### Dimension drawing

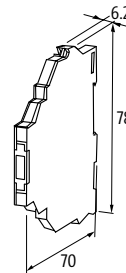
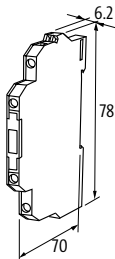

### Notes



# OPTOCOUPLEDERS / SEMICONDUCTORS

## Optocouplers

- Inrush current limiting
- Screw terminals

### AMMS

Transistor 1.2 A



### EMMS

Transistor 1.2 A

#### Circuit diagram

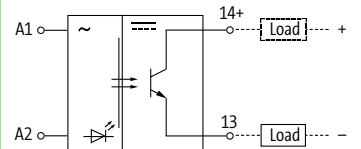
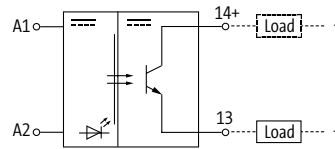
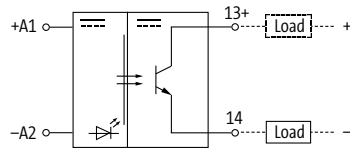

Order Data	Art-No.	Art-No.	Art-No.
3.5...5.5 V DC/6 mA	50041		
24 V DC/6 mA		50040	
110/230 V AC/2.7 mA			50105
<b>Input</b>			
Voltage range ON	3.5...5.5 V DC	10...53 V DC	100...253 V AC
Voltage range OFF	0...0.8 V DC	0...3 V DC	0...40 V AC
Input current	6 mA		2.7 mA
LED display	LED (red)		
<b>Output</b>			
Leakage current (output is open)	max. 0.3 mA		
Switching current per output	1 mA...1.2 A		
Switching voltage	4.5...53 V DC		
Saturation voltage (across output)	max. 1.2 V DC		
Switching time ON/OFF	100/700 μs		20/50 ms
Switching frequency	max. 500 Hz (resist.) at max. 0.2 A/max. 30 Hz (ind.)		max. 5 Hz
<b>General data</b>			
Test isolation voltage	3.75 kV		
Mounting method	DIN-rail mountable TH35 or G32 (EN 60715)		
Housing	Black plastic, flame retardant		
Temperature range	-20...+60 °C		

#### Dimension drawing

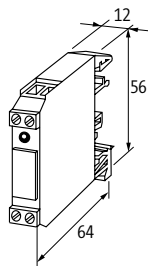

#### Notes

## Optocouplers

- Inrush current limiting
- Screw terminals

### AMMS

Transistor 0.5 A



### AMMS

Transistor 2 A

#### Circuit diagram

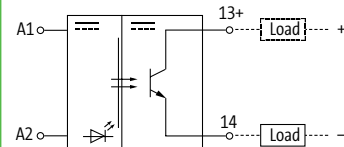
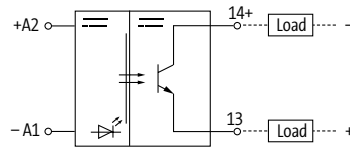

#### Order Data

4...30 V DC/10 mA  
24 V DC/6 mA

Art-No.  
50010

Art-No.

50070

#### Input

Voltage range ON 4...30 V DC  
Voltage range OFF 0...2 V DC  
Input current max. 10 mA  
LED display LED (red)

10...53 V DC  
0...3 V DC  
6 mA

#### Output

Switching voltage 4.5...44 V DC  
Switching current per output 1 mA...0.5 A  
Saturation voltage (across output) max. 1.2 V DC  
Leakage current (output is open) max. 0.3 mA  
Switching time ON/OFF 65 µs/20 ms  
Switching frequency max. 7 kHz (resist.) at max. 0.1 A/max. 10 Hz (ind.)

4.5...40 V DC  
10 mA...2 A  
max. 0.1 V DC  
max. 0.1 mA  
2/8 ms  
max. 20/5 Hz (resist./ind.)

#### General data

Test isolation voltage 3.75 kV  
Mounting method DIN-rail mountable TH35 or G32 (EN 60715)  
Housing Black plastic, flame retardant  
Temperature range -20...+60 °C

2.5 kV

#### Dimension drawing

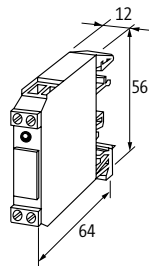

#### Notes

# OPTOCOUPLEDERS / SEMICONDUCTORS

## Optocouplers

– Double terminals on the output side

– Screw terminals

### AMMDS

Transistor 0.1 A  
with minus plug link



### AMMDS

Transistor 2 A  
with minus plug link

### AMMDS

Transistor 0.1 A

## Circuit diagram

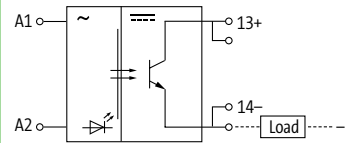
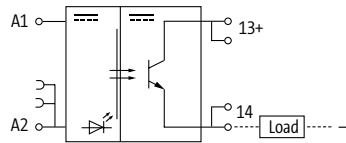

Order Data	Art-No.	Art-No.	Art-No.
24 V DC/6 mA	50081	50080	
230 V AC - 10 mA			50110

Input			
LED display	LED (red)		
Input current	6 mA		7.5 mA
Plug link (supplied)	Art.-No. 90960		–
Voltage range ON	10...53 V DC		195...253 V AC
Voltage range OFF	0...3 V DC		0...110 V AC
Output			
Switching voltage	4...40 V DC	4...35 V DC	4...40 V DC
Switching current per output	1 mA...0.1 A	10 mA...2 A (short-circuit protected)	1 mA...0.1 A
Saturation voltage (across output)	max. 1.2 V DC	max. 0.5 V DC	max. 1.2 V DC
Leakage current (output is open)	max. 0.3 mA		
Switching time ON/OFF	1.5/2 ms	5/15 ms	50/120 ms
Switching frequency	max. 300/40 Hz (resist./ind.)	max. 10/1 Hz (resist./ind.)	
General data			
Mounting method	DIN-rail mountable TH35 or G32 (EN 60715)		
Housing	Black plastic, flame retardant		
Temperature range	-20...+60 °C		
Test isolation voltage	3.75 kV	2.5 kV	3.75 kV

## Dimension drawing

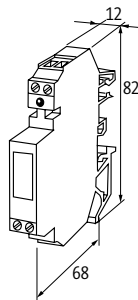

## Notes

# OPTOCOUPLEDERS / SEMICONDUCTORS

## Optocouplers

– with minus plug link

– Screw terminals

### AMMDS

Transistor 0.2 A  
Double terminals on the output side  
for rapid switching



### AMMDS

Transistor 1 A

#### Circuit diagram

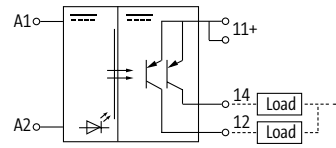
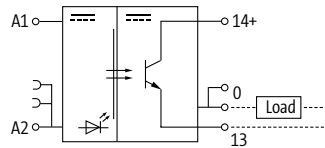

#### Order Data

24 V DC/15 mA

#### Art-No.

50082

#### Art-No.

24 V AC/DC - 10 mA

50085

#### Input

Voltage range ON

10...35 V DC

10...53 V DC

Voltage range OFF

0...5 V DC

0...6 V DC

Input current

10 mA

LED display

LED (red)

Plug link (supplied)

Art.-No. 90960

–

#### Output

Switching voltage

5...35 V DC

4.5...53 V DC

Switching current per output

1 mA...0.2 A

1 mA...1 A

Saturation voltage (across output)

max. 0.5 V DC

Leakage current (output is open)

max. 0.3 mA

Switching time ON/OFF

20/14  $\mu$ s

25/75  $\mu$ s

Switching frequency

max. 20 kHz/200 Hz (resist./ind.)

max. 1 kHz/10 Hz (resist./ind.)

#### General data

Test isolation voltage

2.5 kV

Mounting method

DIN-rail mountable TH35 or G32 (EN 60715)

Housing

Black plastic, flame retardant

Temperature range

-20...+60 °C

#### Dimension drawing

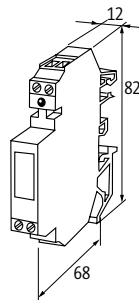

#### Notes

# OPTOCOUPLEDERS / SEMICONDUCTORS

## Power opto-coupler modules

### – Screw terminals

#### AMS

Transistor 4 A



#### AMS

Transistor 2 A (3-way)  
3 NO contacts



#### AMS

Transistor 2 A (4-way)  
4 NO contacts



### Circuit diagram

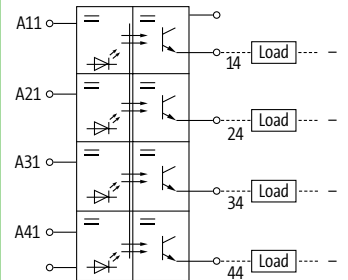
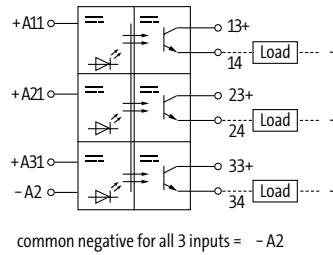
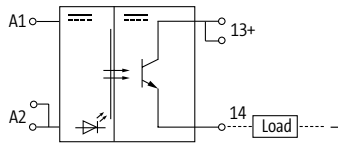

Order Data	Art-No.	Art-No.	Art-No.
24 V DC/10 mA	50044	50043	
24 V DC/3 mA			cCSAus 50015
Input			
Voltage range ON	10...53 V DC		20...30 V DC
Voltage range OFF	0...3 V DC		0...6 V DC
Input current	14.5 mA	10 mA	27 mA
LED display	LED (red)		LED (yellow)
Output			
Switching voltage	4.5...53 V DC	4.5...35 V DC	5...30 V DC
Switching current per output	10 mA...4 A	10 mA...2 A (short-circuit protected)	1 mA...2 A
Saturation voltage (across output)	max. 1.5 V DC	max. 0.5 V DC	max. 0.05 V DC
Switching time ON/OFF	4/7 μs	2/15 ms	1/5 ms
Leakage current (output is open)	–	max. 0.3 mA	max. 0.01 mA
Switching frequency	max. 2 kHz/4 Hz (resist./ind.)	max. 10/1 Hz (resist./ind.)	
General data			
Test isolation voltage	3.75 kV	2.5 kV	
Mounting method	DIN-rail mountable TH35 or G32 (EN 60715)		
Housing	Black plastic, flame retardant		
Temperature range	-20...+60 °C		-25...+50 °C

### Dimension drawing

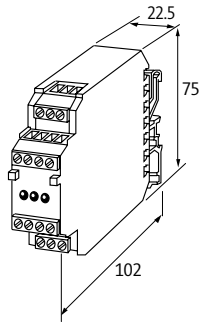

### Notes

# OPTOCOUPLEDERS / SEMICONDUCTORS

## Optocouplers

- DC Motor control
- Over current / temperature monitoring

### MIRO 12.4

Transistor 3 A  
Screw terminals



### MIRO 12.4

Transistor 3 A  
Spring clamp terminals



### Circuit diagram

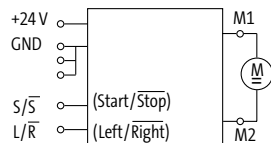

### Order Data

24 V DC/10 mA

### Art-No.

50140

### Art-No.

6650140

### Input

Voltage range ON	15...30 V DC
Voltage range OFF	0...5 V DC
Input current	10 mA
LED display	LED (yellow): right running; LED (green): left running

### Output

Switching voltage	19.2...30 V DC
Switching current per output	max. 3 A
Highest current	approx. 6 A for 100 ms
Saturation voltage (across output)	max. 1.4 V DC
Leakage current (output is open)	max. 10 mA
Switching time ON/OFF	1.2/10 ms
Switching frequency	max. 1 Hz (motor dependant)
Changing time	max. 50 ms
LED display	LED (red): error (over current/over heated)

### General data

Test isolation voltage	no galvanic separation
Mounting method	DIN-rail mountable TH35 or G32 (EN 60715)
Housing	Black plastic, flame retardant
Temperature range	0...+50 °C

### Dimension drawing

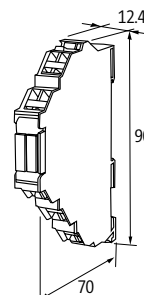
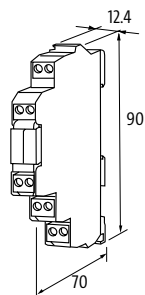

### Notes

# OPTOCOUPLEDERS / SEMICONDUCTORS

Terminal triac

– Zero potential switch

Approvals:  

## MIRO 6.2

Triac 0.5 A  
Screw terminals



## MIRO 6.2

Triac 0.5 A  
Spring clamp terminals



## MIRO 6.2

Triac 0.5 A  
Screw terminals



## MIRO 6.2

Triac 0.5 A  
Spring clamp terminals



### Circuit diagram

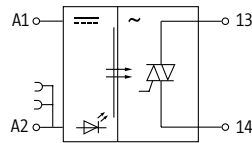

Order Data	Art-No.	Art-No.	Art-No.	Art-No.
5 V DC/6 mA	52551	6652551		
24 V DC/6 mA			52550	6652550

Input		
Voltage range ON	4...5.5 V DC	10...53 V DC
Voltage range OFF	0...2 V DC	0...5 V DC
Control current	6 mA	
LED display	LED (yellow)	
Output		
Switching voltage	24...250 V AC	
Switching current per output	2 mA...0.5 A	1.5 mA...0.5 A
Saturation voltage (across output)	max. 1.5 V AC	
Leakage current (output is open)	max. 0.3 mA	
Switching time ON/OFF	10/10 ms	
Switching frequency	max. 20 Hz, depending on suppression	
General data		
Test isolation voltage	2.5 kV	
Mounting method	DIN-rail mountable (EN 60715)	
Housing	Black plastic, flame retardant	
Temperature range	-20...+60 °C	

### Dimension drawing

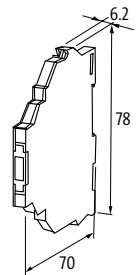
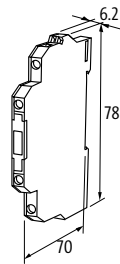
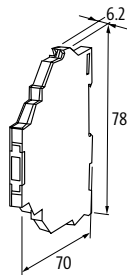
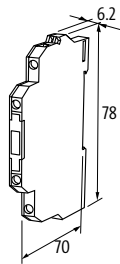

### Notes

## Terminal triac

### – Zero potential switch

#### MIRO 6.2

Triac 1 A  
Screw terminals



#### MIRO 6.2

Triac 1 A  
Spring clamp terminals



## Circuit diagram

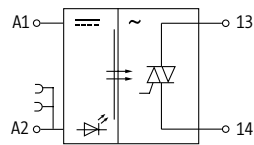

## Order Data

24 V DC/9 mA

## Art-No.

52571

## Art-No.

6652571

## Input

Voltage range ON

12...53 V DC

Voltage range OFF

0...3 V DC

Control current

12 mA (24 V DC)

LED display

LED (yellow)

## Output

Switching voltage

12...250 V AC

Switching current per output

10 mA...1 A

Saturation voltage (across output)

max. 1.5 V AC

Leakage current (output is open)

max. 1 mA

Switching time ON/OFF

10/10 ms

Switching frequency

max. 2 Hz, depending on suppression

## General data

Test isolation voltage

2.5 kV

Mounting method

DIN-rail mountable (EN 60715)

Housing

Black plastic, flame retardant

Temperature range

0...+60 °C

## Dimension drawing

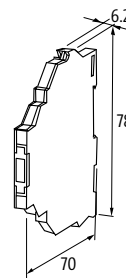
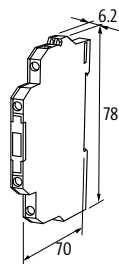

## Notes



# OPTOCOUPLEDERS / SEMICONDUCTORS

Terminal triac

– Zero potential switch

Approvals:  

## MIRO 6.2

Triac 0.5 A  
Screw terminals



## MIRO 6.2

Triac 0.5 A  
Spring clamp terminals



## MIRO 6.2

Triac 0.5 A  
Screw terminals



## MIRO 6.2

Triac 0.5 A  
Spring clamp terminals



### Circuit diagram

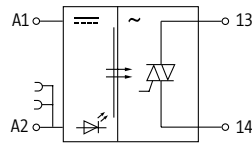

Order Data	Art-No.	Art-No.	Art-No.	Art-No.
110 V AC/DC (95...121 V AC/DC) - 3.5 mA	52556	6652556		
230 V AC - 7 mA			52557	6652557

Input		
Voltage range ON	70...130 V AC/DC	140...250 V AC
Voltage range OFF	0...35 V AC/DC	0...80 V AC
Control current	3.5 mA	7 mA
LED display	LED (yellow)	

Output		
Switching voltage	12...250 V AC	
Switching current per output	2 mA...0.5 A	
Saturation voltage (across output)	max. 1.5 V AC	
Leakage current (output is open)	max. 0.3 A	max. 0.3 mA
Switching time ON/OFF	10/10 ms	
Switching frequency	max. 20 Hz, depending on suppression	

General data	
Test isolation voltage	2.5 kV
Mounting method	DIN-rail mountable (EN 60715)
Housing	Black plastic, flame retardant
Temperature range	-20...+60 °C

### Dimension drawing

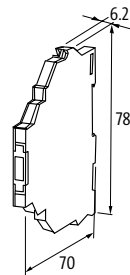
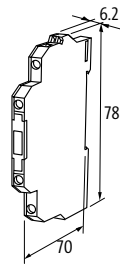
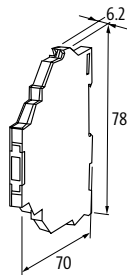
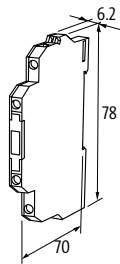

### Notes

**Terminal triac**

**– Zero potential switch**

**MIRO 6.2**

Triac 0.5 A  
Screw terminals



**MIRO 6.2**

Triac 0.5 A  
Spring clamp terminals



**Circuit diagram**

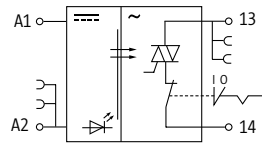

**Order Data**

24 V DC/7 mA

**Art-No.**

52561

**Art-No.**

6652561

**Input**

Voltage range ON 10...53 V DC

Voltage range OFF 0...5 V DC

Control current 7 mA

LED display LED (yellow)

**Output**

Switching voltage 24...250 V AC

Switching current per output 2 mA...0.5 A

Saturation voltage (across output) max. 1.5 V AC

Leakage current (output is open) max. 0.3 mA

Switching time ON/OFF 10/10 ms

Switching frequency max. 20/1 Hz (resist./ind.)

**General data**

Test isolation voltage 2.5 kV

Mounting method DIN-rail mountable (EN 60715)

Housing Black plastic, flame retardant

Temperature range -20...+60 °C

**Dimension drawing**

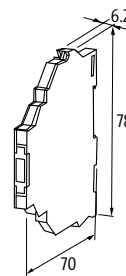
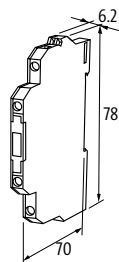

**Notes**

# OPTOCOUPLEDERS / SEMICONDUCTORS

## Triac modules

- Zero potential switch
- Screw terminals

## AMS

Triac 4 A



## Circuit diagram

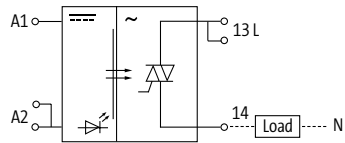

<b>Order Data</b>		<b>Art-No.</b>
24 V DC/10 mA		50034

<b>Input</b>	
Voltage range ON	10...53 V DC
Voltage range OFF	0...3 V DC
Input current	10 mA
LED display	LED (red)

<b>Output</b>	
Switching voltage	24...250 V AC
Switching current per output	10 mA...4 A
Saturation voltage (across output)	max. 1.4 V AC
Leakage current (output is open)	max. 10 mA
Switching time ON/OFF	10/10 ms
Switching frequency	max. 30/5 Hz (resist./ind.)

<b>General data</b>	
Test isolation voltage	6 kV
Mounting method	DIN-rail mountable TH35 or G32 (EN 60715)
Housing	Black plastic, flame retardant
Temperature range	-20...+60 °C

## Dimension drawing

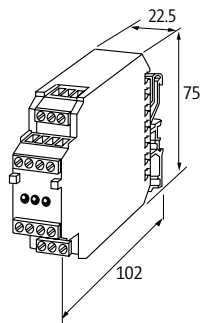

## Notes

# OPTOCOUPLEDERS / SEMICONDUCTORS

## Triac modules

– Zero potential switch

– Screw terminals

### AMMS

Triac 1 A



### AMMDS

Triac 2 A  
with minus plug link



### Circuit diagram

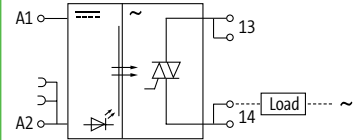
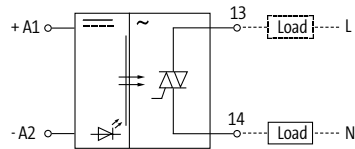

### Order Data

24 V DC/6.6 mA

### Art-No.

50030

### Art-No.

24 V DC/6 mA

50092

### Input

Voltage range ON

10...53 V DC

10...35 V DC

Voltage range OFF

0...3 V DC

Input current

6.6 mA

6 mA

LED display

LED (red)

Plug link (supplied)

–

Art-No. 90960

### Output

Switching voltage

24...253 V AC

24...280 V AC

Switching current per output

50 mA...1 A

50 mA...2 A

Saturation voltage (across output)

max. 1.3 V AC

max. 1 V AC

Leakage current (output is open)

max. 5 mA

max. 2 mA

Switching time ON/OFF

10/10 ms

Switching frequency

max. 20 Hz

max. 20/5 Hz (resist./ind.)

### General data

Test isolation voltage

2.5 kV

Mounting method

DIN-rail mountable TH35 or G32 (EN 60715)

Housing

Black plastic, flame retardant

Temperature range





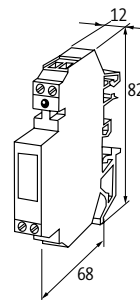
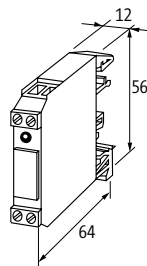



-20...+60 °C

### Dimension drawing



### Notes

## OPTOCOUPERS / SEMICONDUCTORS

Labeling accessories			Art-No.
	<b>ACS label plate (KM 5)</b> for self marking (9 × 20 mm)		7000-99001-000000
	<b>Label plate (KM 4)</b> 5 × 10 mm		90931
	<b>ACS label plate (KM 6/18)</b> for self marking with ADEMARK markers		7000-99003-000000
	<b>Label plate (KWI 5/15)</b> (88 pieces per plate)		90901
Wiring accessories			Art-No.
	<b>Potential plug link</b> max. 50 V/2 A	MIRO	90961
	<b>Potential plug link</b> max. 48 V/2 A	RMM..., RMDM...	90960
	<b>Potential rail blue</b> 40-pole, spacing 12 mm	RMM..., RMDM...	90970
	10-pole, spacing 6.2 mm	MIRO 6.2 (screw terminals)	90975
	<b>Potential rail red</b> 40-pole, spacing 12 mm	RMM..., RMDM...	90971
	10-pole, spacing 6.2 mm	MIRO 6.2 (screw terminals)	90976
	<b>End caps for potential rail</b> blue	MIRO 6.2 RMM..., RMDM...	90980
	red	MIRO 6.2 RMM..., RMDM...	90982

Wiring accessories			Art-No.
	<p><b>Wire chain 16-pole</b>                      Connection cable left and right approx. 50 cm; bk; 1 mm<sup>2</sup></p>	<p>MIRO (spring clamp terminals)</p>	<p>90977</p>



# SWITCHES

## PERFECT CROSS-LINKING FOR YOUR APPLICATION

- Reduces the installation effort
- Switches for the control cabinet IP20, IP50, and the field IP67
- Compact and robust design

### FROM SOLID BASIC FUNCTIONS TO AN ENORMOUS FUNCTIONAL VARIETY

Murrelektronik offers a broad portfolio of switches. Unmanaged switches are used to reliably cover basic functions at an advantageous price-performance ratio. Lite-managed switches offer a large scope of functions and variants such as the PROFINET managed switches are tailored perfectly to the possibilities of PROFINET environments.

- Optimization of wiring flexibility and reduction of the complexity of installation solutions
- Easy insights into the communication and uncomplicated connection to network analysis tools or integrated web servers
- Relocation of the coupling level to the field creating space in the control cabinet by using compact and robust IP67 variants

### Unmanaged Switches



#### Unmanaged Switches

- IP20
- IP50
- IP67

*Page 1.11.1*

### Managed Switches



#### Lite-Managed Switches

- IP20
- IP67

*Page 1.11.4*



#### PROFINET-Managed Switches

- IP20
- IP67



*Page 1.11.6*

# SWITCHES

## Unmanaged Switch

### TREE 4TX Metal

IP50



### TREE 8TX Metal

IP50



### TREE 6TX Eco

IP20



### TREE 8TX Metal

IP50



Approvals:  UL Listed

Order Data	Art-No.	Art-No.	Art-No.	Art-No.
4 ports	<b>58151</b>			
8 ports		<b>58152</b>		<b>58171</b>
6 ports			<b>58170</b>	
<b>Connections</b>				
Fieldbus	4 × RJ45	8 × RJ45	6 × RJ45	8 × RJ45
Supply	Spring clamp plug-in terminal: 0.2...2.5 mm <sup>2</sup>		Screw plug-in terminal: 0.2...1.5 mm <sup>2</sup>	
<b>Technical Data</b>				
Operating voltage	2 × 9...48 V DC, redundancy		2 × 9...30 V DC, redundancy	2 × 9...48 V DC, redundancy
Transfer rate	10/100 Mbit/s full duplex			
Operating modes	Autocrossing Autonegotiation			
<b>Switch Management</b>				
Switch Form	Unmanaged Switch			
Webserver	no			
VLAN (QoS) IEEE 802.p	yes			
Port Mirroring	no			
Protocols	no			
Remote maintenance	no			
Alarm contact	no			
<b>Diagnostic</b>				
Communication status	via LED			
Monitoring - no voltage	yes			
<b>General data</b>				
Protection	IP50		IP20	IP50
Housing	Metal black		Black plastic	Metal black
Mounting method	DIN-rail mountable TH35 (EN 60715)			
Temperature range	-10...+70 °C (storage temperature -40...+85 °C)		0...+60 °C (storage temperature -10...+70 °C)	-10...+70 °C (storage temperature -40...+85 °C)

### Dimension drawing

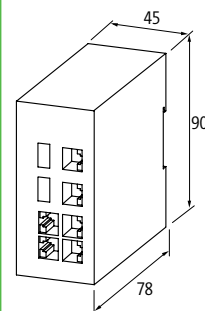
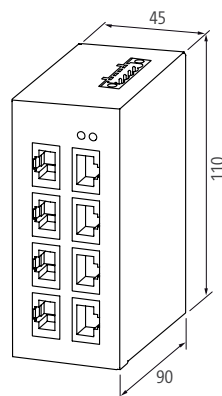
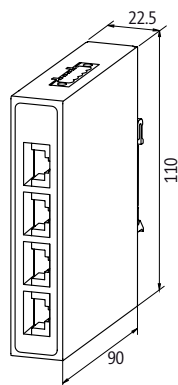

### Notes



# SWITCHES

## Unmanaged Switch

### TREE 6TX Metal

IP50



### TREE 8TX Metal

8 ports Gigabit  
IP50



Approvals:  Listed

Order Data	Art-No.	Art-No.
6 ports	58172	
8 ports Gigabit		58173
<b>Connections</b>		
Fieldbus	6 × RJ45	8 × RJ45
Supply	Screw plug-in terminal: 0.2...1.5 mm <sup>2</sup>	
<b>Technical Data</b>		
Operating voltage	2 × 9...30 V DC, redundancy	2 × 9...48 V DC, redundancy
Transfer rate	10/100 Mbit/s full duplex	10/100/1 000 Mbit/s full duplex
Operating modes	Autocrossing Autonegotiation	
<b>Switch Management</b>		
Switch Form	Unmanaged Switch	
Websserver	no	
VLAN (QoS) IEEE 802.p	yes	
Port Mirroring	no	
Protocols	no	
Remote maintenance	no	
Alarm contact	no	
<b>Diagnostic</b>		
Communication status	via LED	
Monitoring - no voltage	yes	
<b>General data</b>		
Protection	IP50	
Housing	Metal black	
Mounting method	DIN-rail mountable TH35 (EN 60715)	
Temperature range	-10...+70 °C (storage temperature -40...+85 °C)	
<b>Dimension drawing</b>		

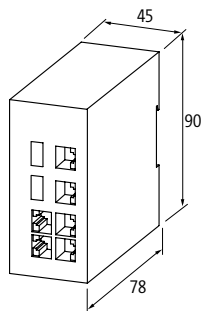

## Notes

# SWITCHES

## Unmanaged Switch

### TREE 4TX IP67 M12

4 × M12 (female), D-coded  
IP67



### TREE 8TX IP67 M12

8 × M12 (female), D-coded  
IP67



Approvals:  UL  
Listed

Order Data	Art-No.	Art-No.
4 ports	<b>58160</b>	
8 ports		<b>58161</b>
Connections		
Fieldbus	4 × M12 (female), D-coded	8 × M12 (female), D-coded
Supply	1 × M12 (male), A-coded	
Technical Data		
Operating voltage	2 × 18...30 V DC, redundancy	
Transfer rate	10/100 Mbit/s full duplex	
Operating modes	Autocrossing Autonegotiation	
Switch Management		
Switch Form	Unmanaged Switch	
Webserver	no	
VLAN (QoS) IEEE 802.p	yes	
Port Mirroring	no	
Protocols	no	
Remote maintenance	no	
Alarm contact	no	
Diagnostic		
Communication status	via LED	
Monitoring - no voltage	yes	
General data		
Protection	IP67	
Housing	Zinc die casting, matte nickel plated	
Mounting method	4 hole screw mounting	
Temperature range	-25...+60 °C (storage temperature -40...+80 °C)	
Dimension drawing		

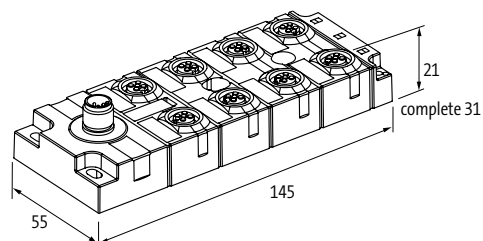
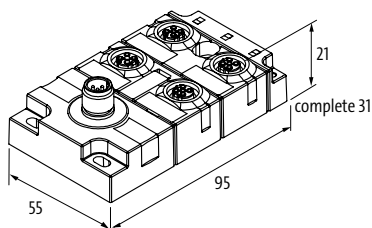

## Notes

# SWITCHES

## Lite - Managed Switch

### TREE M-4TX

IP20



### TREE M-6TX

IP20



Order Data	Art-No.	Art-No.
4 ports	58181	
6 ports		58182
Connections		
Fieldbus	4 × RJ45	6 × RJ45
Supply	Spring clamp plug-in terminal: 0.2...2.5 mm <sup>2</sup>	
Technical Data		
Operating voltage	9.5...31.5 V	
Transfer rate	10/100 Mbit/s full duplex	
Operating modes	Autocrossing Autonegotiation	
Switch Management		
Switch Form	Lite - Managed Switch	
Webserver	HTTP, HTTPS	
VLAN (QoS) IEEE 802.p	yes	
Port Mirroring	DHCP, SNMP (v1, v2c, v3), RSTP, STP	
Protocols	DHCP, SNMP (v1, v2c, v3), RSTP, STP, LLDP, NTP, RMON, SSH (CLI)	
Remote maintenance	Open VPN	
Alarm contact	no	yes
Diagnostic		
Communication status	via LED, LLDP	
Monitoring - no voltage	yes	
General data		
Protection	IP20	
Housing	Black plastic	
Mounting method	DIN-rail mountable (EN 50022)	
Temperature range	0...+60 °C (storage temperature -40...+85 °C)	
Dimension drawing		

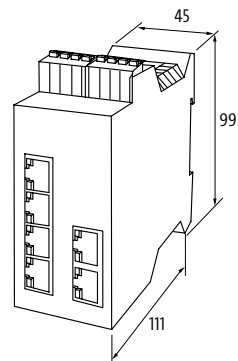
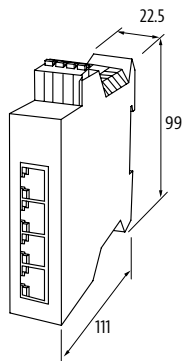

## Notes

## Lite - Managed Switch

### TREE M-STX-PN IP67

IP67



<b>Order Data</b>		<b>Art-No.</b>
5 ports		<b>58183</b>
<b>Connections</b>		
Fieldbus	5 × M12 (female), D-coded	
Supply	1 × M12 (male), A-coded	
<b>Technical Data</b>		
Operating voltage	9.5...31.5 V	
Transfer rate	10/100 Mbit/s full duplex	
Operating modes	Autocrossing Autonegotiation	
<b>Switch Management</b>		
Switch Form	Lite - Managed Switch	
Websserver	HTTP, HTTPS	
VLAN (QoS) IEEE 802.p	yes	
Port Mirroring	yes	
Protocols	DHCP, SNMP (v1, v2c, v3), RSTP, STP, LLDP, NTP, RMON, SSH (CLI)	
Remote maintenance	Open VPN	
Alarm contact	no	
<b>Diagnostic</b>		
Communication status	via LED, LLDP	
Monitoring - no voltage	yes	
<b>General data</b>		
Protection	IP67	
Housing	Black plastic	
Mounting method	3 hole screw mounting	
Temperature range	0...+60 °C (storage temperature -40...+85 °C)	
<b>Dimension drawing</b>		

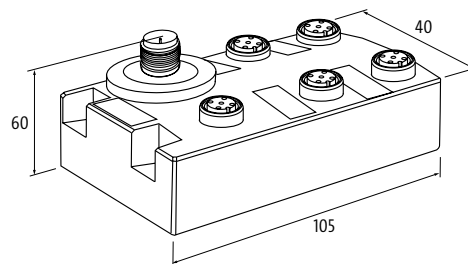

<b>Notes</b>	
--------------	--

# SWITCHES

## PROFINET - Managed Switch



### TREE M-4TX

PROFINET - Managed Switch  
IP20



### TREE M-6TX

PROFINET - Managed Switch  
IP20



Order Data	Art-No.	Art-No.
4 ports	58185	
6 ports		58186
Connections		
Fieldbus	4 × RJ45	6 × RJ45
Supply	Spring clamp plug-in terminal: 0.2...2.5 mm <sup>2</sup>	
Technical Data		
Operating voltage	9.5...31.5 V	
Transfer rate	10/100 Mbit/s full duplex	
Operating modes	Autocrossing Autonegotiation	
Switch Management		
Switch Form	PROFINET - Managed Switch	
Webserver	HTTP, HTTPS	
VLAN (QoS) IEEE 802.p	yes	
Port Mirroring	yes	
Protocols	DHCP, SNMP (v1, v2c, v3), RSTP, STP, LLDP, NTP, RMON, SSH (CLI)	
Remote maintenance	Open VPN	
Alarm contact	no	yes
PROFINET		
Addressing	DCP	
FSU (Fast-Start-Up)	no	
Shared Device/Input	no	
Profinet Netload Class	I	
Specification	V2.3, Conformance Class B	
MRP	yes	
Diagnostic		
Communication status	via LED, LLDP	
Monitoring - no voltage	yes	
General data		
Protection	IP20	
Housing	Black plastic	
Mounting method	DIN-rail mountable (EN 50022)	
Temperature range	0...+60 °C (storage temperature -40...+85 °C)	
Dimension drawing		
Notes		

## PROFINET - Managed Switch



### TREE M-STX-PN IP67

PROFINET - Managed Switch  
IP67



<b>Order Data</b>		<b>Art-No.</b>
5 ports		<b>58184</b>
<b>Connections</b>		
Fieldbus	5 × M12 (female), D-coded	
Supply	1 × M12 (male), A-coded	
<b>Technical Data</b>		
Operating voltage	9.5...31.5 V	
Transfer rate	10/100 Mbit/s full duplex	
Operating modes	Autocrossing Autonegotiation	
<b>Switch Management</b>		
Switch Form	PROFINET - Managed Switch	
Webserver	HTTP, HTTPS	
VLAN (QoS) IEEE 802.p	yes	
Port Mirroring	yes	
Protocols	DHCP, SNMP (v1, v2c, v3), RSTP, STP, LLDP, NTP, RMON, SSH (CLI)	
Remote maintenance	Open VPN	
Alarm contact	no	
<b>PROFINET</b>		
Addressing	DCP	
FSU (Fast-Start-Up)	no	
Shared Device/Input	no	
Profinet Netload Class	I	
Specification	V2.3, Conformance Class B	
MRP	yes	
<b>Diagnostic</b>		
Communication status	via LED, LLDP	
Monitoring - no voltage	yes	
<b>General data</b>		
Protection	IP67	
Housing	Black plastic	
Mounting method	3 hole screw mounting	
Temperature range	0...+60 °C (storage temperature -40...+85 °C)	

### Dimension drawing

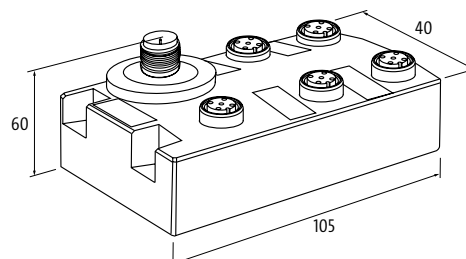

### Notes



# ACTIVE INTERFACE TECHNOLOGY ANALOG AND DIGITAL

- Solid state or relay outputs are short circuit protected
- LED display
- DIN-rail mounting

## CONVERT MEASURED VALUES INTO SIGNALS

While measuring, positioning or checking systems, the status of the machine or installation should be monitored. The measured values have to be converted into digital or standard signals (0...20 mA, 4...20 mA or 0...10V) so that PLCs and computers can process them.

**Murrelektronik offers a wide range of intelligent interface modules that enable signal conversion or signal acquisition with galvanic separation.**

## Active Interface Technology



### Converters

AD/DA converters, Analog converters,  
Frequency converters, U/I converters

*An overview of this product range  
can be found in our online shop*



### Timer

MIRO 6.2 Timer

*An overview of this product range  
can be found in our online shop*



### Comparator modules

MAK

*An overview of this product range  
can be found in our online shop*



### Temperature converter

MTW

*An overview of this product range  
can be found in our online shop*



### Further

Brake rectifiers, Demagnetizer

*An overview of this product range  
can be found in our online shop*



# PASSIVE INTERFACE TECHNOLOGY INTERFACE MODULES

- Screw or spring clamp terminals
- LED displays
- DIN-rail mounting

## FOR ANY APPLICATION

Murrelektronik's interface modules make the connections between the controls and the field.

They take over 3 major functions in the system:

- Signal transfer from the machine to the control
- Signal transfer inside the machine or control system
- Easy wiring in control systems

Murrelektronik has been an innovative partner in coming up with interface solutions for years. Their interface modules are fitted with different kinds of robust plugs like SUB-D connectors or ribbon cable connectors for strong signal or power transfers.

They are extremely compact. Individual terminal labels and status displays are integrated into the standard modules.

## Interface Modules



**With ribbon cable connection**  
UFL

*An overview of this product range can be found in our online shop*



**With SUB-D connector**  
UG SUB, SV

*An overview of this product range can be found in our online shop*



**With pluggable terminals**  
LUGS, PKB

*An overview of this product range can be found in our online shop*



# EUROCARD HOLDERS / CONTROL MODULES

- Flexible applications
- Compact modules
- Connections with up to 96-poles

## THE IDEAL CONTROL TECHNOLOGY FOR THE CABINET

Various electronic circuits are fitted onto 100×160 mm Eurocards and then placed in 19" system housings. Murrelektronik's Eurocard holders are designed to mount Eurocards on DIN rails in the cabinet.

In control systems, units are used which require analog control signals (i.e. 0...10 V DC). With these well designed MPOT potentiometer modules, it is simple, cheap and easy to solve your set-point problems. The diode modules of the MKS series are designed for decoupling and interference applications. The LED indicators are available with diameters of 3, 5, and 10 mm. With their compact design, they are suitable for installation in front panels or process flow diagrams.

### Eurocard Holders



SKT

*An overview of this product range  
can be found in our online shop*



SKP

*An overview of this product range  
can be found in our online shop*

### Control Modules



**Potentiometer modules**  
MPOT

*An overview of this product range  
can be found in our online shop*



**Diode modules**  
MKS-D, MKS-LDP, MKS-BCD

*An overview of this product range  
can be found in our online shop*



**Assembly modules**  
MKS-M, ML 14, MP

*An overview of this product range  
can be found in our online shop*



# 2

## INTERFACES

# 2

## INTERFACES

Front Panel Interfaces	2.1	
Control Cabinet Interfaces / Cable Entry Systems	2.2	
Hybrid Fieldbus Coupling	<i>An overview of this product range can be found in our online shop</i>	2.3
Lighting Elements	2.4	
Control Devices	2.5	
Modular Connection Systems (Modlink Vario)	2.6	
Heavy Duty Connectors (Modlink Heavy)	2.7	



# MODLINK MSDD FRONT PANEL INTERFACES

- PLC Service Port
- IP65 Protection; UL Type Rating 4, 4x, 12, 13
- Modular Inserts

## DESIGN YOUR OWN PART – WITH OUR ARTICLE NUMBERS

The article numbers help you figure out whether you are ordering outlets, data connector inserts, individual frames or sets. The article numbers of the individual components can be found on the following pages. Both modules and sets can be ordered in quantities of 1 or more.

### THE SET

The set article number is made up of A, B, C and D.

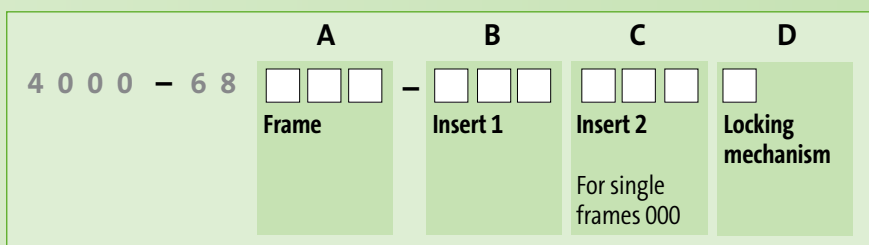

First select your components:

**Block A:** Frame (for example 4000-68**522**-000 0001 for transparent double frame)

**Block B:** Insert 1 (for example 4000-68000-**001** 0000 for Germany (VDE) gray)

**Block C:** Insert 2 (for example 4000-68000-**091** 0000 for 2× RJ45 + 2× USB)

**Block D:** Locking mechan. (for example 4000-68522-000 000**1** for 3 mm double-bit key)

The article number for this example set will be:

4 0 0 0 - 6 8    -

## Modlink MSDD Front Panel Interfaces

**Frames**

- Single and double frames

*Page 2.1.1*

**Inserts**

- Power outlets
- Data connection inserts

*Page 2.1.2*

**Built-in Sockets**

- USB
- RJ45

*Page 2.1.14*







**Modlink MSDD Front Panel Interfaces**

*An overview of this product range can be found in our online shop*







# FRONT PANEL INTERFACES

Frames (plastic)			Art-No.
	<b>1-way transparent</b>	cURus	
	Mounting frame plastic, PA black Lid: plastic, PC transparent	Closure: 3 mm double bit with attachable rotation knob	4000-68512-0000001
	Mounting frame plastic, PA black Lid: plastic, PC transparent	Closure: Daimler	4000-68512-0000003
	<b>1-way metallic</b>	cURus	
	Mounting frame plastic, PA black Lid: plastic, ABS gray	Closure: 3 mm double bit with attachable rotation knob	4000-68513-0000001
	Mounting frame plastic, PA black Lid: plastic, ABS gray	Closure: Daimler	4000-68513-0000003
	<b>1-way gray</b>	cURus	
	Mounting frame plastic, PA black Lid: plastic, PBT gray	Closure: 3 mm double bit with attachable rotation knob	4000-68514-0000001
	Mounting frame plastic, PA black Lid: plastic, PBT gray	Closure: Daimler	4000-68514-0000003
	<b>2-way transparent</b>	cURus	
	Mounting frame plastic, PA black Lid: plastic, PC transparent	Closure: 3 mm double bit with attachable rotation knob	4000-68522-0000001
	Mounting frame plastic, PA black Lid: plastic, PC transparent	Closure: Daimler	4000-68522-0000003
	<b>2-way metallic</b>	cURus	
	Mounting frame plastic, PA black Lid: plastic, ABS gray	Closure: 3 mm double bit with attachable rotation knob	4000-68523-0000001
	Mounting frame plastic, PA black Lid: plastic, ABS gray	Closure: Daimler	4000-68523-0000003
	<b>2-way gray</b>	cURus	
	Mounting frame plastic, PA black Lid: plastic, PBT gray	Closure: 3 mm double bit with attachable rotation knob	4000-68524-0000001
	Mounting frame plastic, PA black Lid: plastic, PBT gray	Closure: Daimler	4000-68524-0000003

## FRONT PANEL INTERFACES

Power outlets			Art-No.
	<p><b>Germany (VDE) white</b> Screw terminals: max. 6 mm<sup>2</sup> Operating voltage: 250 V AC Operating current: 16 A</p>	LED (yellow)	4000-68000-0010000
	<p><b>Germany (VDE) white</b> Spring clamp terminals: max. 2.5 mm<sup>2</sup> (AWG 14) Operating voltage: 250 V AC Operating current: 16 A</p>		4000-68000-0160000
	<p><b>Germany (VDE) yellow</b> Screw terminals: max. 6 mm<sup>2</sup> Operating voltage: 250 V AC Operating current: 16 A</p>		4000-68000-0020000
	<p><b>France (UTE-NF) gray</b> Screw terminals: max. 6 mm<sup>2</sup> Operating voltage: 250 V AC Operating current: 16 A</p>	LED (yellow)	4000-68000-0050000
	<p><b>France (UTE-NF) white</b> Screw terminals: max. 2 × 4 mm<sup>2</sup> (AWG 12) Operating voltage: 250 V AC Operating current: 16 A</p>		4000-68000-3010000
	<p><b>USA (NEMA 5-15) white</b> Screw terminals: max. 2.5 mm<sup>2</sup> (AWG 14) Operating voltage: 125 V AC Operating current: 15 A</p>	cURus	4000-68000-3240000
	<p><b>USA (2 × NEMA-GFCI 5-15)</b> Screw terminals: max. 2.5 mm<sup>2</sup> (AWG 14) Operating voltage: 125 V AC Operating current: 15 A</p>	cURus	4000-68000-3220000

# FRONT PANEL INTERFACES







Power outlets			Art-No.
	<p><b>USA (2 × NEMA-GFCI 5-20)</b> Screw terminals: max. 6 mm<sup>2</sup> Operating voltage: 125 V AC Operating current: max. 20 A per socket</p>	cURus	4000-68000-3280000
	<p><b>England (BS)</b> Screw terminals: max. 4 mm<sup>2</sup> Operating voltage: 250 V AC Operating current: max. 13 A</p>	with touch protection	4000-68000-0060000
	<p><b>England (BS) orange</b> Screw terminals: max. 4 mm<sup>2</sup> Operating voltage: 250 V AC Operating current: max. 13 A</p>		4000-68000-0190000
	<p><b>Italy (CEI 23-16)</b> Screw terminals: max. 2.5 mm<sup>2</sup> (AWG 14) Operating voltage: 250 V AC Operating current: 16 A</p>	Double	4000-68000-0070000
	<p><b>Italy (CEI 23-16)</b> Screw terminals: max. 2.5 mm<sup>2</sup> (AWG 14) Operating voltage: 250 V AC Operating current: 16 A</p>		4000-68000-0180000
	<p><b>Denmark</b> Spring clamp terminals: max. 2.5 mm<sup>2</sup> (AWG 14) Operating voltage: 250 V AC Operating current: max. 10 A</p>		4000-68000-0170000
	<p><b>Swiss</b> Spring clamp terminals: max. 1.5 mm<sup>2</sup> (AWG 16) Operating voltage: 250 V AC Operating current: max. 10 A</p>		4000-68000-0120000

## FRONT PANEL INTERFACES







Power outlets			Art-No.
	<p><b>Australia</b> Screw terminals: max. 2.5 mm<sup>2</sup> (AWG 14) Operating voltage: 250 V AC Operating current: max. 10 A</p>		4000-68000-0090000
	<p><b>India (IS 1293)</b> Screw terminals: max. 4 mm<sup>2</sup> Operating voltage: 240 V AC Operating current: max. 5 A</p>		4000-68000-3210000
	<p><b>China (CCC)</b> Screw terminals: max. 4 mm<sup>2</sup> Operating voltage: 250 V AC Operating current: max. 10 A</p>		4000-68000-3250000
	<p><b>Brazil</b> Screw terminals: max. 2.5 mm<sup>2</sup> (AWG 14) Operating voltage: 250 V AC Operating current: max. 10 A</p>	Double	4000-68000-3290000
	<p><b>Brazil</b> Screw terminals: max. 2.5 mm<sup>2</sup> (AWG 14) Operating voltage: 250 V AC Operating current: max. 10 A</p>	Single	4000-68000-3310000









# FRONT PANEL INTERFACES

Communication inserts			Art-No.
	<p><b>SUB-D15 HD; RJ45; USB; USB (formA)</b>                      1 × SUB-D15 HD (female/male) VGA                      1 × RJ45, 8-pole metal, CAT5e (female/female)                      2 × USB (female/female) form A</p>	<p>cURus shielded</p>	<p>4000-68000-1040000</p>
	<p><b>RJ45; RJ45; USB (formA)</b>                      2 × RJ45, 8-pole metal, CAT5e (female/female)                      1 × USB (female/female) form A</p>	<p>cURus shielded</p>	<p>4000-68000-0940000</p>
	<p><b>RJ45; USB (form A); DVI</b>                      1 × RJ45, 8-pole metal, CAT5e (female/female)                      1 × USB (female/female) form A                      1 × DVI (female/female)</p>		<p>4000-68000-0820000</p>
	<p><b>RJ45; RJ45; USB; USB (form A)</b>                      2 × RJ45, 8-pole metal, CAT5e (female/female)                      2 × USB (female/female/0.7 m cable) form A</p>	<p>shielded</p>	<p>4000-68000-0990000</p>
	<p><b>RJ45; RJ12; USB; USB (form A)</b>                      1 × RJ45, 8-pole metal, CAT5e (female/female)                      1 × RJ12, 6-pole plastic                      2 × USB (female/female) form A</p>	<p>cURus shielded</p>	<p>4000-68000-0910000</p>
	<p><b>RJ45; USB; USB (form A)</b>                      1 × RJ45, 8-pole metal, CAT5e (female/female)                      2 × USB (female/female) form A</p>	<p>shielded</p>	<p>4000-68000-0960000</p>
	<p><b>RJ45; RJ45; USB; USB (form A)</b>                      2 × RJ45, 8-pole metal, CAT5e (female/female)                      2 × USB (female/female) form A</p>	<p>shielded</p>	<p>4000-68000-0970000</p>





## FRONT PANEL INTERFACES







Communication inserts			Art-No.
	<b>RJ45; SUB-D9; SUB-D9</b> 1 × RJ45, 8-pole metal, CAT5e (female/female) 1 × SUB-D9 (female/female) 1 × SUB-D9 (male/male)	cURus	4000-68000-1110000
	<b>RJ45; RJ45</b> 2 × RJ45, 8-pole metal, CAT5e (female/female)	cURus shielded	4000-68000-1200000
	<b>RJ45</b> 1 × RJ45, 8-pole metal, CAT5e (female/female) 1 × SUB-D9 (blind plug)	cURus	4000-68000-1210000
	<b>RJ45; RJ45; RJ45; RJ45</b> 4 × RJ45, 8-pole metal, CAT5e (female/female)	shielded	4000-68000-1220000
	<b>USB (form A); RJ45</b> 1 × USB (female/female) form A 1 × RJ45, 8-pole metal, CAT5e (female/female)	cURus shielded	4000-68000-1310000
	<b>RJ45; SUB-D9</b> 1 × RJ45, 8-pole metal, CAT5e (female/female) 1 × SUB-D9 (female/female)	cURus shielded	4000-68000-1410000
	<b>SUB-D9; RJ45; USB (form A)</b> 1 × SUB-D9 (female/female) 1 × RJ45, 8-pole metal, CAT5e (female/female) 1 × USB (female/female/0.7 m cable) form A	shielded	4000-68000-1420000

# FRONT PANEL INTERFACES







Communication inserts			Art-No.
	<p><b>RJ45; USB (form A); SUB-D9</b>                      1 × RJ45, 8-pole metal, CAT5e (female/female)                      1 × USB (female/female) form A                      1 × SUB-D9 (female/male)</p>	<p>cURus                      shielded</p>	<p>4000-68000-1430000</p>
	<p><b>RJ45; USB (form A); SUB-D9</b>                      1 × RJ45, 8-pole metal, CAT5e (female/female)                      1 × USB (female/female) form A                      1 × SUB-D9 (female/female)</p>	<p>cURus                      shielded</p>	<p>4000-68000-1440000</p>
	<p><b>RJ45; RJ45; SUB-D9</b>                      2 × RJ45, 8-pole metal, CAT5e (female/female)                      1 × SUB-D9 (female/male)</p>	<p>shielded</p>	<p>4000-68000-1620000</p>
	<p><b>RJ45; SUB-D9; SUB-D25</b>                      1 × RJ45, 8-pole metal, CAT5e (female/female)                      1 × SUB-D9 (female/male)                      1 × SUB-D25 (female/male)</p>	<p>cURus</p>	<p>4000-68000-1700000</p>
	<p><b>BNC; RJ45; SUB-D9</b>                      1 × BNC (female/female)                      1 × RJ45, 8-pole metal, CAT5e (female/female)                      1 × SUB-D9 (female/male)</p>	<p>shielded</p>	<p>4000-68000-1800000</p>
	<p><b>BNC; RJ45; SUB-D9</b>                      1 × BNC (female/female)                      1 × RJ45, 8-pole metal, CAT5e (female/female)                      1 × SUB-D9 (female/female)</p>		<p>4000-68000-1810000</p>
	<p><b>USB (form A); SUB-D25; RJ45</b>                      1 × USB (female/female) form A                      1 × SUB-D25 (female/male)                      1 × RJ45, 8-pole metal, CAT5e (female/female)</p>	<p>cURus                      shielded</p>	<p>4000-68000-1450000</p>





## FRONT PANEL INTERFACES

Communication inserts			Art-No.
	<b>USB (form A); RJ45</b> 1 × USB (female/female/0.7 m cable) form A 1 × RJ45, 8-pole metal, CAT5e (female/female)	shielded	4000-68000-1300000
	<b>USB (form A); SUB-D9; RJ45</b> 1 × USB (female/female/0.7 m cable) form A 1 × SUB-D9 (female/male) 1 × RJ45, 8-pole metal, CAT5e (female/female)	shielded	4000-68000-1400000
	<b>USB; USB (form A)</b> 2 × USB (female/female/0.7 m cable) form A	shielded	4000-68000-0900000
	<b>USB (form A to A)</b> 1 × USB (female/female) form A	cURus shielded	4000-68000-0920000
	<b>USB (form A); USB (form A)</b> 2 × USB (female/female) form A	cURus shielded	4000-68000-0930000
	<b>USB; USB; USB; USB (form A)</b> 4 × USB (female/female) form A		4000-68000-0950000
	<b>USB (form A); DVI</b> 2 × USB (female/female) form A 1 × DVI (female/female)		4000-68000-1280000



Combinations			Art-No.
	<p><b>Germany (VDE)</b>                      1 × Germany (VDE) white                      2 × data cut-out</p>	<p>Spring clamp terminals: max. 2 × 2.5 mm<sup>2</sup> (AWG 14)                      Operating voltage: 250 V AC                      Operating current: 16 A                      shielded</p>	<p><b>4000-68000-4500000</b></p>
	<p><b>Germany (VDE) white; RJ45</b>                      1 × Germany (VDE) white                      1 × RJ45, 8-pole metal, CAT6A (female/female)                      1 × data cut-out</p>	<p>Spring clamp terminals: max. 2 × 2.5 mm<sup>2</sup> (AWG 14)                      Operating voltage: 250 V AC                      Operating current: 16 A                      shielded</p>	<p><b>4000-68000-4500001</b></p>
	<p><b>Germany (VDE) white; RJ45</b>                      1 × Germany (VDE) white                      2 × RJ45, 8-pole metal, CAT6A (female/female)</p>	<p>Spring clamp terminals: max. 2 × 2.5 mm<sup>2</sup> (AWG 14)                      Operating voltage: 250 V AC                      Operating current: 16 A                      shielded</p>	<p><b>4000-68000-4500004</b></p>
	<p><b>Germany (VDE) orange; RJ45</b>                      1 × Germany (VDE) orange                      1 × RJ45, 8-pole metal, CAT6A (female/female)                      1 × data cut-out</p>	<p>Spring clamp terminals: max. 2 × 2.5 mm<sup>2</sup> (AWG 14)                      Operating voltage: 250 V AC                      Operating current: 16 A                      shielded</p>	<p><b>4000-68000-4620001</b></p>
	<p><b>France (UTE-NF); RJ45</b>                      1 × France (UTE-NF) white                      1 × RJ45, 8-pole metal, CAT6A (female/female)                      1 × data cut-out</p>	<p>Screw terminals: max. 2 × 4 mm<sup>2</sup> (AWG 12)                      Operating voltage: 250 V AC                      Operating current: 16 A                      shielded</p>	<p><b>4000-68000-4510001</b></p>
	<p><b>France (UTE-NF)</b>                      1 × France (UTE-NF) white                      2 × data cut-out</p>	<p>Screw terminals: max. 2 × 4 mm<sup>2</sup> (AWG 12)                      Operating voltage: 250 V AC                      Operating current: 16 A                      shielded</p>	<p><b>4000-68000-4510000</b></p>
	<p><b>USA (NEMA 5-15); RJ45; USB (form A)</b>                      1 × NEMA 5-15 (plug-solder connection)                      1 × RJ45, 8-pole metal, CAT5e (female/female)                      1 × USB (female/female) form A</p>	<p>cURus</p>	<p><b>4000-68000-4030000</b></p>

## FRONT PANEL INTERFACES

Combinations			Art-No.
	<p><b>USA (NEMA 5-15); RJ45</b>            1 × NEMA 5-15 (plug-solder connection)            1 × RJ45, 8-pole metal, CAT5e (female/female)</p>	cURus	4000-68000-4040000
	<p><b>England (BS)</b>            1 × Great Britain (BS)            2 × data cut-out</p>	Screw terminals: max. 2 × 4 mm <sup>2</sup> (AWG 12) Operating voltage: 250 V AC Operating current: max. 13 A shielded	4000-68000-4520000
	<p><b>Great Britain (BS); RJ45</b>            1 × Great Britain (BS)            1 × RJ45, 8-pole metal, CAT6A (female/female)            1 × data cut-out</p>	Screw terminals: max. 2 × 4 mm <sup>2</sup> (AWG 12) Operating voltage: 250 V AC Operating current: max. 13 A shielded	4000-68000-4520001
	<p><b>Italy (CEI 23-16)</b>            1 × Italy (CEI 23-16)            2 × data cut-out</p>	Screw terminals: max. 2 × 4 mm <sup>2</sup> (AWG 12) Operating voltage: 250 V AC Operating current: 16 A shielded	4000-68000-4530000
	<p><b>Italy (CEI 23-16); RJ45</b>            1 × Italy (CEI 23-16)            1 × RJ45, 8-pole metal, CAT6A (female/female)            1 × data cut-out</p>	Screw terminals: max. 2 × 4 mm <sup>2</sup> (AWG 12) Operating voltage: 250 V AC Operating current: 16 A shielded	4000-68000-4530001
	<p><b>Italy (CEI 23-16); SUB-D9</b>            1 × Italy (CEI 23-16)            1 × SUB-D9 (male/female)            1 × SUB-D9 cut-out</p>	Screw terminals: max. 2 × 4 mm <sup>2</sup> (AWG 12) Operating voltage: 250 V AC Operating current: 16 A shielded	4000-68000-4530004
	<p><b>Denmark</b>            1 × Denmark (white)            2 × data cut-out</p>	Spring clamp terminals: max. 2 × 2.5 mm <sup>2</sup> (AWG 14) Operating voltage: 250 V AC Operating current: max. 13 A shielded	4000-68000-4550000









Combinations			Art-No.
	<p><b>Denmark</b>                      1 × Denmark (white)                      1 × RJ45, 8-pole metal, CAT6A (female/female)                      1 × data cut-out</p>	<p>Spring clamp terminals: max. 2 × 2.5 mm<sup>2</sup> (AWG 14)                      Operating voltage: 250 V AC                      Operating current: max. 13 A                      shielded</p>	<p><b>4000-68000-4550001</b></p>
	<p><b>Swiss</b>                      1 × Swiss                      2 × data cut-out</p>	<p>Spring clamp terminals: max. 2 × 1.5 mm<sup>2</sup> (AWG 16)                      Operating voltage: 250 V AC                      Operating current: max. 10 A                      shielded</p>	<p><b>4000-68000-4540000</b></p>
	<p><b>Swiss; RJ45</b>                      1 × Swiss                      1 × RJ45, 8-pole metal, CAT6A (female/female)                      1 × data cut-out</p>	<p>Spring clamp terminals: max. 2 × 1.5 mm<sup>2</sup> (AWG 16)                      Operating voltage: 250 V AC                      Operating current: max. 10 A                      shielded</p>	<p><b>4000-68000-4540001</b></p>
	<p><b>India (IS 1293)</b>                      1 × India (white)                      2 × data cut-out</p>	<p>Screw terminals: max. 2 × 1.5 mm<sup>2</sup> (AWG 16)                      Operating voltage: 240 V AC                      Operating current: max. 5 A                      shielded</p>	<p><b>4000-68000-4570000</b></p>
	<p><b>India (IS 1293); RJ45</b>                      1 × India (white)                      1 × RJ45, 8-pole metal, CAT6A (female/female)                      1 × data cut-out</p>	<p>Screw terminals: max. 2 × 1.5 mm<sup>2</sup> (AWG 16)                      Operating voltage: 240 V AC                      Operating current: max. 5 A                      shielded</p>	<p><b>4000-68000-4570001</b></p>
	<p><b>China (CCC)</b>                      1 × China (white)                      2 × data cut-out</p>	<p>Screw terminals: max. 2 × 4 mm<sup>2</sup> (AWG 12)                      Operating voltage: 250 V AC                      Operating current: max. 10 A                      shielded</p>	<p><b>4000-68000-4580000</b></p>
	<p><b>China (CCC); RJ45</b>                      1 × China (white)                      1 × RJ45, 8-pole metal, CAT6A (female/female)                      1 × data cut-out</p>	<p>Screw terminals: max. 2 × 4 mm<sup>2</sup> (AWG 12)                      Operating voltage: 250 V AC                      Operating current: max. 10 A                      shielded</p>	<p><b>4000-68000-4580001</b></p>

## FRONT PANEL INTERFACES



Combinations			Art-No.
	<b>Brazil</b> 1 × Brazil 4 × data cut-out	Screw terminals: max. 2 × 1.5 mm <sup>2</sup> (AWG 16) Operating voltage: 250 V AC Operating current: max. 10 A	<b>4000-68000-4610000</b>
	<b>Brazil; RJ45</b> 1 × Brazil 1 × RJ45, 8-pole metal, CAT6A (female/female) 3 × data cut-out	Screw terminals: max. 2 × 1.5 mm <sup>2</sup> (AWG 16) Operating voltage: 250 V AC Operating current: max. 10 A shielded	<b>4000-68000-4610001</b>
	<b>Brazil; SUB-D9</b> 1 × Brazil 1 × SUB-D9 (male/female) 1 × SUB-D9 cut-out	Screw terminals: max. 2 × 1.5 mm <sup>2</sup> (AWG 16) Operating voltage: 250 V AC Operating current: max. 10 A shielded	<b>4000-68000-4610004</b>
	<b>Germany (VDE); RJ45; FI-cut-out</b> 1 × VDE 1 × RJ45, 8-pole metal, CAT5e (female/female) 1 × FI cut-out		<b>4000-68000-4300001</b>
	<b>Germany (VDE) yellow; RJ45; FI-cut-out</b> 1 × VDE yellow 1 × RJ45, 8-pole metal, CAT5e (female/female) 1 × FI cut-out		<b>4000-68000-4390001</b>
	<b>France (UTE-NF); RJ45; FI-cut-out</b> 1 × France (UTE-NF) white 1 × RJ45, 8-pole metal, CAT5e (female/female) 1 × FI cut-out		<b>4000-68000-4310001</b>
	<b>USA (2 × NEMA-GFCI 5-15); RJ45; USB (form A); fuse</b> 2 × NEMA-GFCI 5-15 (screw terminals) 1 × RJ45, 8-pole metal, CAT5e (female/female) 1 × USB (female/female) form A 1 × fuse (3 A)	cURus with touch protection	<b>4000-68000-4100000</b>



# FRONT PANEL INTERFACES

Combinations			Art-No.
	<b>USA (2 × NEMA-GFCI 5-15); RJ45; fuse</b> 2 × NEMA-GFCI 5-15 (screw terminals) 1 × RJ45, 8-pole metal, CAT5e (female/female) 1 × fuse (3 A)	cURus with touch protection	4000-68000-4110000
	<b>USA (2 × NEMA-GFCI 5-15); RJ45; RJ45; fuse</b> 2 × NEMA-GFCI 5-15 (screw terminals) 2 × RJ45, 8-pole metal, CAT5e (female/female) 1 × fuse (3 A)	cURus with touch protection	4000-68000-4120000
	<b>USA (2 × NEMA-GFCI 5-15); RJ45; SUB-D9; fuse</b> 2 × NEMA-GFCI 5-15 (screw terminals) 1 × RJ45, 8-pole metal, CAT5e (female/female) 1 × SUB-D9 (male/female) 1 × fuse (3 A)	cURus with touch protection	4000-68000-4130000
	<b>USA (2 × NEMA-GFCI 5-15); fuse</b> 2 × NEMA-GFCI 5-15 (screw terminals) 1 × fuse (3 A)	cURus with touch protection	4000-68000-4140000
	<b>Great Britain (BS); RJ45; FI cut-out</b> 1 × Great Britain (BS) 1 × RJ45, 8-pole metal, CAT5e (female/female) 1 × FI cut-out		4000-68000-4320001
	<b>Italy (CEI 23-16); RJ45; FI cut-out</b> 1 × Italy (CEI 23-16) 1 × RJ45, 8-pole metal, CAT5e (female/female) 1 × FI cut-out		4000-68000-4330001
	<b>Swiss; RJ45; FI cut-out</b> 1 × Swiss 1 × RJ45, 8-pole metal, CAT5e (female/female) 1 × FI cut-out		4000-68000-4340001
	<b>Australia; RJ45; FI cut-out)</b> 1 × Australia 1 × RJ45, 8-pole metal, CAT5e (female/female) 1 × FI cut-out		4000-68000-4360001

## FRONT PANEL INTERFACES

Pass-through			Art-No.
	<b>Pass-through</b> 1 × RJ45, 8-pole metal, CAT5e (female/female)	cULus	4000-73000-0010000
	<b>Pass-through</b> 1 × USB 3.0 (female/male) form A, 0.6 m cable 1 × USB 3.0 (female/male) form A, 1.0 m cable 1 × USB 3.0 (female/male) form A, 1.5 m cable 1 × USB 3.0 (female/male) form A, 2.0 m cable	cULus cULus cULus cULus	4000-73000-0150000 4000-73000-0160000 4000-73000-0170000 4000-73000-0180000

# FRONT PANEL INTERFACES

Connection accessories			Art-No.
	<b>Gender Changer</b> RJ45 (female /female)	cURus	4000-68000-9040010
	<b>Gender Changer</b> RJ12; (female/female)		4000-68000-9040011
	<b>Gender Changer</b> RJ45 (female /female) Zinc die casting, nickel-plated	cURus	4000-68000-9040012
	<b>Gender Changer</b> USB (form A) 3.0 (female/female)		4000-68000-9040022
	<b>Gender Changer</b> SUB-D9 (female/female)	cURus	4000-68000-9040030
	SUB-D9 (female/male)	cURus	4000-68000-9040031
	<b>Gender Changer</b> SUB-D9 (male/male)	cURus	4000-68000-9040032
	<b>Gender Changer</b> SUB-D15 (female/male)	cURus	4000-68000-9040040
	SUB-D15 (female/female)	cURus	4000-68000-9040041
	<b>Gender Changer</b> SUB-D15 (male/male)	cURus	4000-68000-9040042
	<b>Gender Changer</b> SUB-D15 HD (female/male) VGA	cURus	4000-68000-9040045

## FRONT PANEL INTERFACES

Connection accessories			Art-No.
	<b>Gender Changer</b>		
	SUB-D25 (female/female)	cURus	4000-68000-9040050
	SUB-D25 (female/male)	cURus	4000-68000-9040051
	<b>Cables</b>		
	SUB-D9 (male/male); 2 m	shielded	4000-68000-9030010
	SUB-D9 (male/male); 5 m	shielded	4000-68000-9030011
	SUB-D9 (female/male); 2 m	shielded	4000-68000-9030020
	SUB-D9 (female/male); 5 m	shielded	4000-68000-9030021
	<b>Cables</b>		
	SUB-D25 (female/male); 1.8 m	shielded	4000-68000-9030040
	SUB-D25 (female/male); 5 m	shielded	4000-68000-9030041
	<b>Cables</b>		
	USB (form A to A); 2 m (male/male)	shielded	4000-68000-9030050
	USB (form A to A); 5 m (male/male)	shielded	4000-68000-9030051
	USB (form A to A); 2 m (male/male) PUR	shielded	4000-68000-9030052
	USB (form A to A); 5 m (male/male) PUR	shielded	4000-68000-9030053
	USB (form A to B); 2 m	shielded	4000-68000-9030054
	USB (form A to B); 5 m	shielded	4000-68000-9030055
	<b>Cables</b>		
	RJ45 (8/8-pole) metal, CAT6; 2 m	shielded	4000-68000-9030060
	RJ45 (8/8-pole) metal, CAT6; 5 m	shielded	4000-68000-9030061
	RJ45 (8/8-pole) metal, CAT6; 10 m	shielded	4000-68000-9030062
Mounting accessories			Art-No.
	<b>Ground strap 6 mm<sup>2</sup></b>		
	100 mm for screw (M4)		4000-71001-0610004
	200 mm for screw (M4)		4000-71001-0620004
	300 mm for screw (M4)		4000-71001-0630004
	<b>Blind plate (flat)</b>		
	Self-installation available space: 45 × 75 mm	cURus	4000-68000-8900000
	<b>Blind plate (depth)</b>		
	Self-installation available space: 34 × 58 mm Cavity: 13 mm deep	cURus	4000-68000-8910000

Mounting accessories			Art-No.
	<p><b>Blind plates (pre-cut)</b> 1 × USB, 1 × RJ45, SUB-D9</p>	<p>cURus shielded</p>	<p>4000-68000-8500000</p>
	<p><b>Blind plates (pre-cut)</b> 1 × USB, 1 × RJ45, 1 × SUB-D25</p>	<p>cURus shielded</p>	<p>4000-68000-8510000</p>
	<p><b>Housing (1-way)</b> with 4 blind plugs (M16 × 1.5) H × W × D: 180×94×81 mm</p>		<p>4000-68000-9060010</p>
	<p><b>Housing (2-way)</b> with 6 blind plugs (M16 × 1.5) H × W × D: 182×180×90 mm</p>		<p>4000-68000-9060020</p>
	<p><b>Touch protection box</b> for double frame H × W × D: 124×124×67 mm</p>	<p>cURus</p>	<p>4000-68000-9140000</p>
	<p><b>Touch protection box</b> for single frame H × W × D: 115×87×66 mm</p>	<p>cURus</p>	<p>4000-68000-9180000</p>
	<p><b>Cable compression gland M16</b></p>	<p>Sealing range (cable Ø): 4...8 mm</p>	<p>4000-68000-9060030</p>
	<p><b>Label plate</b> Frame: 20 pcs</p>	<p>cURus</p>	<p>4000-68000-9000000</p>

# CONTROL CABINET INTERFACES / CABLE ENTRY SYSTEMS

- Durable connections
- Modular system
- High protection degree

## MODLINK MPV CABLE ENTRY SYSTEM

The article numbers help you figure out whether you are ordering inserts, individual frames or sets. A set has one part number for up to three components.

### THE MODLINK MPV SET

The set article number is made up of **A**, **B** and **C**.

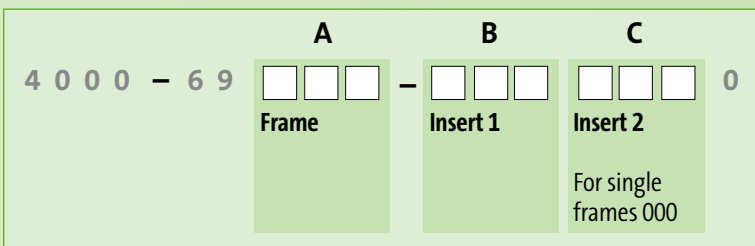

First select your components:

- Block A:** Frame (e. g. 4000-69**122**-000 0000 for double frame)  
**Block B:** Insert 1 (e. g. 4000-69000-**100** 0000 for M12 / SUB-D)  
**Block C:** Insert 2 (e. g. 4000-69000-**200** 0000 for 7/8" / spring clamp terminal)

The article number for this example set will be:

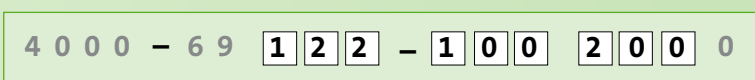

## Control Cabinet Interfaces



### Modlink MPV – modular

- Frames
- Inserts
- Accessories

Page 2.2.1

## Cable Entry Systems



### Cable entry system – modular

- Cable entry plate
- Inserts

Page 2.2.3



### Cable entry system – predefined

- Rectangular
- Round

Page 2.2.4

MPV Frame		Art-No.
	<b>Single</b> for standard cut-out Size 6 (35 × 52 mm) IP65	cURus  4000-69112-0000000
	<b>Double</b> for standard cut-out Size 24 (35 × 112 mm) IP65	cURus  4000-69122-0000000
	<b>Single (30°-angle)</b> for standard cut-out Size 6 (35 × 52 mm) IP65	cURus  4000-69212-0000000
	<b>Double (30°-angle)</b> for standard cut-out Size 24 (35 × 112 mm) IP65	cURus  4000-69222-0000000
MPV Inserts		Art-No.
	<b>M12</b> M12 (male/female) 5-pole IP65	cURus  4000-69000-1040000
	M12 (male/female) 5-pole, B-coded IP65	cURus  4000-69000-1060000
	M12 (male/female) 6-pole, Cube67 IP65	cURus  4000-69000-1080000
	<b>M12; SUB-D9</b> M12 (female) B-coded SUB-D9 (female) IP65	cURus  4000-69000-1000000
	<b>M12; terminators</b> M12 (female) 5-pole, A-coded Spring clamp terminal connection IP65	  4000-69000-1050000

## CONTROL CABINET INTERFACES / CABLE ENTRY SYSTEMS

MPV Inserts			Art-No.
	<p><b>M12; terminators</b> M12 (female) 5-pole, A-coded Screw terminal connection (yellow) Safety IP65</p>		4000-69000-1090000
	<p><b>M12; RJ45</b> M12 (female) 4-pole, D-coded RJ45 (8/8-pole) metal, CAT6 IP65</p>		4000-69000-1100000
	<p><b>7/8"; Spring clamp terminal</b> 7/8" (female) Spring clamp terminal connection IP65</p>	cURus	4000-69000-2000000
	<p><b>7/8"; Spring clamp terminal</b> 7/8" (male) Spring clamp terminal connection</p>		4000-69000-2040000
	<p><b>RJ45</b> RJ45 (8/8-pole) metal, CAT6 IP65</p>	cURus	4000-69000-2500000
	<p><b>LWL</b> Fiber Optic (male/male) single mode IP65</p>		4000-69000-5200000
MPV accessories			Art-No.
	<p><b>Blind insert</b> for sealing of unused openings IP65</p>	cURus	4000-69000-9000000



# CONTROL CABINET INTERFACES / CABLE ENTRY SYSTEMS

MPV accessories			Art-No.
	<b>RJ45</b> Male straight, 4-pole IP65		4000-69000-9500050
	<b>RJ45</b> Male 90°, 4-pole IP65		4000-69000-9500060
	<b>Control cabinet entry system M12</b> straight, A-coded, 5-pole, shielded straight, B-coded, 5-pole, shielded straight, A-coded, 6-pole, shielded	DeviceNet, CANopen PROFIBUS, Interbus Cube67	7000-42111-0000000 7000-44111-0000000 7000-46111-0000000
	<b>Control cabinet entry system M12</b> straight, D-coded, 4-pole, shielded (female/female)	Ethernet CAT5	7000-44611-0000000
Connectors			Art-No.
	<b>Size 16</b> for 4 cables (0 large, 4 small) for 5 cables (1 large, 4 small) for 8 cables (0 large, 8 small)		4000-70103-0004000 4000-70103-0104000 4000-70103-0008000
	<b>Size 24</b> for 4 cables (2 large, 2 small) for 7 cables (1 large, 6 small) for 10 cables (0 large, 10 small)		4000-70103-0202000 4000-70103-0106000 4000-70103-0010000

# CONTROL CABINET INTERFACES / CABLE ENTRY SYSTEMS

Cable entry glands		Art-No.
	<b>with cable tie eye</b>	
	Cable diameter (3...4 mm)	4000-70403-0001030
	Cable diameter (4...5 mm)	4000-70403-0001040
	Cable diameter (5...6 mm)	4000-70403-0001050
	Cable diameter (6...7 mm)	4000-70403-0001060
	Cable diameter (7...8 mm)	4000-70403-0001070
	Cable diameter (8...9 mm)	4000-70403-0001080
	Cable diameter (9...10 mm)	4000-70403-0001090
	Cable diameter (10...11 mm)	4000-70403-0001100
	Cable diameter (11...12 mm)	4000-70403-0001110
	Cable diameter (12...13 mm)	4000-70403-0001120
	Cable diameter (13...14 mm)	4000-70403-0001130
	Cable diameter (14...15 mm)	4000-70403-0001140
	Cable diameter (15...16 mm)	4000-70403-0001150
	Cable diameter (16...17 mm)	4000-70403-0100160
	Cable diameter (17...18 mm)	4000-70403-0100170
	Cable diameter (18...19 mm)	4000-70403-0100180
	Cable diameter (19...20 mm)	4000-70403-0100190
	Cable diameter (20...21 mm)	4000-70403-0100200
	Cable diameter (21...22 mm)	4000-70403-0100210
	Cable diameter (22...23 mm)	4000-70403-0100220
	Cable diameter (23...24 mm)	4000-70403-0100230
Cable diameter (24...25 mm)	4000-70403-0100240	
Cable diameter (24...25 mm)	4000-70403-0100250	
Cable diameter (26...27 mm)	4000-70403-0100260	
Cable diameter (27...28 mm)	4000-70403-0100270	
Cable diameter (28...29 mm)	4000-70403-0100280	
Cable diameter (29...30 mm)	4000-70403-0100290	
Cable diameter (30...31 mm)	4000-70403-0100300	
	<b>Special</b>	
	Blind plug (plugs) single	4000-70503-0001010
	Blind plug (plugs) double	4000-70503-0100010
	Adapter	4000-70503-0100020
	for 1 AS-Interface cable	4000-70503-0001020
	for 2 AS-Interface cables	4000-70503-0001030
	for 2 cables (Ø 6 mm)	4000-70503-0001060
for 2 cables (Ø 5 mm)	4000-70503-0001050	
<b>Plates</b>		<b>Art-No.</b>
	<b>Size 24</b>	
	Cable diameter (12) × 8...12 mm	4000-70603-0240120
	Cable diameter (6) × 3...6.5 mm, (4) × 5...9.2 mm, (4) × 9.6...15.9 mm	4000-70603-0240140
	Cable diameter (17) × 5...9.2 mm	4000-70603-0240170
	Cable diameter (16) × 3...6.5 mm, (4) × 5...9.2 mm, (2) × 8...12.5 mm	4000-70603-0240220
	Cable diameter (23) × 4.3...8.1 mm	4000-70603-0240230
Cable diameter (29) × 3...6.5 mm	4000-70603-0240290	
	<b>M50</b>	
	Cable diameter (3) × 6...10 mm, (1) × 9.6...15.9 mm	4000-70703-0500040
	Cable diameter (1) × 3...5.5 mm, (5) × 5...9.2 mm	4000-70703-0500060
	Cable diameter (7) × 3...6.5 mm, (1) × 6...10 mm	4000-70703-0500080
Locknut	4000-70704-0500000	

Plates			Art-No.
	<b>M63</b> Cable diameter (2) × 3...6.5 mm, (4) × 5...9.2 mm, (2) × 9.6...15.9 mm		4000-70703-0630080
	Cable diameter (6) × 3...5.5 mm, (6) × 3...6.5 mm, (1) × 6...10 mm		4000-70703-0630130
	Cable diameter (19) × 3...5 mm		4000-70703-0630190
	Locknut		4000-70704-0630000
Accessories			Art-No.
	<b>Blind plate</b> Size 16		4000-70202-0001000
	<b>Blind plate</b> Size 24		4000-70202-0002000
	<b>Adapter</b> from size 24 to 16		4000-70203-0100000
	<b>Cable strain relief</b> for 1 cable		4000-70302-0000010
	for 5 cables		4000-70302-0000050
	for 9 cables		4000-70302-0000090
	<b>Label plate</b> 20 × 9 mm		4000-70920-0000000
	<b>Cable tie</b> for small glands L = 75 mm		4000-70902-0075220
	for large glands L = 160 mm		4000-70902-0160450
	for large glands L = 180 mm		4000-70902-0180800



# HYBRID FIELDBUS COUPLING

- For durable connections
- A high degree of protection
- Repeater included

## EASILY CONNECTED – QUICKLY AND SAFELY

MSDD hybrid fieldbus couplers transfer data and power from the cabinet into the industrial field. A repeater function amplifies and processes signals.

### Active hybrid fieldbus coupling offers many benefits:

- Repeater and control cabinet interface in one module
- PROFIBUS FMS/DP galvanically separated
- Three independent PROFIBUS ports
- All three PROFIBUS segments are galvanically separated
- Baud rate change during operation – automatic and continuous Baud rate detection
- 3 × segment length – 200 m at 1.5 Mbit/s and 100 m at 12 Mbit/s
- Cascading capabilities for 31 modules per PROFIBUS segment
- Integrated terminating resistor

## MSDD Hybrid Fieldbus Coupling



### Active Hybrid Fieldbus Coupling

Active connection between control cabinet and fieldbus area (incl. repeater)

*An overview of this product range can be found in our online shop*



### Passive Hybrid Fieldbus Coupling

Passive connection between control cabinet and fieldbus area

*An overview of this product range can be found in our online shop*



# LIGHTING ELEMENTS MAXIMUM FLEXIBILITY

- High light yield
- Long life
- Plug-in solutions

## DISTINCT SIGNALS AND PERFECT ILLUMINATION IN DAYLIGHT QUALITY

### Modlight Pro LED signal towers

The signal towers are characterized by maximum flexibility in color selection and color composition. The elements of the signal towers with diameters of 50 and 70 millimeters are connected by bayonet locks, making for easy and quick assembly. The signal towers can be flexibly mounted.

### Modlight Illumix LED machine light

The machine lights of the Modlight Illumix series ensure optimal illumination of machines and systems based on maintenance-free and durable LED technology in daylight quality. Rotatable mounting brackets provide flexibility in attaching the lights.

## Signal lights



### Modlight50 Pro / Modlight70 Pro

- 50/70 mm
- Connecting elements
- Buzzer modules
- LED modules

Page 2.4.1



### Sets – Modlight30 / Modlight50 Pro / Modlight70 Pro

- 30/50/70 mm
- LED signal towers

Page 2.4.2



### Comlight57

- 57 mm
- Single lights
- LED

Page 2.4.3

## Machine lights



### Modlight Illumix Slim Line

- Machine light (LED)
- Degree of protection IP54

### Modlight Illumix Classic Line

- Machine light (LED)
- Degree of protection IP67

Page 2.4.5



### Modlight Illumix Xtreme

- Machine light (LED)
- Degree of protection IP69K





Page 2.4.6

# LIGHTING ELEMENTS

Connection modules			Art-No.
	Base for floor mount Modlight50 Pro	Spring clamp terminals cURus	4000-76050-1100002
	Base for floor mount Modlight70 Pro	Spring clamp terminals cURus	4000-76070-1100002
	Basic for tube mounting Modlight50 Pro	Spring clamp terminals cURus	4000-76050-1100003
	Basic for tube mounting Modlight70 Pro	Spring clamp terminals cURus	4000-76070-1100003
	Basic Modlight70 Pro	M12 (8-pole), down	4000-76070-1300002
	Basic Modlight70 Pro	M12 (8-pole), sideways	4000-76070-1400002
	Basic with magnet base Modlight70 Pro	M12 (8-pole), sideways	4000-76070-1500002
Buzzer modules			Art-No.
	Buzzer module Modlight50 Pro		4000-76050-1100004
	Buzzer module Modlight70 Pro		4000-76070-1100004
LED modules			Art-No.
	LED module Modlight50 Pro	red	4000-76050-1011000
	LED module Modlight70 Pro	red	4000-76070-1011000
	LED module Modlight50 Pro	yellow	4000-76050-1012000
	LED module Modlight70 Pro	yellow	4000-76070-1012000

## LIGHTING ELEMENTS

LED modules			Art-No.
	LED module Modlight50 Pro	green	4000-76050-1013000
	LED module Modlight70 Pro	green	4000-76070-1013000
	LED module Modlight50 Pro	blue	4000-76050-1014000
	LED module Modlight70 Pro	blue	4000-76070-1014000
	LED module Modlight50 Pro	clear	4000-76050-1015000
	LED module Modlight70 Pro	clear	4000-76070-1015000
Sets			Art-No.
	<b>Modlight30 (green/yellow/red)</b>		
	Connection module + LED modules	Connection cable L = 300 mm	4000-75324-5310000
	Connection module + LED modules	Connection M12 (on bottom)	4000-75330-5310000
	<b>Modlight50 Pro (green/yellow/red)</b>		
	Basic + LED modules		4000-76501-5310000
	Basic, buzzer + LED modules		4000-76502-5310000
	<b>Modlight70 Pro (green/yellow/red)</b>		
	Basic + LED modules + M12 (down)		4000-76704-5310000
	Basic, buzzer + LED modules + M12 (down)		4000-76705-5310000
	<b>Modlight70 Pro (green/yellow/red)</b>		
	Basic + LED modules + M12 (side)		4000-76712-5310000
	Basic, buzzer + LED modules + M12 (side)		4000-76713-5310000

Compact status lights			Art-No.
	<b>Comilight57</b> red	Spring clamp terminal connection	4000-75057-1111000
	red	Connection M12 (on bottom)	4000-75057-1311000
	<b>Comilight57</b> yellow	Spring clamp terminal connection	4000-75057-1112000
	yellow	Connection M12 (on bottom)	4000-75057-1312000
	<b>Comilight57</b> green	Spring clamp terminal connection	4000-75057-1113000
	green	Connection M12 (on bottom)	4000-75057-1313000
	<b>Comilight57</b> blue	Spring clamp terminal connection	4000-75057-1114000
	blue	Connection M12 (on bottom)	4000-75057-1314000
	<b>Comilight57</b> clear	Spring clamp terminal connection	4000-75057-1115000
	clear	Connection M12 (on bottom)	4000-75057-1315000



## LIGHTING ELEMENTS

Accessories Modlight30			Art-No.
	<b>Adapter for wall assembly</b>		4000-75030-0000903
Accessories Modlight50/70 Pro			Art-No.
	<b>Bottom adapter for tube mounting</b>	for Modlight50/70 Pro	4000-76070-0000901
	<b>Adapter for tube/wall mounting</b>	for Modlight50/70 Pro	4000-76070-0000902
	<b>Adapter for wall assembly</b>	for Modlight70 Pro	4000-76070-0000903
	<b>Adapter for wall assembly</b> Cable outlet (on the bottom)	for Modlight70 Pro	4000-75070-0000904
	<b>Aluminum tube</b> 300 mm	for Modlight50/70 Pro	4000-76070-0000913
	800 mm	for Modlight50/70 Pro	4000-76070-0000918
	<b>Magnet base</b> with M16 × 1.5 gland	Sideways cable entry point for Modlight50/70 Pro	4000-75070-0000920
	<b>Magnet base</b> with M12 flange plug connector (8-pole)	Sideways connection for Modlight50/70 Pro	4000-75070-0000921

Accessories Modlight50/70 Pro			Art-No.
	<b>Mounting adapter</b> for strain relief	bottom or side exit	4000-75070-0000922
	<b>Label plate</b> transparent	for Modlight50 Pro	4000-76050-0000923
	transparent	for Modlight70 Pro	4000-76070-0000923
LED machine lights			Art-No.
	<b>Modlight Illumix Slim Line</b> 4 W - 24 V DC Connection M8	IP54 cULus	4000-75800-1715004
	8 W - 24 V DC Connection M8	IP54 cULus	4000-75800-1715008
	16 W - 24 V DC Connection M8	IP54 cULus	4000-75800-1715016
	24 W - 24 V DC Connection M8	IP54 cULus	4000-75800-1715024
	32 W - 24 V DC Connection M8	IP54 cULus	4000-75800-1715032
	<b>Modlight Illumix Slim Line C</b> 4 W - 24 V DC Connection M8 expandability	IP54 cULus	4000-75900-1715004
	8 W - 24 V DC Connection M8 expandability	IP54 cULus	4000-75900-1715008
	16 W - 24 V DC Connection M8 expandability	IP54 cULus	4000-75900-1715016
	24 W - 24 V DC Connection M8 expandability	IP54 cULus	4000-75900-1715024
	32 W - 24 V DC Connection M8 expandability	IP54 cULus	4000-75900-1715032
	<b>Modlight Illumix Classic Line</b> 6 W - 24 V DC Connection M12	IP67 cULus	4000-75801-1415006
	12 W - 24 V DC Connection M12	IP67 cULus	4000-75801-1415012
	18 W - 24 V DC Connection M12	IP67 cULus	4000-75801-1415018
	24 W - 24 V DC Connection M12	IP67 cULus	4000-75801-1415024

## LIGHTING ELEMENTS

LED machine lights			Art-No.
	<p><b>Modlight Illumix Classic Line C</b></p> <p>6 W - 24 V DC Connection M12 expandability</p> <p>12 W - 24 V DC Connection M12 expandability</p> <p>18 W - 24 V DC Connection M12 expandability</p> <p>24 W - 24 V DC Connection M12 expandability</p>	<p>IP67 cULus</p> <p>IP67 cULus</p> <p>IP67 cULus</p> <p>IP67 cULus</p>	<p><b>4000-75901-1415006</b></p> <p><b>4000-75901-1415012</b></p> <p><b>4000-75901-1415018</b></p> <p><b>4000-75901-1415024</b></p>
	<p><b>Modlight Illumix Xtreme</b></p> <p>27 W - 24 V DC Connection M12</p>	<p>IP69K cULus</p>	<p><b>4000-75827-1315000</b></p>
	<p><b>Modlight Illumix Xtreme</b></p> <p>Joint coupling</p>		<p><b>4000-75800-0000900</b></p>

Lighting Elements



# CONTROL DEVICES EMERGENCY STOP AND RESET PUSHBUTTONS

- Easy mounting
- Error-free connection
- Suitable for applications in the safety technology

## FAST AND ERROR-FREE WIRING WITH STANDARD CABLES

The **EMERGENCY STOP** and **RESET** buttons from Murrelektronik can be integrated very easily in electronic installations

These control and monitoring devices can be connected via preconfigured M12 cables (4-, 5-, or 8-pole). A time-saving solution excluding the risk of faulty wirings. The 'Plug & Play' feature makes integrating the control devices in machines and systems faster.

### 42 mm variants



#### E-Stop button

- With M12 connection
- 4-, 5-, or 8-pole variants

*Page 2.5.1*



#### R-Button

- With M12 connection
- 4- or 8-pole variants

*Page 2.5.1*

### 72 mm variants



#### E-Stop button

- With M12 connection
- 4-, 5-, or 8-pole variants
- With/without protective collar

*Page 2.5.1*

Control devices			Art-No.
	E-Stop 42 2NC M12(4) M12 (4-pole)	Emergency-Stop button 2 NC (positively-opening)	<b>69000</b>
	E-Stop 42 2NC M12(5) M12 (5-pole)	Emergency-Stop button 2 NC (positively-opening)	<b>69001</b>
	E-Stop 42 2NC L M12(8) M12 (8-pole)	Emergency-Stop button 2 NC (positively-opening) LED-Ring can be lit	<b>69002</b>
	E-Stop / R-B 42 2NC 1NO M12(8) M12 (8-pole)	Emergency-Stop button 2 NC (positively-opening) 1 button (1 NO contact) Flat lens, transparent clear, red, yellow, green, blue	<b>69003</b>
	E-Stop / R-B 42 2NC 1NO L M12(8) M12 (8-pole)	Emergency-Stop button 2 NC (positively-opening) 1 button can be lit (1 NO contact) Flat lens, transparent clear, red, yellow, green, blue	<b>69004</b>
	R-Button / 42 1NO M12(4) M12 (4-pole)	1 button (1 NO contact) Flat lens, transparent clear, red, yellow, green, blue	<b>69010</b>
	R-Button / 42 1NO L M12(4) M12 (4-pole)	1 button can be lit (1 NO contact) Flat lens, transparent clear, red, yellow, green, blue	<b>69013</b>
	R-Button / 42 2NO M12(4) M12 (4-pole)	2 buttons (each 1 NO contact) Flat lens, transparent clear, red, yellow, green, blue	<b>69011</b>
	R-Button / 42 2NO L M12(8) M12 (8-pole)	2 buttons can be lit (each 1 NO contact) Flat lens, transparent clear, red, yellow, green, blue	<b>69012</b>
	E-Stop 72 2NC M12(4) M12 (4-pole)	Emergency-Stop button 2 NC (positively-opening)	<b>55550</b>
	E-Stop 72 2NC M12(5) M12 (5-pole)	Emergency-Stop button 2 NC (positively-opening)	<b>69041</b>
	E-Stop 72 2NC L M12(8) M12 (8-pole)	Emergency-Stop button 2 NC (positively-opening) LED-Ring can be lit	<b>69043</b>
	E-Stop 72P 2NC M12(4) M12 (4-pole)	Emergency-Stop button 2 NC (positively-opening) with protection shroud	<b>69040</b>
	E-Stop 72P 2NC M12(5) M12 (5-pole)	Emergency-Stop button 2 NC (positively-opening) with protection shroud	<b>69042</b>

## CONTROL DEVICES

Accessories control devices			Art-No.
	<b>T-coupler (SlimLine) M12 - M12</b> Male straight - female/male straight	for 8-pole Emergency-Stop button	<b>7030-42622-0000000</b>

Control devices



# MODLINK VARIO MEDIA CONNECTOR

- Easy mounting and dismounting without the need of tools
- Maximum robustness, all components being made of solid metal
- Electronics and media in one coupling

## MAXIMUM MODULARITY IN INDUSTRIAL ENVIRONMENT

**Modlink Vario is a modular media connector to couple and decouple pneumatics, fluids and electronics with just one system.**

It is suitable for uncomplicated use on switch cabinets, tools and machine parts. Its unique feature is that it allows simultaneous non-drip coupling under pressure of electrical connections and media. The basic modules are available in 4, 6, 8 or 10 different models.

For each bore, the type of application, pneumatics, fluids or electronics, can be freely selected. This gives almost unlimited equipment options.

### Base body



#### Round or rectangular

- Different locking types (union nut, lever)
- Connections made of aluminum or stainless steel
- Different types (e.g. 4, 6, 8, and 10 connections)

*Page 2.6.1*

*An overview of this product range can be found in our online shop*

### Inserts

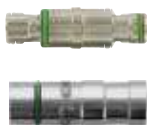

#### Inserts

- Inserts for power and media supply
- Inserts for the connection of different M12 connecting cables
- Pneumatics and fluid inserts for a variety of hose diameters





*Page 2.6.2*

# MODULAR CONNECTION SYSTEMS (MODLINK VARIO)

Stationary housing (round)			Art-No.
	4-way	Aluminium	<b>M1850-040601</b>
		Stainless Steel 1.4404 (V4A)	<b>M1851-040601</b>
	6-way	Aluminium	<b>M1850-060601</b>
		Stainless Steel 1.4404 (V4A)	<b>M1851-060601</b>
	8-way	Aluminium	<b>M1850-080601</b>
		Stainless Steel 1.4404 (V4A)	<b>M1851-080601</b>
	10-way	Aluminium	<b>M1850-100601</b>
		Stainless Steel 1.4404 (V4A)	<b>M1851-100601</b>
Mobile housing (round)			Art-No.
	4-way	Aluminium	<b>M1850-040602</b>
		Stainless Steel 1.4404 (V4A)	<b>M1851-040602</b>
	6-way	Aluminium	<b>M1850-060602</b>
		Stainless Steel 1.4404 (V4A)	<b>M1851-060602</b>
	8-way	Aluminium	<b>M1850-080602</b>
		Stainless Steel 1.4404 (V4A)	<b>M1851-080602</b>



## MODULAR CONNECTION SYSTEMS (MODLINK VARIO)

Mobile housing (round)			Art-No.
	10-way	Aluminium	M1850-100602
		Stainless Steel 1.4404 (V4A)	M1851-100602
Stationary housing (rectangular)			Art-No.
	8-way	Aluminium	M1856-24080611
Mobile housing (rectangular)			Art-No.
	8-way	Aluminium	M1856-24080612
Inserts Media (Stationary housing)			Art-No.
	AD4 without shut-off	Brass, nickel plated	MVT1821-062406021
	AD6 without shut-off	Brass, nickel plated	MVT1821-062406041
	AD8 without shut-off	Brass, nickel plated	MVT1821-062406061
	AD4 with shut-off	Brass, nickel plated	MVT1820-062406021
	AD6 with shut-off	Brass, nickel plated	MVT1820-062406041
	AD8 with shut-off	Brass, nickel plated	MVT1820-062406061
	AD6 drip-free	Brass, dezincification-resistant	MVT1825-262406041
	AD8 drip-free	Brass, dezincification-resistant	MVT1825-262406061

# MODULAR CONNECTION SYSTEMS (MODLINK VARIO)

Inserts Media (Mobile housing)			Art-No.
	AD4 without shut-off	Brass, nickel plated	MVT1821-062406022
	AD6 without shut-off	Brass, nickel plated	MVT1821-062406042
	AD8 without shut-off	Brass, nickel plated	MVT1821-062406062
	AD4 with shut-off	Brass, nickel plated	MVT1820-062406022
	AD6 with shut-off	Brass, nickel plated	MVT1820-062406042
	AD8 with shut-off	Brass, nickel plated	MVT1820-062406062
	AD6 drip-free	Brass, dezincification-resistant	MVT1825-262406042
	AD8 drip-free	Brass, dezincification-resistant	MVT1825-262406062
	Inserts Electro (Stationary housing)		
	M12, 5-pole	A-coded	7000-42114-0000000
	M12, 4-pole	B-coded	7000-44114-0000000
	M12, 6-pole	A-coded	7000-46114-0000000
	M12, 8-pole	A-coded	7000-48114-0000000
	M12, 4-pole	D-coded	7000-44624-0000000
Inserts Electro (Mobile housing)			Art-No.
	M12, 5-pole	A-coded	7000-42116-0000000
	M12, 4-pole	B-coded	7000-44116-0000000
	M12, 6-pole	A-coded	7000-46116-0000000
	M12, 4-pole	A-coded	7000-48116-0000000
	M12, 4-pole	D-coded	7000-44586-0000000



# MODLINK HEAVY HEAVY DUTY CONNECTOR

- Maximum variety
- High tightness
- Worldwide use

## MAXIMUM MODULARITY IN INDUSTRIAL ENVIRONMENT

The heavy-duty plug connectors of the Modlink Heavy series from Murrelektronik guarantee secure transmission of signals, energy, data and pneumatics - even in the roughest of industrial environments. They consistently protect interfaces from water, dirt and high mechanical loads.

We provide a broad range of products. For our customers, we offer a matching connector for every requirement - Flexibility in the configuration of the plug connectors is our great strength. Thus, for housings, we offer as many as four different types, each in seven different sizes. They can be locked, as needed, by three different methods. As for contact inserts, you can choose from a large number of fixed-pole or modular versions. Our offer of accessories is exactly tuned to the heavy-duty plug connectors from Murrelektronik and rounded off to the last detail.

### Housings



- 4 housing types
- 7 different sizes
- 3 locking types
- Outgoing cables in all directions

Page 2.7.1

*An overview of this product range can be found in our online shop*

### Inserts



- Series A, D, E, EE, K, HSE, HV and Q
- 3 different connection types

Page 2.7.3

*An overview of this product range can be found in our online shop*

### Frames and modules



- 4 frame sizes
- Modules for signals, energy, data and pneumatics







Page 2.7.5

*An overview of this product range can be found in our online shop*

# HEAVY DUTY CONNECTORS (MODLINK HEAVY)

Hood			Art-No.
	<b>B6</b> Form Looking techniques Cable outlet Threaded hole	low Single locking lever straight M20	70MH-GTDNL-A01B000
	<b>B6</b> Form Looking techniques Cable outlet Threaded hole	low Single locking lever laterally M20	70MH-GTDNL-A02B000
	<b>B10</b> Form Looking techniques Cable outlet Threaded hole	low Double locking lever straight M25	70MH-GTENQ-A01C000
	<b>B10</b> Form Looking techniques Cable outlet Threaded hole	low Double locking lever laterally M25	70MH-GTENQ-A02C000
	<b>B16</b> Form Looking techniques Cable outlet Threaded hole	high Double locking lever straight M32	70MH-GTFHQ-A01D000
	<b>B16</b> Form Looking techniques Cable outlet Threaded hole	high Double locking lever laterally M32	70MH-GTFHQ-A02D000
	<b>B24</b> Form Looking techniques Cable outlet Threaded hole	high Double locking lever straight M32	70MH-GTGHQ-A01D000

## HEAVY DUTY CONNECTORS (MODLINK HEAVY)

Hood			Art-No.
	<b>B24</b> Form Locking techniques Cable outlet Threaded hole	high Double locking lever laterally M32	<b>70MH-GTGHQ-A02D000</b>
Bulkhead mounted housing			Art-No.
	<b>B6</b> Locking techniques Protection	Single locking lever IP65	<b>70MH-GADNL-B000000</b>
	<b>B10</b> Locking techniques Protection	Double locking lever IP65	<b>70MH-GAENQ-B000000</b>
	<b>B16</b> Locking techniques Protection	Double locking lever IP65	<b>70MH-GAFNQ-B000000</b>
	<b>B24</b> Locking techniques Protection	Double locking lever IP65	<b>70MH-GAGNQ-B000000</b>
Surface mounted housing			Art-No.
	<b>B6</b> Form Locking techniques Cable outlet Threaded hole	low Single locking lever laterally M20	<b>70MH-GSDNL-B01B000</b>
	Form Locking techniques Cable outlet Threaded hole	low Single locking lever double-sided M20	<b>70MH-GSDNL-B02B000</b>
	<b>B10</b> Form Locking techniques Cable outlet Threaded hole	low Double locking lever laterally M25	<b>70MH-GSEHQ-B01C000</b>
	Form Locking techniques Cable outlet Threaded hole	high Double locking lever double-sided M25	<b>70MH-GSEHQ-B02C000</b>









# HEAVY DUTY CONNECTORS (MODLINK HEAVY)

Surface mounted housing			Art-No.
	<b>B16</b> Form Locking techniques Cable outlet Threaded hole	high Double locking lever laterally M32	70MH-GSFHQ-B01D000
	Form Locking techniques Cable outlet Threaded hole	high Double locking lever double-sided M32	70MH-GSFHQ-B02D000
	<b>B24</b> Form Locking techniques Cable outlet Threaded hole	high Double locking lever laterally M32	70MH-GSGHQ-B01D000
	Form Locking techniques Cable outlet Threaded hole	high Double locking lever double-sided M32	70MH-GSGHQ-B02D000
Coupling housing			Art-No.
	<b>B10</b> Form Locking techniques Cable outlet Threaded hole	low Double locking lever straight M25	70MH-GKENQ-B01C000
	<b>B16</b> Form Locking techniques Cable outlet Threaded hole	high Double locking lever straight M32	70MH-GKFHQ-B01D000
	<b>B24</b> Form Locking techniques Cable outlet Threaded hole	high Double locking lever straight M32	70MH-GKGHQ-B01D000
Fixed-pole inserts			Art-No.
	<b>B6</b> Type No. of poles Connection E-Series	Male 6 Push-In terminals	70MH-ES006-DP03020

## HEAVY DUTY CONNECTORS (MODLINK HEAVY)

Fixed-pole inserts			Art-No.
	<b>B10</b> Type No. of poles Connection E-Series	Male 10 Push-In terminals	<b>70MH-ES010-EP03020</b>
	<b>B16</b> Type No. of poles Connection E-Series	Male 16 Push-In terminals	<b>70MH-ES016-FP03020</b>
	<b>B24</b> Type No. of poles Connection E-Series	Male 24 Push-In terminals	<b>70MH-ES024-GP03020</b>
	<b>B6</b> Type No. of poles Connection E-Series	Female 6 Push-In terminals	<b>70MH-EB006-DP03020</b>
	<b>B10</b> Type No. of poles Connection E-Series	Female 10 Push-In terminals	<b>70MH-EB010-EP03020</b>
	<b>B16</b> Type No. of poles Connection E-Series	Female 16 Push-In terminals	<b>70MH-EB016-FP03020</b>
	<b>B24</b> Type No. of poles Connection E-Series	Female 24 Push-In terminals	<b>70MH-EB024-GP03020</b>

# HEAVY DUTY CONNECTORS (MODLINK HEAVY)

Frame			Art-No.
	<b>Male</b> B6	for 2 modules	70MH-RD02S-0000000
	<b>Male</b> B10	for 3 modules	70MH-RE03S-0000000
	<b>Male</b> B16	for 4 modules	70MH-RF04S-0000000
	<b>Male</b> B24	for 6 modules	70MH-RG06S-0000000
	<b>Female</b> B6	for 2 modules	70MH-RD02B-0000000
	<b>Female</b> B10	for 3 modules	70MH-RE03B-0000000
	<b>Female</b> B16	for 4 modules	70MH-RF04B-0000000
	<b>Female</b> B24	for 6 modules	70MH-RG06B-0000000
Blind module			Art-No.
	<b>Male/female</b>		70MH-MAA10-0000000



## HEAVY DUTY CONNECTORS (MODLINK HEAVY)

Module 1-pole (axial screw connection)			Art-No.
	<b>Male</b>		
	Operating voltage	1 000 V AC/DC	<b>70MH-MAB2A-0010707</b>
	Operating current	200 A	
No. of poles	1		
	<b>Female</b>		
	Operating voltage	1 000 V AC/DC	<b>70MH-MAC2A-0010707</b>
	Operating current	200 A	
No. of poles	1		
PE modules 1-pole (axial screw connection)			Art-No.
	<b>Male</b>		
	Operating current	200 A	<b>70MH-MAQ2A-0010707</b>
	No. of poles	1 (PE)	
	<b>Female</b>		
	Operating current	200 A	<b>70MH-MAR2A-0010707</b>
	No. of poles	1 (PE)	
Module 2-pole (axial screw connection)			Art-No.
	<b>Male</b>		
	Operating voltage	1 000 V AC/DC	<b>70MH-MAB1A-0020703</b>
	Operating current	40 A	
	No. of poles	2	
	Operating voltage	1 000 V AC/DC	<b>70MH-MAB1A-0020706</b>
	Operating current	70 A	
	No. of poles	2	
	Operating voltage	1 000 V AC/DC	<b>70MH-MAB2A-0020704</b>
	Operating current	100 A	
No. of poles	2		
	<b>Female</b>		
	Operating voltage	1 000 V AC/DC	<b>70MH-MAC1A-0020703</b>
	Operating current	40 A	
	No. of poles	2	
	Operating voltage	1 000 V AC/DC	<b>70MH-MAC1A-0020706</b>
	Operating current	70 A	
	No. of poles	2	
	Operating voltage	1 000 V AC/DC	<b>70MH-MAC2A-0020704</b>
	Operating current	100 A	
No. of poles	2		

# HEAVY DUTY CONNECTORS (MODLINK HEAVY)

Modules 2-pole (Crimp)			Art-No.
	<b>Male</b> Operating voltage Operating current No. of poles	1000 V AC/DC 100 A 2	70MH-MAF2C-0020704
	<b>Female</b> Operating voltage Operating current No. of poles	1000 V AC/DC 100 A 2	70MH-MAG2C-0020704
Modules 2-pole shielded (Crimp)			Art-No.
	<b>Male</b> No. of poles for coax- and 4-pole contact carrier	2	70MH-MAD2C-0020101
	<b>Female</b> No. of poles for coax- and 4-pole contact carrier	2	70MH-MAE2C-0020101
Modules 3 pole (crimp)			Art-No.
	<b>Male</b> Operating voltage Operating current No. of poles	690 V AC/DC (PIN - PIN); 400 V AC/DC (PIN - PE) 40 A 3	70MH-MAB1C-0030903
	<b>Female</b> Operating voltage Operating current No. of poles	690 V AC/DC (PIN - PIN); 400 V AC/DC (PIN - PE) 40 A 3	70MH-MAC1C-0030903
Modules 4 pole (crimp)			Art-No.
	<b>Male</b> Operating voltage Operating current No. of poles	830 V AC/DC 40 A 4	70MH-MAB1C-0040603

## HEAVY DUTY CONNECTORS (MODLINK HEAVY)

Modules 4 pole (crimp)			Art-No.
	<b>Female</b> Operating voltage Operating current No. of poles	830 V AC/DC 40 A 4	70MH-MAC1C-0040603
Modules 5 pole (push-in)			Art-No.
	<b>Male</b> Operating voltage Operating current No. of poles	400 V AC/DC 16 A 5	70MH-MAB1P-0050402
	<b>Female</b> Operating voltage Operating current No. of poles	400 V AC/DC 16 A 5	70MH-MAC1P-0050402
Modules 6 pole (crimp)			Art-No.
	<b>Male</b> Operating voltage Operating current No. of poles	500 V AC/DC 16 A 6	70MH-MAB1C-0060502
	<b>Female</b> Operating voltage Operating current No. of poles	500 V AC/DC 16 A 6	70MH-MAC1C-0060502
Modules 8-pole (Crimp)			Art-No.
	<b>Male</b> Operating voltage Operating current No. of poles	400 V AC/DC 16 A 8	70MH-MAB1C-0080402
	<b>Female</b> Operating voltage Operating current No. of poles	400 V AC/DC 16 A 8	70MH-MAC1C-0080402

# HEAVY DUTY CONNECTORS (MODLINK HEAVY)

Modules 12 pole (crimp)			Art-No.
	<b>Male</b> Operating voltage Operating current No. of poles	400 V AC/DC (PIN - PIN); 250 V AC/DC (PIN - PE) 10 A 12	<b>70MH-MAB1C-0120801</b>
	<b>Female</b> Operating voltage Operating current No. of poles	400 V AC/DC (PIN - PIN); 250 V AC/DC (PIN - PE) 10 A 12	<b>70MH-MAC1C-0120801</b>
Modules 17-pole (Crimp)			Art-No.
	<b>Male</b> Operating voltage Operating current No. of poles	160 V AC/DC 10 A 17	<b>70MH-MAB1C-0170201</b>
	<b>Female</b> Operating voltage Operating current No. of poles	160 V AC/DC 10 A 17	<b>70MH-MAC1C-0170201</b>
Modules 20-pole (Crimp)			Art-No.
	<b>Male</b> Operating voltage Operating current No. of poles	500 V AC/DC 16 A 20	<b>70MH-MAB1C-0200502</b>
	<b>Female</b> Operating voltage Operating current No. of poles	500 V AC/DC 16 A 20	<b>70MH-MAC1C-0200502</b>
Modules GIGABIT			Art-No.
	<b>Male</b> Transfer parameters	CAT6A	<b>70MH-MAH1C-0000000</b>

# HEAVY DUTY CONNECTORS (MODLINK HEAVY)

Modules GIGABIT			Art-No.
	<b>Female</b>		
	Transfer parameters	CAT6A	70MH-MAL1C-0000000
Modules RJ45			Art-No.
	<b>Male</b>		
	Transfer parameters	CAT6A (IEC 60512-27-100:2008, TIA-568-C.2:2009)	70MH-MAL10-0000000
	<b>Male</b>		
	Transfer parameters	CAT5e	70MH-MAL10-0010000
	<b>Male</b>		
	Insert Transfer parameters	for 70MH-MAL10-0010000 CAT5	70MH-ZRJ45-1000000
	<b>Male</b>		
	Insert Transfer parameters	for 70MH-MAL10-0010000 CAT5	70MH-ZRJ45-2000000
	<b>Female</b>		
	Transfer parameters	CAT6A (IEC 60512-27-100:2008, TIA-568-C.2:2009)	70MH-MAM10-0000000
Modules pneumatic			Art-No.
	<b>Male/female</b>		
	2-pole	Internal hose Ø 6 mm	70MH-MAP10-0020000
	3-pole	Internal hose Ø 1.6, 3, 4 mm	70MH-MAP10-0030000



3

## CONNECTION TECHNOLOGY

**3**

**CONNECTION  
TECHNOLOGY**

M8 Round Plug Connectors	<b>3.1</b>
M12 Round Plug Connectors	<b>3.2</b>
T-couplers M8, M12, 7/8"	<b>3.3</b>
Flange Connectors	<b>3.4</b>
MQ12 Round Plug Connectors	<b>3.5</b>
Fieldbus Connectors	<b>3.6</b>
Plug Connectors for Food & Beverage	<b>3.7</b>
Mobile Applications	<b>3.8</b>
M23 Round Plug Connectors	<b>3.9</b>
Round Plug Connectors Power	<b>3.10</b>
TPE Series – The North American standard	<b>3.11</b>
Valve Connectors	<b>3.12</b>
Technical Appendix Cables	<b>3.13</b>



# MURRELEKTRONIK'S CONNECTORS

## ORDERING SYSTEM

Our concept for your individual application solutions.

Our connector range is a modular system that you can customize for your application.

## ARTICLE NUMBER SYSTEM

The article number consists of three blocks: form, jacket material/color and cable length.

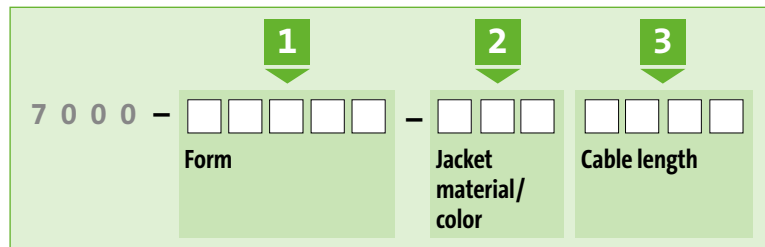

## EXAMPLE

<b>Block 1:</b> Form	<b>1 2 4 0 1</b>	M12 female 90° with LED, 4-pole
<b>Block 2:</b> Jacket material/color	<b>0 3 3</b>	PUR (UL/CSA), yellow
<b>Block 3:</b> Cable length	<b>0 3 0 0</b>	3 m

The resulting part number is how you will order your connector.

7 0 0 0 - **1 2 4 0 1** - **0 3 3** **0 3 0 0**



## INTERNATIONAL APPROVALS FOR FLEXIBLE USE WORLDWIDE



### DID YOU KNOW?

Every Murrelektronik connector is 100% tested.

#### This means:

- Electrically tested
- High voltage tested
- Performance tested
- Pin assignment tested
- Short circuit tested
- Visually controlled

## YOUR BENEFITS

- **Modular connector program**
  - Find your connector quickly
- **International approvals**
  - Products approved for your market
- **Guaranteed quality**
  - 100% tested
  - All contacts gold-plated
  - High IP67 protection as standard
  - Shock and vibration resistant
- **Worldwide and industry wide**
  - Benefit from our expertise and our cross-industry expertise



## AUDIBLY SEALED – SIMPLE AND SAFE

Our torque wrench connects Murrelektronik M8-, M12-, 7/8" and M23 connectors simply and tightly, leaving no room for error.

click  
click  
click

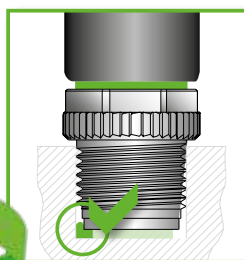

M8	0.4 Nm
M12	0.6 Nm
7/8"	1.5 Nm
M23	2.0 Nm

Just turn until you hear the click.

No more sore fingers!

# STANDARD CABLE TYPES FOR YOUR APPLICATION



## WIDE RANGE MEETS YOUR REQUIREMENTS

- **4 standard cable types for your application solution**
  - Always the right cable
- **3 cable colors (yellow, gray and black)**
  - The color you need for your industry
- **Meets the highest quality requirements**
  - Certified, application approved and successfully tested with many aggressive media (oil and lubricants)



Cable Types		PVC	PUR/PVC	PUR	PUR Welding Spark Resistant
Cable Standard		★	★★	★★★	★★★★★
Properties*	Flame retardant	■	■	■	■
	Resistant to chemicals	■	■	■	■
	Resistant to cleaning agents (Ecolab)	■			
	Resistant to oil and lubricants		■	■	■
	Suitable for use in Ctracks**		2 million	5 million	10 million
	Suitable for robotic applications			±180°	±360°
	Welding spark resistant				■
	UV resistant			■	■
	Halogen-free			■	■
	Varying temperatures	-5...+80 °C	-5...+80 °C	-25...+80 °C	-25...+90 °C
	UL/CSA approvals	■		■	■
	Compliant with NFPA 79 Edition 2012	■		■	
Application Examples		Packaging machines Food & Beverage Assembly lines Production lines	Packaging machines Handling machines Assembly lines Production lines	Machine tools Swivel tables Metal cutting	Machine tools Industrial robots Metal cutting High performance Ctracks

\* The properties of some cable types may differ from this data.

\*\* Max. 3.3 m/s at 5 m horizontal travel distance and max. acceleration of 5 m/s².



# M8 ROUND PLUG CONNECTORS

## SMALL, LIGHT, MEETS YOUR NEEDS

- Extensive selection
- Tested technology
- Modern design

### M8 REDESIGN – MORE MODELS, & NEW DESIGN

**M8's redesign introduces new innovations.** We completely redesigned all Murrelektronik's molded M8 connectors. They now have a new look and have been upgraded. We also significantly expanded our range of shielded M8 connectors.



**Features:**

- Durable PUR molding
- Gold plated contacts
- Small dimensions and improved feel
- Corrugated tubing connection
- Hex screw with thread (SW9)





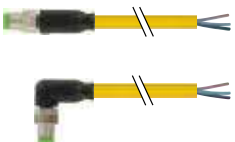
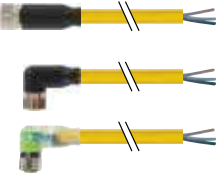

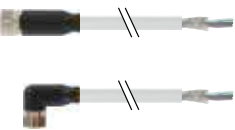
**Huge Variety:**

- Male/female, straight/90°, 3-pole/4-pole
- Shielded and unshielded connectors
- 3 standard colors, 4 standard cable types
- Cables, open ended wires, T-couplers, adapters, models with LED

### With Open Ended Wires

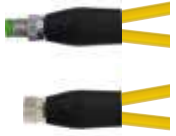
 <p><b>M8 male</b></p> <ul style="list-style-type: none"> <li>• Straight</li> <li>• 90°</li> </ul> <p style="text-align: right;"><i>Page 3.1.1</i></p>	 <p><b>M8 female</b></p> <ul style="list-style-type: none"> <li>• Straight</li> <li>• 90°</li> <li>• 90° with LED</li> </ul> <p style="text-align: right;"><i>Page 3.1.3</i></p>
 <p><b>M8 male (shielded)</b></p> <ul style="list-style-type: none"> <li>• Straight</li> <li>• 90°</li> </ul> <p style="text-align: right;"><i>Page 3.1.6</i></p>	 <p><b>M8 female (shielded)</b></p> <ul style="list-style-type: none"> <li>• Straight</li> <li>• 90°</li> </ul> <p style="text-align: right;"><i>Page 3.1.8</i></p>

## Connection Cables

		<p><b>M8 male</b> • Straight</p>	<p><b>M8 female</b> • Straight • 90° • 90° with LED</p>
		<p><b>Y connector M8</b> • Male straight</p> <p><b>Y connector M8</b> • Female straight</p>	<p><b>M8 female</b> • Straight</p> <p><b>M8 male</b> • Straight</p>
		<p><b>M8 male (shielded)</b> • Straight</p>	<p><b>M8 female (shielded)</b> • Straight • 90°</p>

## Field-Wireable

	<p><b>Insulation Displacement Technology (IDC)</b> 0.14...0.34 mm<sup>2</sup></p>	<p><b>M8 male/female</b> • Straight</p>	<p>Page 3.1.17</p>
	<p><b>Screw terminals</b></p>	<p><b>M8 male/female</b> • Straight</p>	<p>Page 3.1.18</p>
	<p><b>Screw terminals (shielded)</b></p>	<p><b>M8 male/female</b> • Straight</p>	<p>Page 3.1.19</p>

# M8 ROUND PLUG CONNECTORS

With open ended wires

Male

straight



\* only for products with UL/CSA approved cable

1 Form	08001	me	08011	me		
Type	3-pole		4-pole			
Circuit diagram						
Contact layout						
2 Cable Type	Jacket Color			Jacket Color		
Wire diameter 0.25 mm <sup>2</sup>	yellow	gray	black	yellow	gray	black
PVC (UL/CSA)	010	210	610	011	211	611
PUR/PVC (UL/CSA)	020	220	620	021	221	621
PUR (UL/CSA), robots/C-tracks	030	230	630	031	231	631
PUR (UL/CSA), welding spark	050	250	650	051	251	651
3 Cable Length						
1.5 m	0150					
3.0 m	0300					
5.0 m	0500					
7.5 m	0750					
10.0 m	1000					
Technical Data						
Operating voltage	max. 50 V AC/60 V DC					
Protection	IP65, IP66K, IP67 inserted and tightened (EN 60529)					
Temperature range	-25...+85 °C, depending on cable quality					
Article No.						
The composition of your article number is explained on page 3.1.i	7 0 0 0		-		-	
	7 0 0 5		M8 Lite (plastic hexagonal screw) on request			
	1 Form		2 Cable Type		3 Cable Length	
Notes	Other versions on request. Differing cable lengths up to 2 m can be ordered in 0.2 m steps, from 2 m on in 0.5 m steps.					

# M8 ROUND PLUG CONNECTORS

With open ended wires

Male

90°

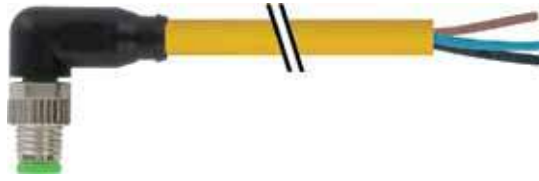

\* only for products with UL/CSA approved cable

M8 Round Plug Connectors

1 Form	08021	meX	08031	meX		
Type	3-pole		4-pole			
Circuit diagram						
Contact layout						
2 Cable Type	Jacket Color			Jacket Color		
Wire diameter 0.25 mm <sup>2</sup>	yellow	gray	black	yellow	gray	black
PVC (UL/CSA)	010	210	610	011	211	611
PUR/PVC (UL/CSA)	020	220	620	021	221	621
PUR (UL/CSA), robots/C-tracks	030	230	630	031	231	631
PUR (UL/CSA), welding spark	050	250	650	051	251	651
3 Cable Length						
1.5 m	0150					
3.0 m	0300					
5.0 m	0500					
7.5 m	0750					
10.0 m	1000					
Technical Data						
Operating voltage	max. 50 V AC/60 V DC					
Protection	IP65, IP66K, IP67 inserted and tightened (EN 60529)					
Temperature range	-25...+85 °C, depending on cable quality					
Article No.						
The composition of your article number is explained on page 3.1.i	7 0 0 0		-		-	
	7 0 0 5		M8 Lite (plastic hexagonal screw) on request			
	1 Form		2 Cable Type		3 Cable Length	
Notes	Other versions on request. Differing cable lengths up to 2 m can be ordered in 0.2 m steps, from 2 m on in 0.5 m steps.					

# M8 ROUND PLUG CONNECTORS

With open ended wires

Female  
straight



\* only for products with UL/CSA approved cable

M8 Round Plug Connectors

1 Form	08041	me	08061	me		
Type	3-pole		4-pole			
Circuit diagram						
Contact layout						
2 Cable Type	Jacket Color			Jacket Color		
Wire diameter 0.25 mm <sup>2</sup>	yellow	gray	black	yellow	gray	black
PVC (UL/CSA)	010	210	610	011	211	611
PUR/PVC (UL/CSA)	020	220	620	021	221	621
PUR (UL/CSA), robots/C-tracks	030	230	630	031	231	631
PUR (UL/CSA), welding spark	050	250	650	051	251	651
3 Cable Length						
1.5 m	0150					
3.0 m	0300					
5.0 m	0500					
7.5 m	0750					
10.0 m	1000					
Technical Data						
Operating voltage	max. 50 V AC/60 V DC					
Protection	IP65, IP66K, IP67 inserted and tightened (EN 60529)					
Temperature range	-25...+85 °C, depending on cable quality					
Article No.						
The composition of your article number is explained on page 3.1.i	7 0 0 0		-		-	
	7 0 0 5		M8 Lite (plastic hexagonal screw) on request			
	1 Form		2 Cable Type		3 Cable Length	
Notes	Other versions on request. Differing cable lengths up to 2 m can be ordered in 0.2 m steps, from 2 m on in 0.5 m steps.					

# M8 ROUND PLUG CONNECTORS

With open ended wires

Female  
90°



\* only for products with UL/CSA approved cable

M8 Round Plug Connectors

1 Form	08081	meX	08101	meX					
Type	3-pole		4-pole						
Circuit diagram									
Contact layout									
2 Cable Type	Jacket Color			Jacket Color					
Wire diameter 0.25 mm <sup>2</sup>	yellow	gray	black	yellow	gray	black			
PVC (UL/CSA)	010	210	610	011	211	611			
PUR/PVC (UL/CSA)	020	220	620	021	221	621			
PUR (UL/CSA), robots/C-tracks	030	230	630	031	231	631			
PUR (UL/CSA), welding spark	050	250	650	051	251	651			
3 Cable Length									
1.5 m	0150								
3.0 m	0300								
5.0 m	0500								
7.5 m	0750								
10.0 m	1000								
Technical Data									
Operating voltage	max. 50 V AC/60 V DC								
Protection	IP65, IP66K, IP67 inserted and tightened (EN 60529)								
Temperature range	-25...+85 °C, depending on cable quality								
Article No.									
The composition of your article number is explained on page 3.1.i	7 0 0 0			-		-		-	
	7 0 0 5			M8 Lite (plastic hexagonal screw) on request					
	1 Form		2 Cable Type		3 Cable Length				
Notes	Other versions on request. Differing cable lengths up to 2 m can be ordered in 0.2 m steps, from 2 m on in 0.5 m steps.								



# M8 ROUND PLUG CONNECTORS

With open ended wires

**Female**  
90° with LED

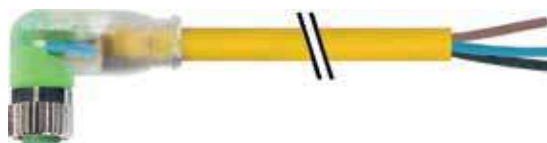

\* only for products with UL/CSA approved cable

1 Form	08121	me	08141
Type	3-pole with 2 × LED (PNP) (NPN) on request		4-pole with 3 × LED (PNP) (NPN) on request
Circuit diagram			
Contact layout	<p>Female</p>		<p>Female</p>
2 Cable Type	<b>Jacket Color</b>		<b>Jacket Color</b>
Wire diameter 0.25 mm <sup>2</sup>	<b>yellow</b>	gray	black
PVC (UL/CSA)	<b>010</b>	210	610
PUR/PVC (UL/CSA)	<b>020</b>	220	620
PUR (UL/CSA), robots/C-tracks	<b>030</b>	230	630
PUR (UL/CSA), welding spark	<b>050</b>	250	650
3 Cable Length			
1.5 m	<b>0150</b>		
3.0 m	<b>0300</b>		
5.0 m	<b>0500</b>		
7.5 m	<b>0750</b>		
10.0 m	<b>1000</b>		
Technical Data			
Operating voltage	24 V DC ±25%		
Protection	IP65, IP66K, IP67 inserted and tightened (EN 60529)		
Temperature range	-25...+85 °C, depending on cable quality		
Article No.			
The composition of your article number is explained on page 3.1.i	<b>7 0 0 0</b>	-	-
	<b>7 0 0 5</b>		M8 Lite (plastic hexagonal screw) on request
	<b>1</b>	<b>Form</b>	<b>2</b> <b>Cable Type</b>
	<b>3</b>	<b>Cable Length</b>	
Notes	Other versions on request. Differing cable lengths up to 2 m can be ordered in 0.2 m steps, from 2 m on in 0.5 m steps.		

# M8 ROUND PLUG CONNECTORS

With open ended wires

Male  
straight



\* only for products with UL/CSA approved cable

1 Form		08701	08711												
Type		3-pole, shielded	4-pole, shielded												
Circuit diagram															
Contact layout		<p>Male</p>	<p>Male</p>												
2 Cable Type	Jacket Color	<table border="1"> <thead> <tr> <th>Jacket Color</th> <th>gray</th> <th>black</th> </tr> </thead> <tbody> <tr> <td>Wire diameter 0.34 mm<sup>2</sup></td> <td></td> <td></td> </tr> <tr> <td>PVC (UL/CSA)</td> <td>200</td> <td>600</td> </tr> <tr> <td>PUR (UL/CSA), robots/C/tracks</td> <td>240</td> <td>640</td> </tr> </tbody> </table>		Jacket Color	gray	black	Wire diameter 0.34 mm <sup>2</sup>			PVC (UL/CSA)	200	600	PUR (UL/CSA), robots/C/tracks	240	640
	Jacket Color	gray	black												
	Wire diameter 0.34 mm <sup>2</sup>														
PVC (UL/CSA)	200	600													
PUR (UL/CSA), robots/C/tracks	240	640													
3 Cable Length	1.5 m	0150													
	3.0 m	0300													
	5.0 m	0500													
	7.5 m	0750													
	10.0 m	1000													
<b>Technical Data</b>															
Operating voltage	max. 50 V AC/60 V DC														
Protection	IP65, IP66K, IP67 inserted and tightened (EN 60529)														
Temperature range	-25...+85 °C, depending on cable quality														
<b>Article No.</b>															
The composition of your article number is explained on page 3.1.i	<table border="1"> <tr> <td><u>7</u></td> <td><u>0</u></td> <td><u>0</u></td> <td><u>0</u></td> <td>-</td> <td>---</td> <td>-</td> <td>---</td> <td>---</td> </tr> </table>			<u>7</u>	<u>0</u>	<u>0</u>	<u>0</u>	-	---	-	---	---			
<u>7</u>	<u>0</u>	<u>0</u>	<u>0</u>	-	---	-	---	---							
	<b>1</b>	Form	<b>2</b>	Cable Type	<b>3</b>	Cable Length									
<b>Notes</b>				Other versions on request. Differing cable lengths up to 2 m can be ordered in 0.2 m steps, from 2 m on in 0.5 m steps.											

M8 Round Plug Connectors

# M8 ROUND PLUG CONNECTORS

With open ended wires

Male

90°



\* only for products with UL/CSA approved cable

1 Form		08721	08731
Type		3-pole, shielded	4-pole, shielded
Circuit diagram			
Contact layout		<p>Male</p>	<p>Male</p>
2 Cable Type	Jacket Color	Jacket Color	
Wire diameter 0.34 mm <sup>2</sup>		gray	black
PVC (UL/CSA)		200	600
PUR (UL/CSA), robots/Ctracks		240	640
3 Cable Length			
1.5 m		0150	
3.0 m		0300	
5.0 m		0500	
7.5 m		0750	
10.0 m		1000	
Technical Data			
Operating voltage		max. 50 V AC/60 V DC	
Protection		IP65, IP66K, IP67 inserted and tightened (EN 60529)	
Temperature range		-25...+85 °C, depending on cable quality	
Article No.			
The composition of your article number is explained on page 3.1.i		7 0 0 0	- - - - -
		1 Form	2 Cable Type 3 Cable Length
Notes		Other versions on request. Differing cable lengths up to 2 m can be ordered in 0.2 m steps, from 2 m on in 0.5 m steps.	

# M8 ROUND PLUG CONNECTORS



With open ended wires

Female  
straight

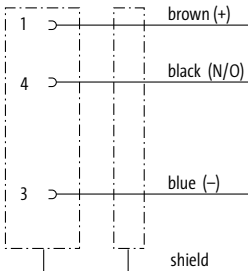
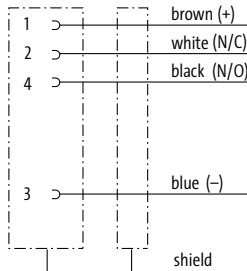

Approvals:  

\* only for products with UL/CSA approved cable

1 Form		08741	08761
Type		3-pole, shielded	4-pole, shielded
Circuit diagram			
Contact layout		<p>Female</p> 	<p>Female</p> 
2 Cable Type		Jacket Color	
Wire diameter 0.34 mm <sup>2</sup>		gray	black
PVC (UL/CSA)		200	600
PUR (UL/CSA), robots/C/tracks		240	640
		gray	black
		201	601
		241	641
3 Cable Length			
1.5 m		0150	
3.0 m		0300	
5.0 m		0500	
7.5 m		0750	
10.0 m		1000	
Technical Data			
Operating voltage		max. 50 V AC/60 V DC	
Protection		IP65, IP66K, IP67 inserted and tightened (EN 60529)	
Temperature range		-25...+85 °C, depending on cable quality	
Article No.			
The composition of your article number is explained on page 3.1.i		7 0 0 0	- - - - -
		1 Form	2 Cable Type
			3 Cable Length
Notes			
		Other versions on request. Differing cable lengths up to 2 m can be ordered in 0.2 m steps, from 2 m on in 0.5 m steps.	

# M8 ROUND PLUG CONNECTORS

With open ended wires

Female

90°



\* only for products with UL/CSA approved cable

1 Form		08781	08801
Type		3-pole, shielded	4-pole, shielded
Circuit diagram			
Contact layout		<p>Female</p>	<p>Female</p>
2 Cable Type	Jacket Color	Jacket Color	
Wire diameter 0.34 mm <sup>2</sup>		gray	black
PVC (UL/CSA)		200	600
PUR (UL/CSA), robots/Ctracks		240	640
3 Cable Length			
1.5 m		0150	
3.0 m		0300	
5.0 m		0500	
7.5 m		0750	
10.0 m		1000	
Technical Data			
Operating voltage		max. 50 V AC/60 V DC	
Protection		IP65, IP66K, IP67 inserted and tightened (EN 60529)	
Temperature range		-25...+85 °C, depending on cable quality	
Article No.			
The composition of your article number is explained on page 3.1.i		<div style="display: flex; justify-content: space-around; align-items: center;"> <span style="border-bottom: 1px solid black; padding: 0 5px;">7</span> <span style="border-bottom: 1px solid black; padding: 0 5px;">0</span> <span style="border-bottom: 1px solid black; padding: 0 5px;">0</span> <span style="border-bottom: 1px solid black; padding: 0 5px;">0</span> <span style="font-size: 2em;">-</span> <span style="border-bottom: 1px solid black; padding: 0 5px;"> </span> <span style="font-size: 2em;">-</span> <span style="border-bottom: 1px solid black; padding: 0 5px;"> </span> <span style="border-bottom: 1px solid black; padding: 0 5px;"> </span> </div>	
		<b>1</b> Form	<b>2</b> Cable Type
			<b>3</b> Cable Length
Notes		Other versions on request. Differing cable lengths up to 2 m can be ordered in 0.2 m steps, from 2 m on in 0.5 m steps.	

# M8 ROUND PLUG CONNECTORS

## Connection cables

– M8 - M8



\* only for products with UL/CSA approved cable

## Male

straight

## Female

straight



1 Form	88001	meX	88011	meX		
Type	3-pole		4-pole			
Circuit diagram						
Contact layout						
2 Cable Type	Jacket Color			Jacket Color		
Wire diameter 0.25 mm <sup>2</sup>	yellow	gray	black	yellow	gray	black
PVC (UL/CSA)	010	210	610	011	211	611
PUR/PVC (UL/CSA)	020	220	620	021	221	621
PUR (UL/CSA), robots/C-tracks	030	230	630	031	231	631
PUR (UL/CSA), welding spark	050	250	650	051	251	651
3 Cable Length						
0.3 m	0030					
0.6 m	0060					
1.0 m	0100					
1.5 m	0150					
2.0 m	0200					
Technical Data						
Operating voltage	max. 50 V AC/60 V DC					
Protection	IP65, IP66K, IP67 inserted and tightened (EN 60529)					
Temperature range	-25...+85 °C, depending on cable quality					
Article No.						
The composition of your article number is explained on page 3.1.i	7 0 0 0		-		-	
	7 0 0 5		M12 Lite (plastic hexagonal screw) on request			
	1 Form		2 Cable Type		3 Cable Length	
Notes	Other versions on request. Differing cable lengths up to 2 m can be ordered in 0.2 m steps, from 2 m on in 0.5 m steps.					

# M8 ROUND PLUG CONNECTORS

## Connection cables

– M8 - M8

### Male

straight

### Female

90°



\* only for products with UL/CSA approved cable

1 Form	88 021	me $\times$			88 031	me $\times$			
<b>Type</b>	3-pole			4-pole					
<b>Circuit diagram</b>									
<b>Contact layout</b>									
<b>2 Cable Type</b>	<b>Jacket Color</b>			<b>Jacket Color</b>					
Wire diameter 0.25 mm <sup>2</sup>	yellow	gray	black	yellow	gray	black			
PVC (UL/CSA)	010	210	610	011	211	611			
PUR/PVC (UL/CSA)	020	220	620	021	221	621			
PUR (UL/CSA), robots/C-tracks	030	230	630	031	231	631			
PUR (UL/CSA), welding spark	050	250	650	051	251	651			
<b>3 Cable Length</b>									
0.3 m	0030								
0.6 m	0060								
1.0 m	0100								
1.5 m	0150								
2.0 m	0200								
<b>Technical Data</b>									
Operating voltage	max. 50 V AC/60 V DC								
Protection	IP65, IP66K, IP67 inserted and tightened (EN 60529)								
Temperature range	-25...+85 °C, depending on cable quality								
<b>Article No.</b>									
The composition of your article number is explained on page 3.1.i	7 0 0 0 - - - - - - - - - -			7 0 0 5					
				M8 Lite (plastic hexagonal screw) on request					
	<b>1 Form</b>			<b>2 Cable Type</b>			<b>3 Cable Length</b>		
<b>Notes</b>									

# M8 ROUND PLUG CONNECTORS

## Connection cables

– M8 - M8



\* only for products with UL/CSA approved cable

## Male

straight

## Female

90° with LED



## 1 Form 88041 **mex**

Type **3-pole with 2 × LED (PNP)**  
(NPN) on request

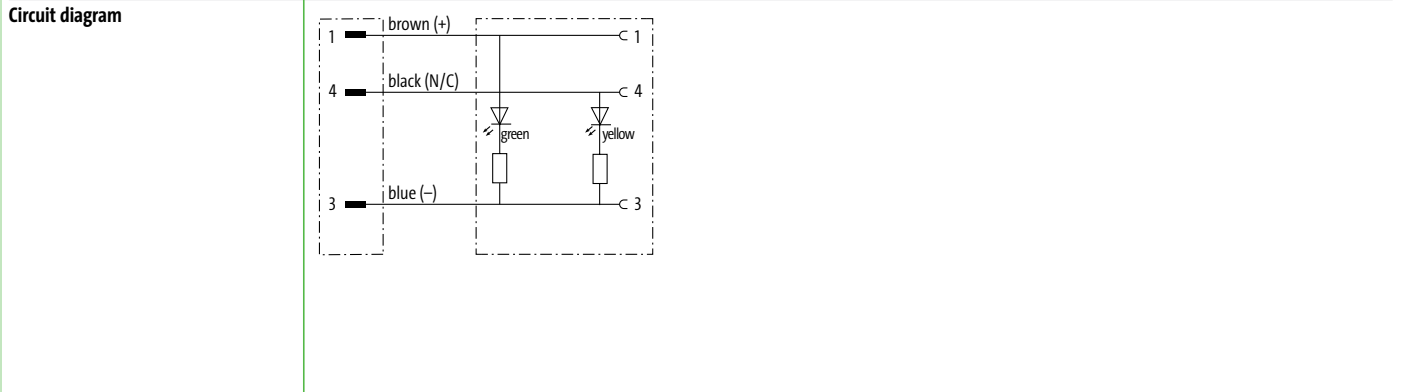

## 2 Cable Type Jacket Color

Wire diameter 0.25 mm <sup>2</sup>	yellow	gray	black
PVC (UL/CSA)	010	210	610
PUR/PVC (UL/CSA)	020	220	620
PUR (UL/CSA), robots/C-tracks	030	230	630
PUR (UL/CSA), welding spark	050	250	650

## 3 Cable Length

0.3 m	0030
0.6 m	0060
1.0 m	0100
1.5 m	0150
2.0 m	0200

## Technical Data

Operating voltage	24 V DC ±25%
Protection	IP65, IP66K, IP67 inserted and tightened (EN 60529)
Temperature range	-25...+85 °C, depending on cable quality

## Article No.

The composition of your article number is explained on page 3.1.i

7 0 0 0 - 8 8 0 4 1 - \_ \_ \_ \_

7 0 0 5 M8 Lite (plastic hexagonal screw) on request

**1** Form **2** Cable Type **3** Cable Length

Notes Other versions on request. Differing cable lengths up to 2 m can be ordered in 0.2 m steps, from 2 m on in 0.5 m steps.



# M8 ROUND PLUG CONNECTORS

## Connection cables

– M8 - M8

## Y connector

Male straight

## Females

straight



M8 Round Plug Connectors

<b>1 Form</b>	<b>87001</b>	<b>87011</b>	
	<b>4-/3-pole</b>	<b>3-pole</b>	
Type			
Circuit diagram			
Contact layout			
<b>2 Cable Type</b>	<b>Jacket Color</b>	<b>Jacket Color</b>	
	Wire diameter 0.25 mm <sup>2</sup>	<b>yellow</b> <b>gray</b> <b>black</b>	<b>yellow</b> <b>gray</b> <b>black</b>
	PVC (UL/CSA)	<b>010</b> <b>210</b> <b>610</b>	<b>010</b> <b>210</b> <b>610</b>
	PUR/PVC (UL/CSA)	<b>020</b> <b>220</b> <b>620</b>	<b>020</b> <b>220</b> <b>620</b>
	PUR (UL/CSA), robots/C-tracks	<b>030</b> <b>230</b> <b>630</b>	<b>030</b> <b>230</b> <b>630</b>
PUR (UL/CSA), welding spark	<b>050</b> <b>250</b> <b>650</b>	<b>050</b> <b>250</b> <b>650</b>	
<b>3 Cable Length</b>			
	0.3 m	<b>0030</b>	
	0.6 m	<b>0060</b>	
	1.0 m	<b>0100</b>	
	1.5 m	<b>0150</b>	
2.0 m	<b>0200</b>		
<b>Technical Data</b>			
Operating voltage	max. 50 V AC/60 V DC		
Protection	IP65, IP66K, IP67 inserted and tightened (EN 60529)		
Temperature range	-25...+85 °C, depending on cable quality		
<b>Article No.</b>			
The composition of your article number is explained on page 3.1.i	<b>7 0 0 0</b> - - - - -		
	<b>7 0 0 5</b> M8 Lite (plastic hexagonal screw) on request		
	<b>1 Form</b>	<b>2 Cable Type</b>	
		<b>3 Cable Length</b>	
<b>Notes</b>	Other versions on request. Differing cable lengths up to 2 m can be ordered in 0.2 m steps, from 2 m on in 0.5 m steps.		

# M8 ROUND PLUG CONNECTORS

## Connection cables

– M8 - M8

### Y connector

Male straight

### Females

straight

### Y connector

Female straight

### Male

straight



## 1 Form

**87061**

**87251**

Type  
Circuit diagram

4-pole

4-/3-pole

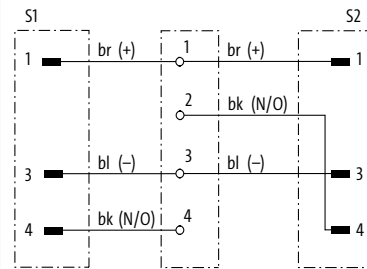
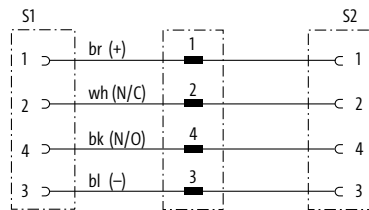

Contact layout

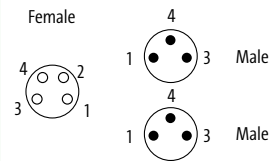
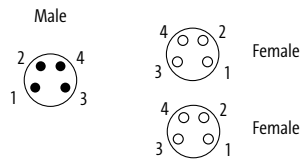

## 2 Cable Type

Jacket Color

Jacket Color

Wire diameter 0.25 mm<sup>2</sup>

PVC (UL/CSA)

PUR/PVC (UL/CSA)

PUR (UL/CSA), robots/C-tracks

PUR (UL/CSA), welding spark

	yellow	gray	black	yellow	gray	black
PVC (UL/CSA)	011	211	611	010	210	610
PUR/PVC (UL/CSA)	021	221	621	020	220	620
PUR (UL/CSA), robots/C-tracks	031	231	631	030	230	630
PUR (UL/CSA), welding spark	051	251	651	050	250	650

## 3 Cable Length

0.3 m	0030
0.6 m	0060
1.0 m	0100
1.5 m	0150
2.0 m	0200

## Technical Data

Operating voltage	max. 50 V AC/60 V DC
Protection	IP65, IP66K, IP67 inserted and tightened (EN 60529)
Temperature range	-25...+85 °C, depending on cable quality

## Article No.

The composition of your article number is explained on page 3.1.i

7 0 0 0

7 0 0 5

M8 Lite (plastic hexagonal screw) on request

**1** Form

**2** Cable Type

**3** Cable Length

Notes

Other versions on request. Differing cable lengths up to 2 m can be ordered in 0.2 m steps, from 2 m on in 0.5 m steps.

# M8 ROUND PLUG CONNECTORS

## Connection cables

– M8 - M8

### Male

straight

### Female

straight



\* only for products with UL/CSA approved cable

1 Form	89501	89511
Type	3-pole, shielded	4-pole, shielded
Circuit diagram		
Contact layout	<p>Male</p> <p>Female</p>	<p>Male</p> <p>Female</p>
2 Cable Type	Jacket Color	Jacket Color
Wire diameter 0.34 mm <sup>2</sup>	gray	black
PVC (UL/CSA)	200	600
PUR (UL/CSA), robots/Ctracks	240	640
3 Cable Length		
0.3 m	0030	
0.6 m	0060	
1.0 m	0100	
1.5 m	0150	
2.0 m	0200	
Technical Data		
Operating voltage	max. 50 V AC/60 V DC	
Protection	IP65, IP66K, IP67 inserted and tightened (EN 60529)	
Temperature range	-25...+85 °C, depending on cable quality	
Article No.		
The composition of your article number is explained on page 3.1.i	<p><b>7 0 0 0</b> - - - - -</p>	
	<b>1</b> Form	<b>2</b> Cable Type
		<b>3</b> Cable Length
Notes	Other versions on request. Differing cable lengths up to 2 m can be ordered in 0.2 m steps, from 2 m on in 0.5 m steps.	

# M8 ROUND PLUG CONNECTORS

## Connection cables

– M8 - M8



\* only for products with UL/CSA approved cable

## Male

straight

## Female

90°



### 1 Form

**89521**

**89531**

#### Type

3-pole, shielded

4-pole, shielded

#### Circuit diagram

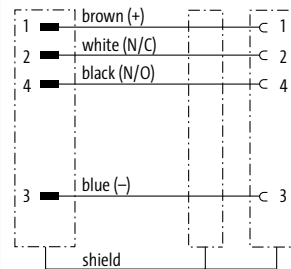
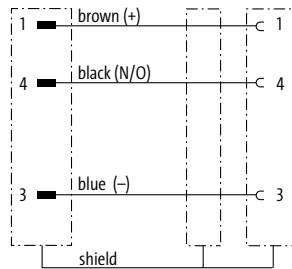

#### Contact layout

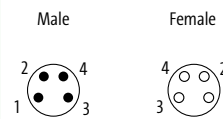
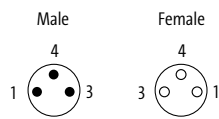

### 2 Cable Type

#### Jacket Color

#### Jacket Color

Wire diameter 0.34 mm<sup>2</sup>

PVC (UL/CSA)

PUR (UL/CSA), robots/Ctracks

	gray	black
	200	600
	240	640

	gray	black
	201	601
	241	641

### 3 Cable Length

0.3 m	0030
0.6 m	0060
1.0 m	0100
1.5 m	0150
2.0 m	0200

#### Technical Data

Operating voltage	max. 50 V AC/60 V DC
Protection	IP65, IP66K, IP67 inserted and tightened (EN 60529)
Temperature range	-25...+85 °C, depending on cable quality

#### Article No.

The composition of your article number is explained on page 3.1.i

7 0 0 0 - - - - -

**1** Form

**2** Cable Type

**3** Cable Length

#### Notes

Other versions on request. Differing cable lengths up to 2 m can be ordered in 0.2 m steps, from 2 m on in 0.5 m steps.

# M8 ROUND PLUG CONNECTORS

Field-wireable

– IDC terminals

**Male**

straight



**Female**

straight



Approvals:

M8 Round Plug Connectors

1 Form	08331 me*	08351 me*	08371 me*	08391 me*
Type	3-pole	4-pole	3-pole	4-pole
Circuit diagram				
Connection cross section	0.14...0.34 mm <sup>2</sup>			
Contact layout	Male 	Male 	Female 	Female 
<b>Technical Data</b>				
Operating voltage	max. 32 V AC/DC			
Rated surge voltage	0.8 kV			
Operating current per contact	max. 4 A			
Configuration	fully used			
Material group	IEC 60664-1, category I			
Over voltage category	3			
Isolation resistance	≥ 10 <sup>8</sup> Ohm			
Contact resistance	≤ 10 mOhm			
Connection cross section	0.14...0.34 mm <sup>2</sup> (conductor diameter min. 0.1 mm)			
Sealing range (cable Ø)	2.5...5.1 mm (gasket included)			
Outer wire Ø	1.0...1.6 mm			
Locking of ports	Screw thread M8 × 1 mm (recommended torque 0.4 Nm) self-securing			
Compression gland	M8 (SW9)			
Protection	IP67 inserted and tightened (EN 60529)			
Wire isolation	PVC, PP, TPE			
Material	PA			
Locking material	Zinc die casting, matte nickel plated			
Mating cycles	≥ 100			
Reconnection (cable)	10			
Temperature range	-25...+85 °C			
<b>Article No.</b>				
The composition of your article number is explained on page 3.1.i	<u>7</u> <u>0</u> <u>0</u> <u>0</u>	-	<u>0</u> <u>0</u> <u>0</u>	<u>0</u> <u>0</u> <u>0</u> <u>0</u>
	<b>1 Form</b>			
<b>Notes</b>	Other versions on request.			

# M8 ROUND PLUG CONNECTORS

Field-wireable  
– Screw terminals

Male  
straight

Female  
straight



Approvals:

M8 Round Plug Connectors

1 Form	08601 me*	08611 me*	08621 me*	08631 me*
Type	3-pole	4-pole	3-pole	4-pole
Circuit diagram				
Connection cross section	0.14...0.5 mm <sup>2</sup>			
Contact layout	<p>Male</p>	<p>Male</p>	<p>Female</p>	<p>Female</p>
<b>Technical Data</b>				
Operating voltage	max. 60 V AC/DC	max. 30 V AC/DC	max. 60 V AC/DC	max. 30 V AC/DC
Rated surge voltage	1.5 kV	0.8 kV	1.5 kV	0.8 kV
Operating current per contact	max. 4 A			
Connection cross section	0.14...0.5 mm <sup>2</sup>			
Sealing range (cable Ø)	2.5...5.0 mm			
Protection	IP67 inserted and tightened (EN 60529)			
Temperature range	-25...+85 °C			
<b>Article No.</b>				
The composition of your article number is explained on page 3.1.i	<u>7</u> <u>0</u> <u>0</u> <u>0</u>	-	-	<u>0</u> <u>0</u> <u>0</u> <u>0</u>
	<b>1 Form</b>			
<b>Notes</b>	Other versions on request.			

# M8 ROUND PLUG CONNECTORS

Field-wireable

– Screw terminals

Male

straight



Female

straight



M8 Round Plug Connectors



1 Form	08641 me×	08651 me×	08661 me×	08671 me×
Type	3-pole, shielded	4-pole, shielded	3-pole, shielded	4-pole, shielded
Circuit diagram				
Connection cross section	0.14...0.5 mm <sup>2</sup>			
Contact layout	<p>Male</p>	<p>Male</p>	<p>Female</p>	<p>Female</p>
<b>Technical Data</b>				
Operating voltage	max. 50 V AC/60 V DC	max. 30 V AC/DC	max. 60 V AC/DC	max. 30 V AC/DC
Rated surge voltage	1.5 kV	0.8 kV	1.5 kV	0.8 kV
Operating current per contact	max. 4 A			
Material group	IEC 60664-1, category III			
Connection cross section	0.14...0.5 mm <sup>2</sup>			
Sealing range (cable Ø)	3.5...5.5 mm			
Locking of ports	Screw thread M8 × 1 mm (recommended torque 0.4 Nm) self-securing			
Protection	IP67 inserted and tightened (EN 60529)			
Locking material	Brass, nickel plated			
Temperature range	-25...+85 °C			
<b>Article No.</b>				
The composition of your article number is explained on page 3.1.i	<u>7</u> <u>0</u> <u>0</u> <u>0</u>	-	-	<u>0</u> <u>0</u> <u>0</u> <u>0</u>
	<b>1 Form</b>			
<b>Notes</b>	Other versions on request.			

## M8 ROUND PLUG CONNECTORS

Labeling accessories			Art-No.
	<b>Slip-on cable sleeve</b> for ACS label plates (4 × 18 mm)	Cable diameter (4...6.5 mm)	7000-99004-000000
	<b>Snap-on cable sleeve</b> for ACS label plates (4 × 18 mm)	Cable diameter (4.2...5.6 mm)	7000-99005-000000
	for ACS label plates (4 × 18 mm)	Cable diameter (5...7 mm)	7000-99006-000000
	<b>ACS label plate</b> for self marking (4 × 18 mm)		7000-99002-000000
	<b>Colored ring M8/M12</b> sandy yellow	for unshielded molding	7000-99301-V011002
	zinc yellow	for unshielded molding	7000-99301-V011018
	redorange	for unshielded molding	7000-99301-V012008
	red	for unshielded molding	7000-99301-V013020
	violet	for unshielded molding	7000-99301-V014003
	purple	for unshielded molding	7000-99301-V014006
	blue	for unshielded molding	7000-99301-V015005
	green	for unshielded molding	7000-99301-V016018
	gray	for unshielded molding	7000-99301-V017035
	white	for unshielded molding	7000-99301-V019003
	black	for unshielded molding	7000-99301-V019004
Mounting accessories			Art-No.
	<b>Torque wrench set</b> M8 (0.4 Nm, SW9)	M8 data connectors	7000-99101-000000
	<b>Torque wrench</b> M8 (0.4 Nm, SW9)	M8 data connectors	7000-99091-000000
End fitting accessories			Art-No.
	<b>Tube adapter</b> snap-in for corrugated tube (size 13mm)	Cable diameter (4...7 mm)	7000-99081-000000
	<b>Gasket</b> MOSA M8		7000-99008-000000



# M8 ROUND PLUG CONNECTORS

Connection accessories			Art-No.
	<b>Universal holder</b> modular	M8 M12	7000-99801-0000000
	<b>Flange M8 male, pre-wired 0.2 m</b> suitable for mounting with wall thickness	max. 4.5 mm	7000-08552-9700020
	suitable for mounting with wall thickness	max. 4.5 mm	7000-08562-9690020
	<b>Flange M8 female, pre-wired 0.2 m</b> straight, A-coded, 3-pole		7000-08571-9700020
			7000-08581-9710020



# M12 ROUND PLUG CONNECTORS COMPREHENSIVE AND VERSATILE

- The right model for any application
- Shock and vibration resistant with integrated fastening
- Reliable – 100% tested

## M12 CONNECTORS – DESIGNED FOR MANY DIFFERENT CUSTOMER APPLICATIONS

Murrelektronik offers one of the most comprehensive M12 connector ranges on the market. Reliable, quick and easy assembly, a clear LED indicator: these are only a few of the features that make this product range one of the best.

### Features

- Combined hex screw with thread for secure connections
- Highly resistant, halogen-free PUR molding guarantees IP67/68 seal
- Wide range of cable material and color – always the right choice for your application

### With Open Ended Wires

 <p><b>M12 male</b></p> <ul style="list-style-type: none"> <li>• Straight</li> <li>• 90°</li> </ul> <p><i>Page 3.2.1</i></p>	 <p><b>M12 female</b></p> <ul style="list-style-type: none"> <li>• Straight</li> <li>• 90°</li> </ul> <p><i>Page 3.2.7</i></p>
 <p><b>M12 female with LED</b></p> <ul style="list-style-type: none"> <li>• Straight</li> <li>• 90°</li> </ul> <p><i>Page 3.2.13</i></p>	 <p><b>M12 male (shielded)</b></p> <ul style="list-style-type: none"> <li>• Straight</li> <li>• 90°</li> </ul> <p><i>Page 3.2.17</i></p>
 <p><b>M12 female (shielded)</b></p> <ul style="list-style-type: none"> <li>• Straight</li> <li>• 90°</li> </ul> <p><i>Page 3.2.23</i></p>	

## Connection Cables

		<p><b>M12 male</b></p> <ul style="list-style-type: none"> <li>• Straight</li> <li>• 90°</li> </ul>	<p><b>M12 female</b></p> <ul style="list-style-type: none"> <li>• Straight</li> <li>• 90°</li> <li>• 90° with LED</li> </ul> <p><i>Page 3.2.29</i></p>
		<p><b>M12 Y connector male</b></p> <ul style="list-style-type: none"> <li>• Straight</li> </ul>	<p><b>M12 female</b></p> <ul style="list-style-type: none"> <li>• Straight</li> <li>• 90°</li> <li>• 90° with LED</li> </ul> <p><i>Page 3.2.35</i></p>
		<p><b>M12 male (shielded)</b></p> <ul style="list-style-type: none"> <li>• Straight</li> </ul>	<p><b>M12 female (shielded)</b></p> <ul style="list-style-type: none"> <li>• Straight</li> </ul> <p><i>Page 3.2.38</i></p>

## Field-Wireable

	<p><b>Insulation Displacement Technology (IDC)</b></p>	<p><b>M12 male/female</b></p> <ul style="list-style-type: none"> <li>• Straight</li> <li>• 90°</li> </ul> <p><b>M12 female</b></p> <ul style="list-style-type: none"> <li>• 90° with LED</li> </ul> <p><i>Page 3.2.41</i></p>	
	<p><b>Screw terminals</b></p> <p><b>Screw terminals</b></p>	<p><b>M12 male/female</b></p> <ul style="list-style-type: none"> <li>• Straight</li> <li>• 90°</li> </ul> <p><b>M12 Y connector male</b></p> <ul style="list-style-type: none"> <li>• Straight</li> </ul> <p><i>Page 3.2.47</i></p>	
	<p><b>Screw terminals (shielded)</b></p>	<p><b>M12 male/female</b></p> <ul style="list-style-type: none"> <li>• Straight</li> <li>• 90°</li> </ul> <p><i>Page 3.2.54</i></p>	

# M12 ROUND PLUG CONNECTORS

With open ended wires

Male

straight



\* only for products with UL/CSA approved cable

1 Form	12001 me	12021 me	12041 me						
Type	3-pole	4-pole	5-pole						
Circuit diagram			<p>(* for cable type 126, 732, 219, 619)</p>						
Contact layout	<p>Male</p>	<p>Male</p>	<p>Male</p>						
2 Cable Type	Jacket Color								
Wire diameter 0.34 mm <sup>2</sup>	yellow	gray	black	yellow	gray	black	yellow	gray	black
PVC (UL/CSA)	013	213	613	014	214	614	015	215 (219)	615 (619)
PUR/PVC (UL/CSA)	023	223	623	024	224	624	025	225	625
PUR (UL/CSA), robots/C-tracks	033	233	633	034	234	634	035 (126)	235	635 (732)
PUR (UL/CSA), welding spark	053	253	653	054	254	654	055	255	655
3 Cable Length									
1.5 m	0150								
3.0 m	0300								
5.0 m	0500								
7.5 m	0750								
10.0 m	1000								
Technical Data									
Operating voltage	max. 250 V AC/DC						max. 125 V AC/DC		
Protection	IP65, IP66K, IP67 inserted and tightened (EN 60529)								
Temperature range	-25...+85 °C, depending on cable quality								
Article No.									
The composition of your article number is explained on page 3.1.i	<p><u>7</u> <u>0</u> <u>0</u> <u>0</u> - - - - - - - - - -</p> <p><u>7</u> <u>0</u> <u>0</u> <u>5</u> M12 Lite (plastic hexagonal screw) on request</p>								
	1 Form			2 Cable Type			3 Cable Length		
Notes	Other versions on request. Differing cable lengths up to 2 m can be ordered in 0.2 m steps, from 2 m on in 0.5 m steps.								

M12 Round Plug Connectors

# M12 ROUND PLUG CONNECTORS

With open ended wires

Male  
straight



Approvals:  

\* only for products with UL/CSA approved cable

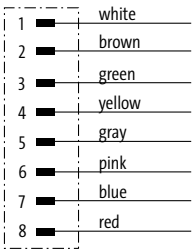
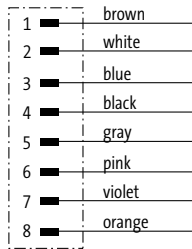
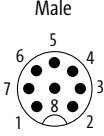
<b>1 Form</b>	<b>170 01</b>	<b>170 01</b>	
	Type 8-pole	Type 8-pole	
Circuit diagram			
Contact layout	<p>Male</p> 		
<b>2 Cable Type</b>	<b>Jacket Color</b>	<b>Jacket Color</b>	
	Wire diameter 0.25 mm <sup>2</sup>	gray      black      yellow	gray      black
	PVC (UL/CSA)	207      607	208      608
PUR (UL/CSA), robots/C/tracks	292      722      114	295	
<b>3 Cable Length</b>	1.5 m	0150	
	3.0 m	0300	
	5.0 m	0500	
	7.5 m	0750	
	10.0 m	1000	
<b>Technical Data</b>			
Operating voltage	max. 30 V AC/DC		
Protection	IP65, IP66K, IP67 inserted and tightened (EN 60529)		
Temperature range	-25...+85 °C, depending on cable quality		
<b>Article No.</b>			
The composition of your article number is explained on page 3.1.i	<u>7</u> <u>0</u> <u>0</u> <u>0</u> - - - - - - - - - -	- - - - -	
	<u>7</u> <u>0</u> <u>0</u> <u>5</u> M12 Lite (plastic hexagonal screw) on request		
	<b>1 Form</b>	<b>2 Cable Type</b>	<b>3 Cable Length</b>
<b>Notes</b>	Other versions on request. Differing cable lengths up to 2 m can be ordered in 0.2 m steps, from 2 m on in 0.5 m steps.		

M12 Round Plug Connectors

# M12 ROUND PLUG CONNECTORS

With open ended wires

Male

straight

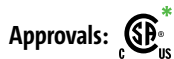

\* only for products with UL/CSA approved cable

<b>1 Form</b>	<b>19001</b>	
Type	12-pole	
Circuit diagram		
Contact layout		
<b>2 Cable Type</b>	<b>Jacket Color</b>	
Wire diameter 0.14 mm <sup>2</sup>	gray	black
PVC (UL/CSA)	209	609
PUR (UL/CSA), robots/C-tracks		705
Wire diameter 0.25 mm <sup>2</sup>		
PUR (UL/CSA), robots/C-tracks	301	
PUR (UL/CSA), welding spark	302	
<b>3 Cable Length</b>		
1.5 m	0150	
3.0 m	0300	
5.0 m	0500	
7.5 m	0750	
10.0 m	1000	
<b>Technical Data</b>		
Operating voltage	max. 30 V AC/DC	
Protection	IP65, IP66K, IP67 inserted and tightened (EN 60529)	
Temperature range	-25...+85 °C, depending on cable quality	
<b>Article No.</b>		
The composition of your article number is explained on page 3.1.i	<p><u>7</u> <u>0</u> <u>0</u> <u>0</u> - <u>1</u> <u>9</u> <u>0</u> <u>0</u> <u>1</u> - _ _ _</p> <p><u>7</u> <u>0</u> <u>0</u> <u>5</u> M12 Lite (plastic hexagonal screw) on request</p>	
	<b>1 Form</b>	<b>2 Cable Type</b>
		<b>3 Cable Length</b>
<b>Notes</b>	Other versions on request. Differing cable lengths up to 2 m can be ordered in 0.2 m steps, from 2 m on in 0.5 m steps.	

M12 Round Plug Connectors

# M12 ROUND PLUG CONNECTORS

With open ended wires

Male  
90°



Approvals:

\* only for products with UL/CSA approved cable

1 Form	12081 me $\times$	12101 me $\times$	12121 me $\times$						
Type	3-pole	4-pole	5-pole						
Circuit diagram			<p>(* for cable type 126, 732, 219, 619)</p>						
Contact layout									
2 Cable Type	Jacket Color								
Wire diameter 0.34 mm <sup>2</sup>	yellow	gray	black	yellow	gray	black	yellow	gray	black
PVC (UL/CSA)	013	213	613	014	214	614	015	215 (219)	615 (619)
PUR/PVC (UL/CSA)	023	223	623	024	224	624	025	225	625
PUR (UL/CSA), robots/C-tracks	033	233	633	034	234	634	035 (126)	235	635 (732)
PUR (UL/CSA), welding spark	053	253	653	054	254	654	055	255	655
3 Cable Length									
1.5 m	0150								
3.0 m	0300								
5.0 m	0500								
7.5 m	0750								
10.0 m	1000								
Technical Data									
Operating voltage	max. 250 V AC/DC						max. 125 V AC/DC		
Protection	IP65, IP66K, IP67 inserted and tightened (EN 60529)								
Temperature range	-25...+85 °C, depending on cable quality								
Article No.									
The composition of your article number is explained on page 3.1.i	7 0 0 0 - - - - - - - - - -								
	7 0 0 5 M12 Lite (plastic hexagonal screw) on request								
	1 Form			2 Cable Type			3 Cable Length		
Notes	Other versions on request. Differing cable lengths up to 2 m can be ordered in 0.2 m steps, from 2 m on in 0.5 m steps.								

M12 Round Plug Connectors

# M12 ROUND PLUG CONNECTORS

With open ended wires

Male

90°

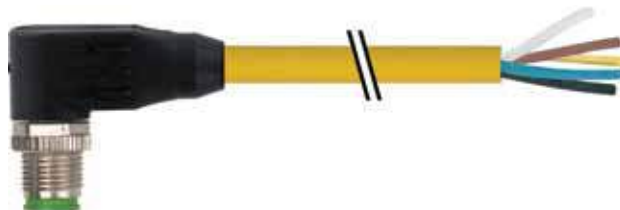

\* only for products with UL/CSA approved cable

1 Form	17021	17021																																
Type	8-pole	8-pole																																
Circuit diagram	<table border="1"> <tr><td>1</td><td>white</td></tr> <tr><td>2</td><td>brown</td></tr> <tr><td>3</td><td>green</td></tr> <tr><td>4</td><td>yellow</td></tr> <tr><td>5</td><td>gray</td></tr> <tr><td>6</td><td>pink</td></tr> <tr><td>7</td><td>blue</td></tr> <tr><td>8</td><td>red</td></tr> </table>	1	white	2	brown	3	green	4	yellow	5	gray	6	pink	7	blue	8	red	<table border="1"> <tr><td>1</td><td>brown</td></tr> <tr><td>2</td><td>white</td></tr> <tr><td>3</td><td>blue</td></tr> <tr><td>4</td><td>black</td></tr> <tr><td>5</td><td>gray</td></tr> <tr><td>6</td><td>pink</td></tr> <tr><td>7</td><td>violet</td></tr> <tr><td>8</td><td>orange</td></tr> </table>	1	brown	2	white	3	blue	4	black	5	gray	6	pink	7	violet	8	orange
1	white																																	
2	brown																																	
3	green																																	
4	yellow																																	
5	gray																																	
6	pink																																	
7	blue																																	
8	red																																	
1	brown																																	
2	white																																	
3	blue																																	
4	black																																	
5	gray																																	
6	pink																																	
7	violet																																	
8	orange																																	
Contact layout	<p>Male</p>																																	
2 Cable Type	Jacket Color	Jacket Color																																
Wire diameter 0.25 mm <sup>2</sup>	gray    black    yellow	gray    black																																
PVC (UL/CSA)	207    607	208    608																																
PUR (UL/CSA), robots/Ctracks	292    722    114	295																																
3 Cable Length																																		
1.5 m	0150																																	
3.0 m	0300																																	
5.0 m	0500																																	
7.5 m	0750																																	
10.0 m	1000																																	
Technical Data																																		
Operating voltage	max. 30 V AC/DC																																	
Protection	IP65, IP66K, IP67 inserted and tightened (EN 60529)																																	
Temperature range	-25...+85 °C, depending on cable quality																																	
Article No.																																		
The composition of your article number is explained on page 3.1.i	<p><u>7</u> <u>0</u> <u>0</u> <u>0</u> -</p> <p><u>7</u> <u>0</u> <u>0</u> <u>5</u>    M12 Lite (plastic hexagonal screw) on request</p>																																	
	<b>1</b> Form	<b>2</b> Cable Type																																
		<b>3</b> Cable Length																																
Notes																																		
	Other versions on request. Differing cable lengths up to 2 m can be ordered in 0.2 m steps, from 2 m on in 0.5 m steps.																																	



# M12 ROUND PLUG CONNECTORS

With open ended wires

Male  
90°



Approvals: 

\* only for products with UL/CSA approved cable

## 1 Form 19021

Type 12-pole

Circuit diagram	
1	brown
2	blue
3	white
4	green
5	pink
6	yellow
7	black
8	gray
9	red
10	violet
11	gray/pink
12	red/blue

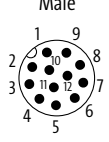
Contact layout	
	Male 

## 2 Cable Type Jacket Color

Wire diameter 0.14 mm <sup>2</sup>	gray	black
PVC (UL/CSA)	209	609
PUR (UL/CSA), robots/C-tracks		705
Wire diameter 0.25 mm <sup>2</sup>		
PUR (UL/CSA), robots/C-tracks	301	
PUR (UL/CSA), welding spark	302	

## 3 Cable Length

1.5 m	0150
3.0 m	0300
5.0 m	0500
7.5 m	0750
10.0 m	1000

## Technical Data

Operating voltage	max. 30 V AC/DC
Protection	IP65, IP66K, IP67 inserted and tightened (EN 60529)
Temperature range	-25...+85 °C, depending on cable quality

## Article No.

The composition of your article number is explained on page 3.1.i	<u>7</u> <u>0</u> <u>0</u> <u>0</u> - <u>1</u> <u>9</u> <u>0</u> <u>2</u> <u>1</u> - _ _ _ _
	<u>7</u> <u>0</u> <u>0</u> <u>5</u> M12 Lite (plastic hexagonal screw) on request

**1** Form **2** Cable Type **3** Cable Length

Notes

Other versions on request. Differing cable lengths up to 2 m can be ordered in 0.2 m steps, from 2 m on in 0.5 m steps.

# M12 ROUND PLUG CONNECTORS

With open ended wires

Female  
straight



\* only for products with UL/CSA approved cable

1 Form	12181	meX			12221	meX			12241
Type	3-pole				4-pole				5-pole
Circuit diagram									<p>(* for cable type 126, 732, 219, 619)</p>
Contact layout	<p>Female</p>				<p>Female</p>				<p>Female</p>
2 Cable Type	Jacket Color			Jacket Color			Jacket Color		
Wire diameter 0.34 mm <sup>2</sup>	yellow	gray	black	yellow	gray	black	yellow	gray	black
PVC (UL/CSA)	013	213	613	014	214	614	015	215 (219)	615 (619)
PUR/PVC (UL/CSA)	023	223	623	024	224	624	025	225	625
PUR (UL/CSA), robots/C-tracks	033	233	633	034	234	634	035 (126)	235	635 (732)
PUR (UL/CSA), welding spark	053	253	653	054	254	654	055	255	655
3 Cable Length									
1.5 m	0150								
3.0 m	0300								
5.0 m	0500								
7.5 m	0750								
10.0 m	1000								
Technical Data									
Operating voltage	max. 250 V AC/DC						max. 125 V AC/DC		
Protection	IP65, IP66K, IP67 inserted and tightened (EN 60529)								
Temperature range	-25...+85 °C, depending on cable quality								
Article No.									
The composition of your article number is explained on page 3.1.i	7 0 0 0			-			-		
	7 0 0 5			M12 Lite (plastic hexagonal screw) on request					
	1 Form			2 Cable Type			3 Cable Length		
Notes	Other versions on request. Differing cable lengths up to 2 m can be ordered in 0.2 m steps, from 2 m on in 0.5 m steps.								

# M12 ROUND PLUG CONNECTORS

With open ended wires

Female  
straight



Approvals:

\* only for products with UL/CSA approved cable

M12 Round Plug Connectors

1 Form		17041	17041
Type		8-pole	8-pole
Circuit diagram			

Contact layout

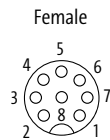

2 Cable Type	Jacket Color			Jacket Color	
	Wire diameter 0.25 mm <sup>2</sup>	gray	black	yellow	
PVC (UL/CSA)	207	607		gray	black
PUR (UL/CSA), robots/Ctracks	292	722	114	295	608

3 Cable Length	
1.5 m	0150
3.0 m	0300
5.0 m	0500
7.5 m	0750
10.0 m	1000

### Technical Data

Operating voltage	max. 30 V AC/DC
Protection	IP65, IP66K, IP67 inserted and tightened (EN 60529)
Temperature range	-25...+85 °C, depending on cable quality

### Article No.

The composition of your article number is explained on page 3.1.i

7 0 0 0 - - - - -

7 0 0 5 M12 Lite (plastic hexagonal screw) on request

**1** Form **2** Cable Type **3** Cable Length

Notes

Other versions on request. Differing cable lengths up to 2 m can be ordered in 0.2 m steps, from 2 m on in 0.5 m steps.

# M12 ROUND PLUG CONNECTORS

With open ended wires

Female  
straight



Approvals: 

\* only for products with UL/CSA approved cable

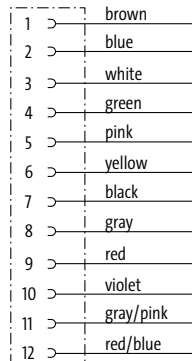
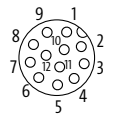
<b>1 Form</b>		<b>19041</b>	
Type	12-pole		
Circuit diagram			
Contact layout	<p>Female</p> 		
<b>2 Cable Type</b>		<b>Jacket Color</b>	
Wire diameter 0.14 mm <sup>2</sup>		gray	black
PVC (UL/CSA)		209	609
PUR (UL/CSA), robots/C-tracks			705
Wire diameter 0.25 mm <sup>2</sup>			
PUR (UL/CSA), robots/C-tracks		301	
PUR (UL/CSA), welding spark		302	
<b>3 Cable Length</b>			
1.5 m	0150		
3.0 m	0300		
5.0 m	0500		
7.5 m	0750		
10.0 m	1000		
<b>Technical Data</b>			
Operating voltage	max. 30 V AC/DC		
Protection	IP65, IP66K, IP67 inserted and tightened (EN 60529)		
Temperature range	-25...+85 °C, depending on cable quality		
<b>Article No.</b>			
The composition of your article number is explained on page 3.1.i	<p><u>7</u> <u>0</u> <u>0</u> <u>0</u> - <u>1</u> <u>9</u> <u>0</u> <u>4</u> <u>1</u> - _ _ _</p>		
	<p><u>7</u> <u>0</u> <u>0</u> <u>5</u> M12 Lite (plastic hexagonal screw) on request</p>		
	<b>1 Form</b>	<b>2 Cable Type</b>	<b>3 Cable Length</b>
<b>Notes</b>			
Other versions on request. Differing cable lengths up to 2 m can be ordered in 0.2 m steps, from 2 m on in 0.5 m steps.			

# M12 ROUND PLUG CONNECTORS

With open ended wires

Female  
90°



Approvals:

\* only for products with UL/CSA approved cable

1 Form	12321	12341	12361						
Type	3-pole	4-pole	5-pole						
Circuit diagram			<p>(* for cable type 126, 732, 219, 619)</p>						
Contact layout									
2 Cable Type	Jacket Color								
Wire diameter 0.34 mm <sup>2</sup>	yellow	gray	black	yellow	gray	black	yellow	gray	black
PVC (UL/CSA)	013	213	613	014	214	614	015	215 (219)	615 (619)
PUR/PVC (UL/CSA)	023	223	623	024	224	624	025	225	625
PUR (UL/CSA), robots/C-tracks	033	233	633	034	234	634	035 (126)	235	635 (732)
PUR (UL/CSA), welding spark	053	253	653	054	254	654	055	255	655
3 Cable Length									
1.5 m	0150								
3.0 m	0300								
5.0 m	0500								
7.5 m	0750								
10.0 m	1000								
Technical Data									
Operating voltage	max. 250 V AC/DC						max. 125 V AC/DC		
Protection	IP65, IP66K, IP67 inserted and tightened (EN 60529)								
Temperature range	-25...+85 °C, depending on cable quality								
Article No.									
The composition of your article number is explained on page 3.1.i	7 0 0 0 - - - - - - - - - -								
	7 0 0 5 M12 Lite (plastic hexagonal screw) on request								
	1 Form			2 Cable Type			3 Cable Length		
Notes	Other versions on request. Differing cable lengths up to 2 m can be ordered in 0.2 m steps, from 2 m on in 0.5 m steps.								

# M12 ROUND PLUG CONNECTORS

With open ended wires

Female

90°



\* only for products with UL/CSA approved cable

<b>1 Form</b>	<b>170 61</b>	<b>170 61</b>		
	<b>8-pole</b>	<b>8-pole</b>		
<b>Type</b>	<b>8-pole</b>	<b>8-pole</b>		
<b>Circuit diagram</b>				
<b>Contact layout</b>	<p>Female</p>			
<b>2 Cable Type</b>	<b>Jacket Color</b>	<b>Jacket Color</b>		
Wire diameter 0.25 mm <sup>2</sup>	gray    black    yellow		gray    black	
PVC (UL/CSA)	207    607		208    608	
PUR (UL/CSA), robots/Ctracks	292    722    114		295	
<b>3 Cable Length</b>				
1.5 m	<b>0150</b>			
3.0 m	<b>0300</b>			
5.0 m	<b>0500</b>			
7.5 m	<b>0750</b>			
10.0 m	<b>1000</b>			
<b>Technical Data</b>				
Operating voltage	max. 30 V AC/DC			
Protection	IP65, IP66K, IP67 inserted and tightened (EN 60529)			
Temperature range	-25...+85 °C, depending on cable quality			
<b>Article No.</b>				
The composition of your article number is explained on page 3.1.i	<p><b>7 0 0 0</b> - - - - - - - - - -</p>			
	<p><b>7 0 0 5</b> M12 Lite (plastic hexagonal screw) on request</p>			
	<b>1 Form</b>	<b>2 Cable Type</b>	<b>3 Cable Length</b>	
<b>Notes</b>	Other versions on request. Differing cable lengths up to 2 m can be ordered in 0.2 m steps, from 2 m on in 0.5 m steps.			

# M12 ROUND PLUG CONNECTORS

With open ended wires

Female  
90°

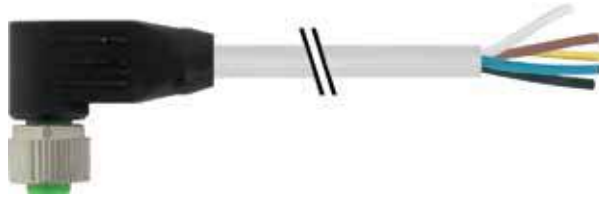

Approvals: 

\* only for products with UL/CSA approved cable

## 1 Form 19061

Type 12-pole

Circuit diagram	
1	brown
2	blue
3	white
4	green
5	pink
6	yellow
7	black
8	gray
9	red
10	violet
11	gray/pink
12	red/blue

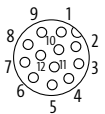
Contact layout	Female
	

## 2 Cable Type Jacket Color

Wire diameter 0.14 mm <sup>2</sup>	gray	black
PVC (UL/CSA)	209	609
PUR (UL/CSA), robots/C-tracks		705
Wire diameter 0.25 mm <sup>2</sup>		
PUR (UL/CSA), robots/C-tracks	301	
PUR (UL/CSA), welding spark	302	

## 3 Cable Length

1.5 m	0150
3.0 m	0300
5.0 m	0500
7.5 m	0750
10.0 m	1000

## Technical Data

Operating voltage	max. 30 V AC/DC
Protection	IP65, IP66K, IP67 inserted and tightened (EN 60529)
Temperature range	-25...+85 °C, depending on cable quality

## Article No.

The composition of your article number is explained on page 3.1.i	<u>7</u> <u>0</u> <u>0</u> <u>0</u> - <u>1</u> <u>9</u> <u>0</u> <u>6</u> <u>1</u> - _ _ _ _
	<u>7</u> <u>0</u> <u>0</u> <u>5</u> M12 Lite (plastic hexagonal screw) on request

**1** Form **2** Cable Type **3** Cable Length

## Notes

Other versions on request. Differing cable lengths up to 2 m can be ordered in 0.2 m steps, from 2 m on in 0.5 m steps.

# M12 ROUND PLUG CONNECTORS

With open ended wires

**Female**  
straight, with LED



**Female**  
90° with LED



\* only for products with UL/CSA approved cable

1 Form		12261			12381		
Type		3-pole with 2 x LED (PNP) (NPN) on request			3-pole with 2 x LED (PNP) (NPN) on request		
Circuit diagram							
Contact layout		Female 					
2 Cable Type		Jacket Color			Jacket Color		
Wire diameter 0.34 mm <sup>2</sup>		yellow	gray	black	yellow	gray	black
PVC (UL/CSA)		013	213	613	013	213	613
PUR/PVC (UL/CSA)		023	223	623	023	223	623
PUR (UL/CSA), robots/C-tracks		033	233	633	033	233	633
PUR (UL/CSA), welding spark		053	253	653	053	253	653
3 Cable Length							
1.5 m		0150					
3.0 m		0300					
5.0 m		0500					
7.5 m		0750					
10.0 m		1000					
Technical Data							
Operating voltage		24 V DC ±25%					
Protection		IP65, IP66K, IP67 inserted and tightened (EN 60529)					
Temperature range		-25...+85 °C, depending on cable quality					
Article No.							
The composition of your article number is explained on page 3.1.i		7 0 0 0			-		
		7 0 0 5			M12 Lite (plastic hexagonal screw) on request		
		1 Form		2 Cable Type		3 Cable Length	
Notes		Other versions on request. Differing cable lengths up to 2 m can be ordered in 0.2 m steps, from 2 m on in 0.5 m steps.					



# M12 ROUND PLUG CONNECTORS

With open ended wires

**Female**  
straight, with LED



**Female**  
90° with LED



Approvals:  

\* only for products with UL/CSA approved cable

## 1 Form

### 12281

### 12401

Type

4-pole with 2 × LED (PNP)  
(NPN) on request

4-pole with 2 × LED (PNP)  
(NPN) on request

Circuit diagram

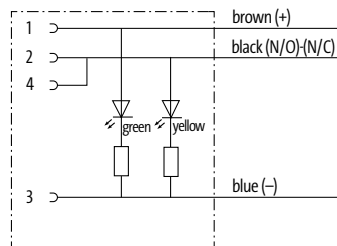

Contact layout

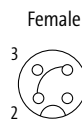

## 2 Cable Type

### Jacket Color

### Jacket Color

Wire diameter 0.34 mm<sup>2</sup>

	yellow	gray	black	yellow	gray	black
PVC (UL/CSA)	013	213	613	013	213	613
PUR/PVC (UL/CSA)	023	223	623	023	223	623
PUR (UL/CSA), robots/C-tracks	033	233	633	033	233	633
PUR (UL/CSA), welding spark	053	253	653	053	253	653

## 3 Cable Length

1.5 m	0150
3.0 m	0300
5.0 m	0500
7.5 m	0750
10.0 m	1000

## Technical Data

Operating voltage	24 V DC ±25%
Protection	IP65, IP66K, IP67 inserted and tightened (EN 60529)
Temperature range	-25...+85 °C, depending on cable quality

## Article No.

The composition of your article number is explained on page 3.1.i

7 0 0 0

7 0 0 5

M12 Lite (plastic hexagonal screw) on request

1

Form

2

Cable Type

3

Cable Length

Notes

Other versions on request. Differing cable lengths up to 2 m can be ordered in 0.2 m steps, from 2 m on in 0.5 m steps.

# M12 ROUND PLUG CONNECTORS

With open ended wires

**Female**  
straight, with LED



**Female**  
90° with LED



\* only for products with UL/CSA approved cable

1 Form	12231	12421				
Type	4-pole with 3 × LED (PNP) (NPN) on request	4-pole with 3 × LED (PNP) (NPN) on request				
Circuit diagram						
Contact layout	<p>Female</p>					
2 Cable Type	Jacket Color			Jacket Color		
Wire diameter 0.34 mm <sup>2</sup>	yellow	gray	black	yellow	gray	black
PVC (UL/CSA)	014	214	614	014	214	614
PUR/PVC (UL/CSA)	024	224	624	024	224	624
PUR (UL/CSA), robots/C-tracks	034	234	634	034	234	634
PUR (UL/CSA), welding spark	054	254	654	054	254	654
3 Cable Length						
1.5 m	0150					
3.0 m	0300					
5.0 m	0500					
7.5 m	0750					
10.0 m	1000					
Technical Data						
Operating voltage	24 V DC ±25%					
Protection	IP65, IP66K, IP67 inserted and tightened (EN 60529)					
Temperature range	-25...+85 °C, depending on cable quality					
Article No.						
The composition of your article number is explained on page 3.1.i	<u>7</u> <u>0</u> <u>0</u> <u>0</u> - - - - -			- - - - -		
	<u>7</u> <u>0</u> <u>0</u> <u>5</u>			M12 Lite (plastic hexagonal screw) on request		
	<b>1</b>	<b>Form</b>	<b>2</b>	<b>Cable Type</b>	<b>3</b>	<b>Cable Length</b>
Notes	Other versions on request. Differing cable lengths up to 2 m can be ordered in 0.2 m steps, from 2 m on in 0.5 m steps.					

# M12 ROUND PLUG CONNECTORS

With open ended wires

**Female**  
straight, with LED



**Female**  
90° with LED



Approvals: 

\* only for products with UL/CSA approved cable

<b>1 Form</b>	<b>12251</b>	<b>12441</b>
Approvals		cULus *
Type	5-pole with 3 × LED (PNP) (NPN) on request	5-pole with 3 × LED (PNP) (NPN) on request

Circuit diagram

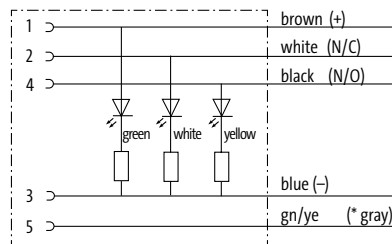

(\* for cable type 126, 732, 219, 619)

Contact layout

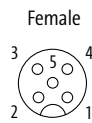

<b>2 Cable Type</b>	<b>Jacket Color</b>			<b>Jacket Color</b>		
Wire diameter 0.34 mm <sup>2</sup>	yellow	gray	black	yellow	gray	black
PVC (UL/CSA)	015	215 (219)	615 (619)	015	215 (219)	615 (619)
PUR/PVC (UL/CSA)	025	225	625	025	225	625
PUR (UL/CSA), robots/C-tracks	035 (126)	235	635 (732)	035 (126)	235	635 (732)
PUR (UL/CSA), welding spark	055	255	655	055	255	655

<b>3 Cable Length</b>	
1.5 m	0150
3.0 m	0300
5.0 m	0500
7.5 m	0750
10.0 m	1000

**Technical Data**

Operating voltage	24 V DC ±25%
Protection	IP65, IP66K, IP67 inserted and tightened (EN 60529)
Temperature range	-25...+85 °C, depending on cable quality

**Article No.**

The composition of your article number is explained on page 3.1.i

**7 0 0 0**

**7 0 0 5**

M12 Lite (plastic hexagonal screw) on request

**1 Form**      **2 Cable Type**      **3 Cable Length**

Notes

Other versions on request. Differing cable lengths up to 2 m can be ordered in 0.2 m steps, from 2 m on in 0.5 m steps.

# M12 ROUND PLUG CONNECTORS

With open ended wires

Male  
straight



\* only for products with UL/CSA approved cable

1 Form	13061	13081	13101
Type	3-pole, shielded	4-pole, shielded	5-pole, shielded
Circuit diagram			<p>(* for cable type 203, 603, 243, 643)</p>
Contact layout			
2 Cable Type	Jacket Color	Jacket Color	Jacket Color
Wire diameter 0.34 mm <sup>2</sup>	gray    black	gray    black	gray    black
PVC (UL/CSA)	200    600	201    601	202 (203)    602 (603)
PUR (UL/CSA), robots/Ctracks	240    640	241    641	242 (243)    642 (643)
3 Cable Length			
1.5 m	0150		
3.0 m	0300		
5.0 m	0500		
7.5 m	0750		
10.0 m	1000		
Technical Data			
Operating voltage	max. 60 V AC/DC		
Protection	IP65, IP66K, IP67 inserted and tightened (EN 60529)		
Temperature range	-25...+85 °C, depending on cable quality		
Article No.			
The composition of your article number is explained on page 3.1.i	<div style="display: flex; justify-content: space-around; align-items: center;"> <span style="border: 1px solid black; padding: 2px 5px;">7</span> <span style="border: 1px solid black; padding: 2px 5px;">0</span> <span style="border: 1px solid black; padding: 2px 5px;">0</span> <span style="border: 1px solid black; padding: 2px 5px;">0</span> <span style="font-size: 2em;">-</span> <span style="border: 1px solid black; padding: 2px 5px;"> </span> <span style="font-size: 2em;">-</span> <span style="border: 1px solid black; padding: 2px 5px;"> </span> <span style="border: 1px solid black; padding: 2px 5px;"> </span> <span style="border: 1px solid black; padding: 2px 5px;"> </span> </div>		
	<b>1 Form</b>	<b>2 Cable Type</b>	<b>3 Cable Length</b>
Notes	Other versions on request. Differing cable lengths up to 2 m can be ordered in 0.2 m steps, from 2 m on in 0.5 m steps.		

# M12 ROUND PLUG CONNECTORS

With open ended wires

Male  
straight



\* only for products with UL/CSA approved cable

M12 Round Plug Connectors

1 Form	17081	17081
Type	8-pole, shielded	8-pole, shielded
Circuit diagram		

Contact layout

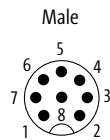

2 Cable Type	Jacket Color	Jacket Color
Wire diameter 0.25 mm <sup>2</sup>	gray	black
PVC (UL/CSA)	204	205
PUR (UL/CSA), robots/Ctracks	291	717

3 Cable Length	
1.5 m	0150
3.0 m	0300
5.0 m	0500
7.5 m	0750
10.0 m	1000

## Technical Data

Operating voltage	max. 30 V AC/DC
Protection	IP65, IP66K, IP67 inserted and tightened (EN 60529)
Temperature range	-25...+85 °C, depending on cable quality

## Article No.

The composition of your article number is explained on page 3.1.i

7 0 0 0 - - - - -

**1** Form      **2** Cable Type      **3** Cable Length

Notes

Other versions on request. Differing cable lengths up to 2 m can be ordered in 0.2 m steps, from 2 m on in 0.5 m steps.

# M12 ROUND PLUG CONNECTORS

With open ended wires

**Male**

straight



Approvals: 

\* only for products with UL/CSA approved cable

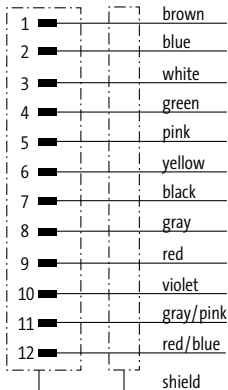
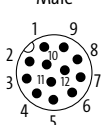
<b>1 Form</b>	<b>19301</b>	
Type	12-pole, shielded	
Circuit diagram		
Contact layout	<p>Male</p> 	
<b>2 Cable Type</b>	<b>Jacket Color</b>	
Wire diameter 0.14 mm <sup>2</sup>		<b>black</b>
PVC (UL/CSA)		<b>703</b>
PUR (UL/CSA), robots/Ctracks		<b>706</b>
<b>3 Cable Length</b>		
1.5 m		<b>0150</b>
3.0 m		<b>0300</b>
5.0 m		<b>0500</b>
7.5 m		<b>0750</b>
10.0 m		<b>1000</b>
<b>Technical Data</b>		
Operating voltage	max. 30 V AC/DC	
Protection	IP65, IP66K, IP67 inserted and tightened (EN 60529)	
Temperature range	-25...+85 °C, depending on cable quality	
<b>Article No.</b>		
The composition of your article number is explained on page 3.1.i	<p><b>7 0 0 0 - 1 9 3 0 1 - - - -</b></p>	
	<b>1 Form</b>	<b>2 Cable Type</b>
		<b>3 Cable Length</b>
<b>Notes</b>	Other versions on request. Differing cable lengths up to 2 m can be ordered in 0.2 m steps, from 2 m on in 0.5 m steps.	

# M12 ROUND PLUG CONNECTORS

With open ended wires

Male  
90°



Approvals:  

\* only for products with UL/CSA approved cable

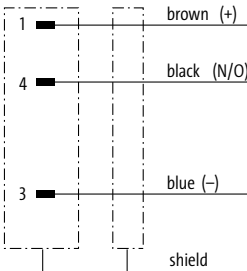
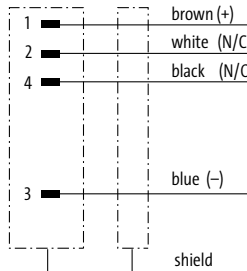
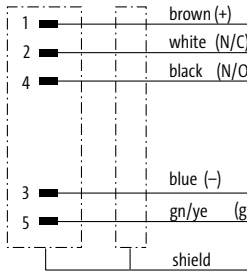
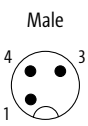
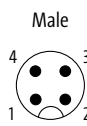
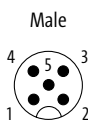
1 Form	13121	13141	13161	
Type	3-pole, shielded	4-pole, shielded	5-pole, shielded	
Circuit diagram			 <p>(* for cable type 203, 603, 243, 643)</p>	
Contact layout				
2 Cable Type	Jacket Color		Jacket Color	
	Wire diameter 0.34 mm <sup>2</sup>	gray    black	gray    black	gray    black
	PVC (UL/CSA)	200    600	201    601	202 (203)    602 (603)
PUR (UL/CSA), robots/Ctracks	240    640	241    641	242 (243)    642 (643)	
3 Cable Length	1.5 m	0150		
	3.0 m	0300		
	5.0 m	0500		
	7.5 m	0750		
	10.0 m	1000		
<b>Technical Data</b>				
Operating voltage	max. 60 V AC/DC			
Protection	IP65, IP66K, IP67 inserted and tightened (EN 60529)			
Temperature range	-25...+85 °C, depending on cable quality			
<b>Article No.</b>				
The composition of your article number is explained on page 3.1.i	<div style="display: flex; justify-content: space-around; align-items: center;"> <span style="border-bottom: 1px solid black; padding: 0 5px;">7</span> <span style="border-bottom: 1px solid black; padding: 0 5px;">0</span> <span style="border-bottom: 1px solid black; padding: 0 5px;">0</span> <span style="border-bottom: 1px solid black; padding: 0 5px;">0</span> <span style="font-size: 2em;">-</span> <span style="border-bottom: 1px solid black; padding: 0 5px;"> </span> <span style="font-size: 2em;">-</span> <span style="border-bottom: 1px solid black; padding: 0 5px;"> </span> <span style="border-bottom: 1px solid black; padding: 0 5px;"> </span> <span style="border-bottom: 1px solid black; padding: 0 5px;"> </span> </div>			
	<b>1</b>	<b>2</b>	<b>3</b>	
	Form	Cable Type	Cable Length	
<b>Notes</b>				
Other versions on request. Differing cable lengths up to 2 m can be ordered in 0.2 m steps, from 2 m on in 0.5 m steps.				

# M12 ROUND PLUG CONNECTORS

With open ended wires

Male  
90°

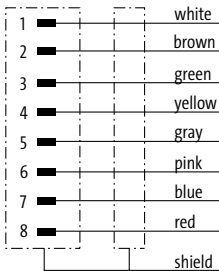
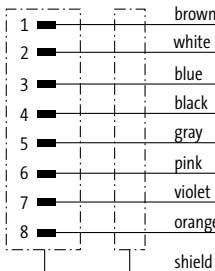
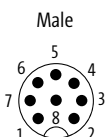

Approvals:    
\* only for products with UL/CSA approved cable

1 Form		17101	17101
Type		8-pole, shielded	8-pole, shielded
Circuit diagram			
Contact layout		<p>Male</p> 	
2 Cable Type		Jacket Color	
Wire diameter 0.25 mm <sup>2</sup>		gray	black
PVC (UL/CSA)		204	205
PUR (UL/CSA), robots/Ctracks		291	717
3 Cable Length		Jacket Color	
1.5 m		gray	
3.0 m		black	
5.0 m		205	
7.5 m		294	
10.0 m		715	
Technical Data			
Operating voltage		max. 30 V AC/DC	
Protection		IP65, IP66K, IP67 inserted and tightened (EN 60529)	
Temperature range		-25...+85 °C, depending on cable quality	
Article No.			
The composition of your article number is explained on page 3.1.i		<p><b>7 0 0 0</b> - - - - - - - - - -</p>	
		<b>1</b> Form	<b>2</b> Cable Type
			<b>3</b> Cable Length
Notes		Other versions on request. Differing cable lengths up to 2 m can be ordered in 0.2 m steps, from 2 m on in 0.5 m steps.	

M12 Round Plug Connectors



# M12 ROUND PLUG CONNECTORS

With open ended wires

Male

90°



Approvals: 

\* only for products with UL/CSA approved cable

## 1 Form

**19321**

Type

12-pole, shielded

Circuit diagram

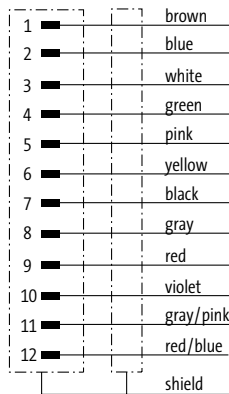

Contact layout

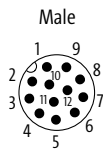

## 2 Cable Type

Jacket Color

Wire diameter 0.14 mm<sup>2</sup>

black

PVC (UL/CSA)

703

PUR (UL/CSA), robots/Ctracks

706

## 3 Cable Length

1.5 m

0150

3.0 m

0300

5.0 m

0500

7.5 m

0750

10.0 m

1000

## Technical Data

Operating voltage

max. 30 V AC/DC

Protection

IP65, IP66K, IP67 inserted and tightened (EN 60529)

Temperature range

-25...+85 °C, depending on cable quality

## Article No.

The composition of your article number is explained on page 3.1.i

7 0 0 0

-

1 9 3 2 1

-

\_\_\_\_

\_\_\_\_

**1**

Form

**2**

Cable Type

**3**

Cable Length

Notes

Other versions on request. Differing cable lengths up to 2 m can be ordered in 0.2 m steps, from 2 m on in 0.5 m steps.

# M12 ROUND PLUG CONNECTORS

With open ended wires

Female  
straight



\* only for products with UL/CSA approved cable

1 Form	13181	13201	13221
Type	3-pole, shielded	4-pole, shielded	5-pole, shielded
Circuit diagram			<p>(* for cable type 203, 603, 243, 643)</p>
Contact layout	<p>Female</p>	<p>Female</p>	<p>Female</p>
2 Cable Type	Jacket Color	Jacket Color	Jacket Color
Wire diameter 0.34 mm <sup>2</sup>	gray black	gray black	gray black
PVC (UL/CSA)	200 600	201 601	202 (203) 602 (603)
PUR (UL/CSA), robots/Ctracks	240 640	241 641	242 (243) 642 (643)
3 Cable Length			
1.5 m	0150		
3.0 m	0300		
5.0 m	0500		
7.5 m	0750		
10.0 m	1000		
Technical Data			
Operating voltage	max. 60 V AC/DC		
Protection	IP65, IP66K, IP67 inserted and tightened (EN 60529)		
Temperature range	-25...+85 °C, depending on cable quality		
Article No.			
The composition of your article number is explained on page 3.1.i	<div style="display: flex; justify-content: space-around; align-items: center;"> <span style="border: 1px solid black; padding: 2px;">7</span> <span style="border: 1px solid black; padding: 2px;">0</span> <span style="border: 1px solid black; padding: 2px;">0</span> <span style="border: 1px solid black; padding: 2px;">0</span> <span style="font-size: 2em;">-</span> <span style="border: 1px solid black; padding: 2px;"> </span> <span style="font-size: 2em;">-</span> <span style="border: 1px solid black; padding: 2px;"> </span> <span style="border: 1px solid black; padding: 2px;"> </span> <span style="border: 1px solid black; padding: 2px;"> </span> </div>		
	<b>1</b> Form	<b>2</b> Cable Type	<b>3</b> Cable Length
Notes	Other versions on request. Differing cable lengths up to 2 m can be ordered in 0.2 m steps, from 2 m on in 0.5 m steps.		

# M12 ROUND PLUG CONNECTORS

With open ended wires

Female  
straight



Approvals: 

\* only for products with UL/CSA approved cable

M12 Round Plug Connectors

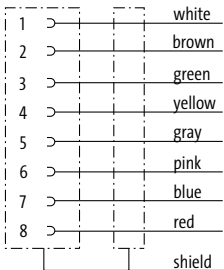
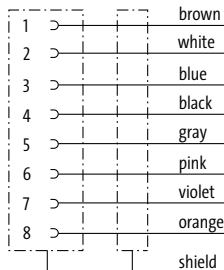
1 Form	17121	17121
Type	8-pole, shielded	8-pole, shielded
Circuit diagram		

Contact layout

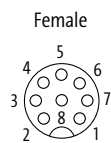

2 Cable Type	Jacket Color	Jacket Color
Wire diameter 0.25 mm <sup>2</sup>	gray	black
PVC (UL/CSA)	204	205
PUR (UL/CSA), robots/Ctracks	291	717

3 Cable Length	
1.5 m	0150
3.0 m	0300
5.0 m	0500
7.5 m	0750
10.0 m	1000

## Technical Data

Operating voltage	max. 30 V AC/DC
Protection	IP65, IP66K, IP67 inserted and tightened (EN 60529)
Temperature range	-25...+85 °C, depending on cable quality

## Article No.

The composition of your article number is explained on page 3.1.i

7 0 0 0 - - - - -

**1** Form      **2** Cable Type      **3** Cable Length

Notes

Other versions on request. Differing cable lengths up to 2 m can be ordered in 0.2 m steps, from 2 m on in 0.5 m steps.

# M12 ROUND PLUG CONNECTORS

With open ended wires

Female

straight



Approvals: 

\* only for products with UL/CSA approved cable

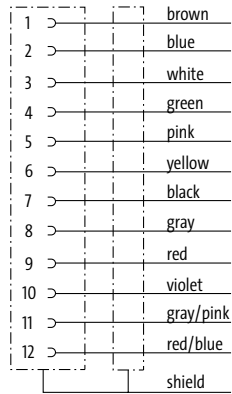
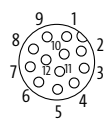
<b>1 Form</b>	<b>19341</b>	
Type	12-pole, shielded	
Circuit diagram		
Contact layout	<p>Female</p> 	
<b>2 Cable Type</b>	<b>Jacket Color</b>	
Wire diameter 0.14 mm <sup>2</sup>	black	
PVC (UL/CSA)	703	
PUR (UL/CSA), robots/Ctracks	706	
<b>3 Cable Length</b>		
1.5 m	0150	
3.0 m	0300	
5.0 m	0500	
7.5 m	0750	
10.0 m	1000	
<b>Technical Data</b>		
Operating voltage	max. 30 V AC/DC	
Protection	IP67 inserted and tightened (EN 60529)	
Temperature range	-25...+85 °C, depending on cable quality	
<b>Article No.</b>		
The composition of your article number is explained on page 3.1.i	<p><b>7 0 0 0</b> - <b>1 9 3 4 1</b> -      -      -</p>	
	<b>1 Form</b>	<b>2 Cable Type</b>
		<b>3 Cable Length</b>
<b>Notes</b>	Other versions on request. Differing cable lengths up to 2 m can be ordered in 0.2 m steps, from 2 m on in 0.5 m steps.	

# M12 ROUND PLUG CONNECTORS





With open ended wires

Female  
90°

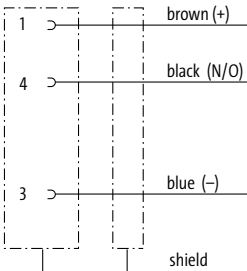
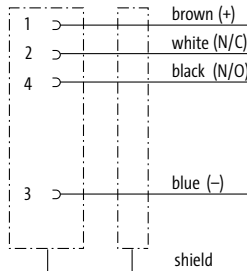
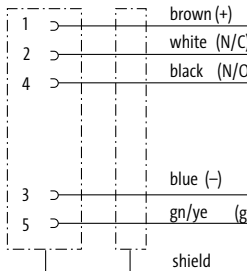

Approvals:  

\* only for products with UL/CSA approved cable

1 Form	13241	13261	13281
Type	3-pole, shielded	4-pole, shielded	5-pole, shielded
Circuit diagram			 <p>(* for cable type 203, 603, 243, 643)</p>
Contact layout	<p>Female</p> 	<p>Female</p> 	<p>Female</p> 
<b>2 Cable Type</b>	<b>Jacket Color</b>	<b>Jacket Color</b>	<b>Jacket Color</b>
Wire diameter 0.34 mm <sup>2</sup>	gray      black	gray      black	gray      black
PVC (UL/CSA)	200      600	201      601	202 (203)      602 (603)
PUR (UL/CSA), robots/Ctracks	240      640	241      641	242 (243)      642 (643)
<b>3 Cable Length</b>			
1.5 m	0150		
3.0 m	0300		
5.0 m	0500		
7.5 m	0750		
10.0 m	1000		
<b>Technical Data</b>			
Operating voltage	max. 60 V AC/DC		
Protection	IP65, IP66K, IP67 inserted and tightened (EN 60529)		
Temperature range	-25...+85 °C, depending on cable quality		
<b>Article No.</b>			
The composition of your article number is explained on page 3.1.i	<div style="display: flex; justify-content: space-around; align-items: center;"> <span style="border-bottom: 1px solid black; padding: 0 5px;">7</span> <span style="border-bottom: 1px solid black; padding: 0 5px;">0</span> <span style="border-bottom: 1px solid black; padding: 0 5px;">0</span> <span style="border-bottom: 1px solid black; padding: 0 5px;">0</span> <span style="font-size: 2em;">-</span> <span style="border-bottom: 1px solid black; padding: 0 5px;"> </span> <span style="font-size: 2em;">-</span> <span style="border-bottom: 1px solid black; padding: 0 5px;"> </span> <span style="border-bottom: 1px solid black; padding: 0 5px;"> </span> <span style="border-bottom: 1px solid black; padding: 0 5px;"> </span> </div>		
	<b>1 Form</b>	<b>2 Cable Type</b>	<b>3 Cable Length</b>
<b>Notes</b>	Other versions on request. Differing cable lengths up to 2 m can be ordered in 0.2 m steps, from 2 m on in 0.5 m steps.		

# M12 ROUND PLUG CONNECTORS

With open ended wires

Female

90°



\* only for products with UL/CSA approved cable

1 Form		17141	17141
Type	8-pole, shielded	8-pole, shielded	8-pole, shielded
Circuit diagram			
Contact layout	<p>Female</p>		
2 Cable Type		Jacket Color	
Wire diameter 0.25 mm <sup>2</sup>		gray	black
PVC (UL/CSA)		204	205
PUR (UL/CSA), robots/Ctracks		291	717
		gray	black
		294	715
3 Cable Length			
1.5 m	0150		
3.0 m	0300		
5.0 m	0500		
7.5 m	0750		
10.0 m	1000		
Technical Data			
Operating voltage	max. 30 V AC/DC		
Protection	IP65, IP66K, IP67 inserted and tightened (EN 60529)		
Temperature range	-25...+85 °C, depending on cable quality		
Article No.			
The composition of your article number is explained on page 3.1.i	<p><b>7 0 0 0</b> - - - - -</p>		
	<b>1</b> Form	<b>2</b> Cable Type	<b>3</b> Cable Length
Notes			
		Other versions on request. Differing cable lengths up to 2 m can be ordered in 0.2 m steps, from 2 m on in 0.5 m steps.	

# M12 ROUND PLUG CONNECTORS

With open ended wires

Female  
90°



Approvals: 

\* only for products with UL/CSA approved cable

## 1 Form

**19361**

Type **12-pole, shielded**

Circuit diagram

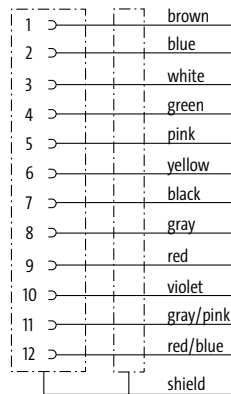

Contact layout

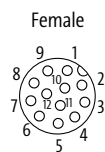

## 2 Cable Type

Jacket Color

Wire diameter 0.14 mm<sup>2</sup>  
PVC (UL/CSA)  
PUR (UL/CSA), robots/Ctracks

**black**  
**703**  
**706**

## 3 Cable Length

1.5 m **0150**  
3.0 m **0300**  
5.0 m **0500**  
7.5 m **0750**  
10.0 m **1000**

## Technical Data

Operating voltage max. 30 V AC/DC  
Protection IP65, IP66K, IP67 inserted and tightened (EN 60529)  
Temperature range -25...+85 °C, depending on cable quality

## Article No.

The composition of your article number is explained on page 3.1.i

7 0 0 0

-

1 9 3 6 1

-

\_\_\_\_

\_\_\_\_

**1** Form

**2** Cable Type

**3** Cable Length

Notes

Other versions on request. Differing cable lengths up to 2 m can be ordered in 0.2 m steps, from 2 m on in 0.5 m steps.

# M12 ROUND PLUG CONNECTORS

Connection cables

– M12 - M12

Male

straight

Female

straight



\* only for products with UL/CSA approved cable

1 Form	40001	40021	40041									
Type	3-pole	4-pole	5-pole									
Circuit diagram			<p>(* for cable type 126, 732, 219, 619)</p>									
Contact layout												
2 Cable Type	Jacket Color											
Wire diameter 0.34 mm <sup>2</sup>	yellow	gray	black	yellow	gray	black	yellow	gray	black			
PVC (UL/CSA)	013	213	613	014	214	614	015	215 (219)	615 (619)			
PUR/PVC (UL/CSA)	023	223	623	024	224	624	025	225	625			
PUR (UL/CSA), robots/C-tracks	033	233	633	034	234	634	035 (126)	235	635 (732)			
PUR (UL/CSA), welding spark	053	253	653	054	254	654	055	255	655			
3 Cable Length												
0.3 m	0030											
0.6 m	0060											
1.0 m	0100											
1.5 m	0150											
2.0 m	0200											
Technical Data												
Operating voltage	max. 250 V AC/DC						max. 125 V AC/DC					
Protection	IP65, IP66K, IP67 inserted and tightened (EN 60529)											
Temperature range	-25...+85 °C, depending on cable quality											
Article No.												
The composition of your article number is explained on page 3.1.i	7 0 0 0			-			-			-		
	7 0 0 5			M12 Lite (plastic hexagonal screw) on request								
	1 Form			2 Cable Type			3 Cable Length					
Notes	Other versions on request. Differing cable lengths up to 2 m can be ordered in 0.2 m steps, from 2 m on in 0.5 m steps.											



# M12 ROUND PLUG CONNECTORS

## Connection cables

– M12 - M12

## Male

straight

## Female

straight



Approvals:  

\* only for products with UL/CSA approved cable

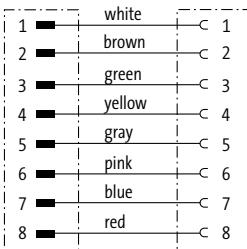
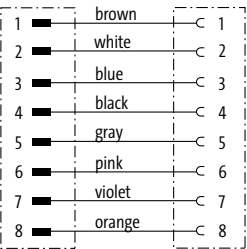
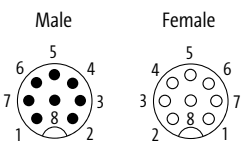
1 Form		48001			48001		
Type		8-pole			8-pole		
Circuit diagram							
Contact layout							
2 Cable Type		Jacket Color			Jacket Color		
Wire diameter 0.25 mm <sup>2</sup>		gray	black	yellow		gray	black
PVC (UL/CSA)		207	607			208	608
PUR (UL/CSA), robots/Ctracks		292	722	114		295	
3 Cable Length							
0.3 m		0030					
0.6 m		0060					
1.0 m		0100					
1.5 m		0150					
2.0 m		0200					
Technical Data							
Operating voltage		max. 30 V AC/DC					
Protection		IP65, IP66K, IP67 inserted and tightened (EN 60529)					
Temperature range		-25...+85 °C, depending on cable quality					
Article No.							
The composition of your article number is explained on page 3.1.i		7 0 0 0					
		7 0 0 5			M12 Lite (plastic hexagonal screw) on request		
		1 Form		2 Cable Type		3 Cable Length	
Notes		Other versions on request. Differing cable lengths up to 2 m can be ordered in 0.2 m steps, from 2 m on in 0.5 m steps.					

# M12 ROUND PLUG CONNECTORS

## Connection cables

– M12 - M12

### Male

straight

### Female

straight



Approvals: 

\* only for products with UL/CSA approved cable

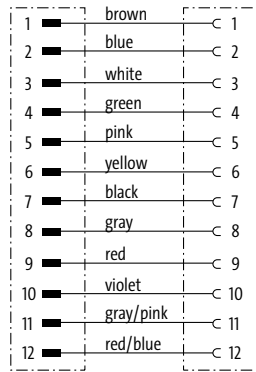
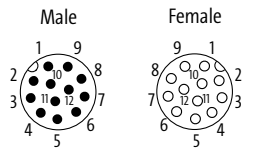
<b>1 Form</b>	<b>53001</b>		
Type	12-pole		
Circuit diagram			
Contact layout			
<b>2 Cable Type</b>	<b>Jacket Color</b>		
Wire diameter 0.14 mm <sup>2</sup>	gray	black	
PVC (UL/CSA)	209	609	
PUR (UL/CSA), robots/C-tracks		705	
Wire diameter 0.25 mm <sup>2</sup>			
PUR (UL/CSA), robots/C-tracks	301		
PUR (UL/CSA), welding spark	302		
<b>3 Cable Length</b>			
0.3 m	0030		
0.6 m	0060		
1.0 m	0100		
1.5 m	0150		
2.0 m	0200		
<b>Technical Data</b>			
Operating voltage	max. 30 V AC/DC		
Protection	IP65, IP66K, IP67 inserted and tightened (EN 60529)		
Temperature range	-25...+85 °C, depending on cable quality		
<b>Article No.</b>			
The composition of your article number is explained on page 3.1.i	<p><u>7</u> <u>0</u> <u>0</u> <u>0</u> - <u>5</u> <u>3</u> <u>0</u> <u>0</u> <u>1</u> - _ _ _</p> <p><u>7</u> <u>0</u> <u>0</u> <u>5</u> M12 Lite (plastic hexagonal screw) on request</p>		
	<b>1 Form</b>	<b>2 Cable Type</b>	<b>3 Cable Length</b>
<b>Notes</b>	Other versions on request. Differing cable lengths up to 2 m can be ordered in 0.2 m steps, from 2 m on in 0.5 m steps.		

# M12 ROUND PLUG CONNECTORS

## Connection cables

– M12 - M12

**Male**

straight

**Female**

90°



Approvals:

\* only for products with UL/CSA approved cable

1 Form	40101	40121	40141						
	Type	3-pole	4-pole	5-pole					
Circuit diagram			<p>(* for cable type 126, 732, 219, 619)</p>						
Contact layout									
2 Cable Type	Jacket Color								
Wire diameter 0.34 mm <sup>2</sup>	yellow	gray	black	yellow	gray	black	yellow	gray	black
PVC (UL/CSA)	013	213	613	014	214	614	015	215 (219)	615 (619)
PUR/PVC (UL/CSA)	023	223	623	024	224	624	025	225	625
PUR (UL/CSA), robots/C-tracks	033	233	633	034	234	634	035 (126)	235	635 (732)
PUR (UL/CSA), welding spark	053	253	653	054	254	654	055	255	655
3 Cable Length									
0.3 m	0030								
0.6 m	0060								
1.0 m	0100								
1.5 m	0150								
2.0 m	0200								
Technical Data									
Operating voltage	max. 250 V AC/DC						max. 125 V AC/DC		
Protection	IP65, IP66K, IP67 inserted and tightened (EN 60529)								
Temperature range	-25...+85 °C, depending on cable quality								
Article No.									
The composition of your article number is explained on page 3.1.i	7 0 0 0			-			-		
	7 0 0 5			M12 Lite (plastic hexagonal screw) on request					
	1 Form			2 Cable Type			3 Cable Length		
Notes	Other versions on request. Differing cable lengths up to 2 m can be ordered in 0.2 m steps, from 2 m on in 0.5 m steps.								

# M12 ROUND PLUG CONNECTORS

Connection cables

– M12 - M12

**Male**

straight

**Female**

90° with LED



\* only for products with UL/CSA approved cable

1 Form	4 0 3 2 1	4 0 3 4 1	4 0 3 6 1						
<b>Type</b>	3-pole with 2 × LED (PNP) (NPN) on request	4-pole with 3 × LED (PNP) (NPN) on request	5-pole with 3 × LED (PNP) (NPN) on request						
<b>Circuit diagram</b>			<p>(* for cable type 126, 732, 219, 619)</p>						
<b>Contact layout</b>									
<b>2 Cable Type</b>	<b>Jacket Color</b>								
<b>Wire diameter 0.34 mm<sup>2</sup></b>	<b>yellow</b>	<b>gray</b>	<b>black</b>	<b>yellow</b>	<b>gray</b>	<b>black</b>	<b>yellow</b>	<b>gray</b>	<b>black</b>
PVC (UL/CSA)	013	213	613	014	214	614	015	215 (219)	615 (619)
PUR/PVC (UL/CSA)	023	223	623	024	224	624	025	225	625
PUR (UL/CSA), robots/C-tracks	033	233	633	034	234	634	035 (126)	235	635 (732)
PUR (UL/CSA), welding spark	053	253	653	054	254	654	055	255	655
<b>3 Cable Length</b>									
0.3 m	0030								
0.6 m	0060								
1.0 m	0100								
1.5 m	0150								
2.0 m	0200								
<b>Technical Data</b>									
Operating voltage	24 V DC ±25%								
Protection	IP65, IP66K, IP67 inserted and tightened (EN 60529)								
Temperature range	-25...+85 °C, depending on cable quality								
<b>Article No.</b>									
The composition of your article number is explained on page 3.1.i	<p><b>7 0 0 0</b> - - - - - - - - -</p> <p><b>7 0 0 5</b> M12 Lite (plastic hexagonal screw) on request</p>								
	<b>1 Form</b>			<b>2 Cable Type</b>			<b>3 Cable Length</b>		
<b>Notes</b>	Other versions on request. Differing cable lengths up to 2 m can be ordered in 0.2 m steps, from 2 m on in 0.5 m steps.								

# M12 ROUND PLUG CONNECTORS

## Connection cables

– M12 - M12

### Male

straight

### Female

90° with LED



Approvals:  

\* only for products with UL/CSA approved cable

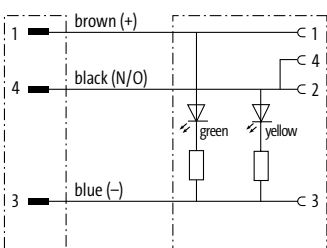
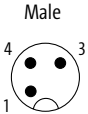
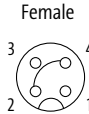
<b>1 Form</b>	<b>40381</b>		
	3-pole with 2 × LED (PNP) (NPN) on request		
Type			
Circuit diagram			
Contact layout			
<b>2 Cable Type</b>	<b>Jacket Color</b>		
Wire diameter 0.34 mm <sup>2</sup>	<b>yellow</b>	gray	black
PVC (UL/CSA)	<b>013</b>	213	613
PUR/PVC (UL/CSA)	<b>023</b>	223	623
PUR (UL/CSA), robots/C-tracks	<b>033</b>	233	633
PUR (UL/CSA), welding spark	<b>053</b>	253	653
<b>3 Cable Length</b>			
0.3 m	<b>0030</b>		
0.6 m	<b>0060</b>		
1.0 m	<b>0100</b>		
1.5 m	<b>0150</b>		
2.0 m	<b>0200</b>		
<b>Technical Data</b>			
Operating voltage	24 V DC ±25%		
Protection	IP65, IP66K, IP67 inserted and tightened (EN 60529)		
Temperature range	-25...+85 °C, depending on cable quality		
<b>Article No.</b>			
The composition of your article number is explained on page 3.1.i	<b>7 0 0 0</b> - <b>4 0 3 8 1</b> - _ _ _ _		
	<b>7 0 0 5</b> M12 Lite (plastic hexagonal screw) on request		
	<b>1 Form</b>	<b>2 Cable Type</b>	<b>3 Cable Length</b>
<b>Notes</b>	Other versions on request. Differing cable lengths up to 2 m can be ordered in 0.2 m steps, from 2 m on in 0.5 m steps.		

M12 Round Plug Connectors

# M12 ROUND PLUG CONNECTORS

## Connection cables

– M12 - M12

### Y connector

Male straight

### Females

straight



\* only for products with UL/CSA approved cable

1 Form	40701	40721
Type	4-/3-pole	4-pole
Circuit diagram		
Contact layout		
2 Cable Type	Jacket Color	Jacket Color
Wire diameter 0.34 mm <sup>2</sup>	yellow    gray    black	yellow    gray    black
PVC (UL/CSA)	013    213    613	013    213    613
PUR/PVC (UL/CSA)	023    223    623	023    223    623
PUR (UL/CSA), robots/C-tracks	033    233    633	033    233    633
PUR (UL/CSA), welding spark	053    253    653	053    253    653
3 Cable Length		
0.3 m	0030	
0.6 m	0060	
1.0 m	0100	
1.5 m	0150	
2.0 m	0200	
Technical Data		
Operating voltage	max. 250 V AC/DC	
Protection	IP65, IP66K, IP67 inserted and tightened (EN 60529)	
Temperature range	-25...+85 °C, depending on cable quality	
Article No.		
The composition of your article number is explained on page 3.1.i	<p><b>7 0 0 0</b> - - - - -</p> <p><b>7 0 0 5</b> M12 Lite (plastic hexagonal screw) on request</p>	
	<b>1 Form</b>	<b>2 Cable Type</b>
		<b>3 Cable Length</b>
Notes	Other versions on request. Differing cable lengths up to 2 m can be ordered in 0.2 m steps, from 2 m on in 0.5 m steps.	

# M12 ROUND PLUG CONNECTORS

## Connection cables

– M12 - M12

## Y connector

Male straight

## Females

90°



\* only for products with UL/CSA approved cable

1 Form	40741	40761				
	Type	4-/3-pole	4-pole			
Circuit diagram						
Contact layout						
2 Cable Type	Jacket Color					
Wire diameter 0.34 mm <sup>2</sup>	yellow	gray	black	yellow	gray	black
PVC (UL/CSA)	013	213	613	013	213	613
PUR/PVC (UL/CSA)	023	223	623	023	223	623
PUR (UL/CSA), robots/C-tracks	033	233	633	033	233	633
PUR (UL/CSA), welding spark	053	253	653	053	253	653
3 Cable Length						
0.3 m	0030					
0.6 m	0060					
1.0 m	0100					
1.5 m	0150					
2.0 m	0200					
Technical Data						
Operating voltage	max. 250 V AC/DC					
Protection	IP65, IP66K, IP67 inserted and tightened (EN 60529)					
Temperature range	-25...+85 °C, depending on cable quality					
Article No.						
The composition of your article number is explained on page 3.1.i	7 0 0 0 - - - - -					
	7 0 0 5 M12 Lite (plastic hexagonal screw) on request					
	1 Form		2 Cable Type		3 Cable Length	
Notes	Other versions on request. Differing cable lengths up to 2 m can be ordered in 0.2 m steps, from 2 m on in 0.5 m steps.					

# M12 ROUND PLUG CONNECTORS

## Connection cables

– M12 - M12

### Y connector

Male straight

### Females

90° with LED



\* only for products with UL/CSA approved cable

1 Form	40781	40801																														
Type	4-/3-pole LED (yellow/green)	4-pole LED (yellow/green)																														
Circuit diagram																																
Contact layout																																
2 Cable Type	Jacket Color	Jacket Color																														
Wire diameter 0.34 mm <sup>2</sup>	<table border="1"> <thead> <tr> <th style="background-color: yellow;">yellow</th> <th style="background-color: gray;">gray</th> <th style="background-color: black;">black</th> </tr> </thead> <tbody> <tr> <td>013</td> <td>213</td> <td>613</td> </tr> <tr> <td>023</td> <td>223</td> <td>623</td> </tr> <tr> <td>033</td> <td>233</td> <td>633</td> </tr> <tr> <td>053</td> <td>253</td> <td>653</td> </tr> </tbody> </table>	yellow	gray	black	013	213	613	023	223	623	033	233	633	053	253	653	<table border="1"> <thead> <tr> <th style="background-color: yellow;">yellow</th> <th style="background-color: gray;">gray</th> <th style="background-color: black;">black</th> </tr> </thead> <tbody> <tr> <td>013</td> <td>213</td> <td>613</td> </tr> <tr> <td>023</td> <td>223</td> <td>623</td> </tr> <tr> <td>033</td> <td>233</td> <td>633</td> </tr> <tr> <td>053</td> <td>253</td> <td>653</td> </tr> </tbody> </table>	yellow	gray	black	013	213	613	023	223	623	033	233	633	053	253	653
yellow	gray	black																														
013	213	613																														
023	223	623																														
033	233	633																														
053	253	653																														
yellow	gray	black																														
013	213	613																														
023	223	623																														
033	233	633																														
053	253	653																														
3 Cable Length																																
0.3 m	0030																															
0.6 m	0060																															
1.0 m	0100																															
1.5 m	0150																															
2.0 m	0200																															
Technical Data																																
Operating voltage	24 V DC ±25%																															
Protection	IP65, IP66K, IP67 inserted and tightened (EN 60529)																															
Temperature range	-25...+85 °C, depending on cable quality																															
Article No.																																
The composition of your article number is explained on page 3.1.i	<div style="display: flex; align-items: center; gap: 10px;"> <span style="border-bottom: 1px solid black; padding-bottom: 2px;">7</span> <span style="border-bottom: 1px solid black; padding-bottom: 2px;">0</span> <span style="border-bottom: 1px solid black; padding-bottom: 2px;">0</span> <span style="border-bottom: 1px solid black; padding-bottom: 2px;">0</span> <span style="font-size: 2em;">-</span> <span style="border-bottom: 1px solid black; padding-bottom: 2px;">_</span> <span style="border-bottom: 1px solid black; padding-bottom: 2px;">_</span> <span style="border-bottom: 1px solid black; padding-bottom: 2px;">_</span> <span style="border-bottom: 1px solid black; padding-bottom: 2px;">_</span> <span style="border-bottom: 1px solid black; padding-bottom: 2px;">_</span> <span style="border-bottom: 1px solid black; padding-bottom: 2px;">_</span> <span style="font-size: 2em;">-</span> <span style="border-bottom: 1px solid black; padding-bottom: 2px;">_</span> <span style="border-bottom: 1px solid black; padding-bottom: 2px;">_</span> <span style="border-bottom: 1px solid black; padding-bottom: 2px;">_</span> <span style="border-bottom: 1px solid black; padding-bottom: 2px;">_</span> </div> <div style="display: flex; align-items: center; gap: 10px; margin-top: 5px;"> <span style="border-bottom: 1px solid black; padding-bottom: 2px;">7</span> <span style="border-bottom: 1px solid black; padding-bottom: 2px;">0</span> <span style="border-bottom: 1px solid black; padding-bottom: 2px;">0</span> <span style="border-bottom: 1px solid black; padding-bottom: 2px;">5</span> <span style="font-size: 0.8em;">M12 Lite (plastic hexagonal screw) on request</span> </div>																															
	1 Form	2 Cable Type																														
		3 Cable Length																														
Notes																																
	Other versions on request. Differing cable lengths up to 2 m can be ordered in 0.2 m steps, from 2 m on in 0.5 m steps.																															



# M12 ROUND PLUG CONNECTORS

## Connection cables

– M12 - M12

### Male

straight

### Female

straight



Approvals:  

\* only for products with UL/CSA approved cable

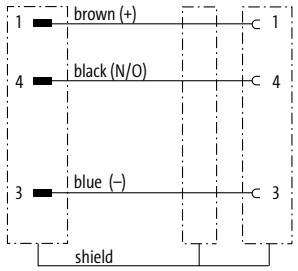
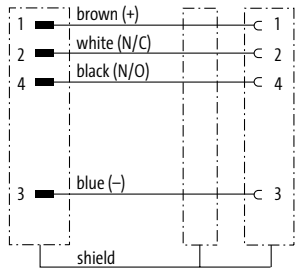
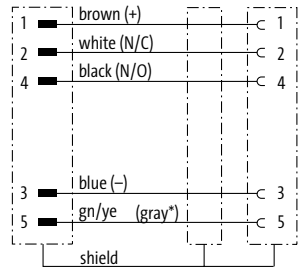
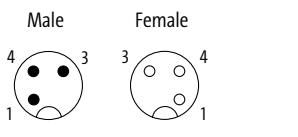
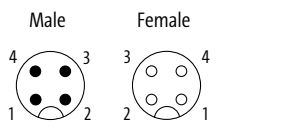
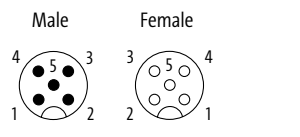
1 Form	40481	40501	40521
Type	3-pole, shielded	4-pole, shielded	5-pole, shielded
Circuit diagram			 <p>(* for cable type 203, 603, 243, 643)</p>
Contact layout			
Cable Type	Jacket Color	Jacket Color	Jacket Color
Wire diameter 0.34 mm <sup>2</sup>	gray black	gray black	gray black
PVC (UL/CSA)	200 600	201 601	202 (203) 602 (603)
PUR (UL/CSA), robots/Ctracks	240 640	241 641	242 (243) 642 (643)
Cable Length			
0.3 m	0030		
0.6 m	0060		
1.0 m	0100		
1.5 m	0150		
2.0 m	0200		
Technical Data			
Operating voltage	max. 60 V AC/DC		
Protection	IP65 and IP67 when plugged and screwed down (EN 60529)		
Temperature range	-25...+85 °C, depending on cable quality		
Article No.			
The composition of your article number is explained on page 3.1.i	<div style="display: flex; justify-content: space-around; align-items: center;"> <span style="border-bottom: 1px solid black; padding: 0 5px;">7</span> <span style="border-bottom: 1px solid black; padding: 0 5px;">0</span> <span style="border-bottom: 1px solid black; padding: 0 5px;">0</span> <span style="border-bottom: 1px solid black; padding: 0 5px;">0</span> <span style="font-size: 2em;">-</span> <span style="border-bottom: 1px solid black; padding: 0 5px;"> </span> <span style="font-size: 2em;">-</span> <span style="border-bottom: 1px solid black; padding: 0 5px;"> </span> <span style="border-bottom: 1px solid black; padding: 0 5px;"> </span> </div>		
	<b>1</b> Form	<b>2</b> Cable Type	<b>3</b> Cable Length
Notes	Other versions on request. Differing cable lengths up to 2 m can be ordered in 0.2 m steps, from 2 m on in 0.5 m steps.		

# M12 ROUND PLUG CONNECTORS

## Connection cables

– M12 - M12

### Male

straight

### Female

straight



\* only for products with UL/CSA approved cable

1 Form		48041	48041
Type	8-pole, shielded	8-pole, shielded	8-pole, shielded
Circuit diagram			
Contact layout			
2 Cable Type	Jacket Color		Jacket Color
Wire diameter 0.25 mm <sup>2</sup>		gray	black
PVC (UL/CSA)		204	205
PUR (UL/CSA), robots/Ctracks		291	717
3 Cable Length			
0.3 m	0030		
0.6 m	0060		
1.0 m	0100		
1.5 m	0150		
2.0 m	0200		
Technical Data			
Operating voltage	max. 30 V AC/DC		
Protection	IP65, IP66K, IP67 inserted and tightened (EN 60529)		
Temperature range	-25...+85 °C, depending on cable quality		
Article No.			
The composition of your article number is explained on page 3.1.i	<div style="display: flex; justify-content: space-around; align-items: center;"> <span style="border: 1px solid black; padding: 2px;">7</span> <span style="border: 1px solid black; padding: 2px;">0</span> <span style="border: 1px solid black; padding: 2px;">0</span> <span style="border: 1px solid black; padding: 2px;">0</span> <span style="font-size: 2em;">-</span> <span style="border: 1px solid black; padding: 2px;"> </span> <span style="font-size: 2em;">-</span> <span style="border: 1px solid black; padding: 2px;"> </span> <span style="border: 1px solid black; padding: 2px;"> </span> <span style="border: 1px solid black; padding: 2px;"> </span> </div>		
	<b>1</b> Form	<b>2</b> Cable Type	<b>3</b> Cable Length
Notes	Other versions on request. Differing cable lengths up to 2 m can be ordered in 0.2 m steps, from 2 m on in 0.5 m steps.		

M12 Round Plug Connectors

# M12 ROUND PLUG CONNECTORS

## Connection cables

– M12 - M12

### Male

straight

### Female

straight



Approvals: 

\* only for products with UL/CSA approved cable

## 1 Form 53301

Type 12-pole, shielded

Circuit diagram

1	■	brown	—	⊂	1
2	■	blue	—	⊂	2
3	■	white	—	⊂	3
4	■	green	—	⊂	4
5	■	pink	—	⊂	5
6	■	yellow	—	⊂	6
7	■	black	—	⊂	7
8	■	gray	—	⊂	8
9	■	red	—	⊂	9
10	■	violet	—	⊂	10
11	■	gray/pink	—	⊂	11
12	■	red/blue	—	⊂	12
					Shield

Contact layout

Male	Female
	

## 2 Cable Type Jacket Color

Wire diameter 0.14 mm <sup>2</sup>	black
PVC (UL/CSA)	703
PUR (UL/CSA), robots/Ctracks	706

## 3 Cable Length

0.3 m	0030
0.6 m	0060
1.0 m	0100
1.5 m	0150
2.0 m	0200

## Technical Data

Operating voltage	max. 30 V AC/DC
Protection	IP67 inserted and tightened (EN 60529)
Temperature range	-25...+85 °C, depending on cable quality

## Article No.

The composition of your article number is explained on page 3.1.i

<u>7</u> <u>0</u> <u>0</u> <u>0</u>	-	<u>5</u> <u>3</u> <u>3</u> <u>0</u> <u>1</u>	-	---	---
		<b>1</b> Form	<b>2</b> Cable Type		<b>3</b> Cable Length

## Notes

Other versions on request. Differing cable lengths up to 2 m can be ordered in 0.2 m steps, from 2 m on in 0.5 m steps.

# M12 ROUND PLUG CONNECTORS

Field-wireable

– IDC terminals

Male

straight



Female

straight



1 Form	12461 me×	12481 me×	12581 me×	12601 me×
Type	3-pole	4-pole	3-pole	4-pole
Circuit diagram				
Connection cross section	0.25...0.5 mm <sup>2</sup>			
Contact layout	Male 	Male 	Female 	Female 
<b>Technical Data</b>				
Operating voltage	max. 32 V AC/DC			
Operating current per contact	max. 4 A			
Connection cross section	0.25...0.5 mm <sup>2</sup> (conductor diameter min. 0.1 mm)			
Sealing range (cable Ø)	4...5.1 mm			
Wire isolation	PVC, PP, TPE			
Outer wire Ø	1.2...1.6 mm			
Locking of ports	Screw thread M12 × 1 mm (recommended torque 0.6 Nm) self-securing			
Protection	IP67 inserted and tightened (EN 60529)			
Reconnection (cable)	10			
Temperature range	-25...+85 °C			
<b>Article No.</b>				
The composition of your article number is explained on page 3.1.i	<p><u>7</u> <u>0</u> <u>0</u> <u>0</u> - <u>    </u> - <u>0</u> <u>0</u> <u>0</u>   <u>0</u> <u>0</u> <u>0</u> <u>0</u></p> <p><u>7</u> <u>0</u> <u>0</u> <u>5</u> M12 Lite (plastic hexagonal screw) on request</p>			
	<b>1 Form</b>			
<b>Notes</b>	Other versions on request.			

# M12 ROUND PLUG CONNECTORS

Field-wireable  
– IDC terminals

**Male**  
straight, compact



**Female**  
straight, compact



**1 Form** **12491** **me** **12611** **me**

Approvals: cURus  
Type: 4-pole

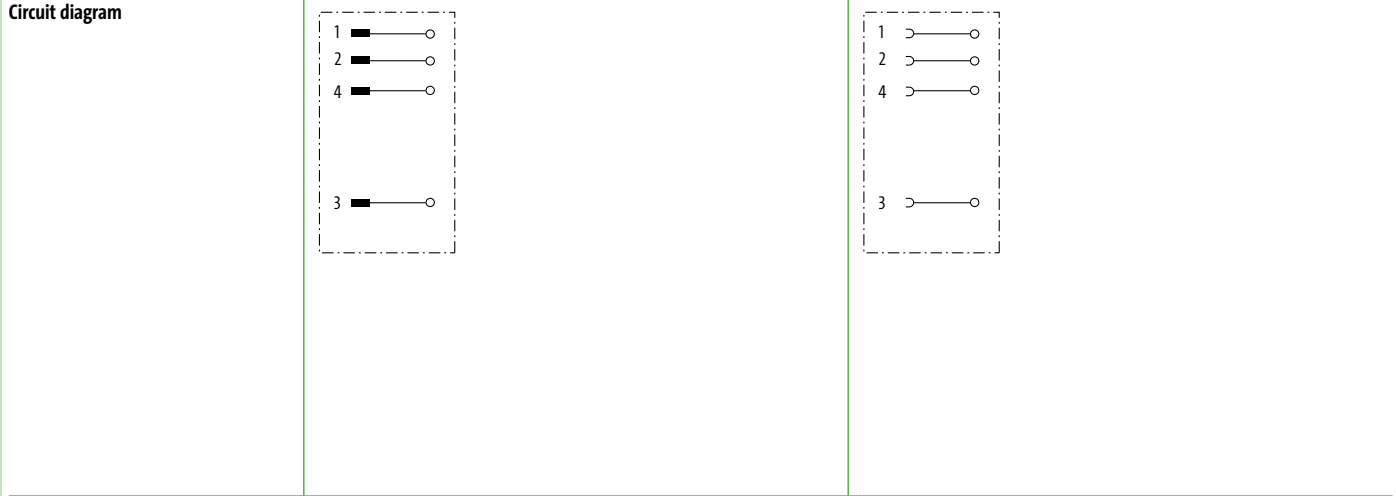

Connection cross section: 0.14...0.34 mm<sup>2</sup>

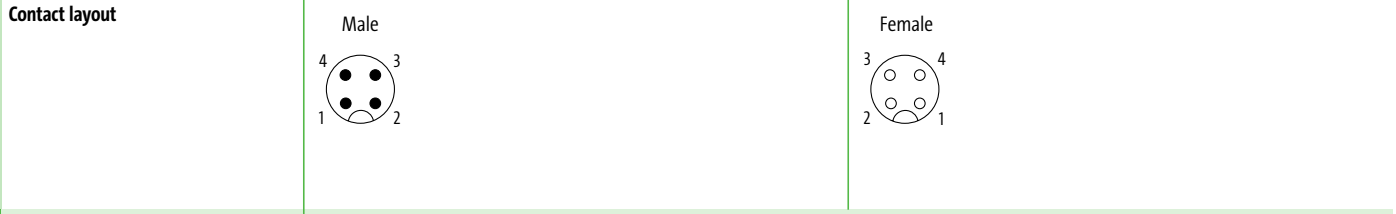

## Technical Data

Operating voltage	max. 32 V AC/DC
Operating current per contact	max. 4 A
Connection cross section	0.14...0.34 mm <sup>2</sup> (conductor diameter min. 0.1 mm)
Sealing range (cable Ø)	2.9...5.1 mm
Wire isolation	PVC, PP, TPE
Outer wire Ø	1.0...1.6 mm
Locking of ports	Screw thread M12 × 1 mm (recommended torque 0.6 Nm) self-securing
Protection	IP67 inserted and tightened (EN 60529)
Reconnection (cable)	10
Temperature range	-25...+85 °C

## Article No.

The composition of your article number is explained on page 3.1.i

7 0 0 0 - - - - - - 0 0 0 0 0 0 0

**1 Form**

Notes: Other versions on request.

# M12 ROUND PLUG CONNECTORS

Field-wireable

– IDC terminals

Male

90°



Female

90°



1 Form	12541 me×	12561 me×	12661 me×	12681 me×
Approvals		cURus		
Type	3-pole	4-pole	3-pole	4-pole
Circuit diagram				
Connection cross section	0.25...0.5 mm <sup>2</sup>			
Contact layout	<p>Male</p>	<p>Male</p>	<p>Female</p>	<p>Female</p>
<b>Technical Data</b>				
Operating voltage	max. 32 V AC/DC			
Operating current per contact	max. 4 A			
Connection cross section	0.25...0.5 mm <sup>2</sup> (conductor diameter min. 0.1 mm)			
Sealing range (cable Ø)	4...5.1 mm			
Wire isolation	PVC, PP, TPE			
Outer wire Ø	1.2...1.6 mm			
Locking of ports	Screw thread M12 × 1 mm (recommended torque 0.6 Nm) self-securing			
Protection	IP67 inserted and tightened (EN 60529)			
Reconnection (cable)	10			
Temperature range	-25...+85 °C			
<b>Article No.</b>				
The composition of your article number is explained on page 3.1.i	<p><u>7</u> <u>0</u> <u>0</u> <u>0</u> - <u>0</u> <u>0</u> <u>0</u>   <u>0</u> <u>0</u> <u>0</u> <u>0</u></p> <p><u>7</u> <u>0</u> <u>0</u> <u>5</u> M12 Lite (plastic hexagonal screw) on request</p>			
	<b>1 Form</b>			
<b>Notes</b>	Other versions on request.			

# M12 ROUND PLUG CONNECTORS

Field-wireable  
– IDC terminals

Female  
90° with LED



## 1 Form 12671 **me** 12691 **me**

Type	3-pole with 2 × LED (PNP)	4-pole with 3 × LED (PNP)
Circuit diagram		

Connection cross section	0.25...0.5 mm <sup>2</sup>	
Contact layout	<p>Female</p>	<p>Female</p>

Technical Data	
Operating voltage	24 V DC ±25%
Operating current per contact	max. 4 A
Connection cross section	0.25...0.5 mm <sup>2</sup> (conductor diameter min. 0.1 mm)
Sealing range (cable Ø)	4...5.1 mm
Wire isolation	PVC, PP, TPE
Outer wire Ø	1.2...1.6 mm
Locking of ports	Screw thread M12 × 1 mm (recommended torque 0.6 Nm) self-securing
Protection	IP67 inserted and tightened (EN 60529)
Reconnection (cable)	10
Temperature range	-25...+85 °C

## Article No.

The composition of your article number is explained on page 3.1.i	<u>7</u> <u>0</u> <u>0</u> <u>0</u> - - - - - - - - - - <u>0</u> <u>0</u> <u>0</u> <u>0</u>
	<u>7</u> <u>0</u> <u>0</u> <u>5</u> M12 Lite (plastic hexagonal screw) on request

**1** Form

Notes	Other versions on request.
-------	----------------------------

# M12 ROUND PLUG CONNECTORS

Field-wireable

– IDC terminals

Male

straight



1 Form	12501 me	12521 me	12515 me
Type	3-pole	4-pole	4-pole
Circuit diagram			
Connection cross section	0.5...1.0 mm <sup>2</sup>		
Contact layout	<p>Male</p>	<p>Male</p>	<p>Male</p>
<b>Technical Data</b>			
Operating voltage	max. 32 V AC/DC		
Operating current per contact	max. 4 A		
Connection cross section	0.5...1.0 mm <sup>2</sup> (conductor diameter min. 0.1 mm)		
Sealing range (cable Ø)	5.5...8 mm		
Wire isolation	PVC, PP, TPE		
Outer wire Ø	1.6...2.0 mm		
Locking of ports	Screw thread M12 × 1 mm (recommended torque 0.6 Nm) self-securing		
Protection	IP67 inserted and tightened (EN 60529)		
Reconnection (cable)	10		
Temperature range	-25...+85 °C		
<b>Article No.</b>			
The composition of your article number is explained on page 3.1.i	<p><u>7 0 0 0</u> - <u>    </u> - <u>0 0 0</u>   <u>0 0 0 0</u></p> <p><u>7 0 0 5</u> M12 Lite (plastic hexagonal screw) on request</p>		
	<b>1 Form</b>		
<b>Notes</b>	Other versions on request.		



# M12 ROUND PLUG CONNECTORS

Field-wireable  
– IDC terminals

Female  
straight



1 Form	12621 me	12641 me
--------	----------	----------

Type	3-pole	4-pole
Circuit diagram		

Connection cross section	0.5...1.0 mm <sup>2</sup>	
Contact layout	Female 	Female 

## Technical Data

Operating voltage	max. 32 V AC/DC
Operating current per contact	max. 4 A
Connection cross section	0.5...1.0 mm <sup>2</sup> (conductor diameter min. 0.1 mm)
Sealing range (cable Ø)	5.5...8 mm
Wire isolation	PVC, PP, TPE
Outer wire Ø	1.6...2.0 mm
Locking of ports	Screw thread M12 × 1 mm (recommended torque 0.6 Nm) self-securing
Protection	IP67 inserted and tightened (EN 60529)
Reconnection (cable)	10
Temperature range	-25...+85 °C

## Article No.

The composition of your article number is explained on page 3.1.i	<u>7</u> <u>0</u> <u>0</u> <u>0</u> - - - - - - - - - - <u>0</u> <u>0</u> <u>0</u> <u>0</u>
	<u>7</u> <u>0</u> <u>0</u> <u>5</u> M12 Lite (plastic hexagonal screw) on request

**1** Form

Notes	Other versions on request.
-------	----------------------------

# M12 ROUND PLUG CONNECTORS

Field-wireable

– Screw terminals

**Male**

straight



**Female**

straight



Approvals:

1 Form	12701 me×	12721 me×	12901 me×	12921 me×
Type	4-pole	5-pole	4-pole	5-pole
Circuit diagram				
Sealing range (cable Ø)	4...6 mm			
Contact layout	<p>Male</p>	<p>Male</p>	<p>Female</p>	<p>Female</p>
<b>Technical Data</b>				
Operating voltage	max. 250 V AC/DC	max. 60 V AC/DC	max. 250 V AC/DC	max. 60 V AC/DC
Operating current per contact	max. 4 A			
Connection cross section	max. 0.75 mm <sup>2</sup>			
Sealing range (cable Ø)	4...6 mm			
Locking of ports	Screw thread M12 × 1 mm (recommended torque 0.6 Nm) self-securing			
Protection	IP67 inserted and tightened (EN 60529)			
Temperature range	-40...+85 °C			
<b>Article No.</b>				
The composition of your article number is explained on page 3.1.i	<u>7</u> <u>0</u> <u>0</u> <u>0</u>	-	<u>0</u> <u>0</u> <u>0</u>	<u>0</u> <u>0</u> <u>0</u> <u>0</u>
	<b>1 Form</b>			
<b>Notes</b>	Other versions on request.			

# M12 ROUND PLUG CONNECTORS

Field-wireable  
– Screw terminals

Male  
straight

Female  
straight



Approvals:

M12 Round Plug Connectors

1 Form	12741 me <sup>x</sup>	12761 me <sup>x</sup>	12941 me <sup>x</sup>	12961 me <sup>x</sup>
Type	4-pole	5-pole	4-pole	5-pole
Circuit diagram				
Sealing range (cable Ø)	6...8 mm			
Contact layout	Male 	Male 	Female 	Female 
<b>Technical Data</b>				
Operating voltage	max. 250 V AC/DC	max. 60 V AC/DC	max. 250 V AC/DC	max. 60 V AC/DC
Operating current per contact	max. 4 A			
Connection cross section	max. 0.75 mm <sup>2</sup>			
Sealing range (cable Ø)	6...8 mm			
Locking of ports	Screw thread M12 × 1 mm (recommended torque 0.6 Nm) self-securing			
Protection	IP67 inserted and tightened (EN 60529)			
Temperature range	-40...+85 °C			
<b>Article No.</b>				
The composition of your article number is explained on page 3.1.i	<u>7</u> <u>0</u> <u>0</u> <u>0</u>	-	-	<u>0</u> <u>0</u> <u>0</u> <u>0</u>
	1 Form			
<b>Notes</b>	Other versions on request.			

# M12 ROUND PLUG CONNECTORS

Field-wireable

– Screw terminals

**Male**  
straight

**Female**  
straight

**Male**  
90°

**Female**  
90°



Approvals:

1 Form	17301 me $\times$	17321 me $\times$	17311 me $\times$	17331 me $\times$
Type	8-pole	8-pole	8-pole	8-pole
Circuit diagram				
Sealing range (cable $\varnothing$ )	6...8 mm			
Contact layout				
<b>Technical Data</b>				
Operating voltage	max. 30 V AC/DC			
Operating current per contact	max. 2 A			
Connection cross section	max. 0.5 mm <sup>2</sup>			
Sealing range (cable $\varnothing$ )	6...8 mm			
Locking of ports	Screw thread M12 $\times$ 1 mm (recommended torque 0.6 Nm) self-securing			
Protection	IP67 inserted and tightened (EN 60529)			
Temperature range	-40...+85 °C			
<b>Article No.</b>				
The composition of your article number is explained on page 3.1.i	<u>7</u> <u>0</u> <u>0</u> <u>0</u>	-	-	<u>0</u> <u>0</u> <u>0</u> <u>0</u>
	<b>1 Form</b>			
<b>Notes</b>	Other versions on request.			

# M12 ROUND PLUG CONNECTORS

Field-wireable  
– Screw terminals

Male  
90°



Female  
90°



Approvals:

M12 Round Plug Connectors

1 Form	12821 me $\times$	12841 me $\times$	12981 me $\times$	13001 me $\times$
Type	4-pole	5-pole	4-pole	5-pole
Circuit diagram				
Sealing range (cable $\varnothing$ )	4...6 mm			
Contact layout				
<b>Technical Data</b>				
Operating voltage	max. 250 V AC/DC	max. 60 V AC/DC	max. 250 V AC/DC	max. 60 V AC/DC
Operating current per contact	max. 4 A			
Connection cross section	max. 0.75 mm <sup>2</sup>			
Sealing range (cable $\varnothing$ )	4...6 mm			
Locking of ports	Screw thread M12 $\times$ 1 mm (recommended torque 0.6 Nm) self-securing			
Protection	IP67 inserted and tightened (EN 60529)			
Temperature range	-40...+85 °C			
<b>Article No.</b>				
The composition of your article number is explained on page 3.1.i	<u>7</u> <u>0</u> <u>0</u> <u>0</u>	-	-	<u>0</u> <u>0</u> <u>0</u> <u>0</u>
	<b>1</b> Form			
<b>Notes</b>	Other versions on request.			

# M12 ROUND PLUG CONNECTORS

Field-wireable

– Screw terminals

Male

90°



Female

90°



Approvals:

M12 Round Plug Connectors

1 Form	12861 me×	12881 me×	13021 me×	13041 me×
Type	4-pole	5-pole	4-pole	5-pole
Circuit diagram				
Sealing range (cable Ø)	6...8 mm			
Contact layout	Male 	Male 	Female 	Female 
<b>Technical Data</b>				
Operating voltage	max. 250 V AC/DC	max. 60 V AC/DC	max. 250 V AC/DC	max. 60 V AC/DC
Operating current per contact	max. 4 A			
Connection cross section	max. 0.75 mm <sup>2</sup>			
Sealing range (cable Ø)	6...8 mm			
Locking of ports	Screw thread M12 × 1 mm (recommended torque 0.6 Nm) self-securing			
Protection	IP67 inserted and tightened (EN 60529)			
Temperature range	-40...+85 °C			
<b>Article No.</b>				
The composition of your article number is explained on page 3.1.i	<u>7</u> <u>0</u> <u>0</u> <u>0</u>	-	<u>0</u> <u>0</u> <u>0</u>	<u>0</u> <u>0</u> <u>0</u> <u>0</u>
	<b>1 Form</b>			
<b>Notes</b>	Other versions on request.			

# M12 ROUND PLUG CONNECTORS

Field-wireable  
– Screw terminals

Male  
straight



Female  
straight



Male  
90°



Female  
90°



Approvals: UL US  
Listed

M12 Round Plug Connectors

1 Form	12731 meX	12931 meX	12851 meX	13011 meX
Type	5-pole	5-pole	5-pole	5-pole
Circuit diagram				
Sealing range (cable Ø)	2.5...8.0 mm			
Contact layout	Male 	Female 	Male 	Female 
Technical Data				
Operating voltage	max. 60 V AC/DC			
Operating current per contact	max. 7.5 A (+40 °C; 1.5 mm <sup>2</sup> )			
Connection cross section	max. 1.5 mm <sup>2</sup>			
Sealing range (cable Ø)	2.5...8.0 mm			
Locking of ports	Screw thread M12 × 1 mm (recommended torque 0.6 Nm)			
Protection	IP67 inserted and tightened (EN 60529)			
Temperature range	-30...+85 °C			
Article No.				
The composition of your article number is explained on page 3.1.i	7 0 0 0 - _____ - 0 0 0    0 0 0 0			
	<b>1</b> Form			
Notes	Other versions on request.			

# M12 ROUND PLUG CONNECTORS

Field-wireable

– Screw terminals

Y connector

Male straight



1 Form	12781	me $\times$	12801	me $\times$
Type	4-pole		5-pole	
Circuit diagram				
Sealing range (cable $\emptyset$ )	2.1...3/4...5 mm			
Contact layout	<p>Male</p>		<p>Male</p>	
<b>Technical Data</b>				
Operating voltage	max. 250 V AC/DC		max. 125 V AC/DC	
Operating current per contact	max. 4 A			
Connection cross section	max. 0.75 mm <sup>2</sup>			
Sealing range (cable $\emptyset$ )	2.1...3/4...5 mm (2 cable entries)			
Protection	IP67 inserted and tightened (EN 60529)			
Temperature range	-40...+85 °C			
<b>Article No.</b>				
The composition of your article number is explained on page 3.1.i	<span style="border-bottom: 1px solid black; padding: 0 5px;">7</span> <span style="border-bottom: 1px solid black; padding: 0 5px;">0</span> <span style="border-bottom: 1px solid black; padding: 0 5px;">0</span> <span style="border-bottom: 1px solid black; padding: 0 5px;">0</span> <span style="font-size: 1.5em; padding: 0 10px;">-</span> <span style="border-bottom: 1px solid black; padding: 0 5px;"> </span> <span style="border-bottom: 1px solid black; padding: 0 5px;"> </span> <span style="border-bottom: 1px solid black; padding: 0 5px;"> </span> <span style="border-bottom: 1px solid black; padding: 0 5px;"> </span> <span style="font-size: 1.5em; padding: 0 10px;">-</span> <span style="border-bottom: 1px solid black; padding: 0 5px;">0</span> <span style="border-bottom: 1px solid black; padding: 0 5px;">0</span> <span style="border-bottom: 1px solid black; padding: 0 5px;">0</span> <span style="padding: 0 10px;"> </span> <span style="border-bottom: 1px solid black; padding: 0 5px;">0</span> <span style="border-bottom: 1px solid black; padding: 0 5px;">0</span> <span style="border-bottom: 1px solid black; padding: 0 5px;">0</span> <span style="border-bottom: 1px solid black; padding: 0 5px;">0</span>			
	<b>1 Form</b>			
Notes	Other versions on request.			



# M12 ROUND PLUG CONNECTORS

Field-wireable  
– Screw terminals

Male  
straight



Female  
straight



1 Form	13301 me*	13321 me*	13381 me*	13401 me*
Approvals		cURus		cURus
Type	5-pole, shielded	5-pole, shielded	5-pole, shielded	5-pole, shielded
Circuit diagram				
Sealing range (cable Ø)	4...6 mm	6...8 mm	4...6 mm	6...8 mm
Contact layout	<p>Male</p>		<p>Female</p>	
<b>Technical Data</b>				
Operating voltage	max. 60 V AC/DC			
Operating current per contact	max. 4 A			
Connection cross section	max. 0.75 mm <sup>2</sup>			
Sealing range (cable Ø)	4...6 mm	6...8 mm	4...6 mm	6...8 mm
Protection	IP67 inserted and tightened (EN 60529)			
Housing	Brass, nickel plated			
Temperature range	-40...+85 °C			
<b>Article No.</b>				
The composition of your article number is explained on page 3.1.i	<u>7</u> <u>0</u> <u>0</u> <u>0</u>	-	-	<u>0</u> <u>0</u> <u>0</u> <u>0</u>
		<b>1</b>	Form	
<b>Notes</b>	Other versions on request.			

# M12 ROUND PLUG CONNECTORS

Field-wireable

– Screw terminals

**Male**  
straight

**Female**  
straight

**Male**  
90°

**Female**  
90°

Approvals:

1 Form	17341 me✘	17361 me✘	17351 me✘	17371 me✘
Type	8-pole, shielded	8-pole, shielded	8-pole, shielded	8-pole, shielded
Circuit diagram				
Sealing range (cable Ø)	6...8 mm			
Contact layout	Male 	Female 	Male 	Female 
<b>Technical Data</b>				
Operating voltage	max. 30 V AC/DC			
Operating current per contact	max. 2 A			
Connection cross section	max. 0.5 mm <sup>2</sup>			
Sealing range (cable Ø)	6...8 mm			
Protection	IP67 inserted and tightened (EN 60529)			
Housing	Brass, nickel plated			
Temperature range	-40...+85 °C			
<b>Article No.</b>				
The composition of your article number is explained on page 3.1.i	<div style="display: flex; justify-content: space-between; align-items: center;"> <span><u>7 0 0 0</u></span> <span>–</span> <span>_____</span> <span>–</span> <span><u>0 0 0</u></span> <span><u>0 0 0 0</u></span> </div>			
	<b>1 Form</b>			
<b>Notes</b>	Other versions on request.			

# M12 ROUND PLUG CONNECTORS

Field-wireable  
– Screw terminals

Male  
90°



Female  
90°



<b>1</b>	<b>Form</b>	<b>13341 me*</b>	<b>13361 me*</b>	<b>13421 me*</b>	<b>13441 me*</b>
----------	-------------	------------------	------------------	------------------	------------------

Approvals					cURus
Type	5-pole, shielded	5-pole, shielded		5-pole, shielded	5-pole, shielded

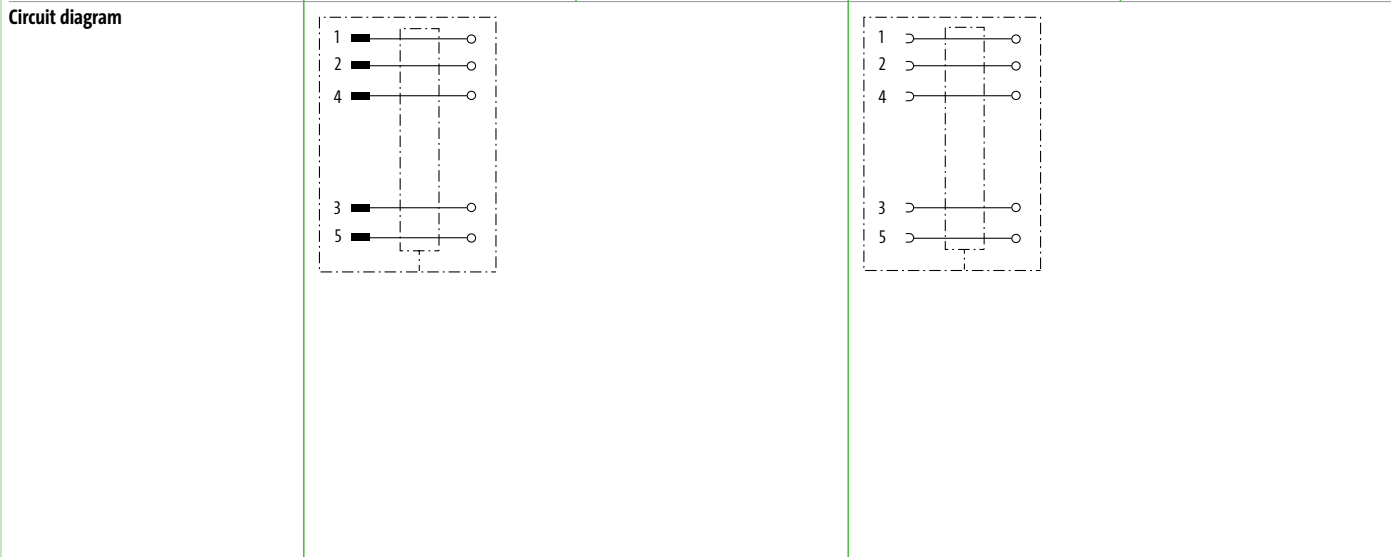

Sealing range (cable Ø)	4...6 mm	6...8 mm	4...6 mm	6...8 mm
-------------------------	----------	----------	----------	----------

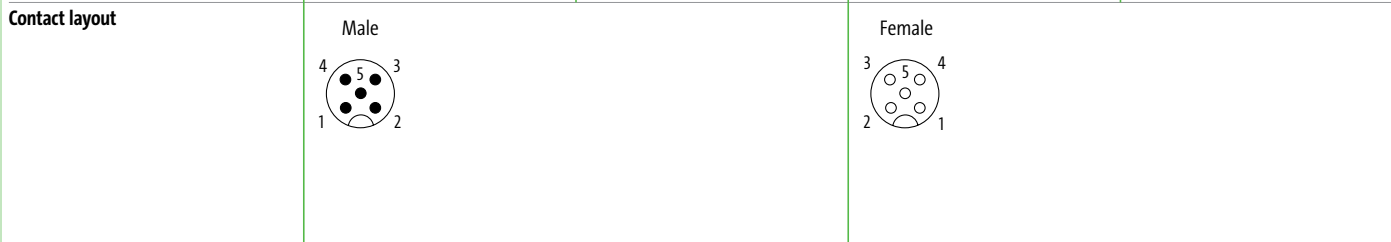

## Technical Data

Operating voltage	max. 60 V AC/DC			
Operating current per contact	max. 4 A			
Connection cross section	max. 0.75 mm <sup>2</sup>			
Sealing range (cable Ø)	4...6 mm	6...8 mm	4...6 mm	6...8 mm
Protection	IP67 inserted and tightened (EN 60529)			
Housing	Brass, nickel plated			
Temperature range	-40...+85 °C			

## Article No.

The composition of your article number is explained on page 3.1.i	<u>7</u> <u>0</u> <u>0</u> <u>0</u>	-	-	<u>0</u> <u>0</u> <u>0</u>	<u>0</u> <u>0</u> <u>0</u> <u>0</u>
---	-------------------------------------	---	---	----------------------------	-------------------------------------

**1** Form

Notes	Other versions on request.
-------	----------------------------

# M12 ROUND PLUG CONNECTORS

Labeling accessories			Art-No.
	<b>Slip-on cable sleeve</b> for ACS label plates (4 × 18 mm)	Cable diameter (4...6.5 mm)	7000-99004-0000000
	<b>Snap-on cable sleeve</b> for ACS label plates (4 × 18 mm)	Cable diameter (4.2...5.6 mm)	7000-99005-0000000
	for ACS label plates (4 × 18 mm)	Cable diameter (5...7 mm)	7000-99006-0000000
	<b>ACS label plate</b> for self marking (4 × 18 mm)		7000-99002-0000000
	<b>Colored ring M8/M12</b> sandy yellow	for unshielded molding	7000-99301-V011002
	zinc yellow	for unshielded molding	7000-99301-V011018
	redorange	for unshielded molding	7000-99301-V012008
	red	for unshielded molding	7000-99301-V013020
	violet	for unshielded molding	7000-99301-V014003
	purple	for unshielded molding	7000-99301-V014006
	blue	for unshielded molding	7000-99301-V015005
	green	for unshielded molding	7000-99301-V016018
	gray	for unshielded molding	7000-99301-V017035
	white	for unshielded molding	7000-99301-V019003
black	for unshielded molding	7000-99301-V019004	
Mounting accessories			Art-No.
	<b>Torque wrench set</b> M12 (0.6 Nm, SW13)	M12 data connenctor molded (standard)	7000-99102-0000000
	<b>Torque wrench</b> M12 (0.6 Nm, SW13)	M12 data connenctor molded (standard)	7000-99109-0000000
	<b>Torque wrench</b> M12 (0.6 Nm, SW17)	M12 field-wireable (IDC terminal)	7000-99094-0000000
	<b>Torque wrench</b> M12 (0.6 Nm, SW18)	M12 field-wireable via (screw terminals)	7000-99103-0000000
	<b>Hold clip M12</b> Plastic		7000-99045-0000000

## M12 ROUND PLUG CONNECTORS

End fitting accessories			Art-No.
	<b>Tube adapter</b> snap-in for corrugated tube (size 13mm)	Cable diameter (4...7 mm)	7000-99081-000000
Connection accessories			Art-No.
	<b>Universal holder</b> modular	M8 M12	7000-99801-000000
	<b>Universal holder</b> modular	M12 Y-connector M12	7000-99811-000000
	<b>Flange M12 male, pre-wired 0.2 m</b> straight, A-coded, 4-pole		7000-13501-9710020
	straight, A-coded, 5-pole	DeviceNet, CANopen	7000-13521-9720020
	straight, A-coded, 8-pole		7000-17161-9730020
	<b>Flange M12 female, pre-wired 0.2 m</b> straight, A-coded, 4-pole		7000-13541-9710020
	straight, A-coded, 5-pole	DeviceNet, CANopen	7000-13561-9720020
	straight, A-coded, 8-pole		7000-17181-9730020

# T-COUPLERS VERSATILE ADAPTERS

- Slimline saves space
- Minimizes wiring efforts
- Many different configurations

## T-COUPLERS FOR PERFECT SYSTEM INSTALLATIONS

Increasingly, automation requires a large number of sensors and with each sensor comes more wiring.

By using T-couplers you reduce the number of cables required and you can combine inputs and outputs depending on the application. Thanks to the slim design, you can connect several M12 ports to our Cube module. The handy torque wrench makes installation easy even in tight spaces and guarantees IP67 seals.

The slimline T-couplers feature a new female screw connection which makes the connection even safer and easier.

### T-couplers

	<p><b>M8 male</b> T-coupler T-coupler (Nano)</p>	<p><b>M8 female</b> T-coupler T-coupler (Nano)</p> <p style="text-align: right;"><i>Page 3.3.1</i></p>
	<p><b>M12 male</b> T-coupler</p>	<p><b>M12 female</b> T-coupler</p> <p style="text-align: right;"><i>Page 3.3.2</i></p>
	<p><b>M12 female</b> T-coupler • Industrial Ethernet</p>	<p><b>M12 male/M12 female</b> T-coupler</p> <p style="text-align: right;"><i>Page 3.3.4</i></p>
	<p><b>7/8" male</b> T-coupler</p>	<p><b>7/8" female</b> T-coupler</p> <p style="text-align: right;"><i>Page 3.3.5</i></p>

# T-COUPLERS M8, M12, 7/8"

M8 - M8

## T-coupler

Male straight - female straight



## T-coupler (Nano)

Male straight - female straight



1 Form	88611	88621	88602
Approvals	cULus	cULus	
Type	3-pole Parallel circuit	3-pole Series connection	3-/4-pole Distribution function (NO)
Circuit diagram			
Contact layout			
<b>Technical Data</b>			
Operating voltage	max. 50 V AC/60 V DC		max. 32 V AC/DC
Rated surge voltage	1.5 kV		0.8 kV
Operating current per contact	max. 4 A		max. 2 A
Locking of ports	Screw thread M8 x 1 mm (recommended torque 0.4 Nm) self-securing		Screw thread M8 x 1 mm, self-securing
Protection	IP67 inserted and tightened (EN 60529)		
Temperature range	-25...+85 °C		-30...+80 °C
<b>Article No.</b>			
The composition of your article number is explained on page 3.1.i	<div style="display: flex; justify-content: space-around; align-items: center;"> <span><u>7</u> <u>0</u> <u>0</u> <u>0</u></span> <span>-</span> <span>_____</span> <span>-</span> <span><u>0</u> <u>0</u> <u>0</u></span> <span><u>0</u> <u>0</u> <u>0</u> <u>0</u></span> </div>		
	<b>1 Form</b>		
Notes	Other versions on request.		

# T-COUPLERS M8, M12, 7/8"

M12 - M12

## T-coupler

Male straight - female straight



Approvals:  UL US Listed

T-couplers M8, M12, 7/8"

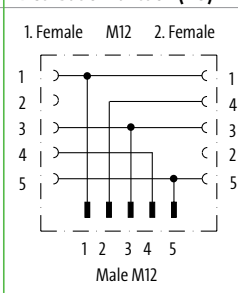
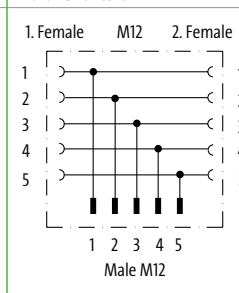
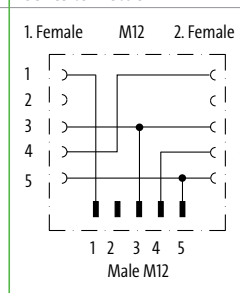
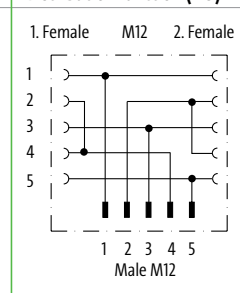
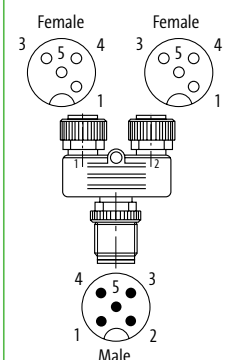
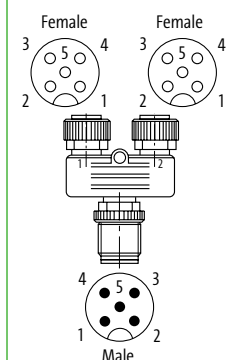
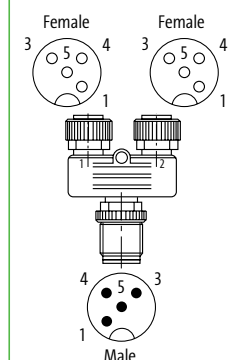
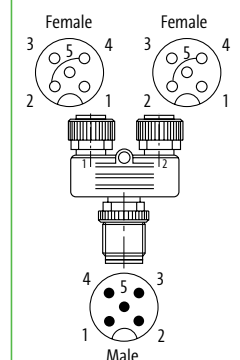
1 Form	41121	41141	41161	41181
Type	5-pole	5-pole	4-pole	5-pole
Distribution function (NO)		Parallel circuit	Series connection	Distribution function (NO)
Circuit diagram	<p>1. Female M12 2. Female</p>  <p>Male M12</p>	<p>1. Female M12 2. Female</p>  <p>Male M12</p>	<p>1. Female M12 2. Female</p>  <p>Male M12</p>	<p>1. Female M12 2. Female</p>  <p>Male M12</p>
Contact layout	 <p>Female Male</p>	 <p>Female Male</p>	 <p>Female Male</p>	 <p>Female Male</p>
<b>Technical Data</b>				
Operating voltage	max. 60 V AC/DC			
Operating voltage (only UL listed)	30 V AC/DC			
Rated surge voltage	1.5 kV			
Operating current per contact	max. 4 A			
Material group	IEC 60664-1, category I			
Locking of ports	Screw thread M12 x 1 mm (recommended torque 0.6 Nm) self-securing			
Protection	IP67 inserted and tightened (EN 60529)			
Locking material	Zinc die casting, matte nickel plated			
Temperature range	-25...+85 °C			
<b>Article No.</b>				
The composition of your article number is explained on page 3.1.i	<u>7</u> <u>0</u> <u>0</u> <u>0</u>	-	-	<u>0</u> <u>0</u> <u>0</u> <u>0</u>
	<b>1</b> Form			
<b>Notes</b>	Other versions on request.			



# T-COUPLERS M8, M12, 7/8"

M12 - M12

## T-coupler (Slim Line)

Male straight - female straight



## T-coupler (Slim Line)

Male straight - female straight with LED



Approvals: UL US Listed

1 Form	41131	41151	41191	41135
Type	5-pole	5-pole	5-pole	5-pole with 3 × LED (PNP)
Distribution function (NO)		Parallel circuit		
Circuit diagram	<p>1. Female M12 2. Female</p> <p>Male M12</p>	<p>1. Female M12 2. Female</p> <p>Male M12</p>	<p>1. Female M12 2. Female</p> <p>Male M12</p>	<p>1. Female M12 2. Female</p> <p>Male M12</p>
Contact layout				
<b>Technical Data</b>				
Operating voltage	max. 60 V AC/DC			24 V DC ±25%
Operating voltage (only UL listed)	30 V AC/DC			30 V DC
Rated surge voltage	1.5 kV			0.8 kV
Operating current per contact	max. 4 A			
Locking of ports	Screw thread M12 × 1 mm (recommended torque 0.6 Nm) self-securing			
Protection	IP67 inserted and tightened (EN 60529)			
Temperature range	-25...+85 °C			
<b>Article No.</b>				
The composition of your article number is explained on page 3.1.i	<u>7</u> <u>0</u> <u>0</u> <u>0</u>	-	-	<u>0</u> <u>0</u> <u>0</u> <u>0</u>
	<b>1</b> Form			
Notes	Other versions on request.			

T-couplers M8, M12, 7/8"

# T-COUPLERS M8, M12, 7/8"

Industrial Ethernet

– M12 - M12

## T-coupler

Female straight - male/female straight



## T-coupler

Female straight - female straight



### 1 Form

#### 47301

4-/8-pole, shielded

Y-coded, D-coded

Distribution function (NO)

#### Circuit diagram

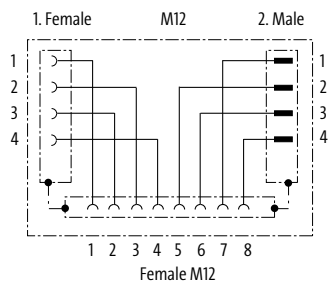

#### Contact layout

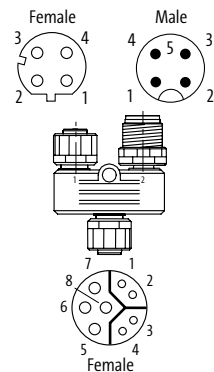

#### 47311

4-/8-pole, shielded

Y-coded, D-coded

Distribution function (NO)

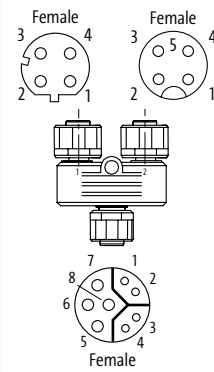
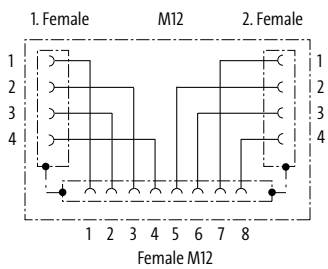

### Technical Data

Operating voltage	max. 30 V DC
Rated surge voltage	0.8 kV
Operating current per contact	4 A (Power), 0.5 A (Data)
Material group	IEC 60664-1, category I
Transfer parameters	CAT5, Class D (ISO/IEC 11801:2002), (EN 50173-1)
Transfer rate	to 100 Mbit/s Full Duplex
Locking of ports	Screw thread M12 × 1 mm (recommended torque 0.6 Nm) self-securing
Protection	IP54 inserted and tightened (EN 60529)
Locking material	Zinc die casting, matte nickel plated
Temperature range	-25...+85 °C

### Article No.

The composition of your article number is explained on page 3.1.i

7 0 0 0 - - - - - - - 0 0 0 0 0 0 0

**1** Form

### Notes

Other versions on request.

T-couplers M8, M12, 7/8"

# T-COUPLERS M8, M12, 7/8"

7/8" - 7/8"

**T-coupler**  
Female straight - male/female straight



**1 Form** **50061**

Type **5-pole**

Circuit diagram **Parallel circuit**

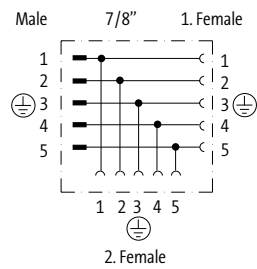

**Contact layout**

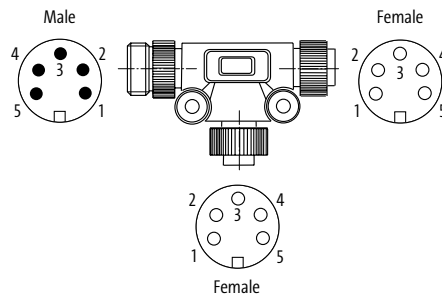

**Technical Data**

Operating voltage	max. 50 V AC/DC
Operating current per contact	max. 8 A
Protection	IP67 inserted and tightened (EN 60529)
Locking material	Zinc die casting
Temperature range	-20...+80 °C

**Article No.**

The composition of your article number is explained on page 3.1.i

7 0 0 0 - 5 0 0 6 1 - 0 0 0 0

**1 Form**

**Notes**

Other versions on request.

T-couplers M8, M12, 7/8"

## T-COUPPLERS M8, M12, 7/8"

Mounting accessories			Art-No.
	<b>Holding plate</b> for T-couplers M12 (SlimLine)	with mounting set	7000-99062-000000
	<b>Mounting clamp</b>		7000-99063-000000

T-couplers M8, M12, 7/8"



# FLANGE CONNECTORS READY FOR ANYTHING

- Molded PVC or PP wires
- Anti-twist protection ensures convenient assembly
- Front and rear mounting

## COMPREHENSIVE RANGE TO CUSTOMER NEEDS

Murrelektronik has a wide range of M12 flange plug connectors and offers solutions for all kinds of applications. Encapsulated components guarantee a high level of short-circuit protection. In addition, the integrated anti-rotation protection makes installation very easy.

Don't see what you needed? Visit [shop.murrelektronik.com](http://shop.murrelektronik.com) for other styles including V4A Stainless Steel for Food & Beverage applications.

### M8



- Male/female**
- 3-pole
  - 4-pole

Page 3.4.1

### M12



- Male/female**
- 3-pole
  - 4-pole
  - 5-pole
  - 8-pole

Page 3.4.2



- Control Cabinet Entry System  
Male/female (shielded)**
- 5-pole
  - 6-pole
  - 8-pole

Page 3.4.12

### Power

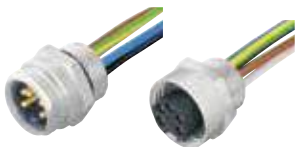

- 7/8"**  
**Male/female**
- 5-pole

Page 3.4.4



- M12 Power  
Male/female**
- 4-pole
  - 5-pole

Page 3.4.5



- MQ15 X-Power  
Male/female**
- 4-pole
  - 6-pole

Page 3.4.8



- MQ15 X-Power  
Male/female (shielded housing)**
- 4-pole
  - 6-pole

Page 3.4.10

# FLANGE CONNECTORS

With multi-strand wire

– M8

Approvals:

**Flange male**

Front mounting

**Flange female**

Front mounting



1 Form	08552	08562	08571	08581
Type	3-pole	4-pole	3-pole	4-pole
Circuit diagram				
Contact layout	Male 	Male 	Female 	Female 
<b>2 Wires</b>				
Wire diameter 0.25 mm <sup>2</sup>	multi-colored	multi-colored	multi-colored	multi-colored
PP	970	969	970	969
PVC	910	911	910	911
Hexagonal nut M8 × 0.5	7000-08591-0000000			
<b>3 Wires Length</b>				
0.2 m	0020			
0.5 m	0050			
1.0 m	0100			
<b>Technical Data</b>				
Operating voltage	max. 50 V AC/60 V DC			
Protection	IP67 inserted and tightened (EN 60529)			
Temperature range	-25...+85 °C			
<b>Article No.</b>				
The composition of your article number is explained on page 3.1.i	<div style="display: flex; justify-content: space-around; align-items: center;"> <span style="border-bottom: 1px solid black; padding: 0 5px;">7</span> <span style="border-bottom: 1px solid black; padding: 0 5px;">0</span> <span style="border-bottom: 1px solid black; padding: 0 5px;">0</span> <span style="border-bottom: 1px solid black; padding: 0 5px;">0</span> <span style="font-size: 2em;">-</span> <span style="border-bottom: 1px solid black; padding: 0 5px;"> </span> <span style="font-size: 2em;">-</span> <span style="border-bottom: 1px solid black; padding: 0 5px;"> </span> <span style="border-bottom: 1px solid black; padding: 0 5px;"> </span> <span style="border-bottom: 1px solid black; padding: 0 5px;"> </span> </div>			
	<b>1</b>	<b>2</b>	<b>3</b>	
	Form	Wires	Wires Length	
<b>Notes</b>	Other versions on request.			

# FLANGE CONNECTORS

With multi-strand wire

– M12



Flange male

Front mounting

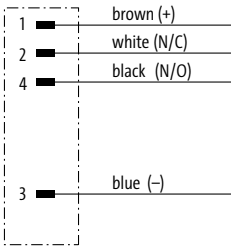
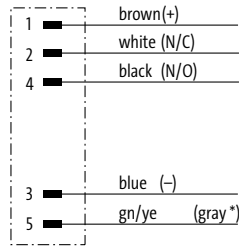
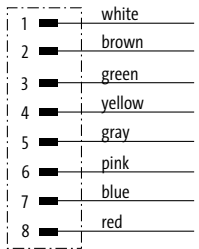

Approvals: 

Flange Connectors

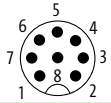
1 Form	13501	13521	17161
Type	4-pole	5-pole	8-pole
Circuit diagram		 <p>(* for cable type 902 and 972)</p>	
Contact layout	<p>Male</p> 	<p>Male</p> 	<p>Male</p> 
<b>2 Wires</b>			
Wire diameter 0.34 mm <sup>2</sup>	multi-colored	multi-colored	multi-colored
PUR		975 (972)	
PVC	901	902	
PP	971		
Wire diameter 0.25 mm <sup>2</sup>			
PP			973
PVC			903
Hexagonal nut M16 × 1.5	7000-13581-0000000		
<b>3 Wires Length</b>			
0.2 m	0020		
0.5 m	0050		
1.0 m	0100		
<b>Technical Data</b>			
Operating voltage	max. 250 V AC/DC	max. 125 V AC/DC	max. 30 V AC/DC
Protection	IP67 inserted and tightened (EN 60529)		
Temperature range	-25...+85 °C		
<b>Article No.</b>			
The composition of your article number is explained on page 3.1.i	<div style="display: flex; justify-content: space-around; align-items: center;"> <span style="border-bottom: 1px solid black; padding: 0 5px;">7</span> <span style="border-bottom: 1px solid black; padding: 0 5px;">0</span> <span style="border-bottom: 1px solid black; padding: 0 5px;">0</span> <span style="border-bottom: 1px solid black; padding: 0 5px;">0</span> <span style="font-size: 2em;">-</span> <span style="border-bottom: 1px solid black; padding: 0 5px;">-</span> <span style="border-bottom: 1px solid black; padding: 0 5px;">-</span> <span style="border-bottom: 1px solid black; padding: 0 5px;">-</span> <span style="border-bottom: 1px solid black; padding: 0 5px;">-</span> </div>		
	<b>1</b> Form	<b>2</b> Wires	<b>3</b> Wires Length
<b>Notes</b>	Other versions on request.		

# FLANGE CONNECTORS

With multi-strand wire

– M12

Flange female

Front mounting



Approvals:

1 Form	13541	13561	17181
Type	4-pole	5-pole	8-pole
Circuit diagram		<p>(* for cable type 902, 972)</p>	
Contact layout	<p>Female</p>	<p>Female</p>	<p>Female</p>
<b>2 Wires</b>			
Wire diameter 0.34 mm <sup>2</sup>	multi-colored	multi-colored	multi-colored
PUR		975 (972)	
PVC	901	902	
PP	971		
Wire diameter 0.25 mm <sup>2</sup>			
PP			973
PVC			903
<b>3 Wires Length</b>			
0.2 m	0020		
0.5 m	0050		
1.0 m	0100		
<b>Technical Data</b>			
Operating voltage	max. 250 V AC/DC	max. 125 V AC/DC	max. 30 V AC/DC
Protection	IP67 inserted and tightened (EN 60529)		
Temperature range	-25...+85 °C		
<b>Article No.</b>			
The composition of your article number is explained on page 3.1.i	<div style="display: flex; justify-content: space-around; align-items: center;"> <span style="border-bottom: 1px solid black; padding: 0 5px;">7</span> <span style="border-bottom: 1px solid black; padding: 0 5px;">0</span> <span style="border-bottom: 1px solid black; padding: 0 5px;">0</span> <span style="border-bottom: 1px solid black; padding: 0 5px;">0</span> <span style="font-size: 2em;">-</span> <span style="border-bottom: 1px solid black; padding: 0 5px;"> </span> <span style="font-size: 2em;">-</span> <span style="border-bottom: 1px solid black; padding: 0 5px;"> </span> <span style="border-bottom: 1px solid black; padding: 0 5px;"> </span> <span style="border-bottom: 1px solid black; padding: 0 5px;"> </span> </div>		
	<b>1</b> Form	<b>2</b> Wires	<b>3</b> Wires Length
Notes	Other versions on request.		

Flange Connectors



# FLANGE CONNECTORS

With multi-strand wire

- 7/8"

**Flange male**  
Front mounting



**Flange female**  
Front mounting



1 Form		78341	78381
Type		5-pole	5-pole
Circuit diagram			
Contact layout			
2 Wires			
5 x AWG18		multi-colored	multi-colored
PVC		978	978
Hexagonal nut PG 13.5		7000-78391-0000000	
3 Wires Length			
0.2 m		0020	
0.5 m		0050	
1.0 m		0100	
Technical Data			
Operating voltage		max. 300 V AC/DC	
Protection		IP68 inserted and tightened (EN 60529)	
Temperature range		-25...+85 °C	
Article No.			
The composition of your article number is explained on page 3.1.i		<div style="display: flex; align-items: center; gap: 10px;"> <span style="border-bottom: 1px solid black; padding: 0 5px;">7</span> <span style="border-bottom: 1px solid black; padding: 0 5px;">0</span> <span style="border-bottom: 1px solid black; padding: 0 5px;">0</span> <span style="border-bottom: 1px solid black; padding: 0 5px;">0</span> <span style="font-size: 2em;">-</span> <span style="border-bottom: 1px solid black; padding: 0 5px;"> </span> <span style="font-size: 2em;">-</span> <span style="border-bottom: 1px solid black; padding: 0 5px;"> </span> <span style="border-bottom: 1px solid black; padding: 0 5px;"> </span> </div>	<div style="border-bottom: 1px solid black; padding: 0 5px;"> </div>
		<b>1</b> Form	<b>2</b> Wires
			<b>3</b> Wires Length
Notes		Other versions on request.	

Flange Connectors

# FLANGE CONNECTORS

With multi-strand wire

– M12 Power

Approvals: 

## Flange male

Front mounting



## Flange female

Front mounting

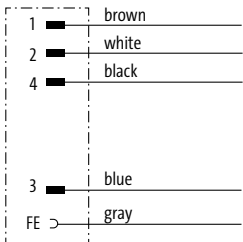
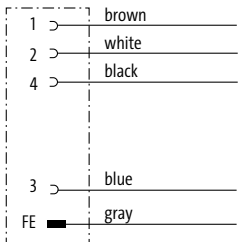
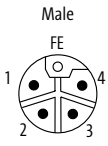
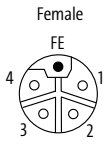

1 Form	P4281	P4291
Type	5-pole L-coded	5-pole L-coded
Circuit diagram		
Contact layout	<p>Male</p> 	<p>Female</p> 
2 Wires	<p>Wire diameter 1.5 mm<sup>2</sup> PUR</p> <p>multi-colored 980</p>	<p>multi-colored 980</p>
3 Wires Length	<p>0.2 m    <b>0020</b></p> <p>0.5 m    <b>0050</b></p> <p>1.0 m    <b>0100</b></p>	
Technical Data	<p>Operating voltage    max. 63 V AC/DC</p> <p>Protection    IP65 and IP67 when plugged and screwed down (EN 60529)</p> <p>Temperature range    -25...+85 °C, depending on cable quality</p>	
Article No.	<p>The composition of your article number is explained on page 3.1.i</p> <p><b>7 0 0 0</b> - - - - - - - - - -</p>	
	<b>1</b> Form	<b>2</b> Wires
		<b>3</b> Wires Length
Notes	Other versions on request.	

# FLANGE CONNECTORS

With multi-strand wire

– M12 Power

Approvals: 

**Flange male**

Front mounting



**Flange female**

Front mounting



## 1 Form

**P 6281**

**P 6291**

Type

4-pole

4-pole

Circuit diagram

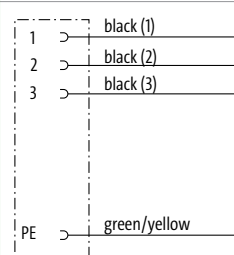
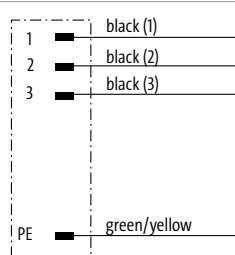

Contact layout

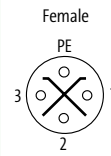
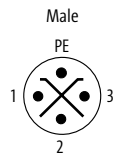

## 2 Wires

Wire diameter 1.5 mm<sup>2</sup>  
mPPE

multi-colored  
940

multi-colored  
940

## 3 Wires Length

0.2 m	<b>0020</b>
0.5 m	<b>0050</b>
1.0 m	<b>0100</b>
1.5 m	<b>0150</b>

## Technical Data

Operating voltage	max. 630 V AC/DC
Protection	IP67 inserted and tightened (EN 60529)
Temperature range	-40...+85 °C, depending on cable quality

## Article No.

The composition of your article number is explained on page 3.1.i

**7 0 0 0** - - - - -

**1** Form

**2** Wires

**3** Wires Length

Notes

Other versions on request.

# FLANGE CONNECTORS

With multi-strand wire

- M12 Power

**Flange male**

Front mounting



**Flange female**

Front mounting

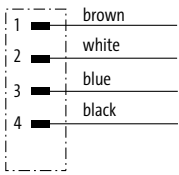
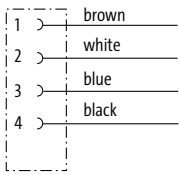
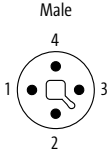
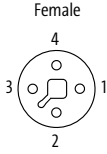

Approvals:  **us**

1 Form	P7281	P7291	
Type	4-pole T-coded	4-pole T-coded	
Circuit diagram			
Contact layout			
2 Wires			
Wire diameter 1.5 mm <sup>2</sup> PVC	multi-colored <b>941</b>	multi-colored <b>941</b>	
3 Wires Length			
0.2 m	<b>0020</b>		
0.5 m	<b>0050</b>		
1.0 m	<b>0100</b>		
Technical Data			
Operating voltage	max. 63 V AC/DC		
Protection	IP67 inserted and tightened (EN 60529)		
Temperature range	-40...+85 °C, depending on cable quality		
Article No.			
The composition of your article number is explained on page 3.1.i	<p style="text-align: center;"><b>7 0 0 0</b> - _____ - _____ - _____</p>		
	<b>1</b> Form	<b>2</b> Wires	<b>3</b> Wires Length
Notes	Other versions on request.		

# FLANGE CONNECTORS

With multi-strand wire

– MQ15 X-Power

Flange male

Front mounting



1 Form	P 8181	P 8081	P 8081
Type	6-pole max. 16 A (Power); max. 10 A (Signal)	4-pole Operating current: max. 13 A	4-pole Operating current: max. 16 A
Circuit diagram			
Contact layout			
2 Wires			
Wire diameter 2.5 mm <sup>2</sup>	multi-colored	multi-colored	multi-colored
PVC (UL)	P80		P82
Wire diameter 1.5 mm <sup>2</sup>			
PVC (UL)		P81	
3 Wires Length			
0.25 m	0025		
0.5 m	0050		
1.0 m	0100		
Technical Data			
Operating voltage	max. 600 V AC (Power); max. 63 V AC/DC (Signal)	max. 600 V AC	
Protection	IP67 inserted and tightened (EN 60529)		
Temperature range	-40...+70 °C, depending on cable quality		
Article No.			
The composition of your article number is explained on page 3.1.i	7 0 0 0	-	-
	<b>1</b> Form	<b>2</b> Wires	<b>3</b> Wires Length
Notes	Other versions on request.		

# FLANGE CONNECTORS

With multi-strand wire

– MQ15 X-Power

**Flange female**

Front mounting



1 Form	P8191	P8091
Type	6-pole max. 16 A (Power); max. 10 A (Signal)	4-pole Operating current: max. 13 A
Circuit diagram		
Contact layout		
2 Wires		
Wire diameter 2.5 mm <sup>2</sup> PVC (UL)	multi-colored P80	multi-colored
Wire diameter 1.5 mm <sup>2</sup> PVC (UL)		P81
3 Wires Length		
0.25 m	0025	
0.5 m	0050	
1.0 m	0100	
Technical Data		
Operating voltage	max. 600 V AC (Power); max. 63 V AC/DC (Signal)	max. 600 V AC
Protection	IP67 inserted and tightened (EN 60529)	
Temperature range	-40...+70 °C, depending on cable quality	-40...+90 °C, depending on cable quality
Article No.		
The composition of your article number is explained on page 3.1.i	<div style="display: flex; justify-content: space-around; align-items: center;"> <span style="border-bottom: 1px solid black; padding: 0 5px;">7</span> <span style="border-bottom: 1px solid black; padding: 0 5px;">0</span> <span style="border-bottom: 1px solid black; padding: 0 5px;">0</span> <span style="border-bottom: 1px solid black; padding: 0 5px;">0</span> <span style="font-size: 2em;">-</span> <span style="border-bottom: 1px solid black; padding: 0 5px;"> </span> <span style="font-size: 2em;">-</span> <span style="border-bottom: 1px solid black; padding: 0 5px;"> </span> <span style="border-bottom: 1px solid black; padding: 0 5px;"> </span> <span style="border-bottom: 1px solid black; padding: 0 5px;"> </span> </div>	
	<b>1</b> Form	<b>2</b> Wires
		<b>3</b> Wires Length
Notes	Other versions on request.	

Flange Connectors

# FLANGE CONNECTORS

With multi-strand wire

– MQ15 X-Power

– shielded housing

Flange male

Front mounting



1 Form	P 8381	P 8281	P 8281
Type	6-pole max. 16 A (Power); max. 10 A (Signal)	4-pole Operating current: max. 13 A	4-pole Operating current: max. 16 A
Circuit diagram			
Contact layout			
2 Wires			
Wire diameter 2.5 mm <sup>2</sup>	multi-colored	multi-colored	multi-colored
PVC (UL)	P80		P82
Wire diameter 1.5 mm <sup>2</sup>			
PVC (UL)		P81	
3 Wires Length			
0.25 m	0025		
0.5 m	0050		
1.0 m	0100		
Technical Data			
Operating voltage	max. 600 V AC (Power); max. 63 V AC/DC (Signal)	max. 600 V AC	
Protection	IP67 inserted and tightened (EN 60529)		
Temperature range	-40...+90 °C, depending on cable quality		
Article No.			
The composition of your article number is explained on page 3.1.i	7 0 0 0	-	-
	<b>1</b> Form	<b>2</b> Wires	<b>3</b> Wires Length
Notes	Other versions on request.		

Flange Connectors

# FLANGE CONNECTORS

With multi-strand wire

- MQ15 X-Power
- shielded housing

**Flange female**

Front mounting



1 Form	P 8391	P 8291	P 8291
Type	6-pole max. 16 A (Power); max. 10 A (Signal)	4-pole Operating current: max. 13 A	4-pole Operating current: max. 16 A
Circuit diagram			
Contact layout			
2 Wires			
Wire diameter 2.5 mm <sup>2</sup> PVC (UL)	multi-colored P80	multi-colored	multi-colored P82
Wire diameter 1.5 mm <sup>2</sup> PVC (UL)		P81	
3 Wires Length			
0.25 m	0025		
0.5 m	0050		
1.0 m	0100		
Technical Data			
Operating voltage	max. 600 V AC (Power); max. 63 V AC/DC (Signal)	max. 600 V AC	
Protection	IP67 inserted and tightened (EN 60529)		
Temperature range	-40...+90 °C, depending on cable quality		-40...+70 °C, depending on cable quality
Article No.			
The composition of your article number is explained on page 3.1.i	<div style="display: flex; justify-content: space-around; align-items: center;"> <span style="border-bottom: 1px solid black; padding: 0 5px;">7</span> <span style="border-bottom: 1px solid black; padding: 0 5px;">0</span> <span style="border-bottom: 1px solid black; padding: 0 5px;">0</span> <span style="border-bottom: 1px solid black; padding: 0 5px;">0</span> <span style="font-size: 2em;">-</span> <span style="border-bottom: 1px solid black; padding: 0 5px;"> </span> <span style="font-size: 2em;">-</span> <span style="border-bottom: 1px solid black; padding: 0 5px;"> </span> <span style="border-bottom: 1px solid black; padding: 0 5px;"> </span> <span style="border-bottom: 1px solid black; padding: 0 5px;"> </span> </div>		
	<b>1</b> Form	<b>2</b> Wires	<b>3</b> Wires Length
Notes	Other versions on request.		

Flange Connectors



# FLANGE CONNECTORS

Control cabinet entry system

– M12 - M12

Male/female



1 Form	42111	44111	46111	48111
Type	5-pole, shielded	5-pole, shielded B-coded	6-pole, shielded	8-pole, shielded
Circuit diagram				
Contact layout				
<b>Technical Data</b>	max. 60 V AC/DC		max. 30 V AC/DC	
Operating voltage	1.5 kV		0.8 kV	
Rated surge voltage	max. 4 A			max. 2 A
Operating current per contact	IEC 60664-1, category I			
Material group	A-coded	B-coded	A-coded	
Coding	Screw thread M12 × 1 mm (recommended torque 0.6 Nm) self-securing			
Locking of ports	IP65 and IP67 when plugged and screwed down (EN 60529)			
Protection	Brass, nickel plated			
Material	-25...+85 °C			
Temperature range	<p><b>Article No.</b></p> <p>The composition of your article number is explained on page 3.1.i</p> <p><u>7 0 0 0</u> - - - - - - - - - - <u>0 0 0</u> <u>0 0 0 0</u></p> <p><b>1 Form</b></p>			
Notes	Other versions on request.			

Flange Connectors

# FLANGE CONNECTORS

Control cabinet entry system

– M12 - M12

EtherCAT  EtherNet/IP

**PROFI**  
**NET**

Male/female







Female/female



1 Form	47281	44611	51521
Type	8-pole, shielded Y-coded	4-pole, shielded D-coded	8-pole, shielded X-coded
Circuit diagram			
Contact layout	<p>Male      Female</p>	<p>Female      Female</p>	<p>Female      Female</p>
<b>Technical Data</b>			
Operating voltage	max. 30 V DC	max. 60 V AC/DC	max. 50 V AC/60 V DC
Rated surge voltage	0.8 kV		
Operating current per contact	max. 6 A	max. 4 A	max. 0.5 A
Operating current per contact (Signal)	max. 0.5 A	–	–
Material group	IEC 60664-1, category I	–	IEC 60664-1, category III
Transfer parameters	CAT5, Class D (ISO/IEC 11801:2002), (EN 50173-1)		CAT6, Class EA (ISO/IEC 11801:2002), (EN 50173-1)
Transfer rate	to 100 Mbit/s Full Duplex		GIGABIT
Coding	Y-coded	D-coded	X-coded
Locking of ports	Screw thread M12 × 1 mm (recommended torque 0.6 Nm) self-securing		
Compression gland	M16 (SW19)		
Protection	IP65 and IP67 when plugged and screwed down (EN 60529)	IP67 inserted and tightened (EN 60529)	
Material	Brass, nickel plated		
Temperature range	-25...+85 °C		-40...+85 °C
<b>Article No.</b>			
The composition of your article number is explained on page 3.1.i	<u>7</u> <u>0</u> <u>0</u> <u>0</u>	–	<u>0</u> <u>0</u> <u>0</u>
			<u>0</u> <u>0</u> <u>0</u> <u>0</u>
	<b>1 Form</b>		
<b>Notes</b>	Other versions on request.		

Flange Connectors

## FLANGE CONNECTORS

Connection accessories			Art-No.
	<b>Shielding plate</b>	Quantity: 1 000 pcs.	<b>7000-99951-000000</b>
	<b>Protection cap</b> Flange M8 male	Quantity: 10 pcs.	<b>7000-99901-000000</b>
	Flange M12 male	Quantity: 10 pcs.	<b>7000-99921-000000</b>
	<b>Protection cap</b> Flange M8 female	Quantity: 10 pcs.	<b>7000-99911-000000</b>
			Flange M12 female Quantity: 10 pcs. <b>7000-99931-000000</b>

Flange Connectors

# THE MQ12 SYSTEM THE CLEVER SOLUTION

- Effective quick connection system
- Saves installation time – up to 80%
- Plug in, ¼ turn – done!

## COMPATIBLE, QUICK AND SAFE

**Simply clever** – it's our quick connection system that doesn't require any changes on the sensor side. MQ12 is completely compatible and interchangeable with all standard systems.

### More features:

- Fits on all existing sensor and distributor systems
- High resistance to shock and vibration
- IP67 sealed



Murrelektronik's Efficient  
Quick Connection System

## With Open Ended Wires

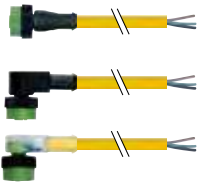

### MQ12 female

- Straight
- 90°
- 90° with LED

Page 3.5.1

## Connection Cables



### MQ12 male

- Straight

### MQ12 female

- Straight
- 90°
- 90° with LED

Page 3.5.3

## Field-Wireable



### Insulation Displacement Technology (IDC)

#### MQ12 male/female

- Straight

Page 3.5.5

# MQ12 ROUND PLUG CONNECTORS

With open ended wires

- M12

Female  
straight





Female  
90°

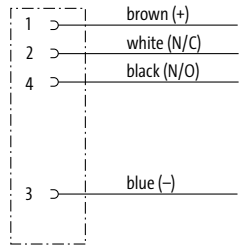

Approvals: 

\* only for products with UL/CSA approved cable

1 Form		12221			12341		
Type		4-pole			4-pole		
Circuit diagram							
Contact layout		Female 					
2 Cable Type		Jacket Color			Jacket Color		
Wire diameter 0.34 mm <sup>2</sup>		yellow	gray	black	yellow	gray	black
PVC (UL/CSA)		014	214	614	014	214	614
PUR/PVC (UL/CSA)		024	224	624	024	224	624
PUR (UL/CSA), robots/Ctracks		034	234	634	034	234	634
3 Cable Length							
1.5 m		0150					
3.0 m		0300					
5.0 m		0500					
7.5 m		0750					
10.0 m		1000					
Technical Data							
Operating voltage		max. 250 V AC/DC					
Protection		IP65 and IP67 when plugged and screwed down (EN 60529)					
Temperature range		-25...+85 °C, depending on cable quality					
Article No.							
The composition of your article number is explained on page 3.1.i		7 0 5 0			-		
		1 Form			2 Cable Type		3 Cable Length
Notes		Other versions on request. Differing cable lengths up to 2 m can be ordered in 0.2 m steps, from 2 m on in 0.5 m steps.					

# MQ12 ROUND PLUG CONNECTORS

With open ended wires

- M12

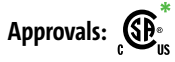

\* only for products with UL/CSA approved cable

**Female**  
90° with LED



## 1 Form 12421

Type **4-pole with 3 × LED (PNP)**  
(NPN) on request

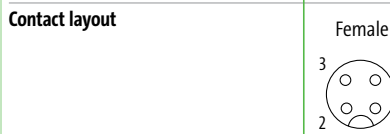
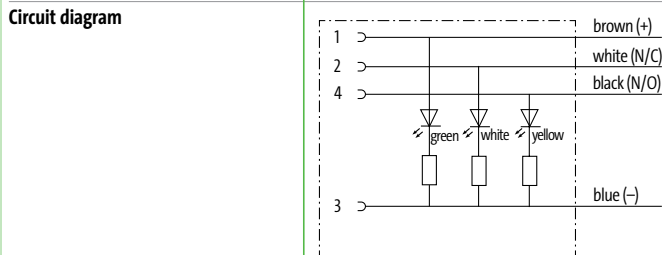

## 2 Cable Type Jacket Color

Wire diameter 0.34 mm <sup>2</sup>	yellow	gray	black
PVC (UL/CSA)	014	214	614
PUR/PVC (UL/CSA)	024	224	624
PUR (UL/CSA), robots/Ctracks	034	234	634

## 3 Cable Length

1.5 m	0150
3.0 m	0300
5.0 m	0500
7.5 m	0750
10.0 m	1000

## Technical Data

Operating voltage	24 V DC ±25%
Protection	IP65 and IP67 when plugged and screwed down (EN 60529)
Temperature range	-25...+85 °C, depending on cable quality

## Article No.

The composition of your article number is explained on page 3.1.i

7 0 5 0 - 1 2 4 2 1 - \_ \_ \_ \_

**1** Form **2** Cable Type **3** Cable Length

## Notes

Other versions on request. Differing cable lengths up to 2 m can be ordered in 0.2 m steps, from 2 m on in 0.5 m steps.

# MQ12 ROUND PLUG CONNECTORS

Connection cables

– M12 - M12

**Male**  
straight

**Female**  
straight

**Male**  
straight

**Female**  
90°



## 1 Form

**4 0 0 2 1**

**4 0 1 2 1**

Type

4-pole

4-pole

Circuit diagram

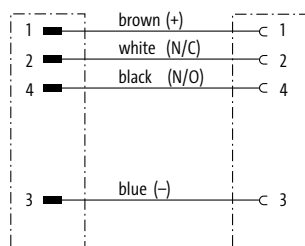

Contact layout

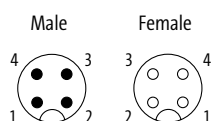

## 2 Cable Type

**Jacket Color**

**Jacket Color**

Wire diameter 0.34 mm<sup>2</sup>

**yellow**

gray

black

**yellow**

gray

black

PVC (UL/CSA)

**014**

214

614

**014**

214

614

PUR/PVC (UL/CSA)

**024**

224

624

**024**

224

624

PUR (UL/CSA), robots/Ctracks

**034**

234

634

**034**

234

634

## 3 Cable Length

0.3 m

**0030**

0.6 m

**0060**

1.0 m

**0100**

1.5 m

**0150**

2.0 m

**0200**

### Technical Data

Operating voltage

max. 250 V AC/DC

Protection

IP65 and IP67 when plugged and screwed down (EN 60529)

Temperature range

-25...+85 °C, depending on cable quality

### Article No.

The composition of your article number is explained on page 3.1.i

**7 0 5 0** - - - - -

**1** Form

**2** Cable Type

**3** Cable Length

Notes

Other versions on request. Differing cable lengths up to 2 m can be ordered in 0.2 m steps, from 2 m on in 0.5 m steps.

# MQ12 ROUND PLUG CONNECTORS

## Connection cables

– M12 - M12

### Male

straight

### Female

90° with LED



## 1 Form

**40341**

### Type

4-pole with 3 × LED (PNP)  
(NPN) on request

### Circuit diagram

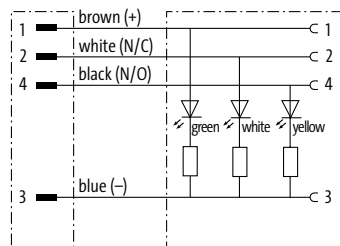

### Contact layout

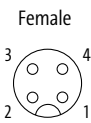
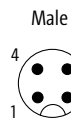

## 2 Cable Type

### Jacket Color

Wire diameter 0.34 mm <sup>2</sup>	yellow	gray	black
PVC (UL/CSA)	014	214	614
PUR/PVC (UL/CSA)	024	224	624
PUR (UL/CSA), robots/Ctracks	034	234	634

## 3 Cable Length

0.3 m	0030
0.6 m	0060
1.0 m	0100
1.5 m	0150
2.0 m	0200

### Technical Data

Operating voltage	24 V DC ±25%
Protection	IP65 and IP67 when plugged and screwed down (EN 60529)
Temperature range	-25...+85 °C, depending on cable quality

### Article No.

The composition of your article number is explained on page 3.1.i

7 0 5 0

-

4 0 3 4 1

-

\_\_\_\_

\_\_\_\_

**1**

Form

**2**

Cable Type

**3**

Cable Length

### Notes

Other versions on request. Differing cable lengths up to 2 m can be ordered in 0.2 m steps, from 2 m on in 0.5 m steps.



# MQ12 ROUND PLUG CONNECTORS

Field-wireable

– M12

– IDC terminals

**Male**

straight



**Female**

straight



1 Form	12461	12481	12581	12601								
Type	3-pole	4-pole	3-pole	4-pole								
Circuit diagram												
Connection cross section	0.25...0.5 mm <sup>2</sup>											
Contact layout	Male 	Male 	Female 	Female 								
<b>Technical Data</b>												
Operating voltage	max. 32 V AC/DC											
Rated surge voltage	0.8 kV											
Operating current per contact	max. 4 A											
Material group	IEC 60664-1, category II											
Connection cross section	0.25...0.5 mm <sup>2</sup> (conductor diameter min. 0.1 mm)											
Sealing range (cable Ø)	4...5.1 mm											
Wire isolation	PVC, PP, TPE											
Outer wire Ø	1.2...1.6 mm											
Protection	IP67 inserted and tightened (EN 60529)											
Temperature range	-25...+85 °C											
<b>Article No.</b>												
The composition of your article number is explained on page 3.1.i	<table border="1" style="width: 100%; text-align: center;"> <tr> <td style="width: 25%;"><u>7</u> <u>0</u> <u>5</u> <u>0</u></td> <td style="width: 25%;">-</td> <td style="width: 25%;">-</td> <td style="width: 25%;"><u>0</u> <u>0</u> <u>0</u></td> </tr> <tr> <td></td> <td></td> <td></td> <td><u>0</u> <u>0</u> <u>0</u> <u>0</u></td> </tr> </table>				<u>7</u> <u>0</u> <u>5</u> <u>0</u>	-	-	<u>0</u> <u>0</u> <u>0</u>				<u>0</u> <u>0</u> <u>0</u> <u>0</u>
<u>7</u> <u>0</u> <u>5</u> <u>0</u>	-	-	<u>0</u> <u>0</u> <u>0</u>									
			<u>0</u> <u>0</u> <u>0</u> <u>0</u>									
	<b>1 Form</b>											
<b>Notes</b>	Other versions on request.											

# MQ12 ROUND PLUG CONNECTORS

Field-wireable

– M12

– IDC terminals

**Male**  
straight



**Female**  
straight



## 1 Form

**12521**

**12641**

Type 4-pole 4-pole

Circuit diagram

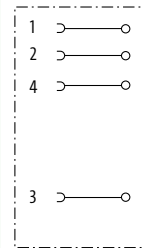
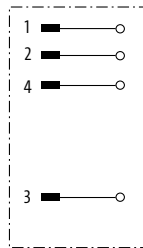

Connection cross section 0.5...1.0 mm<sup>2</sup>

Contact layout

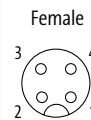
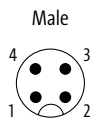

## Technical Data

Operating voltage	max. 250 V AC/DC
Rated surge voltage	2.5 kV
Operating current per contact	max. 4 A
Material group	IEC 60664-1, category III
Connection cross section	0.5...1.0 mm <sup>2</sup> (conductor diameter min. 0.1 mm)
Sealing range (cable Ø)	5.5...8 mm
Wire isolation	PVC, PP, TPE
Outer wire Ø	1.6...2.0 mm
Protection	IP67 inserted and tightened (EN 60529)
Temperature range	-25...+85 °C

## Article No.

The composition of your article number is explained on page 3.1.i

7 0 5 0

-

\_\_\_\_\_

0 0 0

0 0 0 0

**1** Form

Notes

Other versions on request.

# MQ12 ROUND PLUG CONNECTORS

Labeling accessories			Art-No.
	<b>Slip-on cable sleeve</b> for ACS label plates (4 × 18 mm)	Cable diameter (4...6.5 mm)	7000-99004-000000
	<b>Snap-on cable sleeve</b> for ACS label plates (4 × 18 mm)	Cable diameter (4.2...5.6 mm)	7000-99005-000000
	for ACS label plates (4 × 18 mm)	Cable diameter (5...7 mm)	7000-99006-000000
	<b>ACS label plate</b> for self marking (4 × 18 mm)		7000-99002-000000
	<b>Colored ring M8/M12</b>		
	sandy yellow	for unshielded molding	7000-99301-V011002
	zinc yellow	for unshielded molding	7000-99301-V011018
	redorange	for unshielded molding	7000-99301-V012008
	red	for unshielded molding	7000-99301-V013020
	violet	for unshielded molding	7000-99301-V014003
	purple	for unshielded molding	7000-99301-V014006
	blue	for unshielded molding	7000-99301-V015005
	green	for unshielded molding	7000-99301-V016018
	gray	for unshielded molding	7000-99301-V017035
white	for unshielded molding	7000-99301-V019003	
black	for unshielded molding	7000-99301-V019004	
End fitting accessories			Art-No.
	<b>Tube adapter</b> snap-in for corrugated tube (size 13mm)	Cable diameter (4...7 mm)	7000-99081-000000

MQ12 Round Plug Connectors



# CONNECTORS FOR FIELDBUS

- Wide range of M8, M12 and RJ45 connectors
- 360° shielding
- Flex rated cables

## FROM AS-INTERFACE TO ETHERNET TO PROFIBUS AND MORE...

**Murrelektronik offers connection accessories for the fieldbus products.** In addition to both field-wireable M12 and RJ45 connectors we have a wide range of pre-wired, molded models. Both the 15° locking mechanism and the PUR molding ensure an IP65/67 rated connection which make the connectors suitable for many rough industrial environments.



### PROFIBUS



With open ended wires

**M12 male/female (shielded)**  
• Straight/90°

Page 3.6.1

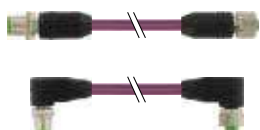

Connection Cables

**M12 male – M12 female (shielded)**  
• Straight/90°

Page 3.6.3

### DeviceNet, CANopen



With open ended wires

**M12 male/female**  
• Straight/90°

Page 3.6.4

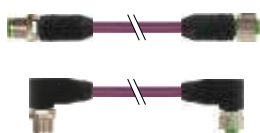

Connection Cables

**M12 male – M12 female**  
• Straight/90°

Page 3.6.6

## EtherNet, EtherCAT, PROFINET

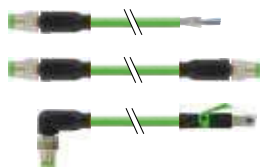

With open ended wires

**M8 male/female (shielded)**  
• Straight/90°

Connection Cables

**M8 male – M8 male/M8 female/RJ45 male (shielded)**  
• Straight/90°

Page 3.6.7



With open ended wires

**M8 female**  
• Straight/90°

Connection Cables

**M8 male – M8 female**  
• Straight/90°

Page 3.6.10

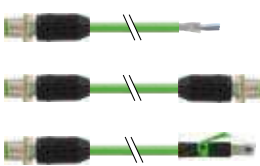

With open ended wires

**M12 male/female (shielded)**  
• Straight/90°

Connection Cables

**M12 male – M12 male/M12 female/RJ45 male (shielded)**  
• Straight/90°

Page 3.6.12

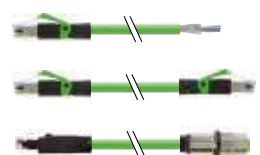

With open ended wires

**RJ45 male (shielded)**  
• Straight/90°

Connection Cables

**RJ45 male – RJ45 male/M12 female flange plug (shielded)**  
• Straight/90°

Page 3.6.21

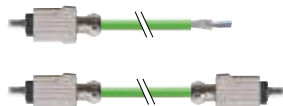

With open ended wires

**RJ45 male Push Pull Power**  
• Straight

Connection Cables

**RJ45 male Push Pull Power – RJ45 male Push Pull Power**  
• Straight

Page 3.6.26

## Cube67



With open ended wires

**M12 female**  
• Straight/90°

Page 3.6.28

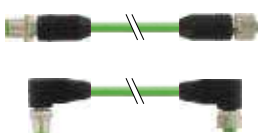

Connection Cables

**M12 male – M12 female (shielded)**  
• Straight/90°

Page 3.6.29

## AS-Interface

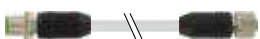

Connection Cables  
for MASI68

**M12 male – M12 female**  
• Straight

Page 3.6.30

# FIELD BUS CONNECTORS

## PROFIBUS

– with open ended wires M12



\* only for products with UL/CSA approved cable

### Male

straight



### Male

90°



<b>1 Form</b>	<b>14051</b>	<b>14081</b>
Type	2-pole, shielded B-coded	2-pole, shielded B-coded
Circuit diagram		
Contact layout	<p>Male</p>	
<b>2 Cable Type</b>	<b>Jacket Color</b>	<b>Jacket Color</b>
1x2x0.25 mm <sup>2</sup>	violet	violet
PUR (UL/CSA), C-tracks	841	841
PUR (UL/CSA), Highspeed C-track	840	840
PUR (UL/CSA), Torsion	843	843
PVC (UL), C-tracks	850	850
Terminator M12 (male)	7000-14041-0000000	
Control cabinet entry system M12	7000-44111-0000000	
<b>3 Cable Length</b>		
1.5 m	0150	
3.0 m	0300	
5.0 m	0500	
7.5 m	0750	
10.0 m	1000	
<b>Technical Data</b>		
Operating voltage	max. 60 V AC/DC	
Protection	IP65, IP66K, IP67 inserted and tightened (EN 60529)	
Temperature range	-25...+85 °C, depending on cable quality	
<b>Article No.</b>		
The composition of your article number is explained on page 3.1.i	<p><b>7 0 0 0</b> - - - - - - - - - -</p>	
	<b>1 Form</b>	<b>2 Cable Type</b>
		<b>3 Cable Length</b>
<b>Notes</b>	Other versions on request. Differing cable lengths up to 2 m can be ordered in 0.2 m steps, from 2 m on in 0.5 m steps. Connection accessories and general accessories can be found at the end of chapter 3.6.	

# FIELDBUS CONNECTORS

## PROFIBUS

– with open ended wires M12



\* only for products with UL/CSA approved cable

Female  
straight



Female  
90°

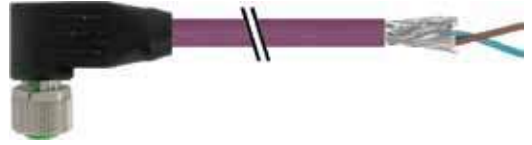

1 Form		14061	14071
Type		2-pole, shielded B-coded	2-pole, shielded B-coded
Circuit diagram			
Contact layout	Female 		
2 Cable Type		Jacket Color	Jacket Color
1x2x0.25 mm <sup>2</sup>		violet	violet
PUR (UL/CSA), C-tracks		841	841
PUR (UL/CSA), Highspeed C-track		840	840
PUR (UL/CSA), Torsion		843	843
PVC (UL), C-tracks		850	850
Terminator M12 (male)		7000-14041-0000000	
Control cabinet entry system M12		7000-44111-0000000	
3 Cable Length			
1.5 m		0150	
3.0 m		0300	
5.0 m		0500	
7.5 m		0750	
10.0 m		1000	
Technical Data			
Operating voltage		max. 60 V AC/DC	
Protection		IP65, IP66K, IP67 inserted and tightened (EN 60529)	
Temperature range		-25...+85 °C, depending on cable quality	
Article No.			
The composition of your article number is explained on page 3.1.i		7 0 0 0 - - - - -	- - - - -
		<b>1</b> Form	<b>2</b> Cable Type <b>3</b> Cable Length
Notes			
		Other versions on request. Differing cable lengths up to 2 m can be ordered in 0.2 m steps, from 2 m on in 0.5 m steps. Connection accessories and general accessories can be found at the end of chapter 3.6.	

# FIELD BUS CONNECTORS

## PROFIBUS

– Connection cables M12 - M12



\* only for products with UL/CSA approved cable

**Male**  
straight

**Female**  
straight

**Male**  
90°

**Female**  
90°



1 Form	44001	44021
--------	-------	-------

Type	2-pole, shielded B-coded	2-pole, shielded B-coded
------	-----------------------------	-----------------------------

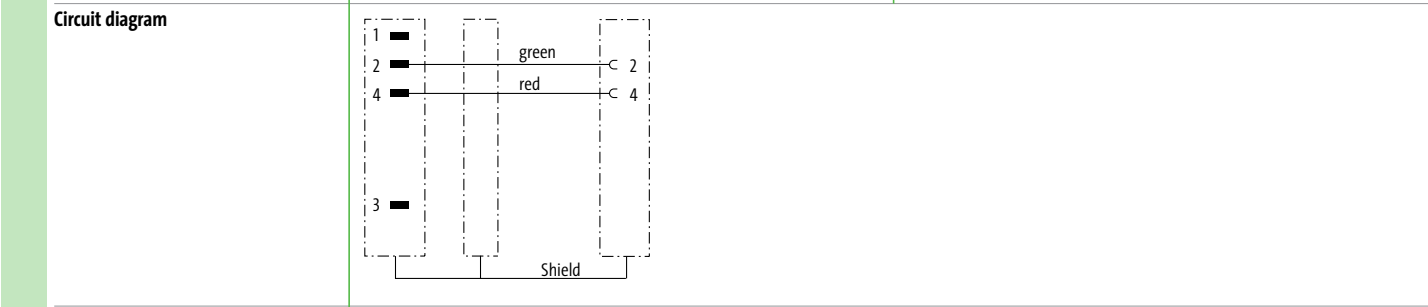

2 Cable Type	Jacket Color	Jacket Color
--------------	--------------	--------------

1x2x0.25 mm <sup>2</sup>	violet	violet
PUR (UL/CSA), C-tracks	841	841
PUR (UL/CSA), Highspeed C-track	840	840
PUR (UL/CSA), Torsion	843	843
PVC (UL), C-tracks	850	850

Terminator M12 (male)	7000-14041-0000000
Control cabinet entry system M12	7000-44111-0000000

3 Cable Length	
----------------	--

1.5 m	0150
3.0 m	0300
5.0 m	0500
7.5 m	0750
10.0 m	1000

Technical Data	
----------------	--

Operating voltage	max. 60 V AC/DC
Protection	IP65, IP66K, IP67 inserted and tightened (EN 60529)
Temperature range	-25...+85 °C, depending on cable quality

Article No.	
-------------	--

The composition of your article number is explained on page 3.1.i

<b>7 0 0 0</b>	-	-	-
----------------	---	---	---

<b>1</b> Form	<b>2</b> Cable Type	<b>3</b> Cable Length
---------------	---------------------	-----------------------

Notes	
-------	--

Other versions on request. Differing cable lengths up to 2 m can be ordered in 0.2 m steps, from 2 m on in 0.5 m steps.  
Connection accessories and general accessories can be found at the end of chapter 3.6.



# FIELDBUS CONNECTORS

DeviceNet, CANopen

– with open ended wires M12

DeviceNet CANopen



\* only for products with UL/CSA approved cable

Male

straight



Male

90°



<b>1 Form</b>	<b>13105</b>	<b>13125</b>										
	Type 5-pole	Type 5-pole										
Circuit diagram												
Contact layout	<p>Male</p>											
<b>2 Cable Type</b>	<b>Jacket Color</b>	<b>Jacket Color</b>										
2x0.25 + 2x0.34 mm <sup>2</sup> PUR (UL/CSA), C-tracks	<table border="1"> <tr> <td>black</td> <td>violet</td> </tr> <tr> <td>838</td> <td>803</td> </tr> </table>	black	violet	838	803	<table border="1"> <tr> <td>black</td> <td>violet</td> </tr> <tr> <td>838</td> <td>803</td> </tr> </table>	black	violet	838	803		
black	violet											
838	803											
black	violet											
838	803											
<b>3 Cable Length</b>												
1.5 m	<b>0150</b>											
3.0 m	<b>0300</b>											
5.0 m	<b>0500</b>											
7.5 m	<b>0750</b>											
10.0 m	<b>1000</b>											
<b>Technical Data</b>												
Operating voltage	max. 60 V AC/DC											
Protection	IP65, IP66K, IP67 inserted and tightened (EN 60529)											
Temperature range	-25...+85 °C, depending on cable quality											
<b>Article No.</b>												
The composition of your article number is explained on page 3.1.i	<table border="1"> <tr> <td><u>7</u></td> <td><u>0</u></td> <td><u>0</u></td> <td><u>0</u></td> <td>-</td> <td>---</td> <td>-</td> <td>---</td> <td>-</td> <td>---</td> </tr> </table>		<u>7</u>	<u>0</u>	<u>0</u>	<u>0</u>	-	---	-	---	-	---
<u>7</u>	<u>0</u>	<u>0</u>	<u>0</u>	-	---	-	---	-	---			
	<b>1 Form</b>	<b>2 Cable Type</b>	<b>3 Cable Length</b>									
<b>Notes</b>	Other versions on request. Differing cable lengths up to 2 m can be ordered in 0.2 m steps, from 2 m on in 0.5 m steps. Connection accessories and general accessories can be found at the end of chapter 3.6.											

# FIELDBUS CONNECTORS

DeviceNet, CANopen

– with open ended wires M12

DeviceNet **CANopen**



\* only for products with UL/CSA approved cable

Female

straight



Female

90°



1 Form		13225	13251			
Type	5-pole	5-pole	5-pole			
Circuit diagram						
Contact layout	<p>Female</p>					
2 Cable Type		Jacket Color		Jacket Color		
2x0.25 + 2x0.34 mm <sup>2</sup>		black	violet	black	violet	
PUR (UL/CSA), C-tracks		838	803	838	803	
Control cabinet entry system M12	7000-42111-0000000					
3 Cable Length						
1.5 m	0150					
3.0 m	0300					
5.0 m	0500					
7.5 m	0750					
10.0 m	1000					
Technical Data						
Operating voltage	max. 60 V AC/DC					
Protection	IP65, IP66K, IP67 inserted and tightened (EN 60529)					
Temperature range	-25...+85 °C, depending on cable quality					
Article No.						
The composition of your article number is explained on page 3.1.i	<div style="display: flex; justify-content: space-around; align-items: center;"> <span style="border-bottom: 1px solid black; padding: 0 10px;">7 0 0 0</span> <span>-</span> <span style="border-bottom: 1px solid black; padding: 0 10px;"> </span> <span>-</span> <span style="border-bottom: 1px solid black; padding: 0 10px;"> </span> <span style="border-bottom: 1px solid black; padding: 0 10px;"> </span> </div>					
	<b>1</b>	<b>Form</b>	<b>2</b>	<b>Cable Type</b>	<b>3</b>	<b>Cable Length</b>
Notes						
		Other versions on request. Differing cable lengths up to 2 m can be ordered in 0.2 m steps, from 2 m on in 0.5 m steps. Connection accessories and general accessories can be found at the end of chapter 3.6.				

# FIELDBUS CONNECTORS

DeviceNet, CANopen

– Connection cables M12 - M12

DeviceNet CANopen



\* only for products with UL/CSA approved cable

Male

straight

Female

straight



Male

90°

Female

90°



## 1 Form

40531

40551

Type 5-pole 5-pole

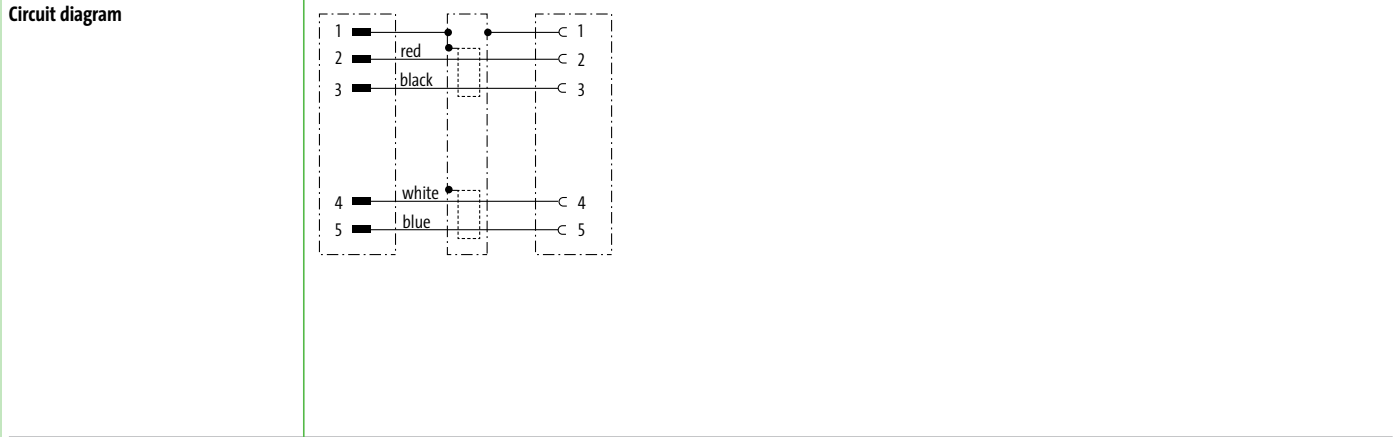

## 2 Cable Type

2x0.25 + 2x0.34 mm <sup>2</sup> PUR (UL/CSA), C-tracks	Jacket Color		Jacket Color	
	black	violet	black	violet
	838	803	838	803

Control cabinet entry system M12 7000-42111-0000000

## 3 Cable Length

1.5 m	0150
3.0 m	0300
5.0 m	0500
7.5 m	0750
10.0 m	1000

## Technical Data

Operating voltage	max. 60 V AC/DC
Protection	IP65, IP66K, IP67 inserted and tightened (EN 60529)
Temperature range	-25...+85 °C, depending on cable quality

## Article No.

The composition of your article number is explained on page 3.1.i

**7 0 0 0** - - - - -

**1** Form      **2** Cable Type      **3** Cable Length

## Notes

Other versions on request. Differing cable lengths up to 2 m can be ordered in 0.2 m steps, from 2 m on in 0.5 m steps. Connection accessories and general accessories can be found at the end of chapter 3.6.

Fieldbus Connectors

# FIELD BUS CONNECTORS

Industrial Ethernet

– with open ended wires M8

EtherCAT<sup>®</sup>



\* only for products with UL/CSA approved cable

**Male**  
straight



**Male**  
90°

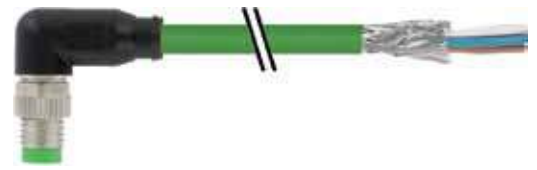

<b>1 Form</b>		<b>08811</b>	<b>08821</b>
Type	4-pole, shielded		4-pole, shielded
Circuit diagram			
Contact layout	<p>Male</p>		
<b>2 Cable Type</b>	<b>Jacket Color</b>	<b>Jacket Color</b>	
1x4x0.15 mm <sup>2</sup> PUR (UL/CSA), Ctracks	green 791	green 791	
<b>3 Cable Length</b>			
1.5 m	0150		
3.0 m	0300		
5.0 m	0500		
7.5 m	0750		
10.0 m	1000		
<b>Technical Data</b>			
Operating voltage	max. 30 V AC/DC		
Protection	IP67 inserted and tightened (EN 60529)		
Temperature range	-25...+85 °C, depending on cable quality		
<b>Article No.</b>			
The composition of your article number is explained on page 3.1.i	<p><b>7 0 0 0</b> - - - - - - - - - -</p>		
	<b>1 Form</b>	<b>2 Cable Type</b>	<b>3 Cable Length</b>
<b>Notes</b>	Other versions on request. Differing cable lengths up to 2 m can be ordered in 0.2 m steps, from 2 m on in 0.5 m steps. Connection accessories and general accessories can be found at the end of chapter 3.6.		

# FIELDBUS CONNECTORS

## Industrial Ethernet

– Connection cables M8 - M8

EtherCAT



\* only for products with UL/CSA approved cable

Male  
straight

Male  
straight

Male  
90°

Male  
90°



### 1 Form

**89701**

**89771**

Type  
Circuit diagram

4-pole, shielded

4-pole, shielded

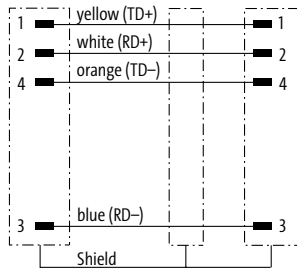

Contact layout

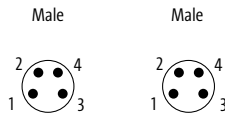

### 2 Cable Type

Jacket Color

Jacket Color

1x4x0.15 mm<sup>2</sup>  
PUR (UL/CSA), C-tracks

green  
791

green  
791

### 3 Cable Length

1.5 m	<b>0150</b>
3.0 m	<b>0300</b>
5.0 m	<b>0500</b>
7.5 m	<b>0750</b>
10.0 m	<b>1000</b>

### Technical Data

Operating voltage	max. 50 V AC/60 V DC
Protection	IP67 inserted and tightened (EN 60529)
Temperature range	-25...+85 °C, depending on cable quality

### Article No.

The composition of your article number is explained on page 3.1.i

**7 0 0 0** - - - - -

**1** Form

**2** Cable Type

**3** Cable Length

Notes

Other versions on request. Differing cable lengths up to 2 m can be ordered in 0.2 m steps, from 2 m on in 0.5 m steps. Connection accessories and general accessories can be found at the end of chapter 3.6.

# FIELDBUS CONNECTORS

Industrial Ethernet

– Connection cables M8 - RJ45

EtherCAT<sup>®</sup>

Approvals:  <sup>\*</sup>  
Listed

\* only for products with UL/CSA approved cable

Male

straight

Male

straight

Male

90°

Male

straight



## 1 Form

**89721**

**89781**

Type

4-pole, shielded

4-pole, shielded

Circuit diagram

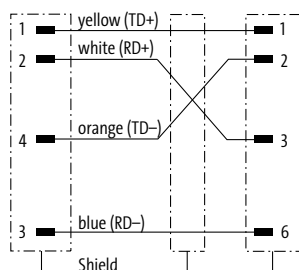

Contact layout

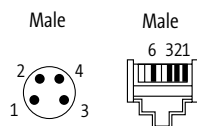

## 2 Cable Type

Jacket Color

Jacket Color

1x4x0.15 mm<sup>2</sup>

green

green

PUR (UL/CSA), C-tracks

791

791

## 3 Cable Length

1.5 m

0150

3.0 m

0300

5.0 m

0500

7.5 m

0750

10.0 m

1000

## Technical Data

Operating voltage

max. 60 V DC

Protection

IP67 (M8) - IP20 (RJ45)

Temperature range

-25...+85 °C, depending on cable quality

## Article No.

The composition of your article number is explained on page 3.1.i

**7 0 0 0** - - - - -

**1** Form

**2** Cable Type

**3** Cable Length

Notes

Other versions on request. Differing cable lengths up to 2 m can be ordered in 0.2 m steps, from 2 m on in 0.5 m steps.  
Connection accessories and general accessories can be found at the end of chapter 3.6.

# FIELDBUS CONNECTORS

## Industrial Ethernet

– with open ended wires M8

– EtherCAT Power

EtherCAT 

Approvals: 

\* only for products with UL/CSA approved cable

## Female

straight



## Female

90°



1 Form	08871	08881
--------	-------	-------

Type	4-pole	4-pole
------	--------	--------

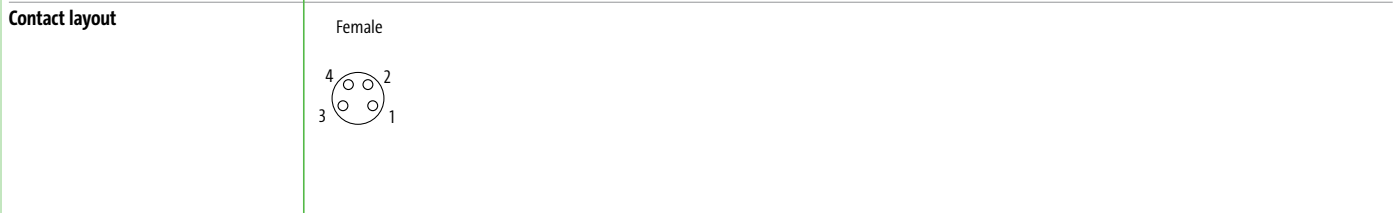
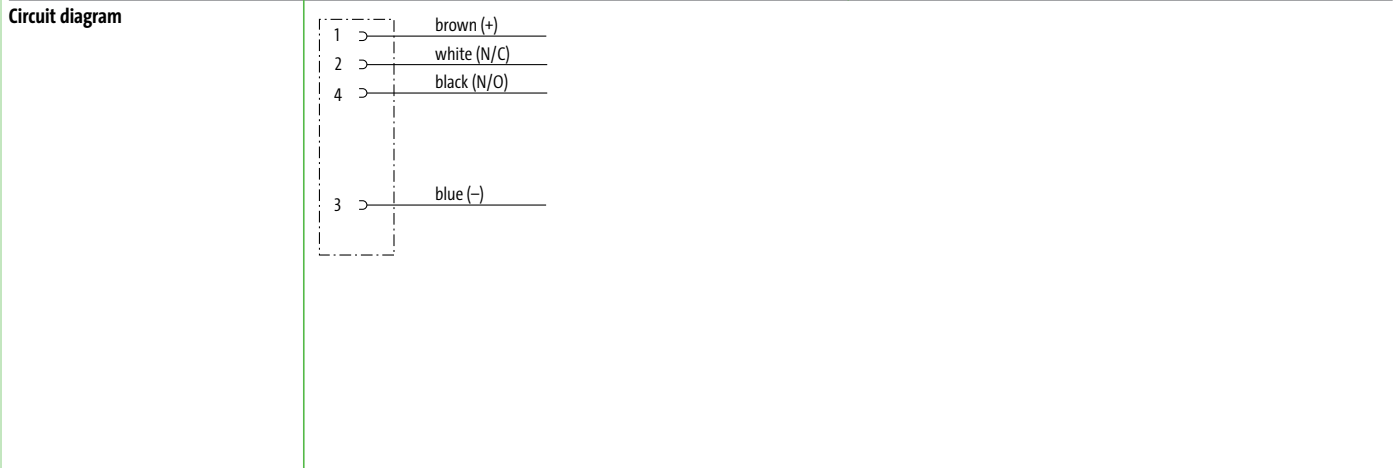

2 Cable Type	Jacket Color	Jacket Color
--------------	--------------	--------------

Wire diameter 0.34 mm <sup>2</sup> PUR (UL/CSA), robots/Ctracks	black 634	black 634
--	--------------	--------------

3 Cable Length	
----------------	--

1.5 m	0150
3.0 m	0300
5.0 m	0500
7.5 m	0750
10.0 m	1000

Technical Data	
----------------	--

Operating voltage	max. 50 V AC/60 V DC
Protection	IP65 and IP67 when plugged and screwed down (EN 60529)
Temperature range	-25...+85 °C, depending on cable quality

Article No.	
-------------	--

The composition of your article number is explained on page 3.1.i	<u>7</u> <u>0</u> <u>0</u> <u>0</u> - - - - - - - - - -
	<u>7</u> <u>0</u> <u>0</u> <u>5</u> M8 Lite (plastic hexagonal screw) on request

<b>1</b> Form	<b>2</b> Cable Type	<b>3</b> Cable Length
---------------	---------------------	-----------------------

Notes	
-------	--

Other versions on request. Differing cable lengths up to 2 m can be ordered in 0.2 m steps, from 2 m on in 0.5 m steps. Connection accessories and general accessories can be found at the end of chapter 3.6.

# FIELDBUS CONNECTORS

## Industrial Ethernet

– Connection cables M8 - M8

– EtherCAT Power

EtherCAT 

Approvals: 

\* only for products with UL/CSA approved cable

**Male**  
straight

**Female**  
straight

**Male**  
90°

**Female**  
90°



<b>1 Form</b>	<b>89401</b>	<b>89431</b>
Type	4-pole	4-pole
Circuit diagram		
Contact layout	<p>Male</p>	<p>Female</p>
<b>2 Cable Type</b>	<b>Jacket Color</b>	<b>Jacket Color</b>
Wire diameter 0.34 mm <sup>2</sup> PUR (UL/CSA), robots/C/tracks	<b>black</b> <b>634</b>	<b>black</b> <b>634</b>
<b>3 Cable Length</b>		
1.5 m	<b>0150</b>	
3.0 m	<b>0300</b>	
5.0 m	<b>0500</b>	
7.5 m	<b>0750</b>	
10.0 m	<b>1000</b>	
<b>Technical Data</b>		
Operating voltage	max. 50 V AC/60 V DC	
Protection	IP65 and IP67 when plugged and screwed down (EN 60529)	
Temperature range	-25...+85 °C, depending on cable quality	
<b>Article No.</b>		
The composition of your article number is explained on page 3.1.i	<p><b>7 0 0 0</b> - - - - - - - - - -</p> <p><b>7 0 0 5</b> M8 Lite (plastic hexagonal screw) on request</p>	
	<b>1 Form</b>	<b>2 Cable Type</b>
		<b>3 Cable Length</b>
<b>Notes</b>	Other versions on request. Differing cable lengths up to 2 m can be ordered in 0.2 m steps, from 2 m on in 0.5 m steps. Connection accessories and general accessories can be found at the end of chapter 3.6.	



# FIELDBUS CONNECTORS

## Industrial Ethernet

– with open ended wires M12

EtherNet/IP EtherCAT

PROFINET

Approvals:  

\* only for products with UL/CSA approved cable

## Male

straight



## Male

90°

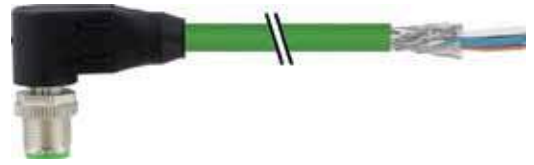

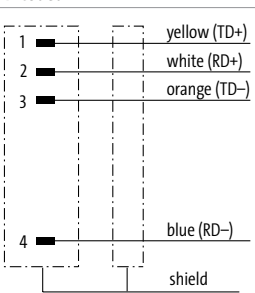
<b>1 Form</b>	<b>Form</b>	<b>14541</b>	<b>14561</b>	
	Type	4-pole, shielded D-coded	4-pole, shielded D-coded	
Circuit diagram				
	Contact layout			
<b>2 Cable Type</b>	<b>Cable Type</b>	<b>Jacket Color</b>		
	1x4x0.34 mm <sup>2</sup>	green	black	red
	PVC (UL/CSA), C-tracks	800		
	PUR (UL/CSA), Torsion	793		
	2x2x0.34 mm <sup>2</sup>			
	PUR (UL/CSA)	794		
PUR (UL/CSA), robots/C-tracks	796	851	792	
PUR (UL/CSA), C-tracks, 600 V	659			
<b>3 Cable Length</b>	1.5 m	0150		
	3.0 m	0300		
	5.0 m	0500		
	7.5 m	0750		
	10.0 m	1000		
	<b>Technical Data</b>			
Operating voltage	max. 60 V DC			
Protection	IP65, IP66K, IP67 inserted and tightened (EN 60529)			
Temperature range	-25...+85 °C, depending on cable quality			
<b>Article No.</b>				
The composition of your article number is explained on page 3.1.i	<div style="display: flex; justify-content: space-around; align-items: center;"> <span style="border-bottom: 1px solid black; padding: 0 5px;">7</span> <span style="border-bottom: 1px solid black; padding: 0 5px;">0</span> <span style="border-bottom: 1px solid black; padding: 0 5px;">0</span> <span style="border-bottom: 1px solid black; padding: 0 5px;">0</span> <span style="font-size: 2em;">-</span> <span style="border-bottom: 1px solid black; padding: 0 5px;"> </span> <span style="font-size: 2em;">-</span> <span style="border-bottom: 1px solid black; padding: 0 5px;"> </span> <span style="border-bottom: 1px solid black; padding: 0 5px;"> </span> </div>			
	<b>1 Form</b>	<b>2 Cable Type</b>	<b>3 Cable Length</b>	
<b>Notes</b>	Other versions on request. Differing cable lengths up to 2 m can be ordered in 0.2 m steps, from 2 m on in 0.5 m steps. Connection accessories and general accessories can be found at the end of chapter 3.6.			

# FIELDBUS CONNECTORS

## Industrial Ethernet

– with open ended wires M12

– Hybrid cable

### Male

straight



### Female

straight



Approvals: 

\* only for products with UL/CSA approved cable

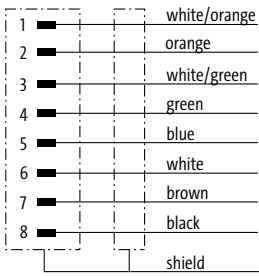
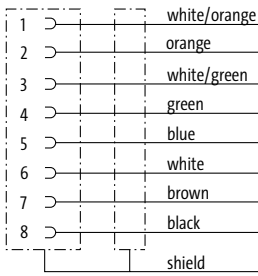
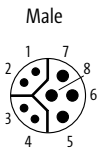
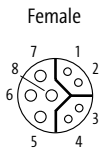
1 Form		15501	15551								
Type		8-pole, shielded Y-coded	8-pole, shielded Y-coded								
Circuit diagram											
Contact layout		<p>Male</p> 	<p>Female</p> 								
2 Cable Type		Jacket Color									
4×0.5 + 1×4×0.14 mm <sup>2</sup> PUR (UL/CSA), robots/C/tracks		<table border="1"> <tr> <td>black</td> <td>green</td> </tr> <tr> <td>805</td> <td>831</td> </tr> </table>	black	green	805	831	<table border="1"> <tr> <td>black</td> <td>green</td> </tr> <tr> <td>805</td> <td>831</td> </tr> </table>	black	green	805	831
black	green										
805	831										
black	green										
805	831										
3 Cable Length											
1.5 m		0150									
3.0 m		0300									
5.0 m		0500									
7.5 m		0750									
10.0 m		1000									
Technical Data											
Operating voltage		max. 50 V AC/DC									
Protection		IP65 and IP67 when plugged and screwed down (EN 60529)									
Temperature range		-25...+85 °C, depending on cable quality									
Article No.											
The composition of your article number is explained on page 3.1.i		<table border="1"> <tr> <td><u>7</u></td> <td><u>0</u></td> <td><u>0</u></td> <td><u>0</u></td> <td>-</td> <td>-</td> <td>-</td> <td>-</td> </tr> </table>		<u>7</u>	<u>0</u>	<u>0</u>	<u>0</u>	-	-	-	-
<u>7</u>	<u>0</u>	<u>0</u>	<u>0</u>	-	-	-	-				
		<b>1</b> Form	<b>2</b> Cable Type	<b>3</b> Cable Length							
Notes		Other versions on request. Differing cable lengths up to 2 m can be ordered in 0.2 m steps, from 2 m on in 0.5 m steps. Connection accessories and general accessories can be found at the end of chapter 3.6.									

# FIELDBUS CONNECTORS

## Industrial Ethernet

- with open ended wires M12
- Hybrid cable

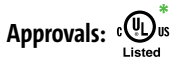

\* only for products with UL/CSA approved cable

Male  
90°

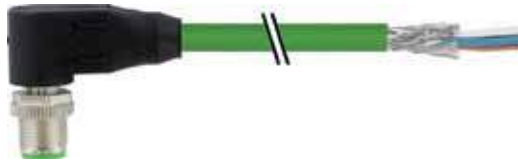

Female  
90°

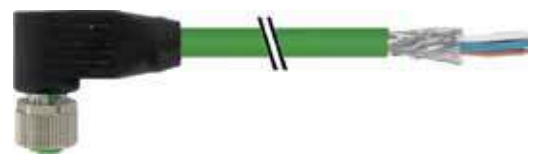

1 Form	15521	15571										
Type	8-pole, shielded Y-coded	8-pole, shielded Y-coded										
Circuit diagram												
Contact layout	<p>Male</p>	<p>Female</p>										
2 Cable Type	<p>Jacket Color</p> <table border="1"> <tr> <td>black</td> <td>green</td> </tr> <tr> <td>805</td> <td>831</td> </tr> </table>	black	green	805	831	<p>Jacket Color</p> <table border="1"> <tr> <td>black</td> <td>green</td> </tr> <tr> <td>805</td> <td>831</td> </tr> </table>	black	green	805	831		
black	green											
805	831											
black	green											
805	831											
3 Cable Length	<table border="1"> <tr> <td>1.5 m</td> <td>0150</td> </tr> <tr> <td>3.0 m</td> <td>0300</td> </tr> <tr> <td>5.0 m</td> <td>0500</td> </tr> <tr> <td>7.5 m</td> <td>0750</td> </tr> <tr> <td>10.0 m</td> <td>1000</td> </tr> </table>		1.5 m	0150	3.0 m	0300	5.0 m	0500	7.5 m	0750	10.0 m	1000
1.5 m	0150											
3.0 m	0300											
5.0 m	0500											
7.5 m	0750											
10.0 m	1000											
Technical Data	<table border="1"> <tr> <td>Operating voltage</td> <td>max. 50 V AC/DC</td> </tr> <tr> <td>Protection</td> <td>IP65 and IP67 when plugged and screwed down (EN 60529)</td> </tr> <tr> <td>Temperature range</td> <td>-25...+85 °C, depending on cable quality</td> </tr> </table>		Operating voltage	max. 50 V AC/DC	Protection	IP65 and IP67 when plugged and screwed down (EN 60529)	Temperature range	-25...+85 °C, depending on cable quality				
Operating voltage	max. 50 V AC/DC											
Protection	IP65 and IP67 when plugged and screwed down (EN 60529)											
Temperature range	-25...+85 °C, depending on cable quality											
Article No.	<p>The composition of your article number is explained on page 3.1.i</p> <p><b>7 0 0 0</b> - - - - -</p>											
	<b>1</b> Form	<b>2</b> Cable Type										
		<b>3</b> Cable Length										
Notes	<p>Other versions on request. Differing cable lengths up to 2 m can be ordered in 0.2 m steps, from 2 m on in 0.5 m steps. Connection accessories and general accessories can be found at the end of chapter 3.6.</p>											

# FIELDBUS CONNECTORS

## Industrial Ethernet

– with open ended wires M12

– Gigabit Ethernet CAT6A

### Male

straight



### Male

90°

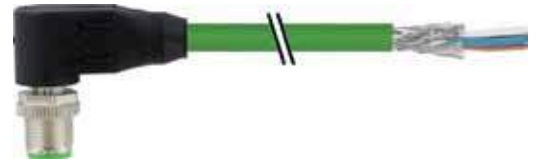

\* only for products with UL/CSA approved cable

<b>1 Form</b>	<b>21001</b>	<b>21021</b>	
	Approvals	cULus *	
	Type	8-pole, shielded X-coded	8-pole, shielded X-coded
	Circuit diagram		
Contact layout	<p>Male</p>		
<b>2 Cable Type</b>	<b>Jacket Color</b>	<b>Jacket Color</b>	
	4x2x0.14 mm <sup>2</sup> PUR (UL/CSA)	green 790	green 790
<b>3 Cable Length</b>	1.5 m	<b>0150</b>	
	3.0 m	<b>0300</b>	
	5.0 m	<b>0500</b>	
	7.5 m	<b>0750</b>	
	10.0 m	<b>1000</b>	
<b>Technical Data</b>			
Operating voltage	max. 50 V AC/60 V DC		
Protection	IP65 and IP67 when plugged and screwed down (EN 60529)		
Temperature range	-25...+85 °C, depending on cable quality		
<b>Article No.</b>			
The composition of your article number is explained on page 3.1.i	<div style="border: 1px solid black; padding: 5px; display: flex; justify-content: space-around;"> <span style="border-bottom: 1px solid black; padding: 0 10px;">7 0 0 0</span> <span>-</span> <span style="border-bottom: 1px solid black; padding: 0 10px;">-</span> <span>-</span> <span style="border-bottom: 1px solid black; padding: 0 10px;">-</span> </div>		
	<b>1 Form</b>	<b>2 Cable Type</b>	<b>3 Cable Length</b>
<b>Notes</b>	Other versions on request. Differing cable lengths up to 2 m can be ordered in 0.2 m steps, from 2 m on in 0.5 m steps. Connection accessories and general accessories can be found at the end of chapter 3.6.		

# FIELDBUS CONNECTORS

## Industrial Ethernet

– Connection cables M12 - M12

EtherNet/IP EtherCAT

PROFIBUS  
NET

Approvals:  

\* only for products with UL/CSA approved cable

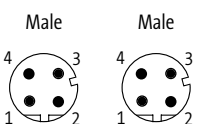

<b>1 Form</b>	<b>4 4 5 1 1</b>	<b>4 4 5 6 1</b>	
	Type 4-pole, shielded D-coded Circuit diagram 	Type 4-pole, shielded D-coded	
Contact layout 			
<b>2 Cable Type</b>	<b>Jacket Color</b>	<b>Jacket Color</b>	
	1x4x0.34 mm <sup>2</sup>	green    black    red	green    black    red
	PVC (UL/CSA), C-tracks	800	800
	PUR (UL/CSA), Torsion	793	793
	2x2x0.34 mm <sup>2</sup>		
	PUR (UL/CSA)	794	794
PUR (UL/CSA), robots/C-tracks	796    851    792	796    851    792	
PUR (UL/CSA), C-tracks, 600 V	659	659	
<b>3 Cable Length</b>	1.5 m	0150	
	3.0 m	0300	
	5.0 m	0500	
	7.5 m	0750	
	10.0 m	1000	
	<b>Technical Data</b>		
Operating voltage	max. 60 V DC		
Protection	IP65, IP66K, IP67 inserted and tightened (EN 60529)		
Temperature range	-25...+85 °C, depending on cable quality		
<b>Article No.</b>			
The composition of your article number is explained on page 3.1.i	7 0 0 0 - - - - - - - - - -		
	1 Form    2 Cable Type    3 Cable Length		
<b>Notes</b>	Other versions on request. Differing cable lengths up to 2 m can be ordered in 0.2 m steps, from 2 m on in 0.5 m steps. Connection accessories and general accessories can be found at the end of chapter 3.6.		

Fieldbus Connectors

# FIELDBUS CONNECTORS

## Industrial Ethernet

– Connection cables M12 - RJ45

EtherNet/IP EtherCAT



\* only for products with UL/CSA approved cable

**Male**  
straight

**Male**  
straight

**Male**  
straight

**Male**  
45° on bottom



<b>1 Form</b>	<b>4 4 7 1 1</b>	<b>4 4 7 3 1</b>
---------------	------------------	------------------

Type	4-pole, shielded D-coded	4-pole, shielded D-coded
------	-----------------------------	-----------------------------

Circuit diagram		
Contact layout		

<b>2 Cable Type</b>	<b>Jacket Color</b>	<b>Jacket Color</b>
---------------------	---------------------	---------------------

1×4×0.34 mm <sup>2</sup>	green	black	red	green	black	red
PVC (UL/CSA), C-tracks	800			800		
PUR (UL/CSA), Torsion	793			793		
2×2×0.34 mm <sup>2</sup>						
PUR (UL/CSA)	794			794		
PUR (UL/CSA), robots/C-tracks	796	851	792	796	851	792
PUR (UL/CSA), C-tracks, 600 V	659			659		

<b>3 Cable Length</b>	
-----------------------	--

1.5 m	0150
3.0 m	0300
5.0 m	0500
7.5 m	0750
10.0 m	1000

<b>Technical Data</b>	
-----------------------	--

Operating voltage	max. 60 V DC
Protection	IP67 (M12) - IP20 (RJ45)
Temperature range	-25...+85 °C, depending on cable quality

<b>Article No.</b>	
--------------------	--

The composition of your article number is explained on page 3.1.i	7 0 0 0 - - - - -
---	-------------------

	<b>1 Form</b>	<b>2 Cable Type</b>	<b>3 Cable Length</b>
--	---------------	---------------------	-----------------------

<b>Notes</b>	
--------------	--

Other versions on request. Differing cable lengths up to 2 m can be ordered in 0.2 m steps, from 2 m on in 0.5 m steps.  
Connection accessories and general accessories can be found at the end of chapter 3.6.

# FIELDBUS CONNECTORS

## Industrial Ethernet

– Connection cables M12 - M12

– Hybrid cable

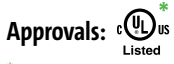

\* only for products with UL/CSA approved cable

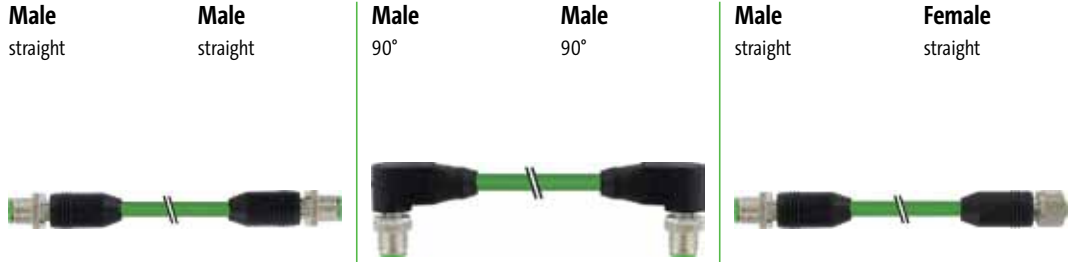

1 Form	47001	47021	47051										
Type	8-pole, shielded Y-coded	8-pole, shielded Y-coded	8-pole, shielded Y-coded										
Circuit diagram													
Contact layout													
2 Cable Type	Jacket Color	Jacket Color	Jacket Color										
4x0.5 + 1x4x0.14 mm <sup>2</sup> PUR (UL/CSA), robots/Ctracks	<table border="1"> <tr> <td>black</td> <td>green</td> </tr> <tr> <td>805</td> <td>831</td> </tr> </table>	black	green	805	831	<table border="1"> <tr> <td>black</td> <td>green</td> </tr> <tr> <td>805</td> <td>831</td> </tr> </table>	black	green	805	831	<table border="1"> <tr> <td>green</td> </tr> <tr> <td>831</td> </tr> </table>	green	831
black	green												
805	831												
black	green												
805	831												
green													
831													
3 Cable Length	<table border="1"> <tr> <td>1.5 m</td> <td>0150</td> </tr> <tr> <td>3.0 m</td> <td>0300</td> </tr> <tr> <td>5.0 m</td> <td>0500</td> </tr> <tr> <td>7.5 m</td> <td>0750</td> </tr> <tr> <td>10.0 m</td> <td>1000</td> </tr> </table>			1.5 m	0150	3.0 m	0300	5.0 m	0500	7.5 m	0750	10.0 m	1000
1.5 m	0150												
3.0 m	0300												
5.0 m	0500												
7.5 m	0750												
10.0 m	1000												
Technical Data	<table border="1"> <tr> <td>Operating voltage</td> <td>max. 50 V AC/DC</td> </tr> <tr> <td>Protection</td> <td>IP65 and IP67 when plugged and screwed down (EN 60529)</td> </tr> <tr> <td>Temperature range</td> <td>-25...+85 °C, depending on cable quality</td> </tr> </table>			Operating voltage	max. 50 V AC/DC	Protection	IP65 and IP67 when plugged and screwed down (EN 60529)	Temperature range	-25...+85 °C, depending on cable quality				
Operating voltage	max. 50 V AC/DC												
Protection	IP65 and IP67 when plugged and screwed down (EN 60529)												
Temperature range	-25...+85 °C, depending on cable quality												
Article No.	<p>The composition of your article number is explained on page 3.1.i</p> <p><b>7 0 0 0</b> - - - - -</p>												
	<b>1</b> Form	<b>2</b> Cable Type	<b>3</b> Cable Length										
Notes	<p>Other versions on request. Differing cable lengths up to 2 m can be ordered in 0.2 m steps, from 2 m on in 0.5 m steps. Connection accessories and general accessories can be found at the end of chapter 3.6.</p>												

Fieldbus Connectors

# FIELDBUS CONNECTORS

## Industrial Ethernet

– Connection cables M12 - M12

– Gigabit Ethernet CAT6A

**Male**

straight

**Male**

straight

**Male**

90°

**Male**

90°



\* only for products with UL/CSA approved cable

<b>1 Form</b>	<b>51001</b>	<b>51021</b>
Approvals	cULus *	
Type	8-pole, shielded X-coded	8-pole, shielded X-coded
Circuit diagram		
Contact layout		
<b>2 Cable Type</b>	<b>Jacket Color</b>	<b>Jacket Color</b>
4x2x0.14 mm <sup>2</sup> PUR (UL/CSA)	green 790	green 790
<b>3 Cable Length</b>		
1.5 m	<b>0150</b>	
3.0 m	<b>0300</b>	
5.0 m	<b>0500</b>	
7.5 m	<b>0750</b>	
10.0 m	<b>1000</b>	
<b>Technical Data</b>		
Operating voltage	max. 50 V AC/60 V DC	
Protection	IP65 and IP67 when plugged and screwed down (EN 60529)	
Temperature range	-25...+85 °C, depending on cable quality	
<b>Article No.</b>		
The composition of your article number is explained on page 3.1.i	<div style="display: flex; justify-content: space-around; align-items: center;"> <span style="border: 1px solid black; padding: 2px;">7</span> <span style="border: 1px solid black; padding: 2px;">0</span> <span style="border: 1px solid black; padding: 2px;">0</span> <span style="border: 1px solid black; padding: 2px;">0</span> <span style="font-size: 2em;">-</span> <span style="border: 1px solid black; padding: 2px;">_</span> <span style="font-size: 2em;">-</span> <span style="border: 1px solid black; padding: 2px;">_</span> <span style="border: 1px solid black; padding: 2px;">_</span> <span style="border: 1px solid black; padding: 2px;">_</span> </div>	
	<b>1 Form</b>	<b>2 Cable Type</b>
		<b>3 Cable Length</b>
<b>Notes</b>	Other versions on request. Differing cable lengths up to 2 m can be ordered in 0.2 m steps, from 2 m on in 0.5 m steps. Connection accessories and general accessories can be found at the end of chapter 3.6.	



# FIELDBUS CONNECTORS

## Industrial Ethernet

– Connection cables M12 - RJ45

– Gigabit Ethernet CAT6A

**Male**  
straight

**Male**  
straight

**Male**  
straight

**Flange female**  
straight



### 1 Form

**51101**

**51551**

#### Type

8-pole, shielded

8-pole, shielded

#### Circuit diagram

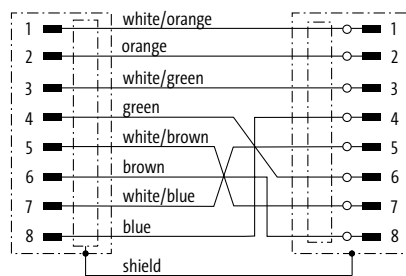

X-coded

X-coded

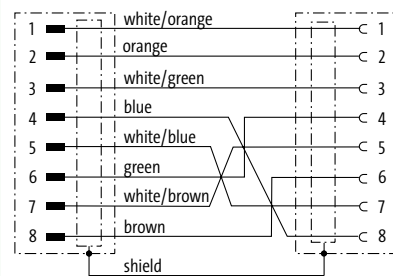

#### Contact layout

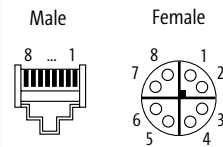
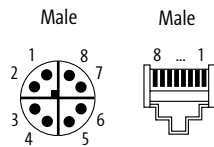

### 2 Cable Type

**Jacket Color**

**Jacket Color**

4×2×0.14 mm<sup>2</sup>  
PUR (UL/CSA)

green  
790

green  
790

### 3 Cable Length

1.5 m	<b>0150</b>
3.0 m	<b>0300</b>
5.0 m	<b>0500</b>
7.5 m	<b>0750</b>
10.0 m	<b>1000</b>

#### Technical Data

Operating voltage	max. 60 V DC
Protection	IP67 (M12) - IP20 (RJ45)
Temperature range	-25...+85 °C, depending on cable quality

#### Article No.

The composition of your article number is explained on page 3.1.i

**7 0 0 0** - - - - -

**1** Form

**2** Cable Type

**3** Cable Length

#### Notes

Other versions on request. Differing cable lengths up to 2 m can be ordered in 0.2 m steps, from 2 m on in 0.5 m steps. Connection accessories and general accessories can be found at the end of chapter 3.6.

# FIELDBUS CONNECTORS

## Industrial Ethernet

– with open ended wires RJ45

EtherNet/IP EtherCAT

PROFINET

Approvals:  <sup>\*</sup>  
Listed

\* only for products with UL/CSA approved cable

### Male

straight



### Male

45° on top



### Male

45° on bottom

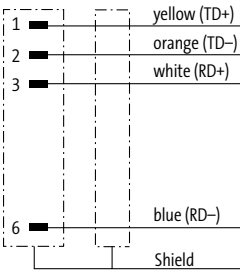
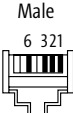

1 Form	74101	74121	74141
Type	4-pole, shielded	4-pole, shielded	4-pole, shielded
Circuit diagram			
Contact layout			
2 Cable Type	Jacket Color	Jacket Color	Jacket Color
1×4×0.34 mm <sup>2</sup>	green black red	green black red	green black red
PVC (UL/CSA), C-tracks	800	800	800
PUR (UL/CSA), Torsion	793	793	793
2×2×0.34 mm <sup>2</sup>			
PUR (UL/CSA)	794	794	794
PUR (UL/CSA), robots/C-tracks	796 851 792	796 851 792	796 851 792
PUR (UL/CSA), C-tracks, 600 V	659	659	659
3 Cable Length			
1.5 m	0150		
3.0 m	0300		
5.0 m	0500		
7.5 m	0750		
10.0 m	1000		
Technical Data			
Operating voltage	max. 60 V DC		
Protection	IP20 inserted and tightened (EN 60529)		
Temperature range	-25...+85 °C, depending on cable quality		
Article No.			
The composition of your article number is explained on page 3.1.i	<div style="display: flex; justify-content: space-around; align-items: center;"> <span style="border-bottom: 1px solid black; padding: 0 5px;">7</span> <span style="border-bottom: 1px solid black; padding: 0 5px;">0</span> <span style="border-bottom: 1px solid black; padding: 0 5px;">0</span> <span style="border-bottom: 1px solid black; padding: 0 5px;">0</span> <span style="font-size: 2em;">-</span> <span style="border-bottom: 1px solid black; padding: 0 5px;">_</span> <span style="font-size: 2em;">-</span> <span style="border-bottom: 1px solid black; padding: 0 5px;">_</span> <span style="border-bottom: 1px solid black; padding: 0 5px;">_</span> <span style="border-bottom: 1px solid black; padding: 0 5px;">_</span> </div>		
	<b>1</b>	<b>2</b>	<b>3</b>
	Form	Cable Type	Cable Length
Notes	Other versions on request. Differing cable lengths up to 2 m can be ordered in 0.2 m steps, from 2 m on in 0.5 m steps. Connection accessories and general accessories can be found at the end of chapter 3.6.		

# FIELDBUS CONNECTORS

## Industrial Ethernet

– with open ended wires RJ45

EtherNet/IP EtherCAT

PROFINET

Approvals:  <sup>\*</sup>  
Listed

\* only for products with UL/CSA approved cable

Male  
45° left



Male  
45° right



### 1 Form

**74161**

**74181**

Type  
Circuit diagram

4-pole, shielded

4-pole, shielded

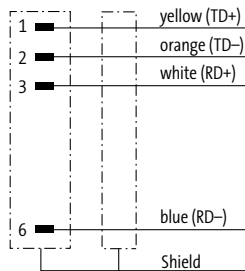

Contact layout



### 2 Cable Type

Jacket Color

Jacket Color

	green	black	red	green	black	red
1x4x0.34 mm <sup>2</sup>	800			800		
PVC (UL/CSA), C-tracks	800			800		
PUR (UL/CSA), Torsion	793			793		
2x2x0.34 mm <sup>2</sup>						
PUR (UL/CSA)	794			794		
PUR (UL/CSA), robots/C-tracks	796	851	792	796	851	792
PUR (UL/CSA), C-tracks, 600 V	659			659		

### 3 Cable Length

1.5 m	0150
3.0 m	0300
5.0 m	0500
7.5 m	0750
10.0 m	1000

### Technical Data

Operating voltage	max. 60 V DC
Protection	IP20 inserted and tightened (EN 60529)
Temperature range	-25...+85 °C, depending on cable quality

### Article No.

The composition of your article number is explained on page 3.1.i

7 0 0 0 - - - - -

**1** Form

**2** Cable Type

**3** Cable Length

### Notes

Other versions on request. Differing cable lengths up to 2 m can be ordered in 0.2 m steps, from 2 m on in 0.5 m steps. Connection accessories and general accessories can be found at the end of chapter 3.6.

# FIELDBUS CONNECTORS

## Industrial Ethernet

– Connection cables RJ45 - RJ45

EtherNet/IP EtherCAT

PROFINET

Approvals:  <sup>\*</sup>  
Listed

\* only for products with UL/CSA approved cable

Male  
straight

Male  
straight

Male  
45° on bottom

Male  
45° right



<b>1 Form</b>	<b>74301</b>	<b>74521</b>
---------------	--------------	--------------

Type	4-pole, shielded	4-pole, shielded
------	------------------	------------------

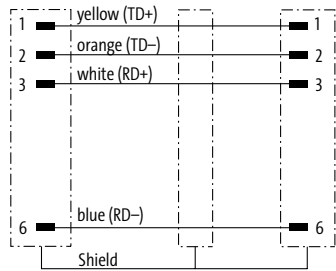
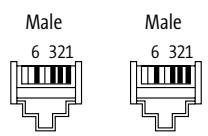
Circuit diagram		
Contact layout		

2 Cable Type	Jacket Color			Jacket Color		
	green	black	red	green	black	red
1×4×0.34 mm <sup>2</sup> PVC (UL/CSA), C-tracks	800			800		
PUR (UL/CSA), Torsion	793			793		
2×2×0.34 mm <sup>2</sup> PUR (UL/CSA)	794			794		
PUR (UL/CSA), robots/C-tracks	796	851	792	796	851	792
PUR (UL/CSA), C-tracks, 600 V	659			659		

3 Cable Length	
1.5 m	0150
3.0 m	0300
5.0 m	0500
7.5 m	0750
10.0 m	1000

Technical Data	
Operating voltage	max. 60 V DC
Protection	IP20 inserted and tightened (EN 60529)
Temperature range	-25...+85 °C, depending on cable quality

Article No.	
-------------	--

The composition of your article number is explained on page 3.1.i	<b>7 0 0 0</b> - - - - -
---	--------------------------

	<b>1 Form</b>	<b>2 Cable Type</b>	<b>3 Cable Length</b>
--	---------------	---------------------	-----------------------

Notes	Other versions on request. Differing cable lengths up to 2 m can be ordered in 0.2 m steps, from 2 m on in 0.5 m steps. Connection accessories and general accessories can be found at the end of chapter 3.6.
-------	---

# FIELDBUS CONNECTORS

## Industrial Ethernet

- Connection cables RJ45 - RJ45
- Gigabit Ethernet CAT6A

Male

straight

Male

straight



### 1 Form

**74311**

Type

8-pole, shielded

Circuit diagram

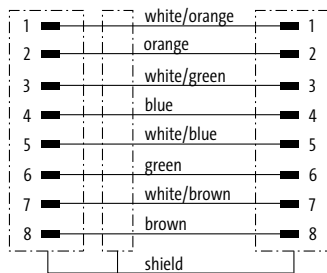

Contact layout

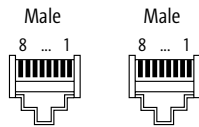

### 2 Cable Type

Jacket Color

4x2x0.14 mm<sup>2</sup>

green

PUR (UL/CSA)

790

### 3 Cable Length

1.5 m

0150

3.0 m

0300

5.0 m

0500

7.5 m

0750

10.0 m

1000

### Technical Data

Operating voltage

max. 60 V DC

Protection

IP20 inserted and tightened (EN 60529)

Temperature range

-25...+85 °C, depending on cable quality

### Article No.

The composition of your article number is explained on page 3.1.i

7 0 0 0

-

7 4 3 1 1

-

\_\_\_\_

\_\_\_\_

**1**

Form

**2**

Cable Type

**3**

Cable Length

Notes

Other versions on request. Differing cable lengths up to 2 m can be ordered in 0.2 m steps, from 2 m on in 0.5 m steps. Connection accessories and general accessories can be found at the end of chapter 3.6.

# FIELDBUS CONNECTORS

Cabinetline

– Connection cables RJ45 - RJ45

Male  
straight

Male  
straight

Male  
straight

Male  
straight



<b>1 Form</b>	<b>74701</b>	<b>74711</b>		
	Type 4-pole, shielded	Type 8-pole, shielded		
Circuit diagram				
Contact layout				
<b>2 Cable Type</b>	<b>Jacket Color</b>	<b>Jacket Color</b>		
	4×2×0.14 mm <sup>2</sup> FRNC	gray	green	black
2×2×0.14 mm <sup>2</sup> FRNC, Ctracks	777	478	380	578
<b>3 Cable Length</b>	1.5 m	0150		
	3.0 m	0300		
	5.0 m	0500		
	7.5 m	0750		
	10.0 m	1000		
<b>Technical Data</b>	Operating voltage			
	max. 60 V DC			
	Protection			
	IP20 inserted and tightened (EN 60529)			
	Temperature range			
	-25...+85 °C, depending on cable quality			
<b>Article No.</b>	The composition of your article number is explained on page 3.1.i			
	7 0 0 0	-	-	-
	<b>1 Form</b>	<b>2 Cable Type</b>	<b>3 Cable Length</b>	
<b>Notes</b>	Other versions on request. Differing cable lengths up to 2 m can be ordered in 0.2 m steps, from 2 m on in 0.5 m steps. Connection accessories and general accessories can be found at the end of chapter 3.6.			

# FIELDBUS CONNECTORS

Ethernet CAT5e

– Push Pull RJ45

– AIDA conform



Approvals: <sup>\*</sup>  
Listed

\* only for products with UL/CSA approved cable

Male

straight



Male

straight

Male

straight



## 1 Form

**74 6 0 1**

**74 6 4 1**

Type  
Circuit diagram

4-pole, shielded

4-pole, shielded

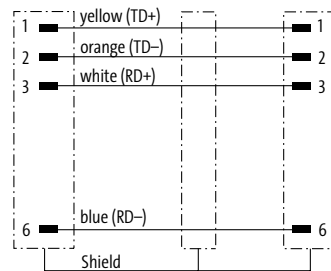
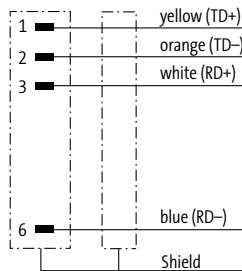

Contact layout

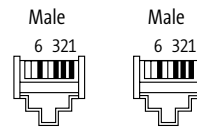
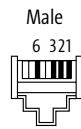

## 2 Cable Type

Jacket Color

Jacket Color

2x2x0.34 mm<sup>2</sup>  
PUR (UL/CSA)  
PUR (UL/CSA), robots/Ctracks

green  
794  
796

green  
794  
796

## 3 Cable Length

1.5 m **0150**  
3.0 m **0300**  
5.0 m **0500**  
7.5 m **0750**  
10.0 m **1000**

## Technical Data

Operating voltage max. 60 V DC  
Protection IP65 and IP67 when plugged and screwed down (EN 60529)  
Temperature range -25...+85 °C, depending on cable quality

## Article No.

The composition of your article number is explained on page 3.1.i

**7 0 0 0** - - - - -

**1** Form

**2** Cable Type

**3** Cable Length

Notes

Other versions on request. Further cable lengths on request.  
Connection accessories and general accessories can be found at the end of chapter 3.6.

# FIELDBUS CONNECTORS

Push Pull Power

**Male**  
straight



**Male**  
straight



**Male**  
straight

<b>1 Form</b>	<b>99621</b>	<b>99641</b>
	<p><b>Type</b> 5-pole</p> <p><b>Circuit diagram</b></p> <p><b>Contact layout</b></p>	<p><b>Type</b> 5-pole</p> <p><b>Circuit diagram</b></p> <p><b>Contact layout</b></p>
<b>2 Cable Type</b>	<b>Jacket Color</b>	<b>Jacket Color</b>
	<p>Wire diameter 2.5 mm<sup>2</sup> PUR (UL/CSA), robots/Ctracks</p> <p>gray 962</p>	<p>gray 962</p>
<b>3 Cable Length</b>	1.5 m	<b>0150</b>
	3.0 m	<b>0300</b>
	5.0 m	<b>0500</b>
	7.5 m	<b>0750</b>
	10.0 m	<b>1000</b>
<b>Technical Data</b>	<p>Operating voltage: max. 24 V AC/DC</p> <p>Protection: IP65 and IP67 when plugged and screwed down (EN 60529)</p> <p>Temperature range: -40...+85 °C, depending on cable quality</p>	
<b>Article No.</b>	<p>The composition of your article number is explained on page 3.1.i</p> <p><b>7 0 0 0</b> - - - - -</p>	
	<b>1 Form</b>	<b>2 Cable Type</b>
		<b>3 Cable Length</b>
<b>Notes</b>	<p>Other versions on request. Further cable lengths on request. Connection accessories and general accessories can be found at the end of chapter 3.6.</p>	



# FIELDBUS CONNECTORS

## Cube67

- with open ended wires M12
- Actuator supply external

Approvals:  

\* only for products with UL/CSA approved cable

Female  
straight



Female  
90°



### 1 Form

15001

15021

Type

2-pole

2-pole

Circuit diagram

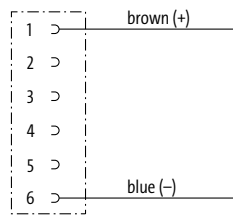

Contact layout

Female

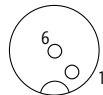

### 2 Cable Type

Jacket Color

Jacket Color

Wire diameter 0.5 mm<sup>2</sup>  
PUR (UL/CSA), robots/C/tracks

gray  
414

gray  
414

### 3 Cable Length

1.5 m	0150
3.0 m	0300
5.0 m	0500
7.5 m	0750
10.0 m	1000

### Technical Data

Operating voltage	max. 30 V AC/DC
Protection	IP67 inserted and tightened (EN 60529)
Temperature range	-25...+85 °C, depending on cable quality

### Article No.

The composition of your article number is explained on page 3.1.i

7 0 0 0

M12 Lite (plastic hexagonal screw) on request

7 0 0 5

1 Form

2 Cable Type

3 Cable Length

Notes

Other versions on request. Differing cable lengths up to 2 m can be ordered in 0.2 m steps, from 2 m on in 0.5 m steps.  
Connection accessories and general accessories can be found at the end of chapter 3.6.

# FIELD BUS CONNECTORS

## Cube67

– Connection cables M12 - M12

– Hybrid cable

**Male**  
straight

**Female**  
straight

**Male**  
90°

**Female**  
90°



\* only for products with UL/CSA approved cable

<b>1 Form</b>	<b>46041</b>	<b>46061</b>
Type	6-pole, shielded	6-pole, shielded
Circuit diagram		
Contact layout		
<b>2 Cable Type</b>	<b>Jacket Color</b>	<b>Jacket Color</b>
4x0.5 + 2x0.25 mm <sup>2</sup>	green	green
PUR (UL/CSA), robots/C-tracks	802	802
Terminator M12 (male)	7000-15041-0000000	
Control cabinet entry system M12	7000-46111-0000000	
T-coupler M12/M12, female/male	7000-46101-0000000	
<b>3 Cable Length</b>		
1.5 m	0150	
3.0 m	0300	
5.0 m	0500	
7.5 m	0750	
10.0 m	1000	
<b>Technical Data</b>		
Operating voltage	max. 30 V AC/DC	
Protection	IP65 and IP67 when plugged and screwed down (EN 60529)	
Temperature range	-25...+85 °C, depending on cable quality	
<b>Article No.</b>		
The composition of your article number is explained on page 3.1.i	<div style="display: flex; justify-content: space-around; align-items: center;"> <span style="border: 1px solid black; padding: 2px;">7</span> <span style="border: 1px solid black; padding: 2px;">0</span> <span style="border: 1px solid black; padding: 2px;">0</span> <span style="border: 1px solid black; padding: 2px;">0</span> <span style="font-size: 2em;">-</span> <span style="border: 1px solid black; padding: 2px;">_</span> <span style="font-size: 2em;">-</span> <span style="border: 1px solid black; padding: 2px;">_</span> <span style="border: 1px solid black; padding: 2px;">_</span> <span style="border: 1px solid black; padding: 2px;">_</span> </div>	
	<b>1 Form</b>	<b>2 Cable Type</b>
		<b>3 Cable Length</b>
<b>Notes</b>	Other versions on request. Differing cable lengths up to 2 m can be ordered in 0.2 m steps, from 2 m on in 0.5 m steps. Connection accessories and general accessories can be found at the end of chapter 3.6.	

# FIELDBUS CONNECTORS

## AS-Interface

– Connection cables M12 - M12

– for MASI68



\* only for products with UL/CSA approved cable

## Male

straight

## Female

straight



1 Form	40005	40021
Type	2-pole	4-pole
Circuit diagram		
Contact layout		
2 Cable Type	Jacket Color	Jacket Color
Wire diameter 1.5 mm <sup>2</sup> PUR (UL/CSA), robots/C-tracks	gray 588	gray
Wire diameter 0.75 mm <sup>2</sup> PUR (UL/CSA), robots/C-tracks		862
3 Cable Length		
1.5 m	0150	
3.0 m	0300	
5.0 m	0500	
7.5 m	0750	
10.0 m	1000	
Technical Data		
Operating voltage	max. 250 V AC/DC	
Protection	IP67/IP68 inserted and tightened (EN 60529)	
Temperature range	-25...+85 °C, depending on cable quality	
Article No.		
The composition of your article number is explained on page 3.1.i	7 0 6 0 - - - - -	- - - - -
	1 Form	2 Cable Type 3 Cable Length
Notes	Other versions on request. Differing cable lengths up to 2 m can be ordered in 0.2 m steps, from 2 m on in 0.5 m steps. Connection accessories and general accessories can be found at the end of chapter 3.6.	

# FIELDBUS CONNECTORS

Connection accessories			Art-No.
	<b>T-coupler M12 – M12</b> Male straight - female/male straight straight, B-coded, 5-pole, shielded	PROFIBUS	7000-44151-0000000
	<b>T-coupler M12 – M12</b> Female straight - male/female straight straight, B-coded, 5-pole, shielded	PROFIBUS	7000-44161-0000000
	<b>T-coupler M12 – M12</b> Male straight - female straight straight, A-coded, 6-pole, shielded	Cube67 additional actuator power supply	7000-46101-0000000
	<b>T-coupler M12 – M12</b> Female straight - male/male straight straight, A-coded, 4-pole	MAS168 additional actuator power supply	7060-42701-0000000
	<b>Male M12, field-wireable, screw terminals</b> straight, B-coded, 5-pole, shielded	PROFIBUS, Interbus Sealing range (cable Ø): 6...8 mm	7000-14001-0000000
	<b>Female M12, field-wireable, screw terminals</b> straight, B-coded, 5-pole, shielded	PROFIBUS, Interbus Sealing range (cable Ø): 6...8 mm	7000-14021-0000000
	<b>Male M12, field-wireable, screw terminals</b> 90°, B-coded, 5-pole, shielded	PROFIBUS, Interbus Sealing range (cable Ø): 6...8 mm	7000-14011-0000000
	90°, D-coded, 4-pole, shielded	Ethernet CAT5 Sealing range (cable Ø): 6...8 mm	7000-14581-0000000
	<b>Female M12, field-wireable, screw terminals</b> 90°, B-coded, 5-pole, shielded	PROFIBUS, Interbus Sealing range (cable Ø): 6...8 mm	7000-14031-0000000
	<b>Male M12, field-wireable, IDC terminals</b> straight, B-coded, 3-pole, shielded	PROFIBUS Sealing range (cable Ø): 7...8.8 mm	7000-14201-0000000
	straight, D-coded, 4-pole, shielded	Ethernet CAT5 Sealing range (cable Ø): 4.5...8.8 mm	7000-14521-0000000
	<b>Female M12, field-wireable, IDC terminals</b> straight, B-coded, 3-pole, shielded	PROFIBUS Sealing range (cable Ø): 7...8.8 mm	7000-14221-0000000
	straight, D-coded, 4-pole, shielded	Ethernet CAT5 Sealing range (cable Ø): 4.5...8.8 mm	7000-14621-0000000

## FIELDBUS CONNECTORS

Connection accessories			Art-No.
	<b>Male M12, field-wireable, screw terminals</b> straight, A-coded, 5-pole	DeviceNet, CANopen Sealing range (cable Ø): 6...8 mm	<b>7000-12761-0000000</b>
	<b>Female M12, field-wireable, screw terminals</b> straight, A-coded, 5-pole	DeviceNet, CANopen Sealing range (cable Ø): 6...8 mm	<b>7000-12961-0000000</b>
	<b>Male M12, field-wireable, screw terminals</b> 90°, A-coded, 5-pole	DeviceNet, CANopen Sealing range (cable Ø): 6...8 mm	<b>7000-12881-0000000</b>
	<b>Female M12, field-wireable, screw terminals</b> 90°, A-coded, 5-pole	DeviceNet, CANopen Sealing range (cable Ø): 6...8 mm	<b>7000-13041-0000000</b>
	<b>Male RJ45, field-wireable, IDC terminals</b> straight, IP20, 4-pole, shielded	Ethernet CAT5 Sealing range (cable Ø): 4.5...9 mm	<b>7000-74001-0000000</b>
	straight, IP20, 8-pole, shielded	Ethernet CAT6A Sealing range (cable Ø): 4.5...9 mm	<b>7000-74011-0000000</b>
	straight, IP20, 8-pole, shielded	PROFINET Ethernet CAT5 Sealing range (cable Ø): 5...9 mm	<b>7000-74071-0000000</b>
	straight, IP20, 8-pole, shielded	Ethernet CAT5 Sealing range (cable Ø): 5...9 mm	<b>7000-74075-0000000</b>
	<b>Male RJ45, field-wireable, IDC terminals</b> 45°, IP20, 4-pole, shielded	Ethernet CAT5e Sealing range (cable Ø): 4.5...8 mm	<b>7000-74021-0000000</b>
	45°, IP20, 8-pole, shielded	Ethernet CAT6A Sealing range (cable Ø): 4.5...8 mm	<b>7000-74031-0000000</b>
	<b>Male RJ45, field-wireable, IDC terminals</b> 90°, IP20, 8-pole, shielded on top	Ethernet CAT5 PROFINET Sealing range (cable Ø): 5...9 mm	<b>7000-74081-0000000</b>
	90°, IP20, 8-pole, shielded on top	Ethernet CAT5 Sealing range (cable Ø): 5...9 mm	<b>7000-74085-0000000</b>
	90°, IP20, 8-pole, shielded on bottom	Ethernet CAT5 PROFINET Sealing range (cable Ø): 5...9 mm	<b>7000-74091-0000000</b>
	90°, IP20, 8-pole, shielded on bottom	Ethernet CAT5 Sealing range (cable Ø): 5...9 mm	<b>7000-74095-0000000</b>

Connection accessories			Art-No.
	<b>Adapter M12/RJ45 (female/female)</b> straight, D-coded, 4-pole, shielded	Ethernet CAT5	7000-44671-0000000
	<b>Adapter M12/RJ45 (female/female)</b> 90°, D-coded, 4-pole, shielded	Ethernet CAT5	7000-44681-0000000
	<b>Adapter M12/RJ45 (female/female)</b> straight, X-coded, 8-pole, shielded	Ethernet CAT6A	7000-51531-0000000
	<b>Adapter M12/RJ45 (female/female)</b> 90°, X-coded, 8-pole, shielded	Ethernet CAT6A	7000-51541-0000000
	<b>Terminator M12 (male)</b> straight, A-coded, 5-pole	DeviceNet, CANopen	7000-13461-0000000
	straight, B-coded, 4-pole	PROFIBUS	7000-14041-0000000
	straight, A-coded, 6-pole	Cube67	7000-15041-0000000
	<b>Terminator 7/8" (male)</b> straight, screw fixing, 5-pole	DeviceNet, CANopen	7000-78301-0000000
	<b>Male M12, field-wireable, IDC terminals</b> straight, X-coded, 8-pole, shielded	Ethernet CAT6A Sealing range (cable Ø): 5.5...9 mm	7000-21101-0000000
	<b>M12 Flange female straight</b> straight, X-coded, 8-pole, shielded Front mounting	Ethernet CAT6A	7000-21151-0000000
	straight, X-coded, 8-pole, shielded Rear mounting	Ethernet CAT6A	7000-21161-0000000
	<b>M12 Flange female straight</b> straight, Y-coded, 8-pole, shielded Front mounting	Ethernet CAT5	7000-15701-0000000

## FIELDBUS CONNECTORS

Connection accessories			Art-No.
	<b>M12 Flange female 90°</b> 90°, Y-coded, 8-pole, shielded Front mounting	Ethernet CAT5	7000-15711-000000
	<b>Control cabinet entry system M12</b> straight, A-coded, 5-pole, shielded straight, B-coded, 5-pole, shielded straight, A-coded, 6-pole, shielded	DeviceNet, CANopen PROFIBUS, Interbus Cube67	7000-42111-000000 7000-44111-000000 7000-46111-000000
	<b>Control cabinet entry system M12</b> straight, D-coded, 4-pole, shielded (female/female)	Ethernet CAT5	7000-44611-000000
	<b>Flange M12 male, pre-wired 0.2 m</b> straight, B-coded, 5-pole straight, A-coded, 5-pole	PROFIBUS, Interbus DeviceNet, CANopen	7000-14121-9750020 7000-13521-9720020
	<b>Flange M12 female, pre-wired 0.2 m</b> straight, B-coded, 5-pole straight, A-coded, 5-pole	PROFIBUS, Interbus DeviceNet, CANopen	7000-14161-9750020 7000-13561-9720020
	<b>Flange M12 female, CAT 5, pre-wired 0.2 m</b> straight, D-coded, 4-pole, shielded	Ethernet CAT5	7000-14501-9760020
	<b>Push Pull Power connector, spring clamp terminals</b> straight, IP65/67, 5-pole	Sealing range (cable Ø): 9...13 mm	7000-99601-000000
	<b>Push Pull RJ45 data connector, IDC terminals</b> straight, IP65/67, 8-pole	Ethernet CAT5 Sealing range (cable Ø): 5.5...10 mm	7000-99591-000000
	<b>Push Pull RJ45 data connector, IDC terminals</b> straight, IP65/67, 4-pole	PROFINET IO Sealing range (cable Ø): 4...11 mm	7000-74041-000000



Connection accessories			Art-No.
	<p><b>Push Pull RJ45 data connector, IDC terminals</b> 45°, IP65/67, 4-pole</p>	<p>PROFINET IO Sealing range (cable Ø): 6.5...9.5 mm</p>	<p><b>7000-74061-0000000</b></p>
	<p><b>Push Pull SCRJ POF male, field-wireable</b> straight, IP65/67, for POF 1 mm</p>	<p>PROFINET IO Sealing range (cable Ø): 6.5...9.5 mm</p>	<p><b>7000-99701-0000000</b></p>
	<p><b>Push Pull SCRJ POF male, field-wireable</b> straight, IP65/67, for POF 1 mm Connection Crimp</p>	<p>PROFINET IO Sealing range (cable Ø): 6.5...9.5 mm</p>	<p><b>7000-99691-0000000</b></p>
	<p><b>Push Pull SCRJ POF male, field-wireable</b> straight Connection Crimp</p>		<p><b>7000-99695-0000000</b></p>
	<p><b>Protective cover</b> Push Pull Power</p>		<p><b>7000-99661-0000000</b></p>
	<p><b>Protective cover</b> Push Pull RJ45</p>		<p><b>7000-99671-0000000</b></p>
	<p><b>Cable drum (100 m)</b> 1 × 2 × 0.64 mm<sup>2</sup>, violet suitable for C-tracks</p>	<p>PROFIBUS</p>	<p><b>7000-C0201-8400000</b></p>
	<p><b>Cable drum (100 m)</b> 2 × 0.25 + 2 × 0.34 mm<sup>2</sup>, violet suitable for C-tracks</p>	<p>DeviceNet, CANopen</p>	<p><b>7000-C0201-8030000</b></p>



# FIELDBUS CONNECTORS

Connection accessories			Art-No.
	<b>Cable drum (100 m)</b> 2 × 2 × 0.34 mm <sup>2</sup> , green suitable for C-tracks	Ethernet CAT5, PROFINET IO, EtherCAT	<b>7000-C0201-7960000</b>
	<b>Cable drum (100 m)</b> 2 × 2 × 0.34 mm <sup>2</sup> , violet suitable for C-tracks	Ethernet CAT5, PROFINET IO, EtherCAT	<b>7000-C0201-7980000</b>
	<b>Cable drum (100 m)</b> 2 × 1.5 mm <sup>2</sup> , gray suitable for C-tracks	AS-Interface, MASI68	<b>7000-C0201-5880000</b>
	<b>Cable drum (100 m)</b> 4 × 0.75 mm <sup>2</sup> , gray suitable for C-tracks	AS-Interface, MASI68	<b>7000-C0201-8620000</b>
	<b>Bus Connection Plug 90°</b> SUB-D9 (female), screw terminals SUB-D9 (male), screw terminals	CANopen PROFIBUS	<b>55760</b> <b>55762</b>
	<b>Bus Connection Plug 180°</b> SUB-D9 (male), IDC terminals, rigid cable	PROFIBUS	<b>55584</b>
	<b>Bus Connection Plug 90°</b> SUB-D9 (male), IDC terminals, rigid cable	PROFIBUS	<b>55585</b>

Fieldbus Connectors

Connection accessories			Art-No.
	<p><b>Bus Connection Plug 90°</b> SUB-D9 (male), IDC terminals, rigid cable, programming device conn.</p>	<p>PROFIBUS</p>	<p>55586</p>
	<p><b>Bus Connection Plug 90°</b> SUB-D9 (male); M12 × 1, B-coded</p>	<p>PROFIBUS</p>	<p>7000-99441-0000000</p>
	<p><b>Bus Connection Plug 35°</b> SUB-D9 (male); M12 × 1, B-coded</p>	<p>PROFIBUS</p>	<p>7000-99401-0000000</p>
	<p><b>Bus Connection Plug 90°</b> SUB-D9 (male); M12 × 1, B-coded</p>	<p>PROFIBUS</p>	<p>7000-99411-0000000</p>
	<p><b>Bus Connection Plug 180°</b> SUB-D9 (male); M12 × 1, B-coded</p>	<p>PROFIBUS</p>	<p>7000-99421-0000000</p>
	<p><b>Bus Connection Plug 90°</b> SUB-D9 (male); M12 × 1, B-coded Zinc die casting</p>	<p>PROFIBUS</p>	<p>7000-99431-0000000</p>
Labeling accessories			Art-No.
	<p><b>Slip-on cable sleeve</b> for ACS label plates (4 × 18 mm)</p>	<p>Cable diameter (4...6.5 mm)</p>	<p>7000-99004-0000000</p>

## FIELDBUS CONNECTORS

Labeling accessories			Art-No.
	<b>Snap-on cable sleeve</b> for ACS label plates (4 × 18 mm)	Cable diameter (4.2...5.6 mm)	7000-99005-0000000
	for ACS label plates (4 × 18 mm)	Cable diameter (5...7 mm)	7000-99006-0000000
	<b>ACS label plate</b> for self marking (4 × 18 mm)		7000-99002-0000000
Mounting accessories			Art-No.
	<b>Torque wrench set</b> M8 (0.4 Nm, SW9)	M8 data connectors	7000-99101-0000000
	<b>Torque wrench set</b> M12 (0.6 Nm, SW13)	M12 data connector molded (standard)	7000-99102-0000000
End fitting accessories			Art-No.
	<b>Tube adapter</b> snap-in for corrugated tube (size 13mm)	Cable diameter (4...7 mm)	7000-99081-0000000



# CONNECTORS FOR FOOD & BEVERAGE

- Made with stainless steel
- Resistant to cleaning substances
- High protection degree

## MEETS DEMANDING HYGIENIC STANDARDS

The food and beverage industry needs an extremely clean environment – perfect hygiene is required. Products and components have to be highly resistant and handle tough environments. Murrelektronik offers a wide connector range for this industry and each product meets the tough requirements. All metal parts are made of stainless steel and the cables feature a PVC or TPE-S jacket.

Murrelektronik is closely connected to this industry and can fulfill all the important requirements of the food and beverage industry. And Murrelektronik offers even more:

- Complete system solutions
- Comprehensive diagnostic options
- Vibration-proof products
- Excellent logistics for fast deliveries
- Specialists with industry-specific knowledge

**ECOLAB**<sup>®</sup>



**STAINLESS STEEL**

## With Open Ended Wires

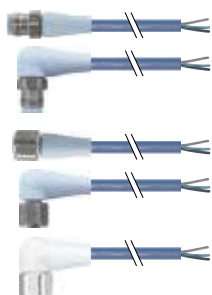

### M12 F&B Pro male

- Straight
- 90°

### M12 F&B Pro female

- Straight
- 90°
- 90° with LED

Page 3.7.1

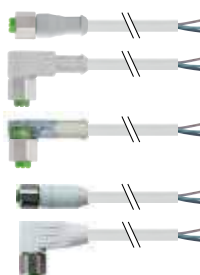

### M12 F&B female

- Straight
- 90°
- 90° with LED
- Straight (shielded)
- 90° (shielded)

Page 3.7.10

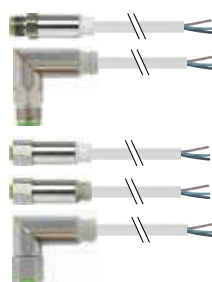

### M12 Steel male

- Straight
- 90°

### M12 Steel female

- Straight
- Straight with LED
- 90°

Page 3.7.15

## Connection Cables



**M12 F&B Pro male**  
• Straight  
• 90°

**M12 F&B Pro female**  
• Straight  
• 90°

*Page 3.7.19*



**M12 F&B male**  
• Straight

**M12 F&B female**  
• Straight  
• 90°  
• 90° with LED

*Page 3.7.14*



**M12 Steel male**  
• Straight  
• 90°

**M12 Steel female**  
• Straight  
• Straight with LED  
• 90°

*Page 3.7.16*

# PLUG CONNECTORS FOR FOOD & BEVERAGE

## M12 F&B Pro

- with open ended wires M12
- high resistance PP materials
- Screw, Stainless Steel 1.4404 (V4A)

Approvals: **ECOLAB**

**Male**  
straight



**Male**  
90°



<b>1 Form</b>	<b>12001</b>	<b>12081</b>
Type	3-pole	3-pole
Circuit diagram		
Contact layout	<p>Male</p>	
<b>2 Cable Type</b>	<b>Jacket Color</b>	<b>Jacket Color</b>
Wire diameter 0.34 mm <sup>2</sup> TPE-S (UL) robots/C-tracks	pastel blue 315	pastel blue 315
<b>3 Cable Length</b>		
1.5 m	<b>0150</b>	
3.0 m	<b>0300</b>	
5.0 m	<b>0500</b>	
7.5 m	<b>0750</b>	
10.0 m	<b>1000</b>	
<b>Technical Data</b>		
Operating voltage	max. 250 V AC/DC	
Protection	IP65/IP68/IP69K inserted and tightened (EN 60529)	
Temperature range	-40...+105 °C, depending on cable quality	
<b>Article No.</b>		
The composition of your article number is explained on page 3.1.i	<p><b>7 0 2 4</b> - - - - - - - - - -</p>	
	<b>1 Form</b>	<b>2 Cable Type</b>
		<b>3 Cable Length</b>
<b>Notes</b>	Other versions on request. Further cable lengths on request.	

# PLUG CONNECTORS FOR FOOD & BEVERAGE

## M12 F&B Pro

- with open ended wires M12
- high resistance PP materials
- Screw, Stainless Steel 1.4404 (V4A)

Approvals: **ECOLAB**

### Male

straight



### Male

90°



<b>1 Form</b>	<b>12021</b>	<b>12101</b>
	Type 4-pole	Type 4-pole
Circuit diagram		
Contact layout		
<b>2 Cable Type</b>	<b>Jacket Color</b>	<b>Jacket Color</b>
	Wire diameter 0.34 mm <sup>2</sup> TPE-S (UL) robots/C-tracks	pastel blue 321
<b>3 Cable Length</b>	1.5 m	0150
	3.0 m	0300
	5.0 m	0500
	7.5 m	0750
	10.0 m	1000
<b>Technical Data</b>	Operating voltage: max. 250 V AC/DC Protection: IP65/IP68/IP69K inserted and tightened (EN 60529) Temperature range: -40...+105 °C, depending on cable quality	
<b>Article No.</b>	The composition of your article number is explained on page 3.1.i 7 0 2 4 - - - - - - - - - -	
	<b>1 Form</b>	<b>2 Cable Type</b>
		<b>3 Cable Length</b>
<b>Notes</b>	Other versions on request. Further cable lengths on request.	

Plug Connectors for Food & Beverage

# PLUG CONNECTORS FOR FOOD & BEVERAGE

## M12 F&B Pro

- with open ended wires M12
- high resistance PP materials
- Screw, Stainless Steel 1.4404 (V4A)

Approvals: **ECOLAB**

**Male**  
straight



**Male**  
90°



<b>1 Form</b>	<b>12041</b>	<b>12121</b>
Type	5-pole	5-pole
Circuit diagram		
Contact layout	<p>Male</p>	
<b>2 Cable Type</b>	<b>Jacket Color</b>	<b>Jacket Color</b>
Wire diameter 0.34 mm <sup>2</sup> TPE-S (UL) robots/C-tracks	pastel blue 339	pastel blue 339
<b>3 Cable Length</b>		
1.5 m	<b>0150</b>	
3.0 m	<b>0300</b>	
5.0 m	<b>0500</b>	
7.5 m	<b>0750</b>	
10.0 m	<b>1000</b>	
<b>Technical Data</b>		
Operating voltage	max. 125 V AC/DC	
Protection	IP65/IP68/IP69K inserted and tightened (EN 60529)	
Temperature range	-40...+105 °C, depending on cable quality	
<b>Article No.</b>		
The composition of your article number is explained on page 3.1.i	<p><b>7 0 2 4</b> - - - - - - - - - -</p>	
	<b>1 Form</b>	<b>2 Cable Type</b>
		<b>3 Cable Length</b>
<b>Notes</b>	Other versions on request. Further cable lengths on request.	



# PLUG CONNECTORS FOR FOOD & BEVERAGE

## M12 F&B Pro

- with open ended wires M12
- high resistance PP materials
- Screw, Stainless Steel 1.4404 (V4A)

Approvals: **ECOLAB**

Female  
straight



Female  
90°



1 Form	12181	12321
Type	3-pole	3-pole
Circuit diagram		
Contact layout		
2 Cable Type	Jacket Color	Jacket Color
Wire diameter 0.34 mm <sup>2</sup> TPE-S (UL) robots/C-tracks	pastel blue 315	pastel blue 315
3 Cable Length		
1.5 m	0150	
3.0 m	0300	
5.0 m	0500	
7.5 m	0750	
10.0 m	1000	
Technical Data		
Operating voltage	max. 250 V AC/DC	
Protection	IP65/IP68/IP69K inserted and tightened (EN 60529)	
Temperature range	-40...+105 °C, depending on cable quality	
Article No.		
The composition of your article number is explained on page 3.1.i	<div style="display: flex; align-items: center; justify-content: center; gap: 10px;"> <span style="border-bottom: 1px solid black; padding: 0 5px;">7</span> <span style="border-bottom: 1px solid black; padding: 0 5px;">0</span> <span style="border-bottom: 1px solid black; padding: 0 5px;">2</span> <span style="border-bottom: 1px solid black; padding: 0 5px;">4</span> <span style="font-size: 2em;">-</span> <span style="border-bottom: 1px dashed black; padding: 0 5px;"> </span> <span style="font-size: 2em;">-</span> <span style="border-bottom: 1px dashed black; padding: 0 5px;"> </span> <span style="border-bottom: 1px dashed black; padding: 0 5px;"> </span> </div>	
	<b>1</b> Form	<b>2</b> Cable Type
		<b>3</b> Cable Length
Notes	Other versions on request. Further cable lengths on request.	

# PLUG CONNECTORS FOR FOOD & BEVERAGE

## M12 F&B Pro

- with open ended wires M12
- high resistance PP materials
- Screw, Stainless Steel 1.4404 (V4A)

Approvals: **ECOLAB**

Female  
straight



Female  
90°



<b>1 Form</b>	<b>12221</b>	<b>12341</b>
Type	4-pole	4-pole
Circuit diagram		
Contact layout	<p>Female</p>	
<b>2 Cable Type</b>	<b>Jacket Color</b>	<b>Jacket Color</b>
Wire diameter 0.34 mm <sup>2</sup> TPE-S (UL) robots/C-tracks	pastel blue 321	pastel blue 321
<b>3 Cable Length</b>		
1.5 m	<b>0150</b>	
3.0 m	<b>0300</b>	
5.0 m	<b>0500</b>	
7.5 m	<b>0750</b>	
10.0 m	<b>1000</b>	
<b>Technical Data</b>		
Operating voltage	max. 250 V AC/DC	
Protection	IP65/IP68/IP69K inserted and tightened (EN 60529)	
Temperature range	-40...+105 °C, depending on cable quality	
<b>Article No.</b>		
The composition of your article number is explained on page 3.1.i	<p><b>7 0 2 4</b> - - - - - - - - - -</p>	
	<b>1 Form</b>	<b>2 Cable Type</b>
		<b>3 Cable Length</b>
<b>Notes</b>	Other versions on request. Further cable lengths on request.	

# PLUG CONNECTORS FOR FOOD & BEVERAGE

## M12 F&B Pro

- with open ended wires M12
- high resistance PP materials
- Screw, Stainless Steel 1.4404 (V4A)

Approvals: **ECOLAB**

**Female**  
straight



**Female**  
90°



<b>1 Form</b>	<b>12241</b>	<b>12361</b>
	Type 5-pole	Type 5-pole
Circuit diagram		
	Contact layout	<p>Female</p>
<b>2 Cable Type</b>	<b>Jacket Color</b>	<b>Jacket Color</b>
	Wire diameter 0.34 mm <sup>2</sup> TPE-S (UL) robots/C-tracks	pastel blue 339
<b>3 Cable Length</b>	1.5 m	<b>0150</b>
	3.0 m	<b>0300</b>
	5.0 m	<b>0500</b>
	7.5 m	<b>0750</b>
	10.0 m	<b>1000</b>
	<b>Technical Data</b>	
Operating voltage	max. 125 V AC/DC	
Protection	IP65/IP68/IP69K inserted and tightened (EN 60529)	
Temperature range	-40...+105 °C, depending on cable quality	
<b>Article No.</b>		
The composition of your article number is explained on page 3.1.i	<p><b>7 0 2 4</b> - - - - -</p>	
	<b>1 Form</b>	<b>2 Cable Type</b>
<b>Notes</b>	Other versions on request. Further cable lengths on request.	

# PLUG CONNECTORS FOR FOOD & BEVERAGE

## M12 F&B Pro

- with open ended wires M12
- high resistance PP materials
- Screw, Stainless Steel 1.4404 (V4A)

Approvals: **ECOLAB**

**Female**  
90° with LED

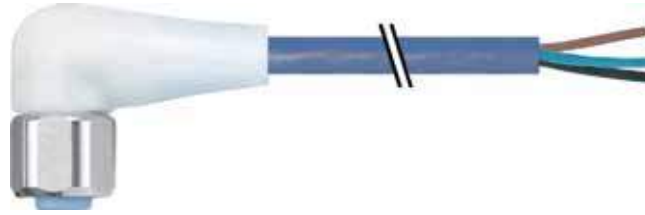

<b>1 Form</b>		<b>12441</b>	
Type	5-pole with 3 × LED (PNP) (NPN) on request		
Circuit diagram			
Contact layout	<p>Female</p>		
<b>2 Cable Type</b>		<b>Jacket Color</b>	
Wire diameter 0.34 mm <sup>2</sup> TPE-S (UL) robots/C-tracks	<p>pastel blue 339</p>		
<b>3 Cable Length</b>			
1.5 m	<b>0150</b>		
3.0 m	<b>0300</b>		
5.0 m	<b>0500</b>		
7.5 m	<b>0750</b>		
10.0 m	<b>1000</b>		
<b>Technical Data</b>			
Operating voltage	24 V DC ±25%		
Protection	IP65/IP68/IP69K inserted and tightened (EN 60529)		
Temperature range	-40...+85 °C, depending on cable quality		
<b>Article No.</b>			
The composition of your article number is explained on page 3.1.i	<p><b>7 0 2 4</b> - <b>1 2 4 4 1</b> - _ _ _ _</p>		
	<b>1 Form</b>	<b>2 Cable Type</b>	<b>3 Cable Length</b>
<b>Notes</b>	Other versions on request. Further cable lengths on request.		

# PLUG CONNECTORS FOR FOOD & BEVERAGE

## M12 F&B Pro

- Connection cables M12 - M12
- high resistance PP materials
- Screw, Stainless Steel 1.4404 (V4A)

Approvals: **ECOLAB**

### Male

straight

### Female

straight



1 Form	40001	40021
Type	3-pole	4-pole
Circuit diagram		
Contact layout		
2 Cable Type	Jacket Color	Jacket Color
Wire diameter 0.34 mm <sup>2</sup> TPE-S (UL) robots/C-tracks	pastel blue 315	pastel blue 321
3 Cable Length		
0.3 m	0030	
0.6 m	0060	
1.0 m	0100	
1.5 m	0150	
2.0 m	0200	
Technical Data		
Operating voltage	max. 250 V AC/DC	
Protection	IP65/IP68/IP69K inserted and tightened (EN 60529)	
Temperature range	-40...+105 °C, depending on cable quality	
Article No.		
The composition of your article number is explained on page 3.1.i	<div style="display: flex; justify-content: space-around; align-items: center;"> <span style="border-bottom: 1px solid black; padding: 0 5px;">7</span> <span style="border-bottom: 1px solid black; padding: 0 5px;">0</span> <span style="border-bottom: 1px solid black; padding: 0 5px;">2</span> <span style="border-bottom: 1px solid black; padding: 0 5px;">4</span> <span style="font-size: 2em;">-</span> <span style="border-bottom: 1px solid black; padding: 0 5px;"> </span> <span style="font-size: 2em;">-</span> <span style="border-bottom: 1px solid black; padding: 0 5px;"> </span> <span style="border-bottom: 1px solid black; padding: 0 5px;"> </span> </div>	
	<b>1</b> Form	<b>2</b> Cable Type
		<b>3</b> Cable Length
Notes	Other versions on request. Further cable lengths on request.	

Plug Connectors for Food & Beverage

# PLUG CONNECTORS FOR FOOD & BEVERAGE

## M12 F&B Pro

- Connection cables M12 - M12
- high resistance PP materials
- Screw, Stainless Steel 1.4404 (V4A)

Approvals: **ECOLAB**

**Male**  
straight

**Female**  
straight

**Male**  
90°

**Female**  
90°



<b>1 Form</b>	<b>40041</b>	<b>40281</b>
Type	5-pole	5-pole
Circuit diagram		
Contact layout		
<b>2 Cable Type</b>	<b>Jacket Color</b>	<b>Jacket Color</b>
Wire diameter 0.34 mm <sup>2</sup> TPE-S (UL) robots/C-tracks	pastel blue 339	pastel blue 339
<b>3 Cable Length</b>		
0.3 m	0030	
0.6 m	0060	
1.0 m	0100	
1.5 m	0150	
2.0 m	0200	
<b>Technical Data</b>		
Operating voltage	max. 125 V AC/DC	
Protection	IP65/IP68/IP69K inserted and tightened (EN 60529)	
Temperature range	-40...+105 °C, depending on cable quality	
<b>Article No.</b>		
The composition of your article number is explained on page 3.1.i	<b>7 0 2 4</b> - - - - - - - - - -	
	<b>1 Form</b>	<b>2 Cable Type</b>
		<b>3 Cable Length</b>
<b>Notes</b>	Other versions on request. Further cable lengths on request.	

# PLUG CONNECTORS FOR FOOD & BEVERAGE

with open ended wires M12

– Stainless Steel 1.4404 (V4A)

– Profile gasket



Approvals:     
 \* only for products with UL/CSA approved cable

Female  
straight



Female  
90°

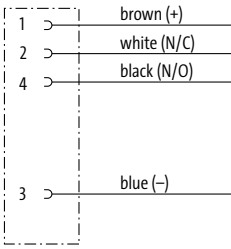

1 Form		12221	12341
Type		4-pole	4-pole
Circuit diagram			
Contact layout	<p>Female</p> 		
2 Cable Type		Jacket Color	Jacket Color
Wire diameter 0.34 mm <sup>2</sup> PVC (UL/CSA)		gray 214	gray 214
3 Cable Length			
1.5 m		0150	
3.0 m		0300	
5.0 m		0500	
7.5 m		0750	
10.0 m		1000	
Technical Data			
Operating voltage		max. 250 V AC/DC	
Protection		IP65, IP68 inserted and tightened (EN 60529)	
Temperature range		-25...+85 °C, depending on cable quality	
Article No.			
The composition of your article number is explained on page 3.1.i		<u>7</u> <u>0</u> <u>1</u> <u>4</u> - - - - - - - - - -	- - - - -
	<b>1</b> Form	<b>2</b> Cable Type	<b>3</b> Cable Length
Notes		Other versions on request. Further cable lengths on request.	

Plug Connectors for Food & Beverage

# PLUG CONNECTORS FOR FOOD & BEVERAGE

with open ended wires M12

– Stainless Steel 1.4404 (V4A)

– Profile gasket

Approvals:     
\* only for products with UL/CSA approved cable

**Female**  
90° with LED

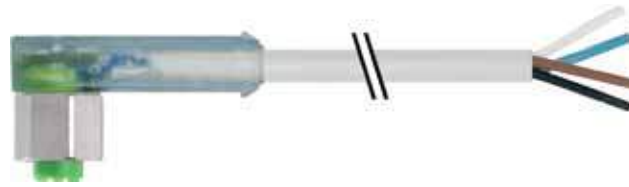

<b>1 Form</b>		<b>12421</b>	
Type	4-pole with 3 × LED (PNP) (NPN) on request		
Circuit diagram			
Contact layout	Female 		
<b>2 Cable Type</b>		<b>Jacket Color</b>	
Wire diameter 0.34 mm <sup>2</sup> PVC (UL/CSA)	gray 214		
<b>3 Cable Length</b>			
1.5 m	0150		
3.0 m	0300		
5.0 m	0500		
7.5 m	0750		
10.0 m	1000		
<b>Technical Data</b>			
Operating voltage	24 V DC ±25%		
Protection	IP65, IP68 inserted and tightened (EN 60529)		
Temperature range	-25...+85 °C, depending on cable quality		
<b>Article No.</b>			
The composition of your article number is explained on page 3.1.i	7 0 1 4 - 1 2 4 2 1 - - - - -		
	<b>1 Form</b>	<b>2 Cable Type</b>	<b>3 Cable Length</b>
<b>Notes</b>	Other versions on request. Further cable lengths on request.		



# PLUG CONNECTORS FOR FOOD & BEVERAGE

with open ended wires M12

– Stainless Steel 1.4404 (V4A)

– Profile gasket



Approvals:     
\* only for products with UL/CSA approved cable

Female  
straight

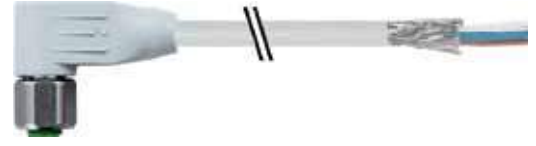

Female  
90°

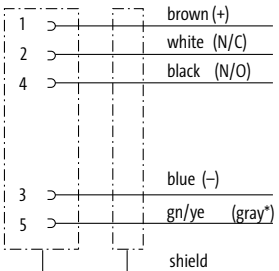

1 Form		13221		13281	
Type	5-pole, shielded			5-pole, shielded	
Circuit diagram	 <p>(* for cable type 203)</p>				
Contact layout	<p>Female</p> 				
2 Cable Type		Jacket Color		Jacket Color	
Wire diameter 0.34 mm <sup>2</sup> PVC (UL/CSA)		gray 202 (203)	black 602 (603)	gray 202 (203)	black 602 (603)
3 Cable Length					
1.5 m	0150				
3.0 m	0300				
5.0 m	0500				
7.5 m	0750				
10.0 m	1000				
Technical Data					
Operating voltage	max. 60 V AC/DC				
Protection	IP65, IP68 inserted and tightened (EN 60529)				
Temperature range	-25...+85 °C, depending on cable quality				
Article No.					
The composition of your article number is explained on page 3.1.i	<p><u>7</u> <u>0</u> <u>1</u> <u>4</u> - - - - - - - - - -</p>				
	<b>1</b> Form	<b>2</b> Cable Type	<b>3</b> Cable Length		
Notes		Other versions on request. Further cable lengths on request.			

Plug Connectors for Food & Beverage

# PLUG CONNECTORS FOR FOOD & BEVERAGE

Connection cables M12 - M12

– Stainless Steel 1.4404 (V4A)

– Profile gasket

Male  
straight

Female  
straight

Male  
straight

Female  
90°



Approvals: **ECOLAB**   
\* only for products with UL/CSA approved cable

1 Form		40021	40121
Type		4-pole	4-pole
Circuit diagram			
Contact layout			
2 Cable Type		Jacket Color	Jacket Color
Wire diameter 0.34 mm <sup>2</sup> PVC (UL/CSA)		gray 214	gray 214
3 Cable Length			
0.3 m		0030	
0.6 m		0060	
1.0 m		0100	
1.5 m		0150	
2.0 m		0200	
Technical Data			
Operating voltage		max. 250 V AC/DC	
Protection		IP65, IP68 inserted and tightened (EN 60529)	
Temperature range		-25...+85 °C, depending on cable quality	
Article No.			
The composition of your article number is explained on page 3.1.i		<div style="display: flex; justify-content: space-around; align-items: center;"> <span style="border-bottom: 1px solid black; padding: 0 5px;">7</span> <span style="border-bottom: 1px solid black; padding: 0 5px;">0</span> <span style="border-bottom: 1px solid black; padding: 0 5px;">1</span> <span style="border-bottom: 1px solid black; padding: 0 5px;">4</span> <span style="font-size: 2em;">-</span> <span style="border-bottom: 1px dashed black; width: 100px;"></span> <span style="font-size: 2em;">-</span> <span style="border-bottom: 1px dashed black; width: 100px;"></span> </div>	
		<b>1</b> Form	<b>2</b> Cable Type
		<b>3</b> Cable Length	
Notes		Other versions on request. Further cable lengths on request.	

# PLUG CONNECTORS FOR FOOD & BEVERAGE

## Connection cables M12 - M12

- Stainless Steel 1.4404 (V4A)
- Profile gasket

Approvals:     
 \* only for products with UL/CSA approved cable

### Male

straight

### Female

90° with LED



<b>1 Form</b>	<b>Form</b>	<b>40341</b>		
	Type	4-pole with 3 x LED (PNP) (NPN) on request		
<b>Circuit diagram</b>	Circuit diagram			
	Contact layout			
<b>2 Cable Type</b>	<b>Cable Type</b>	<b>Jacket Color</b>		
	Wire diameter 0.34 mm <sup>2</sup> PVC (UL/CSA)	gray	214	
<b>3 Cable Length</b>	<b>Cable Length</b>			
	0.3 m	<b>0030</b>		
	0.6 m	<b>0060</b>		
	1.0 m	<b>0100</b>		
	1.5 m	<b>0150</b>		
2.0 m	<b>0200</b>			
<b>Technical Data</b>	<b>Technical Data</b>			
	Operating voltage	24 V DC ±25%		
	Protection	IP65, IP68 inserted and tightened (EN 60529)		
Temperature range	-25...+85 °C, depending on cable quality			
<b>Article No.</b>	<b>Article No.</b>			
	The composition of your article number is explained on page 3.1.i	<u>7</u> <u>0</u> <u>1</u> <u>4</u> - <u>4</u> <u>0</u> <u>3</u> <u>4</u> <u>1</u> - _ _ _ _		
		<b>1 Form</b>	<b>2 Cable Type</b>	<b>3 Cable Length</b>
<b>Notes</b>	Other versions on request. Further cable lengths on request.			

Plug Connectors for Food & Beverage

# PLUG CONNECTORS FOR FOOD & BEVERAGE

With open ended wires

- M12-Steel
- Stainless Steel 1.4404 (V4A)
- Permanently IP69K

Approvals:  

\* only for products with UL/CSA approved cable

**Male**  
straight



**Male**  
90°

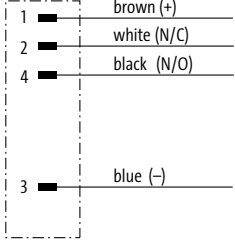
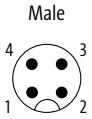

<b>1 Form</b>	<b>12021</b>	<b>12101</b>
Type	4-pole	4-pole
Circuit diagram		
Contact layout		
<b>2 Cable Type</b>	<b>Jacket Color</b>	<b>Jacket Color</b>
Wire diameter 0.34 mm <sup>2</sup>	gray	gray
PVC (UL/CSA)	214	214
TPE-S	336	336
<b>3 Cable Length</b>		
1.5 m	<b>0150</b>	
3.0 m	<b>0300</b>	
5.0 m	<b>0500</b>	
7.5 m	<b>0750</b>	
10.0 m	<b>1000</b>	
<b>Technical Data</b>		
Operating voltage	max. 32 V AC/DC	
Protection	IP68, IP69K inserted and tightened (EN 60529)	
Temperature range	-40...+85 °C, depending on cable quality	
<b>Article No.</b>		
The composition of your article number is explained on page 3.1.i	<p><b>7 0 4 4</b> - - - - - - - - - -</p>	
	<b>1 Form</b>	<b>2 Cable Type</b>
		<b>3 Cable Length</b>
<b>Notes</b>	Other versions on request. Further cable lengths on request.	

# PLUG CONNECTORS FOR FOOD & BEVERAGE

With open ended wires

- M12-Steel
- Stainless Steel 1.4404 (V4A)
- Permanently IP69K

Approvals: **ECOLAB** **CSF**<sup>\*</sup>  
C US

\* only for products with UL/CSA approved cable

Female  
straight



1 Form		12221	12241
Type		4-pole	5-pole
Circuit diagram			<p>(* for cable type 219)</p>
Contact layout		<p>Female</p>	<p>Female</p>
2 Cable Type		Jacket Color	Jacket Color
Wire diameter 0.34 mm <sup>2</sup>		gray	gray      black
PVC (UL/CSA)		214	215      615
TPE-S		336	
3 Cable Length			
1.5 m		0150	
3.0 m		0300	
5.0 m		0500	
7.5 m		0750	
10.0 m		1000	
Technical Data			
Operating voltage		max. 32 V AC/DC	
Protection		IP68, IP69K inserted and tightened (EN 60529)	
Temperature range		-40...+85 °C, depending on cable quality	
Article No.			
The composition of your article number is explained on page 3.1.i		<u>7</u> <u>0</u> <u>4</u> <u>4</u> - - - - - - - - - -	- - - - -
		<b>1</b> Form	<b>2</b> Cable Type <b>3</b> Cable Length
Notes		Other versions on request. Further cable lengths on request.	

Plug Connectors for Food & Beverage

# PLUG CONNECTORS FOR FOOD & BEVERAGE

With open ended wires



- M12-Steel
- Stainless Steel 1.4404 (V4A)
- Permanently IP69K

Approvals: 

\* only for products with UL/CSA approved cable

Female  
90°

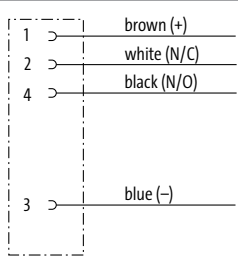

<b>1 Form</b>	<b>12341</b>	
Type	4-pole	
Circuit diagram		
Contact layout	<p>Female</p> 	
<b>2 Cable Type</b>	<b>Jacket Color</b>	
Wire diameter 0.34 mm <sup>2</sup>	gray	
PVC (UL/CSA)	214	
TPE-S	336	
<b>3 Cable Length</b>		
1.5 m	0150	
3.0 m	0300	
5.0 m	0500	
7.5 m	0750	
10.0 m	1000	
<b>Technical Data</b>		
Operating voltage	max. 32 V AC/DC	
Protection	IP68, IP69K inserted and tightened (EN 60529)	
Temperature range	-40...+85 °C, depending on cable quality	
<b>Article No.</b>		
The composition of your article number is explained on page 3.1.i	<p><b>7 0 4 4</b> - <b>1 2 3 4 1</b> -      -      -</p>	
	<b>1 Form</b>	<b>2 Cable Type</b>
		<b>3 Cable Length</b>
<b>Notes</b>	Other versions on request. Further cable lengths on request.	

# PLUG CONNECTORS FOR FOOD & BEVERAGE

With open ended wires



- M12-Steel
- Stainless Steel 1.4404 (V4A)
- Permanently IP69K

Approvals: 

\* only for products with UL/CSA approved cable

**Female**  
straight, with LED

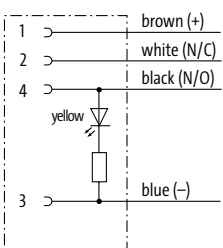

<b>1 Form</b>		<b>12292</b>	
Type	4-pole with 1 × LED (PNP) (NPN) on request		
Circuit diagram			
Contact layout	Female 		
<b>2 Cable Type</b>		<b>Jacket Color</b>	
Wire diameter 0.34 mm <sup>2</sup>		gray	
PVC (UL/CSA)		214	
TPE-S		336	
<b>3 Cable Length</b>			
1.5 m		0150	
3.0 m		0300	
5.0 m		0500	
7.5 m		0750	
10.0 m		1000	
<b>Technical Data</b>			
Operating voltage	24 V AC/DC ±25%		
Protection	IP68, IP69K inserted and tightened (EN 60529)		
Temperature range	-40...+85 °C, depending on cable quality		
<b>Article No.</b>			
The composition of your article number is explained on page 3.1.i	<u>7 0 4 4</u> - <u>1 2 2 9 2</u> - _ _ _ _		
	<b>1 Form</b>	<b>2 Cable Type</b>	<b>3 Cable Length</b>
<b>Notes</b>		Other versions on request. Further cable lengths on request.	

Plug Connectors for Food & Beverage

# PLUG CONNECTORS FOR FOOD & BEVERAGE

## Connection cables

- M12-Steel
- Stainless Steel 1.4404 (V4A)
- Permanently IP69K

Approvals:  

\* only for products with UL/CSA approved cable

**Male**  
straight

**Female**  
straight

**Male**  
straight

**Female**  
90°



<b>1 Form</b>	<b>40021</b>	<b>40121</b>
Type	4-pole	4-pole
Circuit diagram		
Contact layout		
<b>2 Cable Type</b>	<b>Jacket Color</b>	<b>Jacket Color</b>
Wire diameter 0.34 mm <sup>2</sup>	gray	gray
PVC (UL/CSA)	214	214
TPE-S	336	336
<b>3 Cable Length</b>		
0.3 m	0030	
0.6 m	0060	
1.0 m	0100	
1.5 m	0150	
2.0 m	0200	
<b>Technical Data</b>		
Operating voltage	max. 32 V AC/DC	
Protection	IP68, IP69K inserted and tightened (EN 60529)	
Temperature range	-40...+85 °C, depending on cable quality	
<b>Article No.</b>		
The composition of your article number is explained on page 3.1.i	<div style="display: flex; justify-content: space-around; align-items: center;"> <span style="border-bottom: 1px solid black; padding: 0 5px;">7</span> <span style="border-bottom: 1px solid black; padding: 0 5px;">0</span> <span style="border-bottom: 1px solid black; padding: 0 5px;">4</span> <span style="border-bottom: 1px solid black; padding: 0 5px;">4</span> <span style="font-size: 2em;">-</span> <span style="border-bottom: 1px dashed black; width: 50px;"></span> <span style="font-size: 2em;">-</span> <span style="border-bottom: 1px dashed black; width: 50px;"></span> <span style="border-bottom: 1px dashed black; width: 50px;"></span> </div>	
	<b>1 Form</b>	<b>2 Cable Type</b>
		<b>3 Cable Length</b>
<b>Notes</b>	Other versions on request. Further cable lengths on request.	



# PLUG CONNECTORS FOR FOOD & BEVERAGE

## Connection cables

- M12-Steel
- Stainless Steel 1.4404 (V4A)
- Permanently IP69K

Approvals: 

\* only for products with UL/CSA approved cable

**Male**  
90°

**Female**  
straight



**Male**  
90°

**Female**  
90°



<b>1 Form</b>	<b>40201</b>	<b>40261</b>	
	Type 4-pole	Type 4-pole	
Circuit diagram			
	Contact layout		
<b>2 Cable Type</b>	<b>Jacket Color</b>	<b>Jacket Color</b>	
	Wire diameter 0.34 mm <sup>2</sup>	gray	gray
	PVC (UL/CSA)	214	214
TPE-S	336	336	
<b>3 Cable Length</b>	0.3 m	0030	
	0.6 m	0060	
	1.0 m	0100	
	1.5 m	0150	
	2.0 m	0200	
<b>Technical Data</b>			
Operating voltage	max. 32 V AC/DC		
Protection	IP68, IP69K inserted and tightened (EN 60529)		
Temperature range	-40...+85 °C, depending on cable quality		
<b>Article No.</b>			
The composition of your article number is explained on page 3.1.i	<div style="display: flex; justify-content: space-around; align-items: center;"> <span style="border-bottom: 1px solid black; padding: 0 5px;">7</span> <span style="border-bottom: 1px solid black; padding: 0 5px;">0</span> <span style="border-bottom: 1px solid black; padding: 0 5px;">4</span> <span style="border-bottom: 1px solid black; padding: 0 5px;">4</span> <span style="font-size: 2em;">-</span> <span style="border-bottom: 1px dashed black; padding: 0 5px;"> </span> <span style="font-size: 2em;">-</span> <span style="border-bottom: 1px dashed black; padding: 0 5px;"> </span> <span style="border-bottom: 1px dashed black; padding: 0 5px;"> </span> </div>		
	<b>1 Form</b>	<b>2 Cable Type</b>	
		<b>3 Cable Length</b>	
<b>Notes</b>	Other versions on request. Further cable lengths on request.		

# PLUG CONNECTORS FOR FOOD & BEVERAGE

## Connection cables

- M12-Steel
- Stainless Steel 1.4404 (V4A)
- Permanently IP69K

Approvals:  

\* only for products with UL/CSA approved cable

## Male

straight







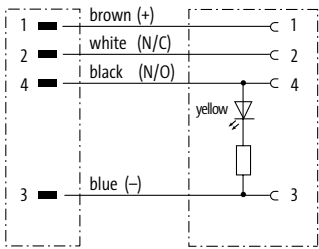
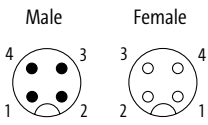



## Female

straight, with LED



<b>1 Form</b>		<b>4 0 3 1 2</b>	
Type	4-pole with 1 × LED (PNP) (NPN) on request		
Circuit diagram			
Contact layout			
<b>2 Cable Type</b>		<b>Jacket Color</b>	
Wire diameter 0.34 mm <sup>2</sup>		gray	
PVC (UL/CSA)		214	
TPE-S		336	
<b>3 Cable Length</b>			
0.3 m		0030	
0.6 m		0060	
1.0 m		0100	
1.5 m		0150	
2.0 m		0200	
<b>Technical Data</b>			
Operating voltage	24 V AC/DC ±25%		
Protection	IP68, IP69K inserted and tightened (EN 60529)		
Temperature range	-40...+85 °C, depending on cable quality		
<b>Article No.</b>			
The composition of your article number is explained on page 3.1.i	<u>7 0 4 4</u> - <u>4 0 3 1 2</u> - _____		
	<b>1 Form</b>	<b>2 Cable Type</b>	<b>3 Cable Length</b>
<b>Notes</b>		Other versions on request. Further cable lengths on request.	

## PLUG CONNECTORS FOR FOOD & BEVERAGE

Labeling accessories			Art-No.
	<b>Slip-on cable sleeve</b> for ACS label plates (4 × 18 mm)	Cable diameter (4...6.5 mm)	7000-99004-0000000
	<b>Snap-on cable sleeve</b> for ACS label plates (4 × 18 mm)	Cable diameter (4.2...5.6 mm)	7000-99005-0000000
	for ACS label plates (4 × 18 mm)	Cable diameter (5...7 mm)	7000-99006-0000000
	<b>ACS label plate</b> for self marking (4 × 18 mm)		7000-99002-0000000
	<b>Colored ring M8/M12</b> sandy yellow	for unshielded molding	7000-99301-V011002
	zinc yellow	for unshielded molding	7000-99301-V011018
	redorange	for unshielded molding	7000-99301-V012008
	red	for unshielded molding	7000-99301-V013020
	violet	for unshielded molding	7000-99301-V014003
	purple	for unshielded molding	7000-99301-V014006
	blue	for unshielded molding	7000-99301-V015005
	green	for unshielded molding	7000-99301-V016018
	gray	for unshielded molding	7000-99301-V017035
	white	for unshielded molding	7000-99301-V019003
	black	for unshielded molding	7000-99301-V019004
Mounting accessories			Art-No.
	<b>Torque wrench set</b> M8 (0.4 Nm, SW9)	M8 data connectors	7000-99101-0000000
	<b>Torque wrench set</b> M12 (0.6 Nm, SW13)	M12 data connector molded (standard)	7000-99102-0000000
	<b>Torque wrench set</b> M12 (0.6 Nm, SW14)		7000-99107-0000000
	<b>Torque wrench</b> M12 (0.6 Nm, SW14)	M12 data connector moulded (Xtreme)	7000-99108-0000000
	<b>Torque wrench</b> M12 (0.6 Nm, SW17)	M12 field-wireable (IDC terminal)	7000-99094-0000000
	<b>Torque wrench</b> M12 (0.6 Nm, SW18)	M12 field-wireable via (screw terminals)	7000-99103-0000000

# PLUG CONNECTORS FOR FOOD & BEVERAGE

Mounting accessories			Art-No.
	<b>Hold clip M12</b> Plastic		7000-99045-0000000
End fitting accessories			Art-No.
	<b>Tube adapter</b> snap-in for corrugated tube (size 13mm)	Cable diameter (4...7 mm)	7000-99081-0000000
Connection accessories			Art-No.
	<b>Universal holder</b> modular	M8 M12	7000-99801-0000000
	<b>Universal holder</b> modular	M12 Y-connector M12	7000-99811-0000000



# MOBILE APPLICATIONS FOR ROUGH APPLICATIONS

- Robust
- Resistant
- Sealed

## KEEP YOUR MOBILE EQUIPMENT GOING STRONG WITH OUR FULLY POTTED CONNECTORS

Many leading mobile hydraulic valve manufacturers are currently updating their connection concepts. Instead of the old-fashioned (rectangular) valve connectors compliant with DIN EN 175301-803, they are increasingly recommending alternatives with Junior Power Timer, Deutsch or SuperSeal connectors.

### MDC – MURRELEKTRONIK DEUTSCH CONNECTOR

Murrelektronik MDC connectors are pre-wired valve connectors, which are 100% compatible with Deutsch DT connectors. Even though the cables are connected to the housing and fully sealed, the connector is as compact as possible.

### MSC – MURRELEKTRONIK SUPERSEAL CONNECTOR

Murrelektronik MSC cordsets are pre-wired valve connectors that are 100% compatible with the size 1.5 SuperSeal connectors. Even though the cables are connected to the housing and fully sealed, the connector is as compact as possible.

## With Open Ended Wires



#### AMP Junior Power Timer

- Female straight
- Female 90°

Page 3.8.1



#### Deutsch MDC

- Male straight
- Y connector male
- Female straight

Page 3.8.3



#### SuperSeal MSC1.5

- Male straight
- Female straight

Page 3.8.8

# MOBILE APPLICATIONS

## Xtreme - Mobile Applications

- with open ended wires
- compatible with:
- AMP Junior Power Timer

Female  
straight



1 Form	70001	70021	70061
Type	max. 230 V AC/DC without components	12...24 V AC/DC LED	12...24 V AC/DC LED and VDR
Circuit diagram	<p>* for cable type (740)</p>	<p>* for cable type (740)</p>	<p>* for cable type (740)</p>
Contact layout			
2 Cable Type	Jacket Color	Jacket Color	Jacket Color
Wire diameter 0.75 mm <sup>2</sup> PUR/PVC	black 750	black 750	black 750
PUR (UL/CSA), robots/C-tracks	754	754	754
Wire diameter 0.5 mm <sup>2</sup> PUR, C-tracks	740	740	740
3 Cable Length			
1.5 m	0150		
3.0 m	0300		
5.0 m	0500		
7.5 m	0750		
10.0 m	1000		
Technical Data			
Operating voltage	max. 230 V AC/DC	12...24 V AC/DC	
Protection	IP65 inserted and tightened		
Temperature range	-25...+85 °C, depending on cable quality		
Article No.			
The composition of your article number is explained on page 3.1.i	<div style="display: flex; justify-content: space-around; align-items: center;"> <span style="border: 1px solid black; padding: 2px 5px;">7</span> <span style="border: 1px solid black; padding: 2px 5px;">0</span> <span style="border: 1px solid black; padding: 2px 5px;">7</span> <span style="border: 1px solid black; padding: 2px 5px;">2</span> <span style="font-size: 2em;">-</span> <span style="border: 1px solid black; padding: 2px 5px;"> </span> <span style="font-size: 2em;">-</span> <span style="border: 1px solid black; padding: 2px 5px;"> </span> <span style="border: 1px solid black; padding: 2px 5px;"> </span> <span style="border: 1px solid black; padding: 2px 5px;"> </span> </div>		
	<b>1</b> Form	<b>2</b> Cable Type	<b>3</b> Cable Length
Notes	Other versions on request. Differing cable lengths up to 2 m can be ordered in 0.2 m steps, from 2 m on in 0.5 m steps.		

Mobile Applications

# MOBILE APPLICATIONS

## Xtreme - Mobile Applications

- with open ended wires
- compatible with:
- AMP Junior Power Timer

Female  
90°



1 Form	70301	70321	70361
Type	max. 230 V AC/DC without components	12...24 V AC/DC LED	12...24 V AC/DC LED and VDR
Circuit diagram			
Contact layout			
2 Cable Type	Jacket Color	Jacket Color	Jacket Color
Wire diameter 0.75 mm <sup>2</sup>	black	black	black
PUR/PVC	750	750	750
PUR (UL/CSA), robots/C-tracks	754	754	754
Wire diameter 0.5 mm <sup>2</sup>			
PUR, C-tracks	740	740	740
3 Cable Length			
1.5 m	0150		
3.0 m	0300		
5.0 m	0500		
7.5 m	0750		
10.0 m	1000		
Technical Data			
Operating voltage	max. 230 V AC/DC	12...24 V AC/DC	
Protection	IP65 inserted and tightened		
Temperature range	-25...+85 °C, depending on cable quality		
Article No.			
The composition of your article number is explained on page 3.1.i	<div style="display: flex; justify-content: space-around; align-items: center;"> <span style="border-bottom: 1px solid black; padding: 0 5px;">7</span> <span style="border-bottom: 1px solid black; padding: 0 5px;">0</span> <span style="border-bottom: 1px solid black; padding: 0 5px;">7</span> <span style="border-bottom: 1px solid black; padding: 0 5px;">2</span> <span style="font-size: 2em;">-</span> <span style="border-bottom: 1px solid black; padding: 0 5px;"> </span> <span style="font-size: 2em;">-</span> <span style="border-bottom: 1px solid black; padding: 0 5px;"> </span> <span style="border-bottom: 1px solid black; padding: 0 5px;"> </span> <span style="border-bottom: 1px solid black; padding: 0 5px;"> </span> </div>		
	<b>1</b>	<b>2</b>	<b>3</b>
	Form	Cable Type	Cable Length
Notes	Other versions on request. Differing cable lengths up to 2 m can be ordered in 0.2 m steps, from 2 m on in 0.5 m steps.		

# MOBILE APPLICATIONS

## Xtreme - Mobile Applications

- with open ended wires
- compatible with:
- Deutsch DT 06

### Deutsch MDC 06-2S

Male straight



### Deutsch MDC 06-3S

Male straight



<b>1 Form</b>	<b>72011</b>	<b>72081</b>									
	Type 2-pole 12...230 V AC/DC without components	Type 3-pole 6...230 V AC/DC without components									
Circuit diagram											
Contact layout	<p>Male female contacts</p>	<p>Male female contacts</p>									
<b>2 Cable Type</b>	<b>Jacket Color</b>	<b>Jacket Color</b>									
	Wire diameter 0.75 mm <sup>2</sup> PUR/PVC PUR (UL/CSA), robots/Ctracks	<table border="1"> <tr> <td>black</td> <td>yellow</td> </tr> <tr> <td>750</td> <td></td> </tr> <tr> <td>754</td> <td>145</td> </tr> </table>	black	yellow	750		754	145	<table border="1"> <tr> <td>black</td> </tr> <tr> <td>564</td> </tr> </table>	black	564
	black	yellow									
750											
754	145										
black											
564											
<b>3 Cable Length</b>											
1.5 m	0150										
3.0 m	0300										
5.0 m	0500										
7.5 m	0750										
10.0 m	1000										
<b>Technical Data</b>											
Operating voltage	12...230 V AC/DC	6...230 V AC/DC									
Protection	IP68 inserted and tightened										
Temperature range	-25...+85 °C, depending on cable quality										
<b>Article No.</b>											
The composition of your article number is explained on page 3.1.i	<table border="1"> <tr> <td><u>7</u></td> <td><u>0</u></td> <td><u>7</u></td> <td><u>2</u></td> <td>-</td> <td>---</td> <td>-</td> <td>---</td> <td>---</td> </tr> </table>		<u>7</u>	<u>0</u>	<u>7</u>	<u>2</u>	-	---	-	---	---
<u>7</u>	<u>0</u>	<u>7</u>	<u>2</u>	-	---	-	---	---			
	<b>1 Form</b>	<b>2 Cable Type</b>	<b>3 Cable Length</b>								
<b>Notes</b>	Other versions on request. Differing cable lengths up to 2 m can be ordered in 0.2 m steps, from 2 m on in 0.5 m steps.										



# MOBILE APPLICATIONS

## Xtreme - Mobile Applications

- with open ended wires
- compatible with:
- Deutsch DT 06

### Deutsch MDC 06-4S

Male straight



### Deutsch MDC 06-6S

Male straight



<b>1 Form</b>	<b>72161</b>	<b>72221</b>
	<p>Type</p> <p>4-pole</p> <p>6...230 V AC/DC</p> <p>without components</p>	<p>6-pole</p> <p>6...230 V AC/DC</p> <p>without components</p>
<b>Circuit diagram</b>		
<b>Contact layout</b>	<p>Male female contacts</p>	<p>Male female contacts</p>
<b>2 Cable Type</b>	<b>Jacket Color</b>	<b>Jacket Color</b>
<p>Wire diameter 0.75 mm<sup>2</sup></p> <p>PUR (UL/CSA), robots/Ctracks</p>	<p><b>black</b></p> <p><b>569</b></p>	<p><b>black</b></p> <p><b>572</b></p>
<b>3 Cable Length</b>		
1.5 m	<b>0150</b>	
3.0 m	<b>0300</b>	
5.0 m	<b>0500</b>	
7.5 m	<b>0750</b>	
10.0 m	<b>1000</b>	
<b>Technical Data</b>		
Operating voltage	6...230 V AC/DC	
Protection	IP68 inserted and tightened	
Temperature range	-25...+85 °C, depending on cable quality	
<b>Article No.</b>		
The composition of your article number is explained on page 3.1.i	<p><u>7 0 7 2</u> - - - - - - - - - -</p>	
	<b>1 Form</b>	<b>2 Cable Type</b>
		<b>3 Cable Length</b>
<b>Notes</b>	Other versions on request. Differing cable lengths up to 2 m can be ordered in 0.2 m steps, from 2 m on in 0.5 m steps.	

Mobile Applications

# MOBILE APPLICATIONS

## Xtreme - Mobile Applications

- with open ended wires
- compatible with:
- Deutsch DT 06

## Deutsch MDC 06-4S

Y connector  
Male



<b>1 Form</b>		<b>72191</b>	
Type	4-/2-pole 6...230 V AC/DC without components		
Circuit diagram			
Contact layout	<p>Male female contacts</p>		
<b>2 Cable Type</b>		<b>Jacket Color</b>	
Wire diameter 0.75 mm <sup>2</sup> PUR (UL/CSA), robots/Ctracks	black 754	yellow 145	
<b>3 Cable Length</b>			
1.5 m	0150		
3.0 m	0300		
5.0 m	0500		
7.5 m	0750		
10.0 m	1000		
<b>Technical Data</b>			
Operating voltage	6...230 V AC/DC		
Protection	IP68 inserted and tightened		
Temperature range	-25...+85 °C, depending on cable quality		
<b>Article No.</b>			
The composition of your article number is explained on page 3.1.i	<p><u>7 0 7 2</u> - <u>7 2 1 9 1</u> - _ _ _ _</p>		
	<b>1 Form</b>	<b>2 Cable Type</b>	<b>3 Cable Length</b>
<b>Notes</b>	Other versions on request. Differing cable lengths up to 2 m can be ordered in 0.2 m steps, from 2 m on in 0.5 m steps.		

# MOBILE APPLICATIONS

## Xtreme - Mobile Applications

- with open ended wires
- compatible with:
- Deutsch DT 06

### Deutsch MDC 04-2P

Female straight



### Deutsch MDC 04-3P

Female straight



## 1 Form

### 72301

### 72381

Type	2-pole 6...230 V AC/DC without components	3-pole 6...230 V AC/DC without components
Circuit diagram		
Contact layout	<p>Female male contacts</p>	<p>Female male contacts</p>

## 2 Cable Type

### Jacket Color

### Jacket Color

Wire diameter 0.75 mm <sup>2</sup>	black	yellow	black
PUR/PVC	750		
PUR (UL/CSA), robots/Ctracks	754	145	564

## 3 Cable Length

1.5 m	0150
3.0 m	0300
5.0 m	0500
7.5 m	0750
10.0 m	1000

## Technical Data

Operating voltage	6...230 V AC/DC
Protection	IP68 inserted and tightened
Temperature range	-25...+85 °C, depending on cable quality

## Article No.

The composition of your article number is explained on page 3.1.i

7 0 7 2 - - - - -

**1** Form

**2** Cable Type

**3** Cable Length

## Notes

Other versions on request. Differing cable lengths up to 2 m can be ordered in 0.2 m steps, from 2 m on in 0.5 m steps.

# MOBILE APPLICATIONS

## Xtreme - Mobile Applications

- with open ended wires
- compatible with:
- Deutsch DT 06

### Deutsch MDC 04-4P

Female straight



### Deutsch MDC 04-6P

Female straight



1 Form		72461	72521
Type	4-pole	6-pole	6-pole
	6...230 V AC/DC	6...230 V AC/DC	6...230 V AC/DC
	without components	without components	without components
Circuit diagram			
Contact layout	Female male contacts 	Female male contacts 	
2 Cable Type		Jacket Color	
Wire diameter 0.75 mm <sup>2</sup> PUR (UL/CSA), robots/Ctracks		black 569	black 572
3 Cable Length			
1.5 m		0150	
3.0 m		0300	
5.0 m		0500	
7.5 m		0750	
10.0 m		1000	
Technical Data			
Operating voltage		6...230 V AC/DC	
Protection		IP68 inserted and tightened	
Temperature range		-25...+85 °C, depending on cable quality	
Article No.			
The composition of your article number is explained on page 3.1.i		<div style="display: flex; justify-content: space-around; align-items: center;"> <span style="border-bottom: 1px solid black; padding: 0 5px;">7</span> <span style="border-bottom: 1px solid black; padding: 0 5px;">0</span> <span style="border-bottom: 1px solid black; padding: 0 5px;">7</span> <span style="border-bottom: 1px solid black; padding: 0 5px;">2</span> <span style="font-size: 2em;">-</span> <span style="border-bottom: 1px solid black; padding: 0 5px;"> </span> <span style="font-size: 2em;">-</span> <span style="border-bottom: 1px solid black; padding: 0 5px;"> </span> <span style="border-bottom: 1px solid black; padding: 0 5px;"> </span> </div>	
		<b>1</b> Form	<b>2</b> Cable Type
		<b>3</b> Cable Length	
Notes		Other versions on request. Differing cable lengths up to 2 m can be ordered in 0.2 m steps, from 2 m on in 0.5 m steps.	

# MOBILE APPLICATIONS

## Xtreme - Mobile Applications

- with open ended wires
- compatible with:
- AMP SuperSeal 1.5

## SuperSeal MSC1.5-2S

Male straight



## SuperSeal MSC1.5-3S

Male straight



<b>1 Form</b>	<b>73001</b>	<b>73081</b>
	Type	2-pole max. 24 V DC without components
Circuit diagram		
Contact layout		
<b>2 Cable Type</b>	<b>Jacket Color</b>	<b>Jacket Color</b>
Wire diameter 0.75 mm <sup>2</sup> PUR (UL), Ctracks	<b>black</b> <b>512</b>	<b>black</b> <b>513</b>
<b>3 Cable Length</b>		
1.5 m	<b>0150</b>	
3.0 m	<b>0300</b>	
5.0 m	<b>0500</b>	
7.5 m	<b>0750</b>	
10.0 m	<b>1000</b>	
<b>Technical Data</b>		
Operating voltage	max. 24 V DC	
Protection	IP67 inserted and tightened (EN 60529)	
Temperature range	-40...+125 °C, depending on cable quality	
<b>Article No.</b>		
The composition of your article number is explained on page 3.1.i	<u>7</u> <u>0</u> <u>7</u> <u>2</u> - - - - - - - - - -	- - - - - - - - - -
	<b>1 Form</b>	<b>2 Cable Type</b>
		<b>3 Cable Length</b>
<b>Notes</b>	Other versions on request. Differing cable lengths up to 2 m can be ordered in 0.2 m steps, from 2 m on in 0.5 m steps.	

Mobile Applications

# MOBILE APPLICATIONS

## Xtreme - Mobile Applications

- with open ended wires
- compatible with:
- AMP SuperSeal 1.5

### SuperSeal MSC1.5-4S

Male straight



### SuperSeal MSC1.5-6S

Male straight



<b>1 Form</b>	<b>73161</b>	<b>73221</b>	
	<p><b>Type</b></p> <p>4-pole max. 24 V DC without components</p>	<p><b>6-pole</b></p> <p>max. 24 V DC without components</p>	
<b>Circuit diagram</b>			
<b>Contact layout</b>			
<b>2 Cable Type</b>	<b>Jacket Color</b>	<b>Jacket Color</b>	
<p>Wire diameter 0.75 mm<sup>2</sup> PUR (UL), Ctracks</p>	<p><b>black</b></p> <p><b>514</b></p>	<p><b>black</b></p> <p><b>516</b></p>	
<b>3 Cable Length</b>			
1.5 m	<b>0150</b>		
3.0 m	<b>0300</b>		
5.0 m	<b>0500</b>		
7.5 m	<b>0750</b>		
10.0 m	<b>1000</b>		
<b>Technical Data</b>			
Operating voltage	max. 24 V DC		
Protection	IP67 inserted and tightened (EN 60529)		
Temperature range	-40...+125 °C, depending on cable quality		
<b>Article No.</b>			
The composition of your article number is explained on page 3.1.i	<p><b>7 0 7 2</b> - - - - - - - - - -</p>		
	<b>1 Form</b>	<b>2 Cable Type</b>	<b>3 Cable Length</b>
<b>Notes</b>	Other versions on request. Differing cable lengths up to 2 m can be ordered in 0.2 m steps, from 2 m on in 0.5 m steps.		

# MOBILE APPLICATIONS

## Xtreme - Mobile Applications

- with open ended wires
- compatible with:
- AMP SuperSeal 1.5

### SuperSeal MSC1.5-2P

Female straight



### SuperSeal MSC1.5-3P

Female straight



<b>1 Form</b>	<b>73301</b>	<b>73381</b>
	Type	2-pole max. 24 V DC without components
Circuit diagram		
Contact layout	<p>Female male contacts</p>	<p>Female male contacts</p>
<b>2 Cable Type</b>	<b>Jacket Color</b>	<b>Jacket Color</b>
Wire diameter 0.75 mm <sup>2</sup> PUR (UL), Ctracks	<b>black</b> <b>512</b>	<b>black</b> <b>513</b>
<b>3 Cable Length</b>		
1.5 m	<b>0150</b>	
3.0 m	<b>0300</b>	
5.0 m	<b>0500</b>	
7.5 m	<b>0750</b>	
10.0 m	<b>1000</b>	
<b>Technical Data</b>		
Operating voltage	max. 24 V DC	
Protection	IP67 inserted and tightened (EN 60529)	
Temperature range	-40...+125 °C, depending on cable quality	
<b>Article No.</b>		
The composition of your article number is explained on page 3.1.i	<div style="display: flex; justify-content: space-around; align-items: center;"> <span style="border-bottom: 1px solid black; padding: 0 5px;">7</span> <span style="border-bottom: 1px solid black; padding: 0 5px;">0</span> <span style="border-bottom: 1px solid black; padding: 0 5px;">7</span> <span style="border-bottom: 1px solid black; padding: 0 5px;">2</span> <span style="font-size: 2em;">-</span> <span style="border-bottom: 1px solid black; padding: 0 5px;"> </span> <span style="font-size: 2em;">-</span> <span style="border-bottom: 1px solid black; padding: 0 5px;"> </span> <span style="border-bottom: 1px solid black; padding: 0 5px;"> </span> <span style="border-bottom: 1px solid black; padding: 0 5px;"> </span> </div>	
	<b>1 Form</b>	<b>2 Cable Type</b>
		<b>3 Cable Length</b>
<b>Notes</b>	Other versions on request. Differing cable lengths up to 2 m can be ordered in 0.2 m steps, from 2 m on in 0.5 m steps.	

Mobile Applications

# MOBILE APPLICATIONS

## Xtreme - Mobile Applications

- with open ended wires
- compatible with:
- AMP SuperSeal 1.5

### SuperSeal MSC1.5-4P

Female straight



### SuperSeal MSC1.5-6P

Female straight



<b>1 Form</b>	<b>73461</b>	<b>73521</b>
	Type	4-pole max. 24 V DC without components
Circuit diagram		
Contact layout		
<b>2 Cable Type</b>	<b>Jacket Color</b>	<b>Jacket Color</b>
Wire diameter 0.75 mm <sup>2</sup> PUR (UL), Ctracks	<b>black</b> <b>514</b>	<b>black</b> <b>516</b>
<b>3 Cable Length</b>		
1.5 m	<b>0150</b>	
3.0 m	<b>0300</b>	
5.0 m	<b>0500</b>	
7.5 m	<b>0750</b>	
10.0 m	<b>1000</b>	
<b>Technical Data</b>		
Operating voltage	max. 24 V DC	
Protection	IP67 inserted and tightened (EN 60529)	
Temperature range	-40...+125 °C, depending on cable quality	
<b>Article No.</b>		
The composition of your article number is explained on page 3.1.i	<div style="display: flex; justify-content: space-around; align-items: center;"> <span style="border-bottom: 1px solid black; padding: 0 5px;">7</span> <span style="border-bottom: 1px solid black; padding: 0 5px;">0</span> <span style="border-bottom: 1px solid black; padding: 0 5px;">7</span> <span style="border-bottom: 1px solid black; padding: 0 5px;">2</span> <span style="font-size: 2em;">-</span> <span style="border-bottom: 1px solid black; padding: 0 5px;"> </span> <span style="font-size: 2em;">-</span> <span style="border-bottom: 1px solid black; padding: 0 5px;"> </span> <span style="border-bottom: 1px solid black; padding: 0 5px;"> </span> </div>	
	<b>1 Form</b>	<b>2 Cable Type</b>
		<b>3 Cable Length</b>
<b>Notes</b>	Other versions on request. Differing cable lengths up to 2 m can be ordered in 0.2 m steps, from 2 m on in 0.5 m steps.	



# M23 ROUND PLUG CONNECTORS MADE FOR DISTRIBUTION BOXES

- Highly resistant, halogen-free molding
- Safely sealed – acc. to IP67
- Reliable – 100% tested

## COMPACT CONNECTOR FOR SAFE SIGNAL TRANSFER

Murrelektronik's M23 connectors are specially designed for distribution systems with M23 connections. They ensure a safe signal transfer from the distribution box to the control cabinet and a safe power supply to the distributor as well as the sensors and actuators connected to it.

### With Open Ended Wires



#### M23 female, 12-pole

- Straight/90°
- For unshielded distribution boxes

Page 3.9.1



#### M23 female, 19-pole

- Straight/90°
- For unshielded distribution boxes

Page 3.9.2



#### M23 female, 19-pole

- Straight
- For shielded distribution boxes

Page 3.9.4

# M23 ROUND PLUG CONNECTORS

With open ended wires

– 12-pole

Female

straight



Female

90°



<b>1 Form</b>	<b>23051</b>	<b>23151</b>
Type	11-pole used for 8-way distribution box, 4-pole	11-pole used for 8-way distribution box, 4-pole
Circuit diagram		
Contact layout	<p>Female</p>	
<b>2 Cable Type</b>	<b>Jacket Color – No./diameter of wires</b>	
PUR/PVC (UL/CSA), Ctracks	gray 362 – 8 × 0.34 + 3 × 0.75 mm <sup>2</sup>	gray 362 – 8 × 0.34 + 3 × 0.75 mm <sup>2</sup>
<b>3 Cable Length</b>		
5.0 m	0500	
10.0 m	1000	
15.0 m	1500	
<b>Technical Data</b>		
Operating voltage	max. 125 V AC/DC	
Protection	IP65 and IP67 when plugged and screwed down (EN 60529)	
Temperature range	-25...+85 °C, depending on cable quality	
<b>Article No.</b>		
The composition of your article number is explained on page 3.1.i	<div style="display: flex; justify-content: space-around; align-items: center;"> <span style="border-bottom: 1px solid black; padding: 0 5px;">7</span> <span style="border-bottom: 1px solid black; padding: 0 5px;">0</span> <span style="border-bottom: 1px solid black; padding: 0 5px;">0</span> <span style="border-bottom: 1px solid black; padding: 0 5px;">0</span> <span style="font-size: 2em;">-</span> <span style="border-bottom: 1px solid black; padding: 0 5px;"> </span> <span style="font-size: 2em;">-</span> <span style="border-bottom: 1px solid black; padding: 0 5px;"> </span> <span style="border-bottom: 1px solid black; padding: 0 5px;"> </span> <span style="border-bottom: 1px solid black; padding: 0 5px;"> </span> </div>	
	<b>1 Form</b>	<b>2 Cable Type</b>
		<b>3 Cable Length</b>
Notes	Other versions on request.	

# M23 ROUND PLUG CONNECTORS

With open ended wires

- 19-pole

Female

straight



<b>1 Form</b>	<b>23251</b>	<b>23251</b>
	<b>Approvals</b>	
<b>Type</b>	<b>19-pole used</b>	<b>19-pole used</b>
	<b>for 8-way distribution boxes, 5-pole</b>	<b>for 8-way distribution boxes, 5-pole</b>
<b>Circuit diagram</b>		
	<b>Contact layout</b>	<p>Female</p>
<b>2 Cable Type</b>	<b>Jacket Color</b> – No./diameter of wires	
	<b>gray</b>	<b>gray</b>
	PUR/PVC (UL/CSA), Ctracks PUR (UL/CSA), robots/Ctracks	<b>398</b> – 16 × 0.34 + 3 × 0.75 mm <sup>2</sup>
<b>3 Cable Length</b>		
	5.0 m	<b>0500</b>
	10.0 m	<b>1000</b>
15.0 m	<b>1500</b>	
<b>Technical Data</b>		
Operating voltage	max. 125 V AC/DC	
Protection	IP67 inserted and tightened (EN 60529)	
Temperature range	-5...+70 °C, depending on cable quality	-5...+70 °C, depending on cable quality
<b>Article No.</b>		
The composition of your article number is explained on page 3.1.i	<b>7 0 0 0</b> – — — — —	— — — — —
	<b>1 Form</b>	<b>2 Cable Type</b>
		<b>3 Cable Length</b>
<b>Notes</b>		
Other versions on request.		

M23 Round Plug Connectors

# M23 ROUND PLUG CONNECTORS

With open ended wires

– 19-pole

Female  
90°



<b>1 Form</b>	<b>23351</b>	<b>23351</b>
Approvals		cULus
Type	19-pole used for 8-way distribution boxes, 5-pole	19-pole used for 8-way distribution boxes, 5-pole
Circuit diagram	<ul style="list-style-type: none"> <li>15 &gt; white</li> <li>7 &gt; gray/pink</li> <li>5 &gt; green</li> <li>4 &gt; red/blue</li> <li>16 &gt; yellow</li> <li>8 &gt; white/green</li> <li>3 &gt; gray</li> <li>14 &gt; brown/green</li> <li>17 &gt; pink</li> <li>9 &gt; white/yellow</li> <li>2 &gt; red</li> <li>13 &gt; yellow/brown</li> <li>11 &gt; black</li> <li>10 &gt; white/gray</li> <li>1 &gt; violet</li> <li>18 &gt; gray/brown</li> <li>19 &gt; brown 0.75mm<sup>2</sup></li> <li>6 &gt; blue 0.75mm<sup>2</sup></li> <li>12 &gt; green/yellow 0.75mm<sup>2</sup></li> </ul>	<ul style="list-style-type: none"> <li>15 &gt; white</li> <li>7 &gt; gray/pink</li> <li>5 &gt; green</li> <li>4 &gt; red/blue</li> <li>16 &gt; yellow</li> <li>8 &gt; white/green</li> <li>3 &gt; gray</li> <li>14 &gt; brown/green</li> <li>17 &gt; pink</li> <li>9 &gt; white/yellow</li> <li>2 &gt; red</li> <li>13 &gt; yellow/brown</li> <li>11 &gt; black</li> <li>10 &gt; white/gray</li> <li>1 &gt; violet</li> <li>18 &gt; gray/brown</li> <li>19 &gt; brown 1.0mm<sup>2</sup></li> <li>6 &gt; blue 1.0mm<sup>2</sup></li> <li>12 &gt; green/yellow 1.0mm<sup>2</sup></li> </ul>
Contact layout	Female 	
<b>2 Cable Type</b>	<b>Jacket Color</b> – No./diameter of wires	
	gray	gray
PUR/PVC (UL/CSA), Ctracks	398 – 16 × 0.34 + 3 × 0.75 mm <sup>2</sup>	
PUR (UL/CSA), robots/Ctracks		452 – 16 × 0.5 + 3 × 1.0 mm <sup>2</sup>
<b>3 Cable Length</b>		
5.0 m	0500	
10.0 m	1000	
15.0 m	1500	
<b>Technical Data</b>		
Operating voltage	max. 125 V AC/DC	
Protection	IP67 inserted and tightened (EN 60529)	
Temperature range	-5...+70 °C, depending on cable quality	-5...+70 °C, depending on cable quality
<b>Article No.</b>		
The composition of your article number is explained on page 3.1.i	<b>7 0 0 0</b> – _____ – _____ – _____	
	<b>1 Form</b>	<b>2 Cable Type</b>
		<b>3 Cable Length</b>
<b>Notes</b>	Other versions on request.	

# M23 ROUND PLUG CONNECTORS

With open ended wires

- 19-pole

Female  
straight



1 Form	23711	23751
Type	11-pole used shielded for 4-way distribution boxes, 5-pole	19-pole used shielded for 8-way distribution boxes, 5-pole
Circuit diagram		
Contact layout	<p>Female</p>	
2 Cable Type	Jacket Color – No./diameter of wires	
	gray	gray
PUR (UL/CSA), robots/C-tracks	373 – 8 × 0.34 + 3 × 0.75 mm <sup>2</sup>	401 – 16 × 0.34 + 3 × 0.75 mm <sup>2</sup>
3 Cable Length		
5.0 m	0500	
10.0 m	1000	
15.0 m	1500	
Technical Data		
Operating voltage	max. 125 V AC/DC	
Protection	IP65 and IP67 when plugged and screwed down (EN 60529)	
Temperature range	-25...+85 °C, depending on cable quality	
Article No.		
The composition of your article number is explained on page 3.1.i	<div style="display: flex; justify-content: space-around; align-items: center;"> <span style="border-bottom: 1px solid black; padding: 0 5px;">7</span> <span style="border-bottom: 1px solid black; padding: 0 5px;">0</span> <span style="border-bottom: 1px solid black; padding: 0 5px;">0</span> <span style="border-bottom: 1px solid black; padding: 0 5px;">0</span> <span style="font-size: 1.2em;">-</span> <span style="border-bottom: 1px solid black; padding: 0 5px;"> </span> <span style="font-size: 1.2em;">-</span> <span style="border-bottom: 1px solid black; padding: 0 5px;"> </span> <span style="border-bottom: 1px solid black; padding: 0 5px;"> </span> <span style="border-bottom: 1px solid black; padding: 0 5px;"> </span> </div>	
	<b>1</b> Form	<b>2</b> Cable Type
		<b>3</b> Cable Length
Notes	Other versions on request.	

M23 Round Plug Connectors



# ROUND PLUG CONNECTORS POWER POWERFUL AND SAFE

- Proven and reliable
- Molded and encapsulated plug connector
- Easy and safe connection



## PLUG CONNECTOR FOR HIGH POWER TRANSFER

Perfect electrical connection, tightness and media resistance are the basic requirements for all types of plug connectors. In the field of motor connection technology, additional special properties are required: large connection cross-sections, high power with the smallest possible design and – most importantly – integrated anti-vibration locks that keeps the connector securely in place even if severe vibrations occur.

- The **M12 Power** is an extremely compact and performant M12 plug connector.
- The **MQ15 X-Power** enables particularly fast installation.
- The **7/8" round plug connector** has been optimized for highest performance

**As a matter of course, all our plug connectors are tested 100%.**

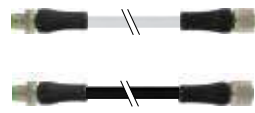
### M12 Power

	<p><b>With open ended wires</b></p>	<p><b>M12 male/female</b></p> <ul style="list-style-type: none"> <li>• Straight</li> <li>• K-coded, L-coded, S-coded, T-coded</li> </ul>	<p><i>Page 3.10.1</i></p>
	<p><b>Connection cables</b></p>	<p><b>M12 male – M12 female</b></p> <ul style="list-style-type: none"> <li>• Straight</li> <li>• K-coded, L-coded, S-coded, T-coded</li> </ul>	<p><i>Page 3.10.5</i></p>
	<p><b>Field-wireable Screw terminals</b></p> <p><b>Field-wireable Terminals with Insulation Displacement Technology (IDC)</b></p>	<p><b>M12 male/female</b></p> <ul style="list-style-type: none"> <li>• Straight</li> <li>• S-coded, T-coded</li> </ul> <p><b>M12 male/female</b></p> <ul style="list-style-type: none"> <li>• Straight</li> <li>• L-coded</li> </ul>	<p><i>Page 3.10.7</i></p>

## MQ15 X-Power

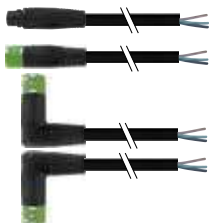

With open ended wires

**MQ15 X-Power male/female**

- Unshielded/shielded
- Straight
- 90°

Page 3.10.10



Connection cables

**MQ15 X-Power male – MQ15 X-Power female**

- Unshielded/shielded
- Straight

Page 3.10.25

## 7/8"

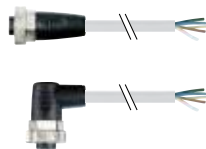

With open ended wires

**7/8" male/female**

- Straight/90°

Page 3.10.29



Connection cables

**7/8" male – 7/8" female**

- Straight/90°

Page 3.10.30



Field-wireable  
Screw terminals

**7/8" male/female**

- Straight/90°

Page 3.10.31

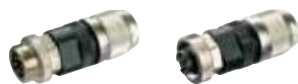

Field-wireable  
Terminals with Insulation  
Displacement Technology (IDC)

**7/8" male/female**

- Straight

Page 3.10.33

## M23 Drives (Motors)



*We offer a wide range  
for M23 Drives. Just talk to us!*

# ROUND PLUG CONNECTORS POWER

With open ended wires

– M12 Power

**Male**  
straight



1 Form	P3201	P4201
Type	5-pole K-coded Operating current: max. 12 A	5-pole L-coded Operating current: max. 16 A
Circuit diagram		
Contact layout		
2 Cable Type	Jacket Color	Jacket Color
Wire diameter 1.5 mm <sup>2</sup> PUR/PVC PUR (UL/CSA), robots/Ctracks	black P05	gray 966 black P04
3 Cable Length		
1.5 m	0150	
3.0 m	0300	
5.0 m	0500	
7.5 m	0750	
10.0 m	1000	
Technical Data		
Operating voltage	max. 630 V AC/DC	max. 63 V AC/DC
Protection	IP65 and IP67 when plugged and screwed down (EN 60529)	
Temperature range	-25...+85 °C, depending on cable quality	
Article No.		
The composition of your article number is explained on page 3.1.i	<div style="display: flex; justify-content: space-around; align-items: center;"> <span style="border-bottom: 1px solid black; padding: 0 5px;">7</span> <span style="border-bottom: 1px solid black; padding: 0 5px;">0</span> <span style="border-bottom: 1px solid black; padding: 0 5px;">0</span> <span style="border-bottom: 1px solid black; padding: 0 5px;">0</span> <span style="font-size: 2em;">-</span> <span style="border-bottom: 1px dashed black; padding: 0 10px;"> </span> <span style="font-size: 2em;">-</span> <span style="border-bottom: 1px dashed black; padding: 0 10px;"> </span> <span style="border-bottom: 1px dashed black; padding: 0 10px;"> </span> <span style="border-bottom: 1px dashed black; padding: 0 10px;"> </span> </div>	
	<b>1</b> Form	<b>2</b> Cable Type
		<b>3</b> Cable Length
Notes		
	Other versions on request. Differing cable lengths up to 2 m can be ordered in 0.2 m steps, from 2 m on in 0.5 m steps.	



# ROUND PLUG CONNECTORS POWER

With open ended wires

– M12 Power

Female  
straight



1 Form	P 3 2 2 1	P 4 2 2 1						
Type	5-pole K-coded Operating current: max. 12 A	5-pole L-coded Operating current: max. 16 A						
Circuit diagram								
Contact layout	<p>Female</p>	<p>Female</p>						
2 Cable Type	Jacket Color	Jacket Color						
Wire diameter 1.5 mm <sup>2</sup> PUR/PVC PUR (UL/CSA), robots/Ctracks	<table border="1"> <tr><td>black</td></tr> <tr><td>P05</td></tr> </table>	black	P05	<table border="1"> <tr><td>gray</td><td>black</td></tr> <tr><td>966</td><td>P04</td></tr> </table>	gray	black	966	P04
black								
P05								
gray	black							
966	P04							
3 Cable Length								
1.5 m	0150							
3.0 m	0300							
5.0 m	0500							
7.5 m	0750							
10.0 m	1000							
Technical Data								
Operating voltage	max. 630 V AC/DC	max. 63 V AC/DC						
Protection	IP65 and IP67 when plugged and screwed down (EN 60529)							
Temperature range	-25...+85 °C, depending on cable quality							
Article No.								
The composition of your article number is explained on page 3.1.i	<table border="1"> <tr> <td style="text-align: center;">7 0 0 0</td> <td style="text-align: center;">-</td> <td style="text-align: center;">-</td> <td style="text-align: center;">-</td> <td style="text-align: center;">-</td> </tr> </table>		7 0 0 0	-	-	-	-	
7 0 0 0	-	-	-	-				
	<b>1</b> Form	<b>2</b> Cable Type	<b>3</b> Cable Length					
Notes	Other versions on request. Differing cable lengths up to 2 m can be ordered in 0.2 m steps, from 2 m on in 0.5 m steps.							

# ROUND PLUG CONNECTORS POWER

With open ended wires

– M12 Power

**Male**  
straight



1 Form	P 6201	P 7201
Type	4-pole S-coded Operating current: max. 12 A	4-pole T-coded Operating current: max. 12 A
Circuit diagram		
Contact layout		
2 Cable Type	Jacket Color	Jacket Color
Wire diameter 1.5 mm <sup>2</sup> PUR (UL/CSA), robots/Ctracks	black P06	black P07
3 Cable Length		
1.5 m	0150	
3.0 m	0300	
5.0 m	0500	
7.5 m	0750	
10.0 m	1000	
Technical Data		
Operating voltage	max. 630 V AC/DC	max. 63 V AC/DC
Protection	IP65 and IP67 when plugged and screwed down (EN 60529)	
Temperature range	-25...+85 °C, depending on cable quality	
Article No.		
The composition of your article number is explained on page 3.1.i	<div style="display: flex; justify-content: space-around; align-items: center;"> <span style="border: 1px solid black; padding: 2px 5px;">7</span> <span style="border: 1px solid black; padding: 2px 5px;">0</span> <span style="border: 1px solid black; padding: 2px 5px;">0</span> <span style="border: 1px solid black; padding: 2px 5px;">0</span> <span style="font-size: 2em;">-</span> <span style="border: 1px solid black; padding: 2px 5px;">-</span> <span style="font-size: 2em;">-</span> <span style="border: 1px solid black; padding: 2px 5px;">-</span> <span style="font-size: 2em;">-</span> </div>	
	<b>1 Form</b>	<b>2 Cable Type</b>
		<b>3 Cable Length</b>
Notes	Other versions on request. Differing cable lengths up to 2 m can be ordered in 0.2 m steps, from 2 m on in 0.5 m steps.	

Round Plug Connectors Power

# ROUND PLUG CONNECTORS POWER

With open ended wires

– M12 Power

Female  
straight



1 Form	P 6221	P 7221
Type	4-pole S-coded Operating current: max. 12 A	4-pole T-coded Operating current: max. 12 A
Circuit diagram		
Contact layout		
2 Cable Type	Jacket Color	Jacket Color
Wire diameter 1.5 mm <sup>2</sup> PUR (UL/CSA), robots/Ctracks	black P06	black P07
3 Cable Length		
1.5 m	0150	
3.0 m	0300	
5.0 m	0500	
7.5 m	0750	
10.0 m	1000	
Technical Data		
Operating voltage	max. 630 V AC/DC	max. 63 V AC/DC
Protection	IP65 and IP67 when plugged and screwed down (EN 60529)	
Temperature range	-25...+85 °C, depending on cable quality	
Article No.		
The composition of your article number is explained on page 3.1.i	<div style="display: flex; justify-content: space-around; align-items: center;"> <span style="border-bottom: 1px solid black; padding: 0 5px;">7</span> <span style="border-bottom: 1px solid black; padding: 0 5px;">0</span> <span style="border-bottom: 1px solid black; padding: 0 5px;">0</span> <span style="border-bottom: 1px solid black; padding: 0 5px;">0</span> <span style="font-size: 2em;">-</span> <span style="border-bottom: 1px solid black; padding: 0 5px;">_</span> <span style="font-size: 2em;">-</span> <span style="border-bottom: 1px solid black; padding: 0 5px;">_</span> <span style="border-bottom: 1px solid black; padding: 0 5px;">_</span> <span style="border-bottom: 1px solid black; padding: 0 5px;">_</span> </div>	
	<b>1</b> Form	<b>2</b> Cable Type
		<b>3</b> Cable Length
Notes	Other versions on request. Differing cable lengths up to 2 m can be ordered in 0.2 m steps, from 2 m on in 0.5 m steps.	

Round Plug Connectors Power

# ROUND PLUG CONNECTORS POWER

Connection cables

– M12 Power

**Male**  
straight

**Female**  
straight



1 Form	P3241	P4241
Type	5-pole K-coded Operating current: max. 12 A	5-pole L-coded Operating current: max. 16 A
Circuit diagram		
Contact layout		
2 Cable Type	Jacket Color	Jacket Color
Wire diameter 1.5 mm <sup>2</sup> PUR/PVC PUR (UL/CSA), robots/Ctracks	black P05	gray 966 black P04
3 Cable Length		
1.5 m	0150	
3.0 m	0300	
5.0 m	0500	
7.5 m	0750	
10.0 m	1000	
Technical Data		
Operating voltage	max. 630 V AC/DC	max. 63 V AC/DC
Protection	IP65 and IP67 when plugged and screwed down (EN 60529)	
Temperature range	-25...+85 °C, depending on cable quality	
Article No.		
The composition of your article number is explained on page 3.1.i	<span style="font-size: 24pt; font-weight: bold;">7 0 0 0</span> - - - - - - - - - -	
	<b>1</b> Form	<b>2</b> Cable Type
		<b>3</b> Cable Length
Notes	Other versions on request. Differing cable lengths up to 2 m can be ordered in 0.2 m steps, from 2 m on in 0.5 m steps.	

Round Plug Connectors Power

# ROUND PLUG CONNECTORS POWER

## Connection cables

– M12 Power

### Male

straight

### Female

straight



1 Form	P 6241	P 7241
Type	4-pole S-coded Operating current: max. 12 A	4-pole T-coded Operating current: max. 12 A
Circuit diagram		
Contact layout		
2 Cable Type	Jacket Color	Jacket Color
Wire diameter 1.5 mm <sup>2</sup> PUR (UL/CSA), robots/Ctracks	black P06	black P07
3 Cable Length		
1.5 m	0150	
3.0 m	0300	
5.0 m	0500	
7.5 m	0750	
10.0 m	1000	
Technical Data		
Operating voltage	max. 630 V AC/DC	max. 63 V AC/DC
Protection	IP65 and IP67 when plugged and screwed down (EN 60529)	
Temperature range	-25...+85 °C, depending on cable quality	
Article No.		
The composition of your article number is explained on page 3.1.i	<div style="display: flex; justify-content: space-around; align-items: center;"> <span style="border-bottom: 1px solid black; padding: 0 5px;">7</span> <span style="border-bottom: 1px solid black; padding: 0 5px;">0</span> <span style="border-bottom: 1px solid black; padding: 0 5px;">0</span> <span style="border-bottom: 1px solid black; padding: 0 5px;">0</span> <span style="font-size: 2em;">-</span> <span style="border-bottom: 1px solid black; padding: 0 5px;">_</span> <span style="font-size: 2em;">-</span> <span style="border-bottom: 1px solid black; padding: 0 5px;">_</span> <span style="border-bottom: 1px solid black; padding: 0 5px;">_</span> </div>	
	<b>1</b> Form	<b>2</b> Cable Type
		<b>3</b> Cable Length
Notes	Other versions on request. Differing cable lengths up to 2 m can be ordered in 0.2 m steps, from 2 m on in 0.5 m steps.	

Round Plug Connectors Power

# ROUND PLUG CONNECTORS POWER

Field-wireable

– M12 Power

– Screw terminals

Approvals: 

**Male**  
straight



**Female**  
straight

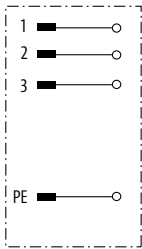
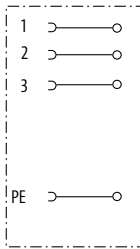
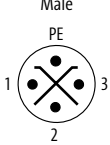
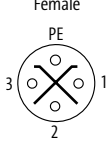

1 Form	P 6391	P 6411
Type	4-pole S-coded	4-pole S-coded
Circuit diagram		
Sealing range (cable Ø)	8...10 mm	
Contact layout	<p>Male</p> 	<p>Female</p> 
<b>Technical Data</b>		
Operating voltage	max. 630 V AC/DC	
Rated surge voltage	6 kV	
Operating current per contact	max. 12 A	
Material group	IEC 60664-1, category III	
Connection cross section	max. 1.5 mm <sup>2</sup>	
Coding	S-coded	
Sealing range (cable Ø)	8...10 mm	
Locking of ports	Screw thread M12 × 1 mm (recommended torque 0.6 Nm) self-securing	
Protection	IP67 inserted and tightened (EN 60529)	
Material	PA	
suitable for corrugated tube (internal Ø)	without	
Temperature range	-40...+85 °C	
<b>Article No.</b>		
The composition of your article number is explained on page 3.1.i	<p style="text-align: center;"><u>7 0 0 0</u> - <u>    </u> - <u>0 0 0</u>   <u>0 0 0 0</u></p>	
<b>1 Form</b>		
<b>Notes</b>		
Other versions on request.		

# ROUND PLUG CONNECTORS POWER

Field-wireable

– M12 Power

– Screw terminals

Approvals: 

**Male**

straight



**Female**

straight



## 1 Form

### P7391

### P7411

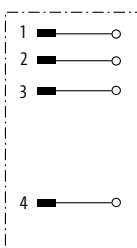
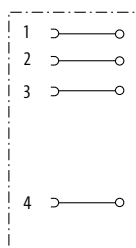
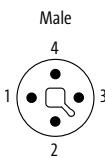
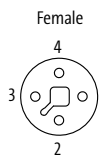
Type	4-pole T-coded	4-pole T-coded
Circuit diagram		
Sealing range (cable Ø)	8...10 mm	
Contact layout	<p>Male</p> 	<p>Female</p> 

## Technical Data

Operating voltage	max. 63 V AC/DC
Rated surge voltage	1.5 kV
Operating current per contact	max. 12 A
Material group	IEC 60664-1, category III
Connection cross section	max. 1.5 mm <sup>2</sup>
Coding	T-coded
Sealing range (cable Ø)	8...10 mm
Locking of ports	Screw thread M12 × 1 mm (recommended torque 0.6 Nm) self-securing
Protection	IP67 inserted and tightened (EN 60529)
Material	PA
suitable for corrugated tube (internal Ø)	without
Compression gland	M12 (SW18)
Temperature range	-40...+85 °C

## Article No.

The composition of your article number is explained on page 3.1.i

7 0 0 0

- - - - -

0 0 0

0 0 0 0

**1** Form

Notes

Other versions on request.

# ROUND PLUG CONNECTORS POWER

Field-wireable

– M12 Power

– IDC terminals

**Male**

straight



**Female**

straight



1 Form	P4391	P4421
Type	5-pole L-coded	5-pole L-coded
Circuit diagram		
Contact layout	<p>Male</p>	<p>Female</p>
<b>Technical Data</b>		
Operating voltage	max. 63 V DC	
Operating current per contact	max. 12 A	
Connection cross section	max. 1.5 mm <sup>2</sup>	
Coding	L-coded	
Sealing range (cable Ø)	5.8...13.5 mm	
Locking of ports	Screw thread M12 × 1 mm (recommended torque 0.6 Nm) self-securing	
Compression gland	M12 (SW17)	
Protection	IP65 and IP67 when plugged and screwed down (EN 60529)	
Material	Zinc die casting	
suitable for corrugated tube (internal Ø)	without	
Mating cycles	≥ 500	
Temperature range	-40...+85 °C	
<b>Article No.</b>		
The composition of your article number is explained on page 3.1.i	<p style="text-align: center;"><u>7 0 0 0</u> - <u>      </u> - <u>0 0 0</u> <u>0 0 0 0</u></p>	
<b>1 Form</b>		
Notes		
Other versions on request.		



# ROUND PLUG CONNECTORS POWER

With open ended wires

– MQ15 X-Power

Male

straight



1 Form	P 8101	P 8101
Type	6-pole max. 13 A (Power); max. 10 A (Signal)	6-pole max. 16 A (Power); max. 10 A (Signal)

Circuit diagram

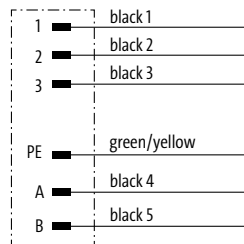

Contact layout

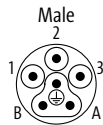

2 Cable Type	Jacket Color	Jacket Color
Wire diameter 1.5 mm <sup>2</sup>	black	black
PVC (UL)	P24	
PUR (UL), C-tracks	P84	
Wire diameter 2.5 mm <sup>2</sup>		
PUR (UL), C-tracks		P01
PVC (UL)		P21

3 Cable Length	
1.0 m	0100
2.0 m	0200
3.0 m	0300
5.0 m	0500
10.0 m	1000

Technical Data

Operating voltage	max. 600 V AC (Power); max. 63 V AC/DC (Signal)
Protection	IP67 inserted and tightened (EN 60529)
Temperature range	-25...+80 °C, depending on cable quality

Article No.

The composition of your article number is explained on page 3.1.i

7 0 0 0 - - - - - - - - - -

**1** Form      **2** Cable Type      **3** Cable Length

Notes

Other versions on request. Differing cable lengths up to 2 m can be ordered in 0.2 m steps, from 2 m on in 0.5 m steps.

# ROUND PLUG CONNECTORS POWER

With open ended wires

– MQ15 X-Power

Female

straight



<b>1 Form</b>	<b>P 8121</b>	<b>P 8121</b>
	Type 6-pole max. 13 A (Power); max. 10 A (Signal)	Type 6-pole max. 16 A (Power); max. 10 A (Signal)
Circuit diagram		
Contact layout		
<b>2 Cable Type</b>	<b>Jacket Color</b>	<b>Jacket Color</b>
Wire diameter 1.5 mm <sup>2</sup> PVC (UL) PUR (UL), C-tracks	black P24 P84	black
Wire diameter 2.5 mm <sup>2</sup> PUR (UL), C-tracks PVC (UL)		P01 P21
<b>3 Cable Length</b>		
1.0 m	0100	
2.0 m	0200	
3.0 m	0300	
5.0 m	0500	
10.0 m	1000	
<b>Technical Data</b>		
Operating voltage	max. 600 V AC (Power); max. 63 V AC/DC (Signal)	
Protection	IP67 inserted and tightened (EN 60529)	
Temperature range	-25...+80 °C, depending on cable quality	
<b>Article No.</b>		
The composition of your article number is explained on page 3.1.i	<div style="display: flex; justify-content: space-around; align-items: center;"> <span style="border: 1px solid black; padding: 2px 5px;">7</span> <span style="border: 1px solid black; padding: 2px 5px;">0</span> <span style="border: 1px solid black; padding: 2px 5px;">0</span> <span style="border: 1px solid black; padding: 2px 5px;">0</span> <span style="font-size: 2em;">-</span> <span style="border: 1px solid black; padding: 2px 5px;">-</span> <span style="font-size: 2em;">-</span> <span style="border: 1px solid black; padding: 2px 5px;">-</span> <span style="font-size: 2em;">-</span> <span style="border: 1px solid black; padding: 2px 5px;">-</span> </div>	
	<b>1 Form</b>	<b>2 Cable Type</b>
		<b>3 Cable Length</b>
<b>Notes</b>	Other versions on request. Differing cable lengths up to 2 m can be ordered in 0.2 m steps, from 2 m on in 0.5 m steps.	

Round Plug Connectors Power

# ROUND PLUG CONNECTORS POWER

With open ended wires

– MQ15 X-Power

Male

straight



<b>1 Form</b>	<b>P 8201</b>	<b>P 8201</b>
	4-pole Operating current: max. 13 A	4-pole Operating current: max. 16 A

Circuit diagram

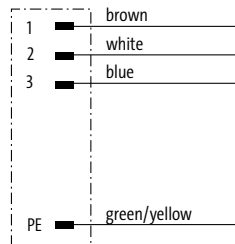

Contact layout

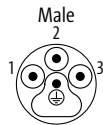

<b>2 Cable Type</b>	<b>Jacket Color</b>	<b>Jacket Color</b>																
	<table border="1"> <tr> <td>Wire diameter 1.5 mm<sup>2</sup></td> <td>black</td> </tr> <tr> <td>PVC (UL)</td> <td>P22</td> </tr> <tr> <td>PUR (UL), C-tracks</td> <td>P02</td> </tr> <tr> <td>Wire diameter 2.5 mm<sup>2</sup></td> <td></td> </tr> <tr> <td>PUR (UL), C-tracks</td> <td></td> </tr> <tr> <td>PVC (UL)</td> <td></td> </tr> </table>	Wire diameter 1.5 mm <sup>2</sup>	black	PVC (UL)	P22	PUR (UL), C-tracks	P02	Wire diameter 2.5 mm <sup>2</sup>		PUR (UL), C-tracks		PVC (UL)		<table border="1"> <tr> <td>black</td> </tr> <tr> <td></td> </tr> <tr> <td></td> </tr> <tr> <td>P03</td> </tr> <tr> <td>P23</td> </tr> </table>	black			P03
Wire diameter 1.5 mm <sup>2</sup>	black																	
PVC (UL)	P22																	
PUR (UL), C-tracks	P02																	
Wire diameter 2.5 mm <sup>2</sup>																		
PUR (UL), C-tracks																		
PVC (UL)																		
black																		
P03																		
P23																		

<b>3 Cable Length</b>	1.0 m	0100
	2.0 m	0200
	3.0 m	0300
	5.0 m	0500
	10.0 m	1000

**Technical Data**

Operating voltage	max. 600 V AC
Protection	IP67 inserted and tightened (EN 60529)
Temperature range	-25...+80 °C, depending on cable quality

**Article No.**

The composition of your article number is explained on page 3.1.i

**7 0 0 0** - - - - -

**1** Form      **2** Cable Type      **3** Cable Length

Notes

Other versions on request. Differing cable lengths up to 2 m can be ordered in 0.2 m steps, from 2 m on in 0.5 m steps.

# ROUND PLUG CONNECTORS POWER

With open ended wires

– MQ15 X-Power

Female

straight



<b>1 Form</b>		<b>P 8 2 2 1</b>	<b>P 8 2 2 1</b>
Type	4-pole	Operating current: max. 13 A	4-pole Operating current: max. 16 A
Circuit diagram			
Contact layout			
<b>2 Cable Type</b>		<b>Jacket Color</b>	<b>Jacket Color</b>
Wire diameter 1.5 mm <sup>2</sup>		black	black
PVC (UL)		P22	
PUR (UL), C-tracks		P02	
Wire diameter 2.5 mm <sup>2</sup>			
PUR (UL), C-tracks			P03
PVC (UL)			P23
<b>3 Cable Length</b>			
1.0 m	0100		
2.0 m	0200		
3.0 m	0300		
5.0 m	0500		
10.0 m	1000		
<b>Technical Data</b>			
Operating voltage	max. 600 V AC		
Protection	IP67 inserted and tightened (EN 60529)		
Temperature range	-25...+80 °C, depending on cable quality		
<b>Article No.</b>			
The composition of your article number is explained on page 3.1.i	<div style="display: flex; justify-content: space-around; align-items: center;"> <span style="border-bottom: 1px solid black; padding: 0 5px;">7</span> <span style="border-bottom: 1px solid black; padding: 0 5px;">0</span> <span style="border-bottom: 1px solid black; padding: 0 5px;">0</span> <span style="border-bottom: 1px solid black; padding: 0 5px;">0</span> <span style="font-size: 2em;">-</span> <span style="border-bottom: 1px solid black; padding: 0 5px;"> </span> <span style="font-size: 2em;">-</span> <span style="border-bottom: 1px solid black; padding: 0 5px;"> </span> <span style="border-bottom: 1px solid black; padding: 0 5px;"> </span> <span style="border-bottom: 1px solid black; padding: 0 5px;"> </span> </div>		
	<b>1</b>	<b>2</b>	<b>3</b>
	Form	Cable Type	Cable Length
<b>Notes</b>	Other versions on request. Differing cable lengths up to 2 m can be ordered in 0.2 m steps, from 2 m on in 0.5 m steps.		

# ROUND PLUG CONNECTORS POWER

With open ended wires

– MQ15 X-Power

Female

90°



<b>1 Form</b>	<b>P 8131</b>	<b>P 8131</b>
	6-pole max. 13 A (Power); max. 10 A (Signal)	6-pole max. 16 A (Power); max. 10 A (Signal)
<b>Circuit diagram</b>		
<b>Contact layout</b>		
<b>2 Cable Type</b>	<b>Jacket Color</b>	<b>Jacket Color</b>
	<b>Wire diameter 1.5 mm<sup>2</sup></b> PVC (UL) PUR (UL), C-tracks <b>Wire diameter 2.5 mm<sup>2</sup></b> PUR (UL), C-tracks PVC (UL)	black P24 P84
<b>3 Cable Length</b>	1.0 m	0100
	2.0 m	0200
	3.0 m	0300
	5.0 m	0500
	10.0 m	1000
<b>Technical Data</b>	Operating voltage: max. 600 V AC (Power); max. 63 V AC/DC (Signal) Protection: IP67 inserted and tightened (EN 60529) Temperature range: -25...+80 °C, depending on cable quality	
<b>Article No.</b>	The composition of your article number is explained on page 3.1.i 7 0 0 0 - - - - -	
	<b>1 Form</b>	<b>2 Cable Type</b>
		<b>3 Cable Length</b>
<b>Notes</b>	Other versions on request. Differing cable lengths up to 2 m can be ordered in 0.2 m steps, from 2 m on in 0.5 m steps.	

Round Plug Connectors Power

# ROUND PLUG CONNECTORS POWER

With open ended wires

– MQ15 X-Power

Female

90°



<b>1 Form</b>	<b>P 8132</b>	<b>P 8132</b>
Type	6-pole max. 13 A (Power); max. 10 A (Signal)	6-pole max. 16 A (Power); max. 10 A (Signal)
Circuit diagram		
Contact layout		
<b>2 Cable Type</b>	<b>Jacket Color</b>	<b>Jacket Color</b>
Wire diameter 1.5 mm <sup>2</sup>	black	black
PVC (UL)	P24	
PUR (UL), C-tracks	P84	
Wire diameter 2.5 mm <sup>2</sup>		
PUR (UL), C-tracks		P01
PVC (UL)		P21
<b>3 Cable Length</b>		
1.0 m	0100	
2.0 m	0200	
3.0 m	0300	
5.0 m	0500	
10.0 m	1000	
<b>Technical Data</b>		
Operating voltage	max. 600 V AC (Power); max. 63 V AC/DC (Signal)	
Protection	IP67 inserted and tightened (EN 60529)	
Temperature range	-25...+80 °C, depending on cable quality	
<b>Article No.</b>		
The composition of your article number is explained on page 3.1.i	<div style="display: flex; justify-content: space-around; align-items: center;"> <span style="border: 1px solid black; padding: 2px 5px;">7</span> <span style="border: 1px solid black; padding: 2px 5px;">0</span> <span style="border: 1px solid black; padding: 2px 5px;">0</span> <span style="border: 1px solid black; padding: 2px 5px;">0</span> <span style="font-size: 2em;">-</span> <span style="border: 1px solid black; padding: 2px 5px;">-</span> <span style="font-size: 2em;">-</span> <span style="border: 1px solid black; padding: 2px 5px;">-</span> <span style="font-size: 2em;">-</span> </div>	
	<b>1 Form</b>	<b>2 Cable Type</b>
		<b>3 Cable Length</b>
<b>Notes</b>	Other versions on request. Differing cable lengths up to 2 m can be ordered in 0.2 m steps, from 2 m on in 0.5 m steps.	

# ROUND PLUG CONNECTORS POWER

With open ended wires

– MQ15 X-Power

Male

90°



## 1 Form

**P 8 2 1 1**

Type

4-pole

Operating current: max. 13 A

Circuit diagram

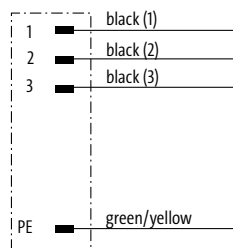

Contact layout

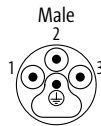

## 2 Cable Type

Jacket Color

Wire diameter 1.5 mm<sup>2</sup>

black

PVC (UL)

P22

## 3 Cable Length

1.0 m	<b>0100</b>
2.0 m	<b>0200</b>
3.0 m	<b>0300</b>
5.0 m	<b>0500</b>
10.0 m	<b>1000</b>

## Technical Data

Operating voltage	max. 600 V AC
Protection	IP67 inserted and tightened (EN 60529)
Temperature range	-25...+80 °C, depending on cable quality

## Article No.

The composition of your article number is explained on page 3.1.i

7 0 0 0

-

P 8 2 1 1

-

\_\_\_

\_\_\_

**1**

Form

**2**

Cable Type

**3**

Cable Length

Notes

Other versions on request. Differing cable lengths up to 2 m can be ordered in 0.2 m steps, from 2 m on in 0.5 m steps.

# ROUND PLUG CONNECTORS POWER

With open ended wires

– MQ15 X-Power

Female

90°



<b>1 Form</b>	<b>P 8 2 3 1</b>	<b>P 8 2 3 1</b>
	<p>Type</p> <p>4-pole</p> <p>Operating current: max. 13 A</p>	<p>4-pole</p> <p>Operating current: max. 16 A</p>
<b>Circuit diagram</b>		
<b>Contact layout</b>		
<b>2 Cable Type</b>	<b>Jacket Color</b>	<b>Jacket Color</b>
Wire diameter 1.5 mm <sup>2</sup>	black	black
PVC (UL)	P22	
PUR (UL), C-tracks	P02	
Wire diameter 2.5 mm <sup>2</sup>		
PUR (UL), C-tracks		P03
PVC (UL)		P23
<b>3 Cable Length</b>		
1.0 m	0100	
2.0 m	0200	
3.0 m	0300	
5.0 m	0500	
10.0 m	1000	
<b>Technical Data</b>		
Operating voltage	max. 600 V AC	
Protection	IP67 inserted and tightened (EN 60529)	
Temperature range	-25...+80 °C, depending on cable quality	
<b>Article No.</b>		
The composition of your article number is explained on page 3.1.i	<p><u>7 0 0 0</u> - - - - - - - - - -</p>	
	<b>1 Form</b>	<b>2 Cable Type</b>
		<b>3 Cable Length</b>
<b>Notes</b>	Other versions on request. Differing cable lengths up to 2 m can be ordered in 0.2 m steps, from 2 m on in 0.5 m steps.	



# ROUND PLUG CONNECTORS POWER

With open ended wires

– MQ15 X-Power

Female

90°



## 1 Form

**P 8 2 3 2**

**P 8 2 3 2**

Type	4-pole Operating current: max. 13 A	4-pole Operating current: max. 16 A
------	--	--

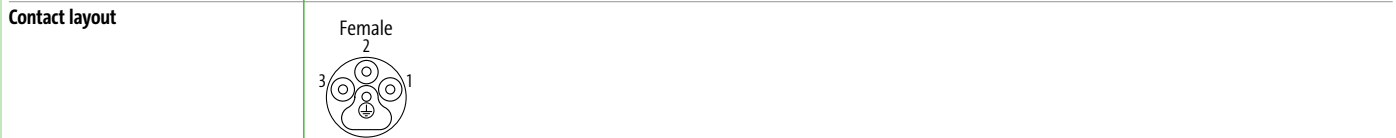
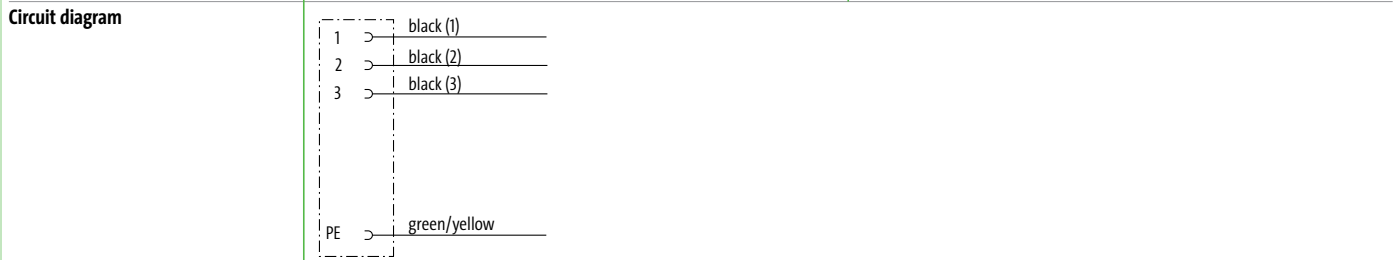

## 2 Cable Type

Jacket Color

Jacket Color

Wire diameter 1.5 mm <sup>2</sup>	black	black
PVC (UL)	P22	
PUR (UL), C-tracks	P02	
Wire diameter 2.5 mm <sup>2</sup>		
PUR (UL), C-tracks		P03
PVC (UL)		P23

## 3 Cable Length

1.0 m	0100
2.0 m	0200
3.0 m	0300
5.0 m	0500
10.0 m	1000

## Technical Data

Operating voltage	max. 600 V AC
Protection	IP67 inserted and tightened (EN 60529)
Temperature range	-25...+80 °C, depending on cable quality

## Article No.

The composition of your article number is explained on page 3.1.i

<u>7</u>	<u>0</u>	<u>0</u>	<u>0</u>	<u>0</u>	-	-	-	-
----------	----------	----------	----------	----------	---	---	---	---

**1** Form      **2** Cable Type      **3** Cable Length

Notes

Other versions on request. Differing cable lengths up to 2 m can be ordered in 0.2 m steps, from 2 m on in 0.5 m steps.

# ROUND PLUG CONNECTORS POWER

With open ended wires

– MQ15 X-Power

**Male**  
straight



**Female**  
straight



1 Form	P8301	P8321
Type	6-pole, shielded max. 16 A (Power); max. 10 A (Signal)	6-pole, shielded max. 16 A (Power); max. 10 A (Signal)
Circuit diagram		
Contact layout		
2 Cable Type	Jacket Color	Jacket Color
4×2.5 + 2×1.5 mm <sup>2</sup> PUR (UL), C-tracks	orange P11	orange P11
3 Cable Length		
1.0 m	0100	
2.0 m	0200	
3.0 m	0300	
5.0 m	0500	
10.0 m	1000	
Technical Data		
Operating voltage	max. 600 V AC (Power); max. 63 V AC/DC (Signal)	
Protection	IP67 inserted and tightened (EN 60529)	
Temperature range	-25...+80 °C, depending on cable quality	
Article No.		
The composition of your article number is explained on page 3.1.i	<span style="font-size: 24pt; font-weight: bold;">7 0 0 0</span> - - - - - - - - - -	
	<b>1</b> Form	<b>2</b> Cable Type
		<b>3</b> Cable Length
Notes		
	Other versions on request. Differing cable lengths up to 2 m can be ordered in 0.2 m steps, from 2 m on in 0.5 m steps.	

# ROUND PLUG CONNECTORS POWER

With open ended wires

– MQ15 X-Power

Male  
straight



<b>1 Form</b>	<b>P 8001</b>	<b>P 8001</b>							
	Type 4-pole, shielded Operating current: max. 13 A	Type 4-pole, shielded Operating current: max. 16 A							
Circuit diagram									
Contact layout									
<b>2 Cable Type</b>	<b>Jacket Color</b>	<b>Jacket Color</b>							
	Wire diameter 1.5 mm <sup>2</sup> PUR (UL), C-tracks	orange P12	orange						
Wire diameter 2.5 mm <sup>2</sup> PUR (UL), C-tracks		P13							
<b>3 Cable Length</b>	1.0 m	0100							
	2.0 m	0200							
	3.0 m	0300							
	5.0 m	0500							
	10.0 m	1000							
<b>Technical Data</b>									
Operating voltage	max. 600 V AC								
Protection	IP67 inserted and tightened (EN 60529)								
Temperature range	-25...+80 °C, depending on cable quality								
<b>Article No.</b>									
The composition of your article number is explained on page 3.1.i	<table border="1"> <tr> <td><u>7</u> <u>0</u> <u>0</u> <u>0</u></td> <td>-</td> <td>---</td> <td>-</td> <td>---</td> <td>-</td> <td>---</td> </tr> </table>		<u>7</u> <u>0</u> <u>0</u> <u>0</u>	-	---	-	---	-	---
<u>7</u> <u>0</u> <u>0</u> <u>0</u>	-	---	-	---	-	---			
	<b>1 Form</b>	<b>2 Cable Type</b>	<b>3 Cable Length</b>						
<b>Notes</b>	Other versions on request. Differing cable lengths up to 2 m can be ordered in 0.2 m steps, from 2 m on in 0.5 m steps.								

Round Plug Connectors Power

# ROUND PLUG CONNECTORS POWER

With open ended wires

– MQ15 X-Power

Female

straight



<b>1 Form</b>	<b>P8021</b>	<b>P8021</b>
	Type 4-pole, shielded Operating current: max. 13 A	Type 4-pole, shielded Operating current: max. 16 A
Circuit diagram		
Contact layout		
<b>2 Cable Type</b>	<b>Jacket Color</b>	<b>Jacket Color</b>
Wire diameter 1.5 mm <sup>2</sup> PUR (UL), C-tracks	orange P12	orange
Wire diameter 2.5 mm <sup>2</sup> PUR (UL), C-tracks		P13
<b>3 Cable Length</b>		
1.0 m	0100	
2.0 m	0200	
3.0 m	0300	
5.0 m	0500	
10.0 m	1000	
<b>Technical Data</b>		
Operating voltage	max. 600 V AC	
Protection	IP67 inserted and tightened (EN 60529)	
Temperature range	-25...+80 °C, depending on cable quality	
<b>Article No.</b>		
The composition of your article number is explained on page 3.1.i	<div style="display: flex; justify-content: space-around; align-items: center;"> <span style="border-bottom: 1px solid black; padding: 0 5px;">7</span> <span style="border-bottom: 1px solid black; padding: 0 5px;">0</span> <span style="border-bottom: 1px solid black; padding: 0 5px;">0</span> <span style="border-bottom: 1px solid black; padding: 0 5px;">0</span> <span style="font-size: 2em;">-</span> <span style="border-bottom: 1px solid black; padding: 0 5px;"> </span> <span style="font-size: 2em;">-</span> <span style="border-bottom: 1px solid black; padding: 0 5px;"> </span> <span style="border-bottom: 1px solid black; padding: 0 5px;"> </span> <span style="border-bottom: 1px solid black; padding: 0 5px;"> </span> </div>	
	<b>1 Form</b>	<b>2 Cable Type</b>
		<b>3 Cable Length</b>
<b>Notes</b>	Other versions on request. Differing cable lengths up to 2 m can be ordered in 0.2 m steps, from 2 m on in 0.5 m steps.	

# ROUND PLUG CONNECTORS POWER

With open ended wires

– MQ15 X-Power

Female

90°



<b>1 Form</b>	<b>P 8331</b>	<b>P 8332</b>
	Type 6-pole, shielded max. 16 A (Power); max. 10 A (Signal)	Type 6-pole, shielded max. 16 A (Power); max. 10 A (Signal)
Circuit diagram		
Contact layout		
<b>2 Cable Type</b>	<b>Jacket Color</b>	<b>Jacket Color</b>
4×2.5 + 2×1.5 mm <sup>2</sup> PUR (UL), C-tracks	orange P11	orange P11
<b>3 Cable Length</b>		
1.0 m	0100	
2.0 m	0200	
3.0 m	0300	
5.0 m	0500	
10.0 m	1000	
<b>Technical Data</b>		
Operating voltage	max. 600 V AC (Power); max. 63 V AC/DC (Signal)	
Protection	IP67 inserted and tightened (EN 60529)	
Temperature range	-25...+80 °C, depending on cable quality	
<b>Article No.</b>		
The composition of your article number is explained on page 3.1.i	<div style="display: flex; justify-content: space-around; align-items: center;"> <span style="border-bottom: 1px solid black; padding: 0 5px;">7</span> <span style="border-bottom: 1px solid black; padding: 0 5px;">0</span> <span style="border-bottom: 1px solid black; padding: 0 5px;">0</span> <span style="border-bottom: 1px solid black; padding: 0 5px;">0</span> <span style="font-size: 2em;">-</span> <span style="border-bottom: 1px solid black; padding: 0 5px;">_</span> <span style="border-bottom: 1px solid black; padding: 0 5px;">_</span> <span style="border-bottom: 1px solid black; padding: 0 5px;">_</span> <span style="font-size: 2em;">-</span> <span style="border-bottom: 1px solid black; padding: 0 5px;">_</span> <span style="border-bottom: 1px solid black; padding: 0 5px;">_</span> <span style="border-bottom: 1px solid black; padding: 0 5px;">_</span> </div>	
	<b>1 Form</b>	<b>2 Cable Type</b>
		<b>3 Cable Length</b>
<b>Notes</b>	Other versions on request. Differing cable lengths up to 2 m can be ordered in 0.2 m steps, from 2 m on in 0.5 m steps.	

Round Plug Connectors Power

# ROUND PLUG CONNECTORS POWER

With open ended wires

– MQ15 X-Power

Female

90°



<b>1 Form</b>	<b>P8031</b>	<b>P8031</b>
	Type 4-pole, shielded Operating current: max. 13 A	Type 4-pole, shielded Operating current: max. 16 A
Circuit diagram		
Contact layout		
<b>2 Cable Type</b>	<b>Jacket Color</b>	<b>Jacket Color</b>
Wire diameter 1.5 mm <sup>2</sup> PUR (UL), C-tracks	orange P12	orange
Wire diameter 2.5 mm <sup>2</sup> PUR (UL), C-tracks		P13
<b>3 Cable Length</b>		
1.0 m	0100	
2.0 m	0200	
3.0 m	0300	
5.0 m	0500	
10.0 m	1000	
<b>Technical Data</b>		
Operating voltage	max. 600 V AC	
Protection	IP67 inserted and tightened (EN 60529)	
Temperature range	-25...+80 °C, depending on cable quality	
<b>Article No.</b>		
The composition of your article number is explained on page 3.1.i	<div style="display: flex; justify-content: space-around; align-items: center;"> <span style="border-bottom: 1px solid black; padding: 0 5px;">7</span> <span style="border-bottom: 1px solid black; padding: 0 5px;">0</span> <span style="border-bottom: 1px solid black; padding: 0 5px;">0</span> <span style="border-bottom: 1px solid black; padding: 0 5px;">0</span> <span style="font-size: 2em;">-</span> <span style="border-bottom: 1px solid black; padding: 0 5px;"> </span> <span style="font-size: 2em;">-</span> <span style="border-bottom: 1px solid black; padding: 0 5px;"> </span> <span style="border-bottom: 1px solid black; padding: 0 5px;"> </span> <span style="border-bottom: 1px solid black; padding: 0 5px;"> </span> </div>	
	<b>1 Form</b>	<b>2 Cable Type</b>
		<b>3 Cable Length</b>
<b>Notes</b>	Other versions on request. Differing cable lengths up to 2 m can be ordered in 0.2 m steps, from 2 m on in 0.5 m steps.	

# ROUND PLUG CONNECTORS POWER

With open ended wires

– MQ15 X-Power

Female

90°



## 1 Form

<b>P 8 0 3 2</b>	<b>P 8 0 3 2</b>
Type 4-pole, shielded Operating current: max. 13 A	Type 4-pole, shielded Operating current: max. 16 A

Circuit diagram

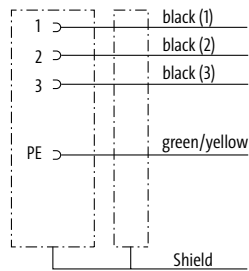

Contact layout

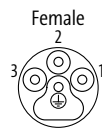

## 2 Cable Type

Cable Type	Jacket Color	Jacket Color
Wire diameter 1.5 mm <sup>2</sup> PUR (UL), C-tracks	orange P12	orange
Wire diameter 2.5 mm <sup>2</sup> PUR (UL), C-tracks		P13

## 3 Cable Length

1.0 m	0100
2.0 m	0200
3.0 m	0300
5.0 m	0500
10.0 m	1000

### Technical Data

Operating voltage	max. 600 V AC
Protection	IP67 inserted and tightened (EN 60529)
Temperature range	-25...+80 °C, depending on cable quality

### Article No.

The composition of your article number is explained on page 3.1.i

7 0 0 0 - - - - -

1

Form

2

Cable Type

3

Cable Length

Notes

Other versions on request. Differing cable lengths up to 2 m can be ordered in 0.2 m steps, from 2 m on in 0.5 m steps.

# ROUND PLUG CONNECTORS POWER

Connection cables

– MQ15 X-Power

**Male**

straight

**Female**

straight



<b>1 Form</b>	<b>P 8241</b>	<b>P 8241</b>
	4-pole Operating current: max. 13 A	4-pole Operating current: max. 16 A
<b>Circuit diagram</b>		
<b>Contact layout</b>		
<b>2 Cable Type</b>	<b>Jacket Color</b>	<b>Jacket Color</b>
Wire diameter 1.5 mm <sup>2</sup>	black	black
PVC (UL)	P22	
PUR (UL), C-tracks	P02	
Wire diameter 2.5 mm <sup>2</sup>		
PUR (UL), C-tracks		P03
PVC (UL)		P23
<b>3 Cable Length</b>		
1.0 m	0100	
2.0 m	0200	
3.0 m	0300	
5.0 m	0500	
10.0 m	1000	
<b>Technical Data</b>		
Operating voltage	max. 600 V AC	
Protection	IP67 inserted and tightened (EN 60529)	
Temperature range	-25...+80 °C, depending on cable quality	
<b>Article No.</b>		
The composition of your article number is explained on page 3.1.i	<div style="display: flex; justify-content: space-around; align-items: center;"> <span style="border: 1px solid black; padding: 2px 5px;">7</span> <span style="border: 1px solid black; padding: 2px 5px;">0</span> <span style="border: 1px solid black; padding: 2px 5px;">0</span> <span style="border: 1px solid black; padding: 2px 5px;">0</span> <span style="font-size: 2em;">-</span> <span style="border: 1px solid black; padding: 2px 5px;">-</span> <span style="font-size: 2em;">-</span> <span style="border: 1px solid black; padding: 2px 5px;">-</span> <span style="font-size: 2em;">-</span> </div>	
	<b>1 Form</b>	<b>2 Cable Type</b>
		<b>3 Cable Length</b>
<b>Notes</b>	Other versions on request. Differing cable lengths up to 2 m can be ordered in 0.2 m steps, from 2 m on in 0.5 m steps.	



# ROUND PLUG CONNECTORS POWER

## Connection cables

– MQ15 X-Power

### Male

straight

### Female

straight



1 Form	P 8141	P 8141
Type	6-pole max. 13 A (Power); max. 10 A (Signal)	6-pole max. 16 A (Power); max. 10 A (Signal)
Circuit diagram		
Contact layout		
2 Cable Type	Jacket Color	Jacket Color
Wire diameter 1.5 mm <sup>2</sup>	black	black
PVC (UL)	P24	
PUR (UL), C-tracks	P84	
Wire diameter 2.5 mm <sup>2</sup>		
PUR (UL), C-tracks		P01
PVC (UL)		P21
3 Cable Length		
1.0 m	0100	
2.0 m	0200	
3.0 m	0300	
5.0 m	0500	
10.0 m	1000	
Technical Data		
Operating voltage	max. 600 V AC (Power); max. 63 V AC/DC (Signal)	
Protection	IP67 inserted and tightened (EN 60529)	
Temperature range	-25...+80 °C, depending on cable quality	
Article No.		
The composition of your article number is explained on page 3.1.i	<div style="display: flex; justify-content: space-around; align-items: center;"> <span style="border-bottom: 1px solid black; padding: 0 5px;">7</span> <span style="border-bottom: 1px solid black; padding: 0 5px;">0</span> <span style="border-bottom: 1px solid black; padding: 0 5px;">0</span> <span style="border-bottom: 1px solid black; padding: 0 5px;">0</span> <span style="font-size: 1.5em;">-</span> <span style="border-bottom: 1px solid black; padding: 0 5px;"> </span> <span style="font-size: 1.5em;">-</span> <span style="border-bottom: 1px solid black; padding: 0 5px;"> </span> <span style="border-bottom: 1px solid black; padding: 0 5px;"> </span> <span style="border-bottom: 1px solid black; padding: 0 5px;"> </span> </div>	
	<b>1</b> Form	<b>2</b> Cable Type
		<b>3</b> Cable Length
Notes	Other versions on request. Differing cable lengths up to 2 m can be ordered in 0.2 m steps, from 2 m on in 0.5 m steps.	

Round Plug Connectors Power

# ROUND PLUG CONNECTORS POWER

Connection cables

– MQ15 X-Power

**Male**

straight

**Female**

straight



<b>1 Form</b>	<b>P8041</b>	<b>P8041</b>
	Type 4-pole, shielded Operating current: max. 13 A	Type 4-pole, shielded Operating current: max. 16 A
Circuit diagram		
Contact layout		
<b>2 Cable Type</b>	<b>Jacket Color</b>	<b>Jacket Color</b>
	Wire diameter 1.5 mm <sup>2</sup> PUR (UL), C-tracks	orange P12
Wire diameter 2.5 mm <sup>2</sup> PUR (UL), C-tracks		P13
<b>3 Cable Length</b>	1.0 m	0100
	2.0 m	0200
	3.0 m	0300
	5.0 m	0500
	10.0 m	1000
<b>Technical Data</b>	<p>Operating voltage: max. 600 V AC</p> <p>Protection: IP67 inserted and tightened (EN 60529)</p> <p>Temperature range: -25...+80 °C, depending on cable quality</p>	
<b>Article No.</b>	<p>The composition of your article number is explained on page 3.1.i</p> <p><b>7 0 0 0</b> - - - - - - - - - -</p>	
	<b>1 Form</b>	<b>2 Cable Type</b>
		<b>3 Cable Length</b>
<b>Notes</b>	<p>Other versions on request. Differing cable lengths up to 2 m can be ordered in 0.2 m steps, from 2 m on in 0.5 m steps.</p>	

# ROUND PLUG CONNECTORS POWER

## Connection cables

– MQ15 X-Power

### Male

straight

### Female

straight



## 1 Form

### P 8341

#### Type

6-pole, shielded

max. 16 A (Power); max. 10 A (Signal)

#### Circuit diagram

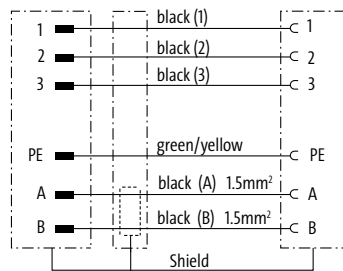

#### Contact layout

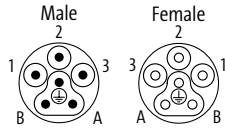

## 2 Cable Type

4×2.5 + 2×1.5 mm<sup>2</sup>

PUR (UL), C-tracks

### Jacket Color

orange

P11

## 3 Cable Length

1.0 m	0100
2.0 m	0200
3.0 m	0300
5.0 m	0500
10.0 m	1000

### Technical Data

Operating voltage	max. 600 V AC (Power); max. 63 V AC/DC (Signal)
Protection	IP67 inserted and tightened (EN 60529)
Temperature range	-25...+80 °C, depending on cable quality

### Article No.

The composition of your article number is explained on page 3.1.i

7 0 0 0

-

P 8 3 4 1

-

\_\_\_\_

\_\_\_\_

**1** Form

**2** Cable Type

**3** Cable Length

### Notes

Other versions on request. Differing cable lengths up to 2 m can be ordered in 0.2 m steps, from 2 m on in 0.5 m steps.

# ROUND PLUG CONNECTORS POWER

With open ended wires

- 7/8"

Female  
straight



Female  
90°



Approvals: 

\* only for products with UL/CSA approved cable

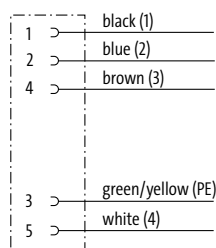
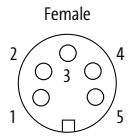
1 Form		78021	78051
Type		5-pole Power cable	5-pole Power cable
Circuit diagram			
Contact layout			
2 Cable Type		Jacket Color	Jacket Color
Wire diameter 1.0 mm <sup>2</sup> PUR/PVC		gray 965	gray 965
Wire diameter 2.5 mm <sup>2</sup> PUR (UL/CSA), robots/C-tracks		962	962
Wire diameter 1.5 mm <sup>2</sup> PUR (UL/CSA), robots/C-tracks		961	961
3 Cable Length			
1.5 m		0150	
3.0 m		0300	
5.0 m		0500	
7.5 m		0750	
10.0 m		1000	
Technical Data			
Operating voltage		max. 230/400 V AC/DC	
Protection		IP67 inserted and tightened (EN 60529)	
Temperature range		-25...+85 °C, depending on cable quality	
Article No.			
The composition of your article number is explained on page 3.1.i		<div style="display: flex; justify-content: space-around; align-items: center;"> <span style="border-bottom: 1px solid black; padding: 0 5px;">7</span> <span style="border-bottom: 1px solid black; padding: 0 5px;">0</span> <span style="border-bottom: 1px solid black; padding: 0 5px;">0</span> <span style="border-bottom: 1px solid black; padding: 0 5px;">0</span> <span style="font-size: 2em;">-</span> <span style="border-bottom: 1px solid black; padding: 0 5px;"> </span> <span style="font-size: 2em;">-</span> <span style="border-bottom: 1px solid black; padding: 0 5px;"> </span> <span style="border-bottom: 1px solid black; padding: 0 5px;"> </span> <span style="border-bottom: 1px solid black; padding: 0 5px;"> </span> </div>	
		<b>1</b> Form	<b>2</b> Cable Type
			<b>3</b> Cable Length
Notes		Other versions on request. Differing cable lengths up to 2 m can be ordered in 0.2 m steps, from 2 m on in 0.5 m steps.	

# ROUND PLUG CONNECTORS POWER

Connection cables

- 7/8"

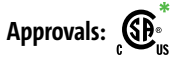

\* only for products with UL/CSA approved cable

Male  
straight

Female  
straight



Male  
90°

Female  
90°



1 Form		50021	50051
Type	5-pole Power cable	5-pole Power cable	5-pole Power cable
Circuit diagram			
Contact layout			
2 Cable Type		Jacket Color	Jacket Color
Wire diameter 1.0 mm <sup>2</sup> PUR/PVC		gray 965	gray 965
Wire diameter 2.5 mm <sup>2</sup> PUR (UL/CSA), robots/C-tracks		962	962
Wire diameter 1.5 mm <sup>2</sup> PUR (UL/CSA), robots/C-tracks		961	961
3 Cable Length			
0.3 m	0030		
0.6 m	0060		
1.0 m	0100		
1.5 m	0150		
2.0 m	0200		
Technical Data			
Operating voltage	max. 230/400 V AC/DC		
Protection	IP67 inserted and tightened (EN 60529)		
Temperature range	-25...+85 °C, depending on cable quality		
Article No.			
The composition of your article number is explained on page 3.1.i	<div style="display: flex; justify-content: space-around; align-items: center;"> <span style="border-bottom: 1px solid black; padding: 0 5px;">7</span> <span style="border-bottom: 1px solid black; padding: 0 5px;">0</span> <span style="border-bottom: 1px solid black; padding: 0 5px;">0</span> <span style="border-bottom: 1px solid black; padding: 0 5px;">0</span> <span style="font-size: 2em;">-</span> <span style="border-bottom: 1px solid black; padding: 0 5px;"> </span> <span style="font-size: 2em;">-</span> <span style="border-bottom: 1px solid black; padding: 0 5px;"> </span> <span style="border-bottom: 1px solid black; padding: 0 5px;"> </span> </div>		
	<b>1</b> Form	<b>2</b> Cable Type	<b>3</b> Cable Length
Notes		Other versions on request. Differing cable lengths up to 2 m can be ordered in 0.2 m steps, from 2 m on in 0.5 m steps.	

# ROUND PLUG CONNECTORS POWER

Field-wireable

– 7/8"

– Screw terminals

Male

straight



Male

90°



Approvals: us

1 Form	78081	meX	78101	meX	78141	meX
Type	5-pole		5-pole		5-pole	
Circuit diagram						
Sealing range (cable Ø)	6...8 mm		10...12 mm		6...8.7 mm	
Contact layout						
<b>Technical Data</b>						
Operating voltage	max. 250 V AC/DC					
Operating current per contact	max. 9 A					
Connection cross section	max. 1.5 mm <sup>2</sup>					
Sealing range (cable Ø)	6...8 mm		10...12 mm		6...8.7 mm	
Locking of ports	Screw thread 7/8" (recommended torque 1.5 Nm) self-securing					
Protection	IP67 inserted and tightened (EN 60529)					
Temperature range	-25...+85 °C					
<b>Article No.</b>						
The composition of your article number is explained on page 3.1.i	<u>7 0 0 0</u>		<u>0 0 0</u>		<u>0 0 0 0</u>	
	<b>1 Form</b>					
<b>Notes</b>	Other versions on request.					

# ROUND PLUG CONNECTORS POWER

Field-wireable

- 7/8"

- Screw terminals

Approvals:  

Female

straight



Female

90°

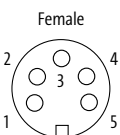

1 Form	78201	me $\times$	78221	me $\times$	78261	me $\times$
Type	5-pole		5-pole		5-pole	
Circuit diagram						
Sealing range (cable Ø)	6...8 mm		10...12 mm		6...8.7 mm	
Contact layout						
<b>Technical Data</b>						
Operating voltage	max. 250 V AC/DC					
Operating current per contact	max. 9 A					
Connection cross section	max. 1.5 mm <sup>2</sup>					
Sealing range (cable Ø)	6...8 mm		10...12 mm		6...8.7 mm	
Protection	IP67 inserted and tightened (EN 60529)					
Locking of ports	Screw thread 7/8" (recommended torque 1.5 Nm) self-securing					
Locking material	Zinc die casting, matte nickel plated					
Temperature range	-25...+85 °C					
<b>Article No.</b>						
The composition of your article number is explained on page 3.1.i	<u>7 0 0 0</u>		-	-	<u>0 0 0</u>	
					<u>0 0 0 0</u>	
			<b>1</b>	Form		
<b>Notes</b>						
Other versions on request.						

# ROUND PLUG CONNECTORS POWER

Field-wireable

- 7/8"

- IDC terminals

**Male**

straight



**Female**

straight



1 Form	78091	me	78211	me
Type	5-pole		5-pole	
Circuit diagram				
Connection cross section	0.75...1.5 mm <sup>2</sup>			
Contact layout	<p>Male</p>		<p>Female</p>	
<b>Technical Data</b>				
Operating voltage	max. 230/400 V AC/DC			
Rated surge voltage	4 kV			
Operating current per contact	max. 10 A			
Material group	IEC 60664-1, category I			
Connection cross section	0.75...1.5 mm <sup>2</sup> (conductor diameter min. 0.15 mm)			
Coding	A-coded, 5-pole			
Sealing range (cable Ø)	6.8...9.5 mm			
Wire isolation	PVC, PP, TPE			
Outer wire Ø	max. 2.8 mm			
Locking of ports	Screw thread 7/8" (recommended torque 1.5 Nm) self-securing			
Protection	IP65 and IP67 when plugged and screwed down (EN 60529)			
Locking material	Brass			
Temperature range	-40...+85 °C			
<b>Article No.</b>				
The composition of your article number is explained on page 3.1.i	<div style="display: flex; justify-content: space-around; align-items: center;"> <span style="border-bottom: 1px solid black; padding: 0 5px;">7</span> <span style="border-bottom: 1px solid black; padding: 0 5px;">0</span> <span style="border-bottom: 1px solid black; padding: 0 5px;">0</span> <span style="border-bottom: 1px solid black; padding: 0 5px;">0</span> <span style="font-size: 2em;">-</span> <span style="border-bottom: 1px solid black; padding: 0 5px;"> </span> <span style="border-bottom: 1px solid black; padding: 0 5px;"> </span> <span style="border-bottom: 1px solid black; padding: 0 5px;"> </span> <span style="border-bottom: 1px solid black; padding: 0 5px;"> </span> <span style="font-size: 2em;">-</span> <span style="border-bottom: 1px solid black; padding: 0 5px;">0</span> <span style="border-bottom: 1px solid black; padding: 0 5px;">0</span> <span style="border-bottom: 1px solid black; padding: 0 5px;">0</span> <span style="border-bottom: 1px solid black; padding: 0 5px;">0</span> </div>			
	<b>1 Form</b>			
Notes	Other versions on request.			



## ROUND PLUG CONNECTORS POWER

Connection accessories			Art-No.
	<b>Flange 7/8" male, pre-wired 0.2 m</b> 5-pole	7/8" Round Plug Connectors	<b>7000-78341-9780020</b>
	<b>Flange 7/8" female, pre-wired 0.2 m</b> 5-pole	7/8" Round Plug Connectors	<b>7000-78381-9780020</b>
	<b>Control cabinet entry system 7/8"</b>	7/8" Round Plug Connectors Ethernet CAT5	<b>7000-50111-0000000</b>
	<b>T-coupler 7/8"-7/8", female/male</b> 5-pole		<b>7000-50061-0000000</b>
Mounting accessories			Art-No.
	<b>Torque wrench set</b> 7/8" (1.5 Nm, SW22)	7/8" data connenctor moulded (IDC terminal)	<b>7000-99104-0000000</b>
	<b>Torque wrench set</b> 7/8" (1.5 Nm, SW24)	7700-XXXXX - 7/8" data connenctor moulded (screw terminals)	<b>7000-99105-0000000</b>
	<b>Torque wrench</b> 7/8" (1.5 Nm, SW22)	7/8" data connenctor moulded (IDC terminal)	<b>7000-99096-0000000</b>
	<b>Torque wrench</b> 7/8" (1.5 Nm, SW24)	7700-XXXXX - 7/8" data connenctor moulded (screw terminals)	<b>7000-99097-0000000</b>



# TPE SERIES – THE NORTH AMERICAN STANDARD

- Product range RJ45, M12, 7/8"
- High material resistance
- Reliable – 100% tested

## FROM SIGNAL AND DATA TO POWER

Our Ethernet products developed for the requirements of the North American market use shielded UL-approved cables and are approved for a voltage of 600 V.

The 4- and 8-pole cables are available in a great variety of configurations. The three cable types are suitable for moving applications, fulfil the CAT5 requirements and are resistant against different media such as welding sparks, oils and UV radiation. The S7V cable is ITC/PLTC/CMX-Outdoor-approved and suitable for PROFINET.

The MINI-A (7/8") cables are the perfect solution for current and switching circuit connections. The cables are cULus-listed. Available with 3, 4 and 5 pole and all configurations of head types. The range of 600 V cables in AWG 16 includes a TC-ER-approved TPR variant with flame resistance FT4 and a halogen-free PUR type.

## Signal

**M12 male**

- Straight
- 90°

*Page 3.11.1*

**M12 female**

- Straight
- 90°

*Page 3.11.3*

**M12 male**

- Straight
- 90°

**M12 female**

- Straight
- 90°

*Page 3.11.5*

## Data



### M12 male (shielded)

- Straight
- 90°

EtherNet/IP  
PROFINET  
EtherCAT

Page 3.11.9



### M12 female flange plug (shielded)

- Straight

EtherNet/IP  
PROFINET

Page 3.11.11



### RJ45 male (shielded)

- Straight

EtherNet/IP  
PROFINET

Page 3.11.12

EtherNet/IP



EtherCAT

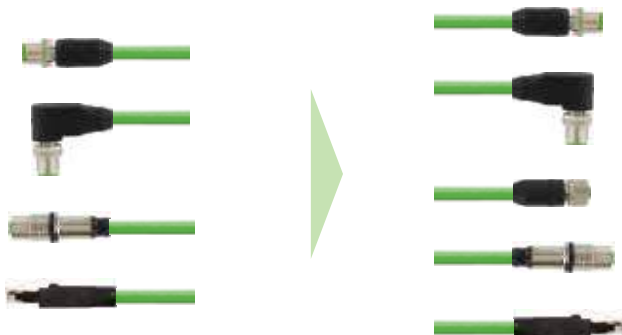

### M12 male (shielded)

- Straight
- 90°

### M12 female flange plug (shielded)

- Straight

### RJ45 male (shielded)

- Straight

### M12 male (shielded)

- Straight
- 90°

### M12 female (shielded)

- Straight

### M12 female flange plug (shielded)

- Straight

### RJ45 male (shielded)

- Straight

Page 3.11.17

## Power

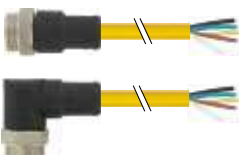

### 7/8" MINI male

- Straight
- 90°

Page 3.11.36

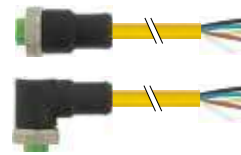

### 7/8" MINI female

- Straight
- 90°

Page 3.11.42

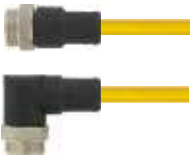

### 7/8" MINI male

- Straight
- 90°

### 7/8" MINI female

- Straight
- 90°

Page 3.11.48

# TPE SERIES - THE NORTH AMERICAN STANDARD

With open ended wires M12

– ITC, PLTC cable

– Signal

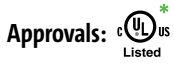

\* only for products with UL/CSA approved cable

**Male**

straight



**Male**

90°

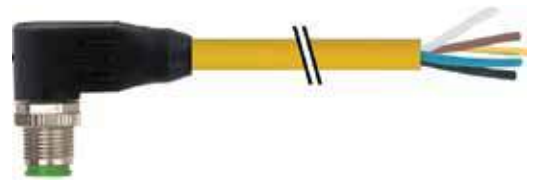

1 Form		12021		12101		
Type		4-pole		4-pole		
Circuit diagram						
Contact layout		<p>Male</p>				
2 Cable Type		Jacket Color		Jacket Color		
Wire diameter 0.75 mm <sup>2</sup>		yellow		yellow		
TPE (UL/CSA), welding spark, C-tracks		150		150		
3 Cable Length						
1.5 m		0150				
3.0 m		0300				
5.0 m		0500				
7.5 m		0750				
10.0 m		1000				
Technical Data						
Operating voltage		max. 250 V AC/DC				
Protection		IP65, IP66K, IP67 inserted and tightened (EN 60529)				
Temperature range		-25...+85 °C, depending on cable quality				
Article No.						
The composition of your article number is explained on page 3.1.i		<u>7 7 0 0</u>		- - - - -		
		- - - - -		- - - - -		
		<b>1</b>	<b>Form</b>		<b>2</b>	
		<b>Cable Type</b>		<b>3</b>	<b>Cable Length</b>	
Notes						
		Other versions on request. Differing cable lengths up to 2 m can be ordered in 0.2 m steps, from 2 m on in 0.5 m steps.				

# TPE SERIES - THE NORTH AMERICAN STANDARD

With open ended wires M12

- ITC, PLTC cable

- Signal

Approvals: 

\* only for products with UL/CSA approved cable

Male

straight



Male

90°

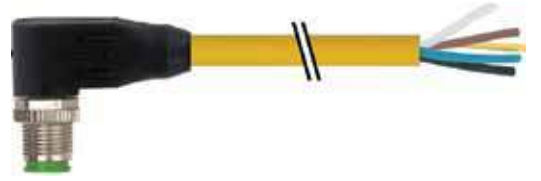

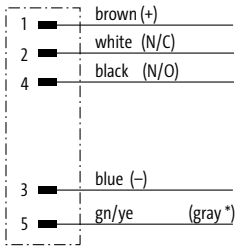
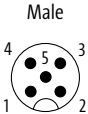
<b>1 Form</b>	<b>12041</b>	<b>12121</b>
	Type 5-pole	Type 5-pole
Circuit diagram	 <p>(* for cable type 162)</p>	
	Contact layout	
		
<b>2 Cable Type</b>	<b>Jacket Color</b>	<b>Jacket Color</b>
Wire diameter 0.75 mm <sup>2</sup> TPE (UL/CSA), welding spark, C-tracks	yellow 161 (162)	yellow 161 (162)
<b>3 Cable Length</b>		
1.5 m	0150	
3.0 m	0300	
5.0 m	0500	
7.5 m	0750	
10.0 m	1000	
<b>Technical Data</b>		
Operating voltage	max. 125 V AC/DC	
Protection	IP65, IP66K, IP67 inserted and tightened (EN 60529)	
Temperature range	-25...+85 °C, depending on cable quality	
<b>Article No.</b>		
The composition of your article number is explained on page 3.1.i	<div style="display: flex; justify-content: space-around; align-items: center;"> <span><u>7</u> <u>7</u> <u>0</u> <u>0</u></span> <span>-</span> <span>_____</span> <span>-</span> <span>_____</span> </div>	
	<b>1 Form</b>	<b>2 Cable Type</b>
		<b>3 Cable Length</b>
<b>Notes</b>	Other versions on request. Differing cable lengths up to 2 m can be ordered in 0.2 m steps, from 2 m on in 0.5 m steps.	

TPE Series - The North American standard

**TPE SERIES - THE NORTH AMERICAN STANDARD**

With open ended wires M12

- ITC, PLTC cable
- Signal

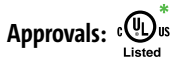

\* only for products with UL/CSA approved cable

Female  
straight



Female  
90°

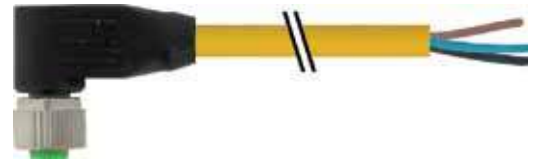

<b>1 Form</b>	<b>12221</b>	<b>12341</b>
Type	4-pole	
Circuit diagram		
Contact layout	<p>Female</p>	
<b>2 Cable Type</b>	<b>Jacket Color</b>	<b>Jacket Color</b>
Wire diameter 0.75 mm <sup>2</sup> TPE (UL/CSA), welding spark, C-tracks	<b>yellow</b> <b>150</b>	<b>yellow</b> <b>150</b>
<b>3 Cable Length</b>		
1.5 m	<b>0150</b>	
3.0 m	<b>0300</b>	
5.0 m	<b>0500</b>	
7.5 m	<b>0750</b>	
10.0 m	<b>1000</b>	
<b>Technical Data</b>		
Operating voltage	max. 250 V AC/DC	
Protection	IP65, IP66K, IP67 inserted and tightened (EN 60529)	
Temperature range	-25...+85 °C, depending on cable quality	
<b>Article No.</b>		
The composition of your article number is explained on page 3.1.i	<b>7 7 0 0</b> - - - - - - - - - -	- - - - -
	<b>1 Form</b>	<b>2 Cable Type</b>
		<b>3 Cable Length</b>
<b>Notes</b>		
	Other versions on request. Differing cable lengths up to 2 m can be ordered in 0.2 m steps, from 2 m on in 0.5 m steps.	

TPE Series - The North American standard

# TPE SERIES - THE NORTH AMERICAN STANDARD

With open ended wires M12

- ITC, PLTC cable

- Signal

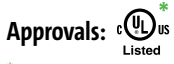

\* only for products with UL/CSA approved cable

Female  
straight



Female  
90°

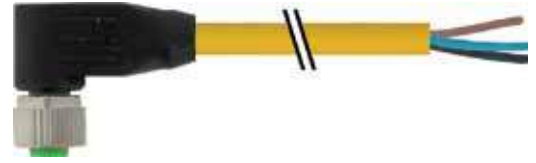

1 Form		12241	12361
Type		5-pole	5-pole
Circuit diagram	<p>(* for cable type 162)</p>		
Contact layout	<p>Female</p>		
2 Cable Type		Jacket Color	Jacket Color
Wire diameter 0.75 mm <sup>2</sup>		yellow	yellow
TPE (UL/CSA), welding spark, C-tracks		161 (162)	161 (162)
3 Cable Length			
1.5 m		0150	
3.0 m		0300	
5.0 m		0500	
7.5 m		0750	
10.0 m		1000	
Technical Data			
Operating voltage		max. 125 V AC/DC	
Protection		IP65, IP66K, IP67 inserted and tightened (EN 60529)	
Temperature range		-25...+85 °C, depending on cable quality	
Article No.			
The composition of your article number is explained on page 3.1.i		<div style="display: flex; align-items: center; gap: 10px;"> <span style="border-bottom: 1px solid black; padding: 0 5px;">7</span> <span style="border-bottom: 1px solid black; padding: 0 5px;">7</span> <span style="border-bottom: 1px solid black; padding: 0 5px;">0</span> <span style="border-bottom: 1px solid black; padding: 0 5px;">0</span> <span style="font-size: 2em;">-</span> <span style="border-bottom: 1px dashed black; padding: 0 5px;"> </span> <span style="font-size: 2em;">-</span> <span style="border-bottom: 1px dashed black; padding: 0 5px;"> </span> <span style="border-bottom: 1px dashed black; padding: 0 5px;"> </span> </div>	<div style="border-bottom: 1px dashed black; padding: 0 5px;"> </div>
		<b>1</b> Form	<b>2</b> Cable Type
			<b>3</b> Cable Length
Notes		Other versions on request. Differing cable lengths up to 2 m can be ordered in 0.2 m steps, from 2 m on in 0.5 m steps.	

# TPE SERIES - THE NORTH AMERICAN STANDARD

## Connection cables M12 - M12

- ITC, PLTC cable
- Signal

Male  
straight

Female  
straight

Male  
straight

Female  
90°

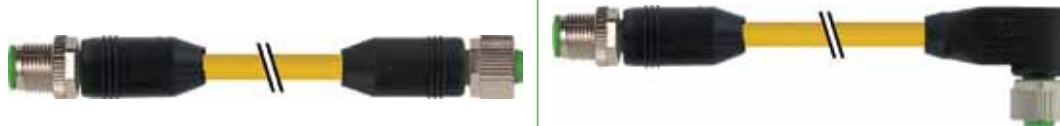

Approvals: 

\* only for products with UL/CSA approved cable

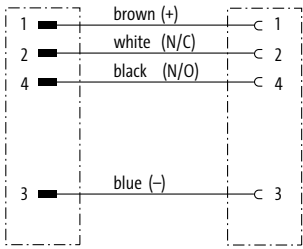
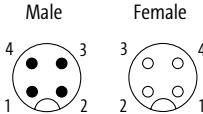
<b>1 Form</b>	<b>40021</b>	<b>40121</b>
Type	4-pole	4-pole
Circuit diagram		
Contact layout		
<b>2 Cable Type</b>	<b>Jacket Color</b>	<b>Jacket Color</b>
Wire diameter 0.75 mm <sup>2</sup> TPE (UL/CSA), welding spark, C-tracks	yellow 150	yellow 150
<b>3 Cable Length</b>		
0.3 m	0030	
0.6 m	0060	
1.0 m	0100	
1.5 m	0150	
2.0 m	0200	
<b>Technical Data</b>		
Operating voltage	max. 250 V AC/DC	
Protection	IP65, IP66K, IP67 inserted and tightened (EN 60529)	
Temperature range	-25...+85 °C, depending on cable quality	
<b>Article No.</b>		
The composition of your article number is explained on page 3.1.i	<div style="display: flex; justify-content: space-around; align-items: center;"> <span style="border-bottom: 1px solid black; padding: 0 5px;">7</span> <span style="border-bottom: 1px solid black; padding: 0 5px;">7</span> <span style="border-bottom: 1px solid black; padding: 0 5px;">0</span> <span style="border-bottom: 1px solid black; padding: 0 5px;">0</span> <span style="font-size: 2em;">-</span> <span style="border-bottom: 1px dashed black; width: 50px; display: inline-block;"></span> <span style="font-size: 2em;">-</span> <span style="border-bottom: 1px dashed black; width: 50px; display: inline-block;"></span> <span style="border-bottom: 1px dashed black; width: 50px; display: inline-block;"></span> </div>	
	<b>1 Form</b>	<b>2 Cable Type</b>
		<b>3 Cable Length</b>
<b>Notes</b>	Other versions on request. Differing cable lengths up to 2 m can be ordered in 0.2 m steps, from 2 m on in 0.5 m steps.	



# TPE SERIES - THE NORTH AMERICAN STANDARD

## Connection cables M12 - M12

- ITC, PLTC cable
- Signal

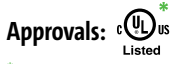

\* only for products with UL/CSA approved cable



<b>1 Form</b>	<b>40201</b>	<b>40261</b>								
	4-pole	4-pole								
<b>Circuit diagram</b>										
<b>Contact layout</b>										
<b>2 Cable Type</b>	<b>Jacket Color</b>	<b>Jacket Color</b>								
Wire diameter 0.75 mm <sup>2</sup> TPE (UL/CSA), welding spark, C-tracks	yellow 150	yellow 150								
<b>3 Cable Length</b>										
0.3 m	0030									
0.6 m	0060									
1.0 m	0100									
1.5 m	0150									
2.0 m	0200									
<b>Technical Data</b>										
Operating voltage	max. 250 V AC/DC									
Protection	IP65, IP66K, IP67 inserted and tightened (EN 60529)									
Temperature range	-25...+85 °C, depending on cable quality									
<b>Article No.</b>										
The composition of your article number is explained on page 3.1.i	<table border="1"> <tr> <td><u>7</u></td> <td><u>7</u></td> <td><u>0</u></td> <td><u>0</u></td> <td>-</td> <td>-</td> <td>-</td> <td>-</td> </tr> </table>		<u>7</u>	<u>7</u>	<u>0</u>	<u>0</u>	-	-	-	-
<u>7</u>	<u>7</u>	<u>0</u>	<u>0</u>	-	-	-	-			
	<b>1 Form</b>	<b>2 Cable Type</b>	<b>3 Cable Length</b>							
<b>Notes</b>	Other versions on request. Differing cable lengths up to 2 m can be ordered in 0.2 m steps, from 2 m on in 0.5 m steps.									

# TPE SERIES - THE NORTH AMERICAN STANDARD

## Connection cables M12 - M12

– ITC, PLTC cable

– Signal

**Male**

straight

**Female**

straight

**Male**

straight

**Female**

90°



Approvals:  <sup>\*</sup>  
Listed

\* only for products with UL/CSA approved cable

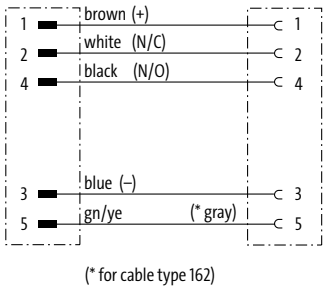
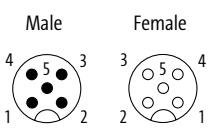
<b>1 Form</b>	<b>40041</b>	<b>40141</b>
Type	5-pole	5-pole
Circuit diagram		
Contact layout		
<b>2 Cable Type</b>	<b>Jacket Color</b>	<b>Jacket Color</b>
Wire diameter 0.75 mm <sup>2</sup> TPE (UL/CSA), welding spark, C-tracks	yellow 161 (162)	yellow 161 (162)
<b>3 Cable Length</b>		
0.3 m	0030	
0.6 m	0060	
1.0 m	0100	
1.5 m	0150	
2.0 m	0200	
<b>Technical Data</b>		
Operating voltage	max. 125 V AC/DC	
Protection	IP65, IP66K, IP67 inserted and tightened (EN 60529)	
Temperature range	-25...+85 °C, depending on cable quality	
<b>Article No.</b>		
The composition of your article number is explained on page 3.1.i	<div style="display: flex; justify-content: space-around; align-items: center;"> <span style="border-bottom: 1px solid black; padding: 0 5px;">7</span> <span style="border-bottom: 1px solid black; padding: 0 5px;">7</span> <span style="border-bottom: 1px solid black; padding: 0 5px;">0</span> <span style="border-bottom: 1px solid black; padding: 0 5px;">0</span> <span style="font-size: 2em;">-</span> <span style="border-bottom: 1px dashed black; padding: 0 5px;"> </span> <span style="font-size: 2em;">-</span> <span style="border-bottom: 1px dashed black; padding: 0 5px;"> </span> <span style="border-bottom: 1px dashed black; padding: 0 5px;"> </span> <span style="border-bottom: 1px dashed black; padding: 0 5px;"> </span> </div>	
	<b>1 Form</b>	<b>2 Cable Type</b>
		<b>3 Cable Length</b>
<b>Notes</b>	Other versions on request. Differing cable lengths up to 2 m can be ordered in 0.2 m steps, from 2 m on in 0.5 m steps.	

# TPE SERIES - THE NORTH AMERICAN STANDARD

## Connection cables M12 - M12

- ITC, PLTC cable
- Signal

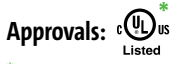

\* only for products with UL/CSA approved cable



<b>1 Form</b>	<b>4 0 2 2 1</b>	<b>4 0 2 8 1</b>
	Type 5-pole	Type 5-pole
Circuit diagram		
Contact layout		
<b>2 Cable Type</b>	<b>Jacket Color</b>	<b>Jacket Color</b>
Wire diameter 0.75 mm <sup>2</sup> TPE (UL/CSA), welding spark, Ctracks	yellow 161 (162)	yellow 161 (162)
<b>3 Cable Length</b>		
0.3 m	0030	
0.6 m	0060	
1.0 m	0100	
1.5 m	0150	
2.0 m	0200	
<b>Technical Data</b>		
Operating voltage	max. 125 V AC/DC	
Protection	IP65, IP66K, IP67 inserted and tightened (EN 60529)	
Temperature range	-25...+85 °C, depending on cable quality	
<b>Article No.</b>		
The composition of your article number is explained on page 3.1.i	<div style="display: flex; justify-content: space-around; align-items: center;"> <span><u>7</u> <u>7</u> <u>0</u> <u>0</u></span> <span>-</span> <span>---</span> <span>-</span> <span>---</span> </div>	
	<b>1 Form</b>	<b>2 Cable Type</b>
		<b>3 Cable Length</b>
<b>Notes</b>	Other versions on request. Differing cable lengths up to 2 m can be ordered in 0.2 m steps, from 2 m on in 0.5 m steps.	

# TPE SERIES - THE NORTH AMERICAN STANDARD

with open ended wires RJ45

– CMX-Outdoor

– Data

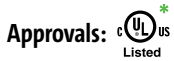

\* only for products with UL/CSA approved cable

**Male**  
straight  
ITC, PLTC cable



**Male**  
straight



1 Form		14541		14541	
Type	4-pole, shielded D-coded			4-pole, shielded D-coded	
Circuit diagram					
Contact layout	<p>Male</p>				
2 Cable Type		Jacket Color		Jacket Color	
2x2x0.34 mm <sup>2</sup> TPE (UL/CSA), robots/C-tracks		green S7V		blue	
2x2x0.25 mm <sup>2</sup> TPE (UL/CSA), robots/C-tracks				S4U	
3 Cable Length					
1.5 m	0150				
3.0 m	0300				
5.0 m	0500				
7.5 m	0750				
10.0 m	1000				
Technical Data					
Operating voltage	max. 60 V DC				
Protection	IP65, IP66K, IP67 inserted and tightened (EN 60529)				
Temperature range	-25...+85 °C, depending on cable quality				
Article No.					
The composition of your article number is explained on page 3.1.i		7 7 0 0	-	-	-
		1 Form	2 Cable Type	3 Cable Length	
Notes		Other versions on request. Differing cable lengths up to 2 m can be ordered in 0.2 m steps, from 2 m on in 0.5 m steps.			

# TPE SERIES - THE NORTH AMERICAN STANDARD

with open ended wires RJ45

– CMX-Outdoor

– Data

**PROFI**® EtherNet/IP™  
**NET**

Approvals:  <sup>\*</sup>  
Listed



\* only for products with UL/CSA approved cable

**Male**  
90°  
ITC, PLTC cable



**Male**  
90°

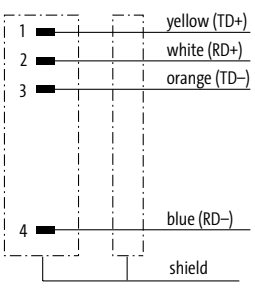
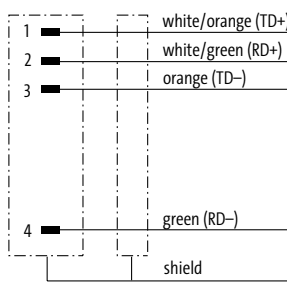

<b>1 Form</b>	<b>14561</b>	<b>14561</b>										
	<p><b>Type</b> 4-pole, shielded D-coded</p> <p><b>Circuit diagram</b></p> 	<p><b>Type</b> 4-pole, shielded D-coded</p> <p><b>Circuit diagram</b></p> 										
<b>Contact layout</b>	<p>Male</p> 											
<b>2 Cable Type</b>	<b>Jacket Color</b>	<b>Jacket Color</b>										
	<p>2x2x0.34 mm<sup>2</sup> TPE (UL/CSA), robots/C-tracks</p> <p>2x2x0.25 mm<sup>2</sup> TPE (UL/CSA), robots/C-tracks</p>	<p>green S7V</p>	<p>blue S4U</p>									
<b>3 Cable Length</b>	<table border="1"> <tr><td>1.5 m</td><td>0150</td></tr> <tr><td>3.0 m</td><td>0300</td></tr> <tr><td>5.0 m</td><td>0500</td></tr> <tr><td>7.5 m</td><td>0750</td></tr> <tr><td>10.0 m</td><td>1000</td></tr> </table>		1.5 m	0150	3.0 m	0300	5.0 m	0500	7.5 m	0750	10.0 m	1000
1.5 m	0150											
3.0 m	0300											
5.0 m	0500											
7.5 m	0750											
10.0 m	1000											
<b>Technical Data</b>	<p>Operating voltage: max. 60 V DC</p> <p>Protection: IP65, IP66K, IP67 inserted and tightened (EN 60529)</p> <p>Temperature range: -25...+85 °C, depending on cable quality</p>											
<b>Article No.</b>	<p>The composition of your article number is explained on page 3.1.i</p> <p><u>7</u> <u>7</u> <u>0</u> <u>0</u> - - - - -</p>											
	<b>1 Form</b>	<b>2 Cable Type</b>										
		<b>3 Cable Length</b>										
<b>Notes</b>	<p>Other versions on request. Differing cable lengths up to 2 m can be ordered in 0.2 m steps, from 2 m on in 0.5 m steps.</p>											

# TPE SERIES - THE NORTH AMERICAN STANDARD

with open ended wires RJ45

– CMX-Outdoor

– Data



**Flange female**

ITC, PLTC cable



**Flange female**



1 Form		14511		14511	
Type	4-pole, shielded			4-pole, shielded	
	D-coded			D-coded	
	Rear mounting			Rear mounting	
Circuit diagram					
Contact layout	Female 				
2 Cable Type	<b>Jacket Color</b>			<b>Jacket Color</b>	
	2x2x0.34 mm <sup>2</sup> TPE (UL/CSA), robots/C-tracks	green		blue	
2x2x0.25 mm <sup>2</sup> TPE (UL/CSA), robots/C-tracks	S7V		S4U		
3 Cable Length	1.5 m	0150			
	3.0 m	0300			
	5.0 m	0500			
	7.5 m	0750			
	10.0 m	1000			
<b>Technical Data</b>					
Operating voltage	max. 60 V DC				
Protection	IP67 inserted and tightened (EN 60529)				
Temperature range	-25...+85 °C, depending on cable quality				
<b>Article No.</b>					
The composition of your article number is explained on page 3.1.i	7 7 0 0		-	-	-
	1 Form		2 Cable Type		3 Cable Length
<b>Notes</b>					
Other versions on request. Differing cable lengths up to 2 m can be ordered in 0.2 m steps, from 2 m on in 0.5 m steps.					

# TPE SERIES - THE NORTH AMERICAN STANDARD

with open ended wires RJ45

– CMX-Outdoor

– Data

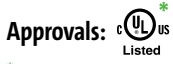

\* only for products with UL/CSA approved cable

**Male**  
straight  
ITC, PLTC cable



**Male**  
straight



1 Form		74101	74101
Type		4-pole, shielded	4-pole, shielded
Circuit diagram			
Contact layout		<p>Male</p>	
2 Cable Type		Jacket Color	Jacket Color
2x2x0.34 mm <sup>2</sup> TPE (UL/CSA), robots/C-tracks		green S7V	blue
2x2x0.25 mm <sup>2</sup> TPE (UL/CSA), robots/C-tracks			S4U
3 Cable Length			
1.5 m		0150	
3.0 m		0300	
5.0 m		0500	
7.5 m		0750	
10.0 m		1000	
Technical Data			
Operating voltage		max. 60 V DC	
Protection		IP20 inserted and tightened (EN 60529)	
Temperature range		-25...+85 °C, depending on cable quality	
Article No.			
The composition of your article number is explained on page 3.1.i		7 7 0 0	- - - - -
		1 Form	2 Cable Type
			3 Cable Length
Notes		Other versions on request. Differing cable lengths up to 2 m can be ordered in 0.2 m steps, from 2 m on in 0.5 m steps.	

TPE Series - The North American standard

# TPE SERIES - THE NORTH AMERICAN STANDARD

With open ended wires M12

– CMX-Outdoor

– Data



**Male**  
straight



**Male**  
90°



<b>1 Form</b>	<b>17541</b>	<b>17561</b>
Type	8-pole, shielded	8-pole, shielded
Circuit diagram		
Contact layout		
<b>2 Cable Type</b>	<b>Jacket Color</b>	<b>Jacket Color</b>
4x2x0.25 mm <sup>2</sup> TPE (UL/CSA), robots/Ctracks	blue S4W	blue S4W
<b>3 Cable Length</b>		
1.5 m	0150	
3.0 m	0300	
5.0 m	0500	
7.5 m	0750	
10.0 m	1000	
<b>Technical Data</b>		
Operating voltage	max. 60 V AC/DC	
Protection	IP65, IP66K, IP67 inserted and tightened (EN 60529)	
Temperature range	-25...+85 °C, depending on cable quality	
<b>Article No.</b>		
The composition of your article number is explained on page 3.1.i	<div style="display: flex; justify-content: space-around; align-items: center;"> <span style="border-bottom: 1px solid black; padding: 0 5px;">7</span> <span style="border-bottom: 1px solid black; padding: 0 5px;">7</span> <span style="border-bottom: 1px solid black; padding: 0 5px;">0</span> <span style="border-bottom: 1px solid black; padding: 0 5px;">0</span> <span style="font-size: 2em;">-</span> <span style="border-bottom: 1px solid black; padding: 0 5px;"> </span> <span style="font-size: 2em;">-</span> <span style="border-bottom: 1px solid black; padding: 0 5px;"> </span> <span style="border-bottom: 1px solid black; padding: 0 5px;"> </span> <span style="border-bottom: 1px solid black; padding: 0 5px;"> </span> </div>	
	<b>1 Form</b>	<b>2 Cable Type</b>
		<b>3 Cable Length</b>
<b>Notes</b>	Other versions on request. Differing cable lengths up to 2 m can be ordered in 0.2 m steps, from 2 m on in 0.5 m steps.	



# TPE SERIES - THE NORTH AMERICAN STANDARD

With open ended wires M12

– CMX-Outdoor

– Data

**PROFI**® EtherNet/IP™  
**NET**

Female  
straight



## 1 Form

**17581**

Type

8-pole, shielded

Circuit diagram

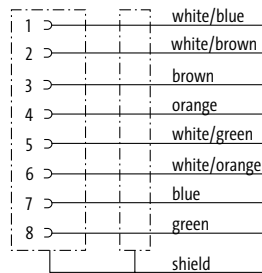

Contact layout

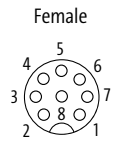

## 2 Cable Type

Jacket Color

4x2x0.25 mm<sup>2</sup>  
TPE (UL/CSA), robots/C-tracks

blue  
S4W

## 3 Cable Length

1.5 m	0150
3.0 m	0300
5.0 m	0500
7.5 m	0750
10.0 m	1000

## Technical Data

Operating voltage	max. 60 V AC/DC
Protection	IP65, IP66K, IP67 inserted and tightened (EN 60529)
Temperature range	-25...+85 °C, depending on cable quality

## Article No.

The composition of your article number is explained on page 3.1.i

7 7 0 0

-

1 7 5 8 1

-

---

---

**1** Form

**2** Cable Type

**3** Cable Length

Notes

Other versions on request. Differing cable lengths up to 2 m can be ordered in 0.2 m steps, from 2 m on in 0.5 m steps.

# TPE SERIES - THE NORTH AMERICAN STANDARD

With open ended wires M12

– CMX-Outdoor

– Data

**PROFI**® EtherNet/IP™  
**NET**

Flange female



<b>1 Form</b>		<b>17511</b>	
Type	8-pole, shielded Rear mounting		
Circuit diagram			
Contact layout	Female 		
<b>2 Cable Type</b>		<b>Jacket Color</b>	
4x2x0.25 mm <sup>2</sup> TPE (UL/CSA), robots/Ctracks	<div style="background-color: #00a0e3; color: white; padding: 2px;">blue</div> <div style="background-color: #00a0e3; color: white; padding: 2px;">S4W</div>		
<b>3 Cable Length</b>			
1.5 m	<b>0150</b>		
3.0 m	<b>0300</b>		
5.0 m	<b>0500</b>		
7.5 m	<b>0750</b>		
10.0 m	<b>1000</b>		
<b>Technical Data</b>			
Operating voltage	max. 60 V AC/DC		
Protection	IP67 inserted and tightened (EN 60529)		
Temperature range	-25...+85 °C, depending on cable quality		
<b>Article No.</b>			
The composition of your article number is explained on page 3.1.i	<div style="display: flex; justify-content: space-around; align-items: center;"> <span style="border-bottom: 1px solid black; padding: 0 5px;">7</span> <span style="border-bottom: 1px solid black; padding: 0 5px;">7</span> <span style="border-bottom: 1px solid black; padding: 0 5px;">0</span> <span style="border-bottom: 1px solid black; padding: 0 5px;">0</span> <span style="font-size: 2em;">-</span> <span style="border-bottom: 1px solid black; padding: 0 5px;">1</span> <span style="border-bottom: 1px solid black; padding: 0 5px;">7</span> <span style="border-bottom: 1px solid black; padding: 0 5px;">5</span> <span style="border-bottom: 1px solid black; padding: 0 5px;">1</span> <span style="border-bottom: 1px solid black; padding: 0 5px;">1</span> <span style="font-size: 2em;">-</span> <span style="border-bottom: 1px solid black; padding: 0 5px;">_</span> <span style="border-bottom: 1px solid black; padding: 0 5px;">_</span> <span style="border-bottom: 1px solid black; padding: 0 5px;">_</span> <span style="border-bottom: 1px solid black; padding: 0 5px;">_</span> </div>		
	<b>1</b>	<b>2</b>	<b>3</b>
	Form	Cable Type	Cable Length
<b>Notes</b>	Other versions on request. Differing cable lengths up to 2 m can be ordered in 0.2 m steps, from 2 m on in 0.5 m steps.		

# TPE SERIES - THE NORTH AMERICAN STANDARD

with open ended wires RJ45

– CMX-Outdoor

– Data

**PROFI**® EtherNet/IP™  
**NET**

**Male**  
straight



## 1 Form 74118

Type 8-pole, shielded

Circuit diagram	
1	white/orange
2	orange
3	white/green
4	blue
5	white/blue
6	green
7	white/brown
8	brown
	shield

Contact layout Male



## 2 Cable Type Jacket Color

4x2x0.25 mm <sup>2</sup>	blue
TPE (UL/CSA), robots/C-tracks	S4W

## 3 Cable Length

1.5 m	0150
3.0 m	0300
5.0 m	0500
7.5 m	0750
10.0 m	1000

## Technical Data

Operating voltage	max. 60 V DC
Protection	IP20 inserted and tightened (EN 60529)
Temperature range	-25...+85 °C, depending on cable quality

## Article No.

The composition of your article number is explained on page 3.1.i	<u>7</u> <u>7</u> <u>0</u> <u>0</u> - <u>7</u> <u>4</u> <u>1</u> <u>1</u> <u>8</u> - _ _ _ _
---	--

**1** Form **2** Cable Type **3** Cable Length

Notes Other versions on request. Differing cable lengths up to 2 m can be ordered in 0.2 m steps, from 2 m on in 0.5 m steps.

# TPE SERIES - THE NORTH AMERICAN STANDARD

Connection cables M12 - M12

– CMX-Outdoor

– Data

EtherNet/IP **PROFI**  
**NET**

Approvals:  <sup>\*</sup>  
Listed

\* only for products with UL/CSA approved cable

**Male**  
straight  
ITC, PLTC cable

**Male**  
straight

**Male**  
straight

**Male**  
straight

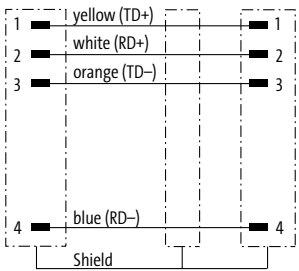
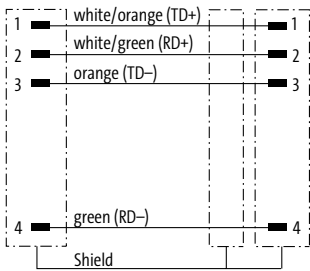
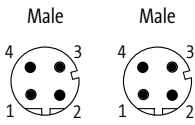

1 Form		4 4 5 1 1		4 4 5 1 1	
Type	4-pole, shielded D-coded			4-pole, shielded D-coded	
Circuit diagram					
Contact layout					
2 Cable Type		Jacket Color		Jacket Color	
2x2x0.34 mm <sup>2</sup> TPE (UL/CSA), robots/C-tracks		green S7V		blue	
2x2x0.25 mm <sup>2</sup> TPE (UL/CSA), robots/C-tracks				S4U	
3 Cable Length					
1.5 m		0150			
3.0 m		0300			
5.0 m		0500			
7.5 m		0750			
10.0 m		1000			
Technical Data					
Operating voltage		max. 60 V DC			
Protection		IP65, IP66K, IP67 inserted and tightened (EN 60529)			
Temperature range		-25...+85 °C, depending on cable quality			
Article No.					
The composition of your article number is explained on page 3.1.i		7 7 0 0 - - - - -		- - - - -	
		1 Form		2 Cable Type	
				3 Cable Length	
Notes		Other versions on request. Differing cable lengths up to 2 m can be ordered in 0.2 m steps, from 2 m on in 0.5 m steps.			

# TPE SERIES - THE NORTH AMERICAN STANDARD

## Connection cables M12 - M12

– CMX-Outdoor

– Data

**PROFI**® EtherNet/IP™  
**NET**

Approvals:  <sup>\*</sup>  
Listed

\* only for products with UL/CSA approved cable

**Male**  
straight  
ITC, PLTC cable



**Male**  
90°

**Male**  
straight

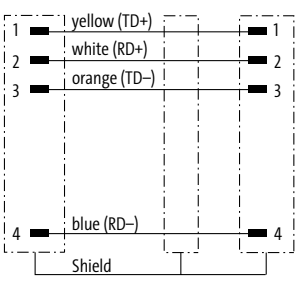
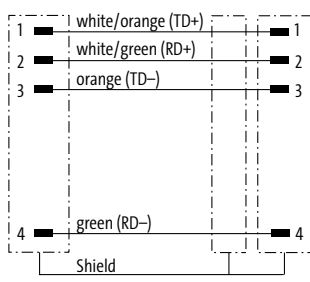
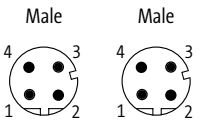
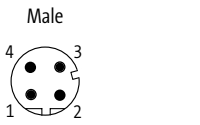

**Male**  
90°

<b>1 Form</b>	<b>4 4 5 4 1</b>	<b>4 4 5 4 1</b>
	<p>Type</p> <p>4-pole, shielded</p> <p>D-coded</p>	<p>Type</p> <p>4-pole, shielded</p> <p>D-coded</p>
<b>Circuit diagram</b>		
<b>Contact layout</b>	<p>Male</p> 	<p>Male</p> 
<b>2 Cable Type</b>	<b>Jacket Color</b>	<b>Jacket Color</b>
	<p>2x2x0.34 mm<sup>2</sup> TPE (UL/CSA), robots/C-tracks</p> <p>2x2x0.25 mm<sup>2</sup> TPE (UL/CSA), robots/C-tracks</p>	<p>green</p> <p>S7V</p>
<b>3 Cable Length</b>	<p>1.5 m    <b>0150</b></p> <p>3.0 m    <b>0300</b></p> <p>5.0 m    <b>0500</b></p> <p>7.5 m    <b>0750</b></p> <p>10.0 m   <b>1000</b></p>	
<b>Technical Data</b>	<p>Operating voltage    max. 60 V DC</p> <p>Protection            IP65, IP66K, IP67 inserted and tightened (EN 60529)</p> <p>Temperature range    -25...+85 °C, depending on cable quality</p>	
<b>Article No.</b>	<p>The composition of your article number is explained on page 3.1.i</p> <p><b>7 7 0 0</b> - - - - -</p>	
	<b>1 Form</b>	<b>2 Cable Type</b>
		<b>3 Cable Length</b>
<b>Notes</b>	<p>Other versions on request. Differing cable lengths up to 2 m can be ordered in 0.2 m steps, from 2 m on in 0.5 m steps.</p>	

# TPE SERIES - THE NORTH AMERICAN STANDARD

Connection cables M12 - M12

– CMX-Outdoor

– Data

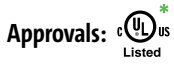

\* only for products with UL/CSA approved cable

Male

90°  
ITC, PLTC cable

Male

90°

Male

90°

Male

90°



## 1 Form

**4 4 5 6 1**

**4 4 5 6 1**

Type

4-pole, shielded

4-pole, shielded

Circuit diagram

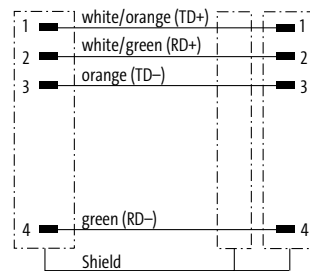
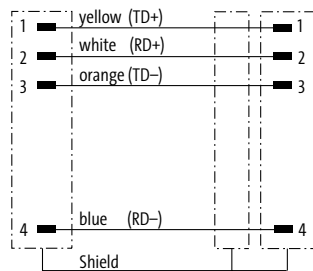

Contact layout

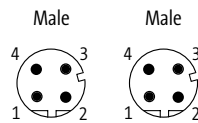

## 2 Cable Type

Jacket Color

Jacket Color

2x2x0.34 mm<sup>2</sup>  
TPE (UL/CSA), robots/C-tracks

green  
S7V

blue

2x2x0.25 mm<sup>2</sup>  
TPE (UL/CSA), robots/C-tracks

S4U

## 3 Cable Length

1.5 m	<b>0150</b>
3.0 m	<b>0300</b>
5.0 m	<b>0500</b>
7.5 m	<b>0750</b>
10.0 m	<b>1000</b>

## Technical Data

Operating voltage	max. 60 V DC
Protection	IP65, IP66K, IP67 inserted and tightened (EN 60529)
Temperature range	-25...+85 °C, depending on cable quality

## Article No.

The composition of your article number is explained on page 3.1.i

**7 7 0 0** - - - - -

**1** Form

**2** Cable Type

**3** Cable Length

Notes

Other versions on request. Differing cable lengths up to 2 m can be ordered in 0.2 m steps, from 2 m on in 0.5 m steps.

# TPE SERIES - THE NORTH AMERICAN STANDARD

## Connection cables M12 - M12

– CMX-Outdoor

– Data

**PROFI**® EtherNet/IP™  
**NET**

Approvals:  <sup>\*</sup>  
Listed

\* only for products with UL/CSA approved cable

**Male**  
straight  
ITC, PLTC cable

**Female**  
straight

**Male**  
straight

**Female**  
straight

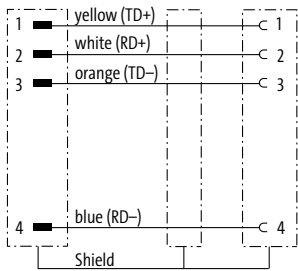
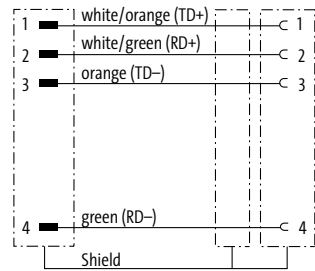
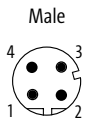
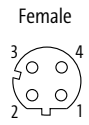

1 Form		4 4 5 7 1		4 4 5 7 1	
Type	4-pole, shielded D-coded			4-pole, shielded D-coded	
Circuit diagram					
Contact layout	 				
2 Cable Type		Jacket Color		Jacket Color	
2x2x0.34 mm <sup>2</sup> TPE (UL/CSA), robots/C-tracks		green S7V		blue	
2x2x0.25 mm <sup>2</sup> TPE (UL/CSA), robots/C-tracks				S4U	
3 Cable Length					
1.5 m		0150			
3.0 m		0300			
5.0 m		0500			
7.5 m		0750			
10.0 m		1000			
Technical Data					
Operating voltage		max. 60 V DC			
Protection		IP65, IP66K, IP67 inserted and tightened (EN 60529)			
Temperature range		-25...+85 °C, depending on cable quality			
Article No.					
The composition of your article number is explained on page 3.1.i		7 7 0 0 - - - - -		- - - - -	
		1 Form		2 Cable Type	
				3 Cable Length	
Notes		Other versions on request. Differing cable lengths up to 2 m can be ordered in 0.2 m steps, from 2 m on in 0.5 m steps.			

# TPE SERIES - THE NORTH AMERICAN STANDARD

Connection cables M12 - M12

– CMX-Outdoor

– Data



\* only for products with UL/CSA approved cable

**Male**

straight  
ITC, PLTC cable

**Flange female**

**Male**

straight

**Flange female**



1 Form		4 4 8 1 1		4 4 8 1 1	
Type	4-pole, shielded	D-coded		Rear mounting	
Circuit diagram					
Contact layout					
2 Cable Type		Jacket Color		Jacket Color	
2x2x0.34 mm <sup>2</sup>	TPE (UL/CSA), robots/C-tracks	green	S7V	blue	
2x2x0.25 mm <sup>2</sup>	TPE (UL/CSA), robots/C-tracks			S4U	
3 Cable Length					
1.5 m	0150				
3.0 m	0300				
5.0 m	0500				
7.5 m	0750				
10.0 m	1000				
Technical Data					
Operating voltage	max. 60 V DC				
Protection	IP67 inserted and tightened (EN 60529)				
Temperature range	-25...+85 °C, depending on cable quality				
Article No.					
The composition of your article number is explained on page 3.1.i		7 7 0 0 - - - - -		- - - - -	
		1 Form		2 Cable Type	
				3 Cable Length	
Notes		Other versions on request. Differing cable lengths up to 2 m can be ordered in 0.2 m steps, from 2 m on in 0.5 m steps.			



# TPE SERIES - THE NORTH AMERICAN STANDARD

## Connection cables M12 - RJ45

– CMX-Outdoor

– Data

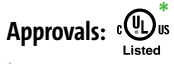

\* only for products with UL/CSA approved cable

**Male**  
straight  
ITC, PLTC cable

**Male**  
straight

**Male**  
straight

**Male**  
straight



1 Form		4 4 7 1 1		4 4 7 1 1	
Type	4-pole, shielded	D-coded		4-pole, shielded	
Circuit diagram					
Contact layout					
2 Cable Type		Jacket Color		Jacket Color	
2x2x0.34 mm <sup>2</sup> TPE (UL/CSA), robots/C-tracks		green		blue	
2x2x0.25 mm <sup>2</sup> TPE (UL/CSA), robots/C-tracks		S7V		S4U	
3 Cable Length					
1.5 m		0150			
3.0 m		0300			
5.0 m		0500			
7.5 m		0750			
10.0 m		1000			
Technical Data					
Operating voltage		max. 60 V DC			
Protection		IP67 (M12) - IP20 (RJ45)			
Temperature range		-25...+85 °C, depending on cable quality			
Article No.					
The composition of your article number is explained on page 3.1.i		<div style="display: flex; justify-content: space-around; align-items: center;"> <span style="border-bottom: 1px solid black; padding: 0 5px;">7</span> <span style="border-bottom: 1px solid black; padding: 0 5px;">7</span> <span style="border-bottom: 1px solid black; padding: 0 5px;">0</span> <span style="border-bottom: 1px solid black; padding: 0 5px;">0</span> <span style="font-size: 2em;">-</span> <span style="border-bottom: 1px solid black; padding: 0 5px;">-</span> <span style="font-size: 2em;">-</span> <span style="border-bottom: 1px solid black; padding: 0 5px;">-</span> <span style="border-bottom: 1px solid black; padding: 0 5px;">-</span> </div>			
		<b>1</b> Form		<b>2</b> Cable Type	
		<b>3</b> Cable Length			
Notes		Other versions on request. Differing cable lengths up to 2 m can be ordered in 0.2 m steps, from 2 m on in 0.5 m steps.			

# TPE SERIES - THE NORTH AMERICAN STANDARD

Connection cables M12 - RJ45

– CMX-Outdoor

– Data

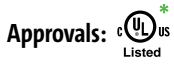

\* only for products with UL/CSA approved cable

**Male**

90°  
ITC, PLTC cable



**Male**

straight

**Male**

90°



**Male**

straight

1 Form		44761	44761
Type	4-pole, shielded D-coded	4-pole, shielded D-coded	4-pole, shielded D-coded
Circuit diagram			
Contact layout			
2 Cable Type		Jacket Color	
2x2x0.34 mm <sup>2</sup> TPE (UL/CSA), robots/C-tracks		green	blue
2x2x0.25 mm <sup>2</sup> TPE (UL/CSA), robots/C-tracks		S7V	S4U
3 Cable Length			
1.5 m		0150	
3.0 m		0300	
5.0 m		0500	
7.5 m		0750	
10.0 m		1000	
Technical Data			
Operating voltage		max. 60 V DC	
Protection		IP67 (M12) - IP20 (RJ45)	
Temperature range		-25...+85 °C, depending on cable quality	
Article No.			
The composition of your article number is explained on page 3.1.i		<div style="display: flex; justify-content: space-around; align-items: center;"> <span style="border-bottom: 1px solid black; padding: 0 5px;">7</span> <span style="border-bottom: 1px solid black; padding: 0 5px;">7</span> <span style="border-bottom: 1px solid black; padding: 0 5px;">0</span> <span style="border-bottom: 1px solid black; padding: 0 5px;">0</span> <span style="font-size: 2em;">-</span> <span style="border-bottom: 1px solid black; padding: 0 5px;"> </span> <span style="font-size: 2em;">-</span> <span style="border-bottom: 1px solid black; padding: 0 5px;"> </span> <span style="border-bottom: 1px solid black; padding: 0 5px;"> </span> </div>	
		<b>1</b>	<b>2</b>
		Form	Cable Type
		<b>3</b>	Cable Length
Notes		Other versions on request. Differing cable lengths up to 2 m can be ordered in 0.2 m steps, from 2 m on in 0.5 m steps.	

# TPE SERIES - THE NORTH AMERICAN STANDARD

## Connection cables M12 - RJ45

– CMX-Outdoor

– Data

**PROFI**® EtherNet/IP™  
**NET**

Approvals:  <sup>\*</sup>  
Listed

\* only for products with UL/CSA approved cable

### Flange female

ITC, PLTC cable

### Male

straight



### Flange female

### Male

straight



## 1 Form

### 4 4 8 5 1

### 4 4 8 5 1

#### Type

4-pole, shielded

4-pole, shielded

#### Circuit diagram

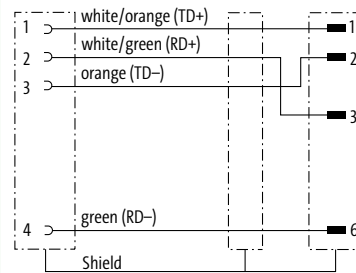
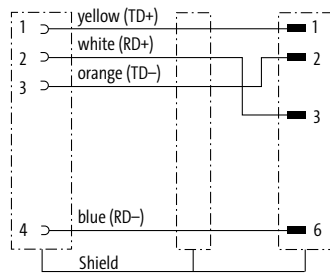

#### Contact layout

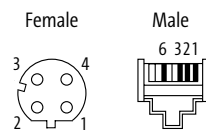

## 2 Cable Type

### Jacket Color

### Jacket Color

2x2x0.34 mm<sup>2</sup>  
TPE (UL/CSA), robots/C-tracks

green  
S7V

blue

2x2x0.25 mm<sup>2</sup>  
TPE (UL/CSA), robots/C-tracks

S4U

## 3 Cable Length

1.5 m	0150
3.0 m	0300
5.0 m	0500
7.5 m	0750
10.0 m	1000

### Technical Data

Operating voltage	max. 60 V DC
Protection	IP67 (M12) - IP20 (RJ45)
Temperature range	-25...+85 °C, depending on cable quality

### Article No.

The composition of your article number is explained on page 3.1.i

7 7 0 0 - - - - -

**1** Form

**2** Cable Type

**3** Cable Length

#### Notes

Other versions on request. Differing cable lengths up to 2 m can be ordered in 0.2 m steps, from 2 m on in 0.5 m steps.

# TPE SERIES - THE NORTH AMERICAN STANDARD

Connection cables RJ45 - RJ45

– CMX-Outdoor

– Data

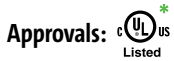

\* only for products with UL/CSA approved cable

**Male**

straight  
ITC, PLTC cable

**Male**

straight

**Male**

straight

**Male**

straight



## 1 Form

**74301**

**74301**

Type

4-pole, shielded

4-pole, shielded

Circuit diagram

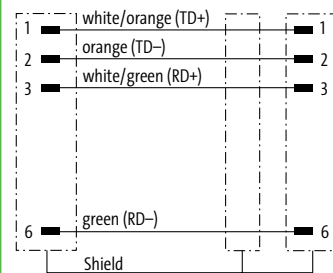
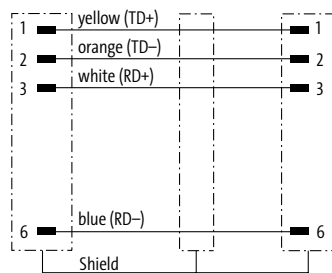

Contact layout

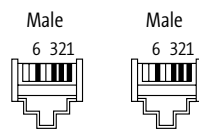

## 2 Cable Type

Jacket Color

Jacket Color

2x2x0.34 mm<sup>2</sup>  
TPE (UL/CSA), robots/C-tracks

green  
S7V

blue

2x2x0.25 mm<sup>2</sup>  
TPE (UL/CSA), robots/C-tracks

S4U

## 3 Cable Length

1.5 m	0150
3.0 m	0300
5.0 m	0500
7.5 m	0750
10.0 m	1000

## Technical Data

Operating voltage	max. 60 V DC
Protection	IP20 inserted and tightened (EN 60529)
Temperature range	-25...+85 °C, depending on cable quality

## Article No.

The composition of your article number is explained on page 3.1.i

**7 7 0 0** - - - - -

**1** Form

**2** Cable Type

**3** Cable Length

Notes

Other versions on request. Differing cable lengths up to 2 m can be ordered in 0.2 m steps, from 2 m on in 0.5 m steps.

# TPE SERIES - THE NORTH AMERICAN STANDARD

Connection cables M12 - M12

– CMX-Outdoor

– Data

**PROFI**® EtherNet/IP™  
**NET**

Male  
straight

Male  
straight

Male  
straight

Male  
90°



## 1 Form

**48511**

**48541**

Type  
Circuit diagram

8-pole, shielded

8-pole, shielded

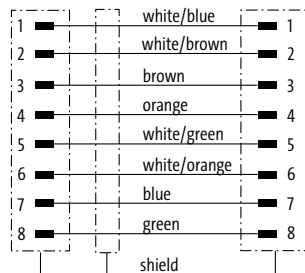

Contact layout

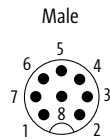

## 2 Cable Type

Jacket Color

Jacket Color

4x2x0.25 mm<sup>2</sup>  
TPE (UL/CSA), robots/C-tracks

blue  
S4W

blue  
S4W

## 3 Cable Length

1.5 m	<b>0150</b>
3.0 m	<b>0300</b>
5.0 m	<b>0500</b>
7.5 m	<b>0750</b>
10.0 m	<b>1000</b>

## Technical Data

Operating voltage	max. 60 V AC/DC
Protection	IP65 and IP67 when plugged and screwed down (EN 60529)
Temperature range	-25...+85 °C, depending on cable quality

## Article No.

The composition of your article number is explained on page 3.1.i

**7 7 0 0** - - - - -

**1** Form

**2** Cable Type

**3** Cable Length

Notes

Other versions on request. Differing cable lengths up to 2 m can be ordered in 0.2 m steps, from 2 m on in 0.5 m steps.

# TPE SERIES - THE NORTH AMERICAN STANDARD

Connection cables M12 - M12

– CMX-Outdoor

– Data

**PROFI**® EtherNet/IP™  
**NET**

Male  
90°

Male  
90°



## 1 Form 48561

Type **8-pole, shielded**

Circuit diagram

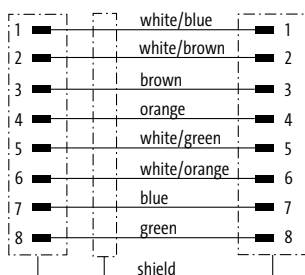

Contact layout

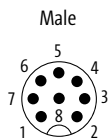

## 2 Cable Type Jacket Color

4x2x0.25 mm<sup>2</sup>

TPE (UL/CSA), robots/C-tracks

blue

S4W

## 3 Cable Length

1.5 m

0150

3.0 m

0300

5.0 m

0500

7.5 m

0750

10.0 m

1000

### Technical Data

Operating voltage

max. 60 V AC/DC

Protection

IP65 and IP67 when plugged and screwed down (EN 60529)

Temperature range

-25...+85 °C, depending on cable quality

### Article No.

The composition of your article number is explained on page 3.1.i

7 7 0 0

-

4 8 5 6 1

-

\_\_\_\_

\_\_\_\_

**1** Form

**2** Cable Type

**3** Cable Length

Notes

Other versions on request. Differing cable lengths up to 2 m can be ordered in 0.2 m steps, from 2 m on in 0.5 m steps.

# TPE SERIES - THE NORTH AMERICAN STANDARD

Connection cables M12 - M12

– CMX-Outdoor

– Data

**PROFI**® EtherNet/IP™  
**NET**

**Male**

straight

**Female**

straight



## 1 Form

**48571**

Type

8-pole, shielded

Circuit diagram

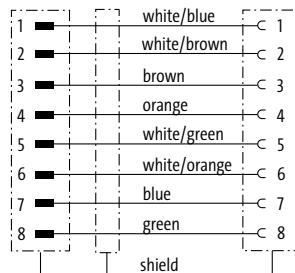

Contact layout

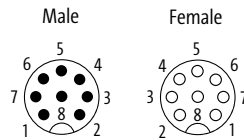

## 2 Cable Type

Jacket Color

4x2x0.25 mm<sup>2</sup>  
TPE (UL/CSA), robots/C-tracks

blue  
S4W

## 3 Cable Length

1.5 m	<b>0150</b>
3.0 m	<b>0300</b>
5.0 m	<b>0500</b>
7.5 m	<b>0750</b>
10.0 m	<b>1000</b>

## Technical Data

Operating voltage	max. 60 V AC/DC
Protection	IP65 and IP67 when plugged and screwed down (EN 60529)
Temperature range	-25...+85 °C, depending on cable quality

## Article No.

The composition of your article number is explained on page 3.1.i

7 7 0 0

-

4 8 5 7 1

-

\_\_\_\_

\_\_\_\_

**1**

Form

**2**

Cable Type

**3**

Cable Length

Notes

Other versions on request. Differing cable lengths up to 2 m can be ordered in 0.2 m steps, from 2 m on in 0.5 m steps.

# TPE SERIES - THE NORTH AMERICAN STANDARD

Connection cables M12 - M12

– CMX-Outdoor

– Data

**PROFI** EtherNet/IP  
**NET**

**Male**  
straight

**Male**  
straight

**Male**  
90°

**Male**  
straight



<b>1 Form</b>	<b>48521</b>	<b>48551</b>
---------------	--------------	--------------

Type	8-pole, shielded	8-pole, shielded
------	------------------	------------------

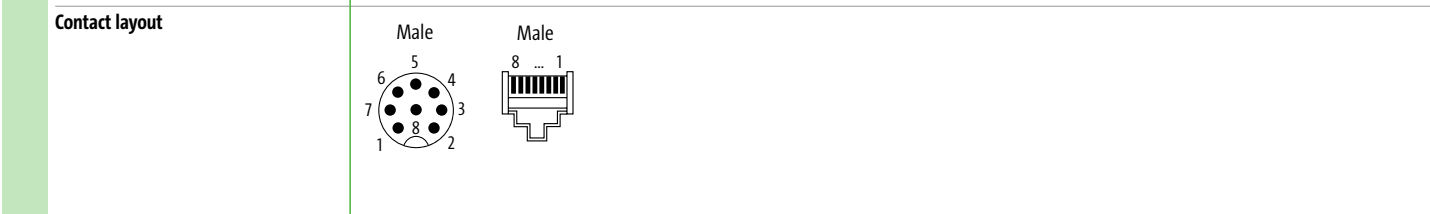
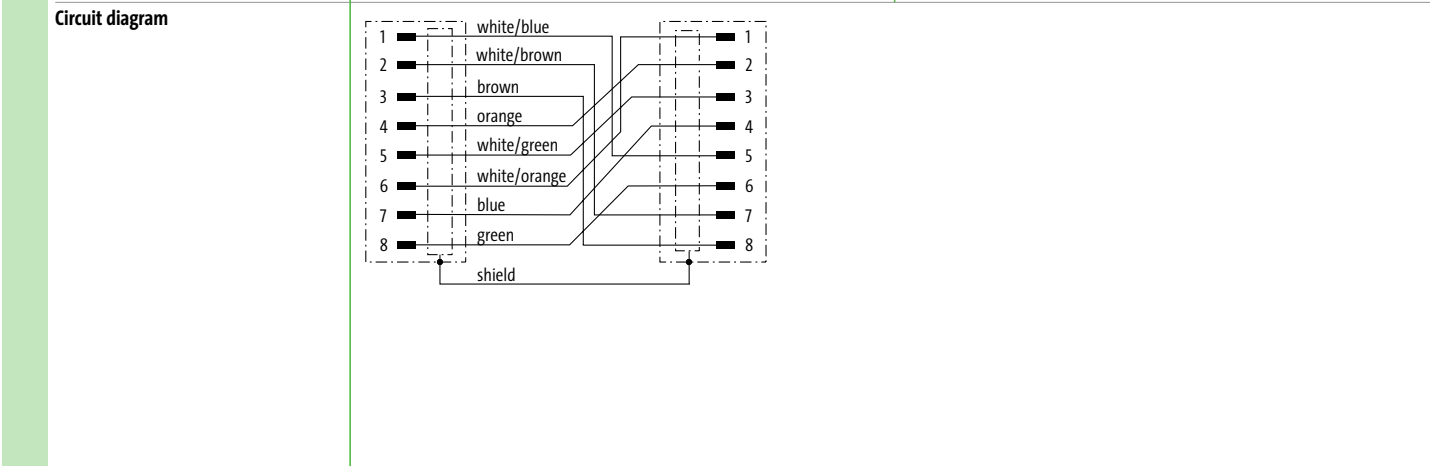

<b>2 Cable Type</b>	<b>Jacket Color</b>	<b>Jacket Color</b>
---------------------	---------------------	---------------------

4x2x0.25 mm <sup>2</sup> TPE (UL/CSA), robots/C-tracks	blue S4W	blue S4W
---	-------------	-------------

<b>3 Cable Length</b>	
-----------------------	--

1.5 m	<b>0150</b>
3.0 m	<b>0300</b>
5.0 m	<b>0500</b>
7.5 m	<b>0750</b>
10.0 m	<b>1000</b>

<b>Technical Data</b>	
-----------------------	--

Operating voltage	max. 30 V AC/DC
Protection	IP67 (M12) - IP20 (RJ45)
Temperature range	-25...+85 °C, depending on cable quality

<b>Article No.</b>	
--------------------	--

The composition of your article number is explained on page 3.1.i

<b>7</b>	<b>7</b>	<b>0</b>	<b>0</b>	-	-	-	-
----------	----------	----------	----------	---	---	---	---

<b>1 Form</b>	<b>2 Cable Type</b>	<b>3 Cable Length</b>
---------------	---------------------	-----------------------

Notes

Other versions on request. Differing cable lengths up to 2 m can be ordered in 0.2 m steps, from 2 m on in 0.5 m steps.



# TPE SERIES - THE NORTH AMERICAN STANDARD

Connection cables M12 - M12

– CMX-Outdoor

– Data

**PROFI**® EtherNet/IP™  
**NET**

Flange female

Male  
straight



<b>1 Form</b>	<b>48851</b>	
Type	8-pole, shielded Rear mounting	
Circuit diagram		
Contact layout		
<b>2 Cable Type</b>	<b>Jacket Color</b>	
4x2x0.25 mm <sup>2</sup> TPE (UL/CSA), robots/C-tracks	blue S4W	
<b>3 Cable Length</b>		
1.5 m	<b>0150</b>	
3.0 m	<b>0300</b>	
5.0 m	<b>0500</b>	
7.5 m	<b>0750</b>	
10.0 m	<b>1000</b>	
<b>Technical Data</b>		
Operating voltage	max. 30 V AC/DC	
Protection	IP67 (M12) - IP20 (RJ45)	
Temperature range	-25...+85 °C, depending on cable quality	
<b>Article No.</b>		
The composition of your article number is explained on page 3.1.i	<div style="display: flex; justify-content: space-around; align-items: center;"> <span><u>7</u> <u>7</u> <u>0</u> <u>0</u></span> <span>-</span> <span><u>4</u> <u>8</u> <u>8</u> <u>5</u> <u>1</u></span> <span>-</span> <span>  </span> <span>  </span> <span>  </span> </div>	
	<b>1</b> Form	<b>2</b> Cable Type
		<b>3</b> Cable Length
<b>Notes</b>	Other versions on request. Differing cable lengths up to 2 m can be ordered in 0.2 m steps, from 2 m on in 0.5 m steps.	

TPE Series - The North American standard

# TPE SERIES - THE NORTH AMERICAN STANDARD

Connection cables RJ45 - RJ45

– CMX-Outdoor

– Data



Male  
straight

Male  
straight



## 1 Form 74718

Type 8-pole, shielded

Circuit diagram	
1	white/orange
2	orange
3	white/green
4	green
5	white/brown
6	brown
7	white/blue
8	blue
shield	

Contact layout	
Male	

## 2 Cable Type Jacket Color

4x2x0.25 mm <sup>2</sup>	blue
TPE (UL/CSA), robots/Ctracks	S4W

## 3 Cable Length

1.5 m	<b>0150</b>
3.0 m	<b>0300</b>
5.0 m	<b>0500</b>
7.5 m	<b>0750</b>
10.0 m	<b>1000</b>

## Technical Data

Operating voltage	max. 60 V DC
Protection	IP20 inserted and tightened (EN 60529)
Temperature range	-25...+85 °C, depending on cable quality

## Article No.

The composition of your article number is explained on page 3.1.i	<u>7</u> <u>7</u> <u>0</u> <u>0</u> - <u>7</u> <u>4</u> <u>7</u> <u>1</u> <u>8</u> - _ _ _ _
	<b>1</b> Form <b>2</b> Cable Type <b>3</b> Cable Length

## Notes

Other versions on request. Differing cable lengths up to 2 m can be ordered in 0.2 m steps, from 2 m on in 0.5 m steps.

# TPE SERIES - THE NORTH AMERICAN STANDARD

## Connection cables M12 - M12

– CMX-Outdoor

– Data

– X-coded



\* only for products with UL/CSA approved cable

Male  
straight

Male  
straight

Male  
straight

Male  
90°



<b>1 Form</b>	<b>510 01</b>	<b>51011</b>
Approvals	cULus *	
Type	8-pole, shielded X-coded	8-pole, shielded X-coded

### Circuit diagram

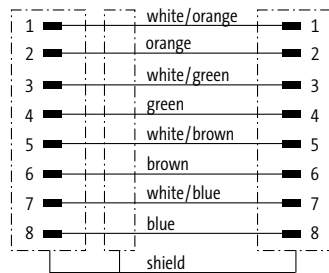

### Contact layout

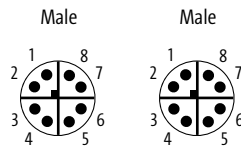

<b>2 Cable Type</b>	<b>Jacket Color</b>	<b>Jacket Color</b>
4x2x0.14 mm <sup>2</sup> TPE (UL/CSA), robots/C-tracks	blue S4X	blue S4X

<b>3 Cable Length</b>	
1.5 m	0150
3.0 m	0300
5.0 m	0500
7.5 m	0750
10.0 m	1000

### Technical Data

Operating voltage	max. 50 V AC/60 V DC
Protection	IP67 inserted and tightened (EN 60529)
Temperature range	-25...+85 °C, depending on cable quality

### Article No.

The composition of your article number is explained on page 3.1.i

7 7 0 0 - - - - -

**1** Form      **2** Cable Type      **3** Cable Length

### Notes

Other versions on request. Differing cable lengths up to 2 m can be ordered in 0.2 m steps, from 2 m on in 0.5 m steps.

# TPE SERIES - THE NORTH AMERICAN STANDARD

Connection cables M12 - M12

- CMX-Outdoor
- Data
- X-coded

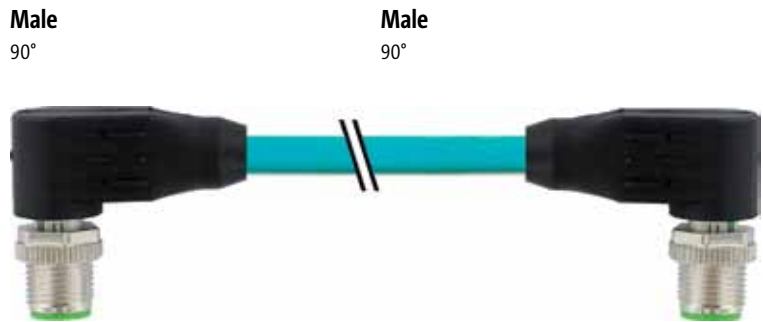

<b>1 Form</b>	<b>51021</b>	
Type	8-pole, shielded X-coded	
Circuit diagram		
Contact layout		
<b>2 Cable Type</b>	<b>Jacket Color</b>	
4x2x0.14 mm <sup>2</sup> TPE (UL/CSA), robots/Ctracks	blue S4X	
<b>3 Cable Length</b>		
1.5 m	<b>0150</b>	
3.0 m	<b>0300</b>	
5.0 m	<b>0500</b>	
7.5 m	<b>0750</b>	
10.0 m	<b>1000</b>	
<b>Technical Data</b>		
Operating voltage	max. 50 V AC/60 V DC	
Protection	IP67 inserted and tightened (EN 60529)	
Temperature range	-25...+85 °C, depending on cable quality	
<b>Article No.</b>		
The composition of your article number is explained on page 3.1.i	<div style="display: flex; justify-content: space-around; align-items: center;"> <span><u>7</u> <u>7</u> <u>0</u> <u>0</u></span> <span>-</span> <span><u>5</u> <u>1</u> <u>0</u> <u>2</u> <u>1</u></span> <span>-</span> <span>    </span> <span>    </span> </div>	
	<b>1 Form</b>	<b>2 Cable Type</b>
		<b>3 Cable Length</b>
<b>Notes</b>	Other versions on request. Differing cable lengths up to 2 m can be ordered in 0.2 m steps, from 2 m on in 0.5 m steps.	

# TPE SERIES - THE NORTH AMERICAN STANDARD

## Connection cables M12 - RJ45

– CMX-Outdoor

– Data

– X-coded



Male  
straight

Male  
straight

Male  
90°

Male  
straight



<b>1 Form</b>	<b>51101</b>	<b>51201</b>	
	8-pole, shielded	8-pole, shielded	
Type			
Circuit diagram			
Contact layout			
<b>2 Cable Type</b>	<b>Jacket Color</b>	<b>Jacket Color</b>	
4x2x0.14 mm <sup>2</sup> TPE (UL/CSA), robots/C-tracks	blue S4X	blue S4X	
<b>3 Cable Length</b>			
1.5 m	0150		
3.0 m	0300		
5.0 m	0500		
7.5 m	0750		
10.0 m	1000		
<b>Technical Data</b>			
Operating voltage	max. 60 V DC		
Protection	IP66K, IP67 (M12) - IP20 (RJ45)		
Temperature range	-25...+85 °C, depending on cable quality		
<b>Article No.</b>			
The composition of your article number is explained on page 3.1.i	<div style="display: flex; justify-content: space-around; align-items: center;"> <span style="border-bottom: 1px solid black; padding: 0 5px;">7</span> <span style="border-bottom: 1px solid black; padding: 0 5px;">7</span> <span style="border-bottom: 1px solid black; padding: 0 5px;">0</span> <span style="border-bottom: 1px solid black; padding: 0 5px;">0</span> <span style="font-size: 1.5em;">-</span> <span style="border-bottom: 1px solid black; padding: 0 5px;"> </span> <span style="font-size: 1.5em;">-</span> <span style="border-bottom: 1px solid black; padding: 0 5px;"> </span> <span style="border-bottom: 1px solid black; padding: 0 5px;"> </span> <span style="border-bottom: 1px solid black; padding: 0 5px;"> </span> </div>		
	<b>1 Form</b>	<b>2 Cable Type</b>	<b>3 Cable Length</b>
<b>Notes</b>	Other versions on request. Differing cable lengths up to 2 m can be ordered in 0.2 m steps, from 2 m on in 0.5 m steps.		

TPE Series - The North American standard

# TPE SERIES - THE NORTH AMERICAN STANDARD

Connection cables RJ45 - RJ45

– CMX-Outdoor

– Data

– X-coded

**PROFI**® EtherNet/IP™  
**NET**

Male  
straight

Male  
straight

Male  
straight

Flange female



<b>1 Form</b>	<b>74315</b>	<b>51551</b>
	Type 8-pole, shielded	Type 8-pole, shielded Rear mounting
Circuit diagram		
Contact layout	<p>Male</p>	<p>Male</p> <p>Female</p>
<b>2 Cable Type</b>	<b>Jacket Color</b>	<b>Jacket Color</b>
4x2x0.14 mm <sup>2</sup> TPE (UL/CSA), robots/Ctracks	blue S4X	blue S4X
<b>3 Cable Length</b>		
1.5 m	0150	
3.0 m	0300	
5.0 m	0500	
7.5 m	0750	
10.0 m	1000	
<b>Technical Data</b>		
Operating voltage	max. 60 V DC	
Protection	IP20 inserted and tightened (EN 60529)	IP67 (M12) - IP20 (RJ45)
Temperature range	-25...+85 °C, depending on cable quality	
<b>Article No.</b>		
The composition of your article number is explained on page 3.1.i	<b>7 7 0 0</b> - - - - -	- - - - -
	<b>1 Form</b>	<b>2 Cable Type</b> <b>3 Cable Length</b>
<b>Notes</b>	Other versions on request. Differing cable lengths up to 2 m can be ordered in 0.2 m steps, from 2 m on in 0.5 m steps.	

# TPE SERIES - THE NORTH AMERICAN STANDARD

With open ended wires

- 7/8" MINI

- Power

Approvals: 

\* only for products with UL/CSA approved cable

Male



straight  
TC-ER



Male

straight

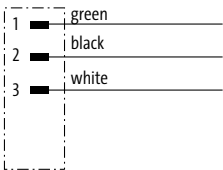

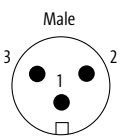
<b>1 Form</b>	<b>A 3001</b>	<b>A 3001</b>				
	<b>3-pole</b>	<b>3-pole</b>				
<b>Type</b>	<b>3-pole</b>	<b>3-pole</b>				
<b>Circuit diagram</b>						
<b>Contact layout</b>						
<b>2 Cable Type</b>	<b>Jacket Color</b>	<b>Jacket Color</b>				
Wire diameter 1.5 mm <sup>2</sup> PUR (UL/CSA), C-tracks TPE (UL/CSA), robots	<table border="1"> <tr><td>yellow</td></tr> <tr><td>U1B</td></tr> </table>	yellow	U1B	<table border="1"> <tr><td>black</td></tr> <tr><td>UMB</td></tr> </table>	black	UMB
yellow						
U1B						
black						
UMB						
<b>3 Cable Length</b>						
1.5 m	<b>0150</b>					
3.0 m	<b>0300</b>					
5.0 m	<b>0500</b>					
7.5 m	<b>0750</b>					
10.0 m	<b>1000</b>					
<b>Technical Data</b>						
Operating voltage	max. 600 V AC/DC					
Protection	IP68 inserted and tightened (EN 60529)					
Temperature range	-25...+80 °C, depending on cable quality					
<b>Article No.</b>						
The composition of your article number is explained on page 3.1.i	<table border="1"> <tr> <td><u>7</u> <u>7</u> <u>0</u> <u>0</u></td> <td>-</td> <td>-</td> <td>-</td> </tr> </table>		<u>7</u> <u>7</u> <u>0</u> <u>0</u>	-	-	-
<u>7</u> <u>7</u> <u>0</u> <u>0</u>	-	-	-			
	<b>1 Form</b>	<b>2 Cable Type</b>	<b>3 Cable Length</b>			
<b>Notes</b>	Other versions on request. Differing cable lengths up to 2 m can be ordered in 0.2 m steps, from 2 m on in 0.5 m steps.					

# TPE SERIES - THE NORTH AMERICAN STANDARD

With open ended wires

- 7/8" MINI

- Power

**Male**

straight  
TC-ER



**Male**

straight



Approvals: \*

\* only for products with UL/CSA approved cable

1 Form		A 4 0 0 1	A 4 0 0 1
Type		4-pole	4-pole
Circuit diagram			
Contact layout			
2 Cable Type		Jacket Color	Jacket Color
Wire diameter 1.5 mm <sup>2</sup> PUR (UL/CSA), C-tracks TPE (UL/CSA), robots		<div style="background-color: yellow; padding: 2px;">yellow</div> <div style="background-color: yellow; padding: 2px;">U1C</div>	<div style="background-color: black; color: white; padding: 2px;">black</div> <div style="background-color: black; color: white; padding: 2px;">UMC</div>
3 Cable Length			
1.5 m		0150	
3.0 m		0300	
5.0 m		0500	
7.5 m		0750	
10.0 m		1000	
Technical Data			
Operating voltage		max. 600 V AC/DC	
Protection		IP68 inserted and tightened (EN 60529)	
Temperature range		-25...+80 °C, depending on cable quality	
Article No.			
The composition of your article number is explained on page 3.1.i		<div style="border-bottom: 1px solid black; width: 20px; display: inline-block; margin-right: 5px;">7</div> <div style="border-bottom: 1px solid black; width: 20px; display: inline-block; margin-right: 5px;">7</div> <div style="border-bottom: 1px solid black; width: 20px; display: inline-block; margin-right: 5px;">0</div> <div style="border-bottom: 1px solid black; width: 20px; display: inline-block; margin-right: 5px;">0</div> <span style="font-size: 1.2em;">-</span> <span style="border-bottom: 1px dashed black; width: 40px; display: inline-block; margin-right: 5px;"></span> <span style="font-size: 1.2em;">-</span> <span style="border-bottom: 1px dashed black; width: 40px; display: inline-block; margin-right: 5px;"></span> <span style="font-size: 1.2em;">-</span> <span style="border-bottom: 1px dashed black; width: 40px; display: inline-block; margin-right: 5px;"></span>	<div style="border-bottom: 1px dashed black; width: 40px; display: inline-block; margin-right: 5px;"></div> <span style="font-size: 1.2em;">-</span> <div style="border-bottom: 1px dashed black; width: 40px; display: inline-block; margin-right: 5px;"></div> <span style="font-size: 1.2em;">-</span> <div style="border-bottom: 1px dashed black; width: 40px; display: inline-block; margin-right: 5px;"></div>
		<b>1</b> Form	<b>2</b> Cable Type
			<b>3</b> Cable Length
Notes		Other versions on request. Differing cable lengths up to 2 m can be ordered in 0.2 m steps, from 2 m on in 0.5 m steps.	



# TPE SERIES - THE NORTH AMERICAN STANDARD

With open ended wires

- 7/8" MINI

- Power

Approvals: 

\* only for products with UL/CSA approved cable

Male

straight  
TC-ER



Male

straight

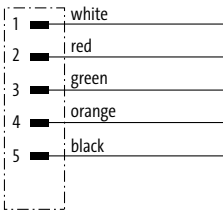
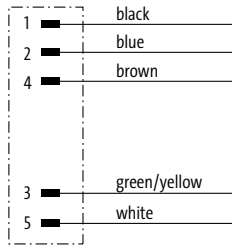
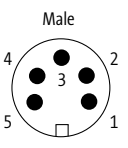

<b>1 Form</b>	<b>A 5001</b>	<b>A 5001</b>
	5-pole	5-pole
<b>Type</b>	5-pole	5-pole
<b>Circuit diagram</b>		
<b>Contact layout</b>		
<b>2 Cable Type</b>	<b>Jacket Color</b>	<b>Jacket Color</b>
Wire diameter 1.5 mm <sup>2</sup> PUR (UL/CSA), C-tracks TPE (UL/CSA), robots	yellow U1D	black UMD
<b>3 Cable Length</b>		
1.5 m	0150	
3.0 m	0300	
5.0 m	0500	
7.5 m	0750	
10.0 m	1000	
<b>Technical Data</b>		
Operating voltage	max. 600 V AC/DC	
Protection	IP68 inserted and tightened (EN 60529)	
Temperature range	-25...+80 °C, depending on cable quality	
<b>Article No.</b>		
The composition of your article number is explained on page 3.1.i	<div style="display: flex; justify-content: space-around; align-items: center;"> <span style="border-bottom: 1px solid black; padding: 0 5px;">7</span> <span style="border-bottom: 1px solid black; padding: 0 5px;">7</span> <span style="border-bottom: 1px solid black; padding: 0 5px;">0</span> <span style="border-bottom: 1px solid black; padding: 0 5px;">0</span> <span style="font-size: 2em;">-</span> <span style="border-bottom: 1px solid black; padding: 0 5px;"> </span> <span style="font-size: 2em;">-</span> <span style="border-bottom: 1px solid black; padding: 0 5px;"> </span> <span style="border-bottom: 1px solid black; padding: 0 5px;"> </span> </div>	
	<b>1 Form</b>	<b>2 Cable Type</b>
		<b>3 Cable Length</b>
<b>Notes</b>	Other versions on request. Differing cable lengths up to 2 m can be ordered in 0.2 m steps, from 2 m on in 0.5 m steps.	

TPE Series - The North American standard

# TPE SERIES - THE NORTH AMERICAN STANDARD

With open ended wires

- 7/8" MINI

- Power



\* only for products with UL/CSA approved cable

**Male**

90°  
TC-ER



**Male**

90°



1 Form		A3011	A3011
Type		3-pole	3-pole
Circuit diagram			
Contact layout			
2 Cable Type		Jacket Color	Jacket Color
Wire diameter 1.5 mm <sup>2</sup>		yellow	black
PUR (UL/CSA), C-tracks			UMB
TPE (UL/CSA), robots		U1B	
3 Cable Length			
1.5 m		0150	
3.0 m		0300	
5.0 m		0500	
7.5 m		0750	
10.0 m		1000	
Technical Data			
Operating voltage		max. 600 V AC/DC	
Protection		IP68 inserted and tightened (EN 60529)	
Temperature range		-25...+80 °C, depending on cable quality	
Article No.			
The composition of your article number is explained on page 3.1.i		7 7 0 0 - - - - -	- - - - -
		<b>1</b> Form	<b>2</b> Cable Type <b>3</b> Cable Length
Notes			
		Other versions on request. Differing cable lengths up to 2 m can be ordered in 0.2 m steps, from 2 m on in 0.5 m steps.	

# TPE SERIES - THE NORTH AMERICAN STANDARD

With open ended wires

- 7/8" MINI

- Power

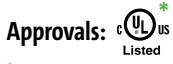

\* only for products with UL/CSA approved cable

Male

90°  
TC-ER



Male

90°



<b>1 Form</b>	<b>Form</b>	<b>A 4 0 1 1</b>		<b>A 4 0 1 1</b>								
	Type	4-pole		4-pole								
	Circuit diagram											
<b>2 Cable Type</b>	Contact layout											
	Jacket Color	<table border="1"> <tr><td>yellow</td></tr> <tr><td>U1C</td></tr> </table>		yellow	U1C	<table border="1"> <tr><td>black</td></tr> <tr><td>UMC</td></tr> </table>		black	UMC			
yellow												
U1C												
black												
UMC												
<b>3 Cable Length</b>	Wire diameter 1.5 mm <sup>2</sup>	PUR (UL/CSA), C-tracks		black								
		TPE (UL/CSA), robots		UMC								
	1.5 m	0150										
	3.0 m	0300										
	5.0 m	0500										
<b>Technical Data</b>	7.5 m	0750										
	10.0 m	1000										
	Operating voltage	max. 600 V AC/DC										
	Protection	IP68 inserted and tightened (EN 60529)										
	Temperature range	-25...+80 °C, depending on cable quality										
<b>Article No.</b>	Article No.											
	The composition of your article number is explained on page 3.1.i	<table border="1"> <tr> <td><u>7</u></td> <td><u>7</u></td> <td><u>0</u></td> <td><u>0</u></td> <td>-</td> <td>-</td> <td>-</td> <td>-</td> </tr> </table>				<u>7</u>	<u>7</u>	<u>0</u>	<u>0</u>	-	-	-
<u>7</u>	<u>7</u>	<u>0</u>	<u>0</u>	-	-	-	-					
<b>Notes</b>		<b>1</b> Form	<b>2</b> Cable Type	<b>3</b> Cable Length								
	Notes	Other versions on request. Differing cable lengths up to 2 m can be ordered in 0.2 m steps, from 2 m on in 0.5 m steps.										

# TPE SERIES - THE NORTH AMERICAN STANDARD

With open ended wires

- 7/8" MINI

- Power

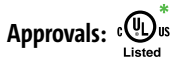

\* only for products with UL/CSA approved cable

Male

90°  
TC-ER



Male

90°



1 Form		A5011	A5011
Type	5-pole	5-pole	5-pole
Circuit diagram			
Contact layout			
2 Cable Type	Jacket Color	Jacket Color	Jacket Color
Wire diameter 1.5 mm <sup>2</sup> PUR (UL/CSA), C-tracks TPE (UL/CSA), robots	yellow UID		black UMD
3 Cable Length			
1.5 m	0150		
3.0 m	0300		
5.0 m	0500		
7.5 m	0750		
10.0 m	1000		
Technical Data			
Operating voltage	max. 600 V AC/DC		
Protection	IP68 inserted and tightened (EN 60529)		
Temperature range	-25...+80 °C, depending on cable quality		
Article No.			
The composition of your article number is explained on page 3.1.i	<u>7 7 0 0</u> - - - - -	- - - - -	- - - - -
	<b>1</b> Form	<b>2</b> Cable Type	<b>3</b> Cable Length
Notes	Other versions on request. Differing cable lengths up to 2 m can be ordered in 0.2 m steps, from 2 m on in 0.5 m steps.		

# TPE SERIES - THE NORTH AMERICAN STANDARD

With open ended wires

- 7/8" MINI

- Power

Approvals: 

\* only for products with UL/CSA approved cable

Female  
straight  
TC-ER



Female  
straight

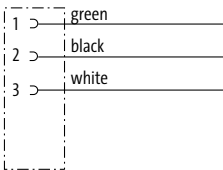
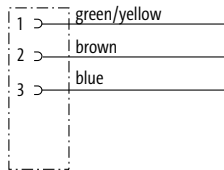
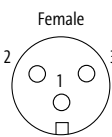

<b>1 Form</b>	<b>A 3 0 2 1</b>	<b>A 3 0 2 1</b>								
	Type 3-pole	Type 3-pole								
Circuit diagram										
Contact layout										
<b>2 Cable Type</b>	<b>Jacket Color</b>	<b>Jacket Color</b>								
Wire diameter 1.5 mm <sup>2</sup> PUR (UL/CSA), C-tracks TPE (UL/CSA), robots	<table border="1"> <tr><td>yellow</td></tr> <tr><td>U1B</td></tr> </table>	yellow	U1B	<table border="1"> <tr><td>black</td></tr> <tr><td>UMB</td></tr> </table>	black	UMB				
yellow										
U1B										
black										
UMB										
<b>3 Cable Length</b>										
1.5 m	0150									
3.0 m	0300									
5.0 m	0500									
7.5 m	0750									
10.0 m	1000									
<b>Technical Data</b>										
Operating voltage	max. 600 V AC/DC									
Protection	IP68 inserted and tightened (EN 60529)									
Temperature range	-25...+80 °C, depending on cable quality									
<b>Article No.</b>										
The composition of your article number is explained on page 3.1.i	<table border="1"> <tr> <td><u>7</u></td> <td><u>7</u></td> <td><u>0</u></td> <td><u>0</u></td> <td>-</td> <td>-</td> <td>-</td> <td>-</td> </tr> </table>		<u>7</u>	<u>7</u>	<u>0</u>	<u>0</u>	-	-	-	-
<u>7</u>	<u>7</u>	<u>0</u>	<u>0</u>	-	-	-	-			
	<b>1 Form</b>	<b>2 Cable Type</b>	<b>3 Cable Length</b>							
<b>Notes</b>	Other versions on request. Differing cable lengths up to 2 m can be ordered in 0.2 m steps, from 2 m on in 0.5 m steps.									

TPE Series - The North American standard

# TPE SERIES - THE NORTH AMERICAN STANDARD

With open ended wires

- 7/8" MINI

- Power

Female

straight  
TC-ER



Female

straight



Approvals:  \*

\* only for products with UL/CSA approved cable

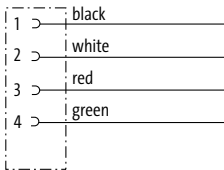
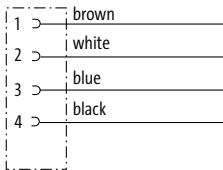
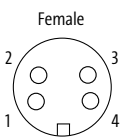
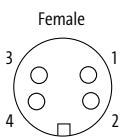
1 Form		A 4 0 2 1	A 4 0 2 1
Type		4-pole	4-pole
Circuit diagram			
Contact layout			
2 Cable Type		Jacket Color	Jacket Color
Wire diameter 1.5 mm <sup>2</sup> PUR (UL/CSA), C-tracks TPE (UL/CSA), robots		<div style="background-color: yellow; padding: 2px;">yellow</div> <div style="background-color: yellow; padding: 2px;">U1C</div>	<div style="background-color: black; color: white; padding: 2px;">black</div> <div style="background-color: black; color: white; padding: 2px;">UMC</div>
3 Cable Length			
1.5 m		0150	
3.0 m		0300	
5.0 m		0500	
7.5 m		0750	
10.0 m		1000	
Technical Data			
Operating voltage		max. 600 V AC/DC	
Protection		IP68 inserted and tightened (EN 60529)	
Temperature range		-25...+80 °C, depending on cable quality	
Article No.			
The composition of your article number is explained on page 3.1.i		<div style="border-bottom: 1px solid black; width: 100px; display: inline-block; margin-right: 10px;">7 7 0 0</div> <div style="border-bottom: 1px solid black; width: 100px; display: inline-block; margin-right: 10px;">-</div> <div style="border-bottom: 1px solid black; width: 100px; display: inline-block; margin-right: 10px;">-</div> <div style="border-bottom: 1px solid black; width: 100px; display: inline-block; margin-right: 10px;">-</div> <div style="border-bottom: 1px solid black; width: 100px; display: inline-block; margin-right: 10px;">-</div>	
		<b>1</b> Form	<b>2</b> Cable Type
			<b>3</b> Cable Length
Notes		Other versions on request. Differing cable lengths up to 2 m can be ordered in 0.2 m steps, from 2 m on in 0.5 m steps.	

# TPE SERIES - THE NORTH AMERICAN STANDARD

With open ended wires

- 7/8" MINI

- Power

Approvals: 

\* only for products with UL/CSA approved cable

Female  
straight  
TC-ER



Female  
straight

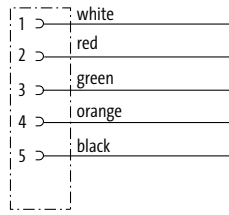
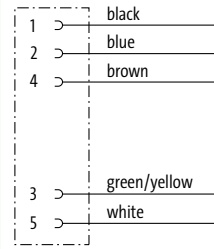
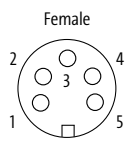

<b>1 Form</b>	<b>A 5021</b>	<b>A 5021</b>
	5-pole	5-pole
<b>Circuit diagram</b>		
<b>Contact layout</b>		
<b>2 Cable Type</b>	<b>Jacket Color</b>	<b>Jacket Color</b>
Wire diameter 1.5 mm <sup>2</sup> PUR (UL/CSA), C-tracks TPE (UL/CSA), robots	yellow U1D	black UMD
<b>3 Cable Length</b>		
1.5 m	0150	
3.0 m	0300	
5.0 m	0500	
7.5 m	0750	
10.0 m	1000	
<b>Technical Data</b>		
Operating voltage	max. 600 V AC/DC	
Protection	IP68 inserted and tightened (EN 60529)	
Temperature range	-25...+80 °C, depending on cable quality	
<b>Article No.</b>		
The composition of your article number is explained on page 3.1.i	<div style="display: flex; justify-content: space-around; align-items: center;"> <span style="border-bottom: 1px solid black; padding: 0 5px;">7</span> <span style="border-bottom: 1px solid black; padding: 0 5px;">7</span> <span style="border-bottom: 1px solid black; padding: 0 5px;">0</span> <span style="border-bottom: 1px solid black; padding: 0 5px;">0</span> <span style="font-size: 2em;">-</span> <span style="border-bottom: 1px dashed black; padding: 0 5px;"> </span> <span style="font-size: 2em;">-</span> <span style="border-bottom: 1px dashed black; padding: 0 5px;"> </span> <span style="border-bottom: 1px dashed black; padding: 0 5px;"> </span> </div>	
	<b>1 Form</b>	<b>2 Cable Type</b>
		<b>3 Cable Length</b>
<b>Notes</b>	Other versions on request. Differing cable lengths up to 2 m can be ordered in 0.2 m steps, from 2 m on in 0.5 m steps.	

TPE Series - The North American standard

# TPE SERIES - THE NORTH AMERICAN STANDARD

With open ended wires

- 7/8" MINI

- Power



\* only for products with UL/CSA approved cable

Female

90°  
TC-ER



Female

90°



1 Form		A3031	A3031
Type	3-pole		3-pole
Circuit diagram			
Contact layout			
2 Cable Type		Jacket Color	Jacket Color
Wire diameter 1.5 mm <sup>2</sup>	yellow	black	
PUR (UL/CSA), C-tracks		UMB	
TPE (UL/CSA), robots	U1B		
3 Cable Length			
1.5 m	0150		
3.0 m	0300		
5.0 m	0500		
7.5 m	0750		
10.0 m	1000		
Technical Data			
Operating voltage	max. 600 V AC/DC		
Protection	IP68 inserted and tightened (EN 60529)		
Temperature range	-25...+80 °C, depending on cable quality		
Article No.			
The composition of your article number is explained on page 3.1.i	<b>7 7 0 0</b> - - - - - - - - - -		
	<b>1</b> Form	<b>2</b> Cable Type	<b>3</b> Cable Length
Notes			
		Other versions on request. Differing cable lengths up to 2 m can be ordered in 0.2 m steps, from 2 m on in 0.5 m steps.	



# TPE SERIES - THE NORTH AMERICAN STANDARD

With open ended wires

- 7/8" MINI

- Power

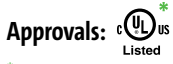

\* only for products with UL/CSA approved cable

Female

90°  
TC-ER



Female

90°



<b>1 Form</b>	<b>A 4 0 3 1</b>	<b>A 4 0 3 1</b>
	<p>Type 4-pole</p> <p>Circuit diagram</p>	<p>Type 4-pole</p> <p>Circuit diagram</p>
<p>Contact layout</p>	<p>Contact layout</p>	
<b>2 Cable Type</b>	<b>Jacket Color</b>	<b>Jacket Color</b>
<p>Wire diameter 1.5 mm<sup>2</sup> PUR (UL/CSA), C-tracks TPE (UL/CSA), robots</p>	<p>yellow</p> <p>U1C</p>	<p>black</p> <p>UMC</p>
<b>3 Cable Length</b>		
1.5 m	<b>0150</b>	
3.0 m	<b>0300</b>	
5.0 m	<b>0500</b>	
7.5 m	<b>0750</b>	
10.0 m	<b>1000</b>	
<b>Technical Data</b>		
Operating voltage	max. 600 V AC/DC	
Protection	IP68 inserted and tightened (EN 60529)	
Temperature range	-25...+80 °C, depending on cable quality	
<b>Article No.</b>		
<p>The composition of your article number is explained on page 3.1.i</p>	<p><u>7 7 0 0</u> - - - - - - - - - -</p>	<p>- - - - -</p>
	<b>1 Form</b>	<b>2 Cable Type</b>
		<b>3 Cable Length</b>
<b>Notes</b>	Other versions on request. Differing cable lengths up to 2 m can be ordered in 0.2 m steps, from 2 m on in 0.5 m steps.	

TPE Series - The North American standard

# TPE SERIES - THE NORTH AMERICAN STANDARD

With open ended wires

- 7/8" MINI

- Power

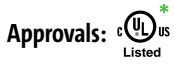

\* only for products with UL/CSA approved cable

**Female**

90°  
TC-ER



**Female**

90°



1 Form		A5031	A5031
Type		5-pole	5-pole
Circuit diagram			
Contact layout			
2 Cable Type		<b>Jacket Color</b>	<b>Jacket Color</b>
Wire diameter 1.5 mm <sup>2</sup>		yellow	black
PUR (UL/CSA), C-tracks			UMD
TPE (UL/CSA), robots		U1D	
3 Cable Length			
1.5 m		0150	
3.0 m		0300	
5.0 m		0500	
7.5 m		0750	
10.0 m		1000	
Technical Data			
Operating voltage		max. 600 V AC/DC	
Protection		IP68 inserted and tightened (EN 60529)	
Temperature range		-25...+80 °C, depending on cable quality	
Article No.			
The composition of your article number is explained on page 3.1.i		<div style="display: flex; justify-content: space-around; align-items: center;"> <span style="border-bottom: 1px solid black; padding: 0 5px;">7</span> <span style="border-bottom: 1px solid black; padding: 0 5px;">7</span> <span style="border-bottom: 1px solid black; padding: 0 5px;">0</span> <span style="border-bottom: 1px solid black; padding: 0 5px;">0</span> <span style="font-size: 2em;">-</span> <span style="border-bottom: 1px solid black; padding: 0 5px;"> </span> <span style="font-size: 2em;">-</span> <span style="border-bottom: 1px solid black; padding: 0 5px;"> </span> <span style="border-bottom: 1px solid black; padding: 0 5px;"> </span> </div>	
		<b>1 Form</b>	<b>2 Cable Type</b>
			<b>3 Cable Length</b>
Notes		Other versions on request. Differing cable lengths up to 2 m can be ordered in 0.2 m steps, from 2 m on in 0.5 m steps.	

# TPE SERIES - THE NORTH AMERICAN STANDARD

## Connection cables

- 7/8" MINI - 7/8" MINI

- Power

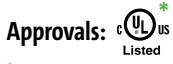

\* only for products with UL/CSA approved cable

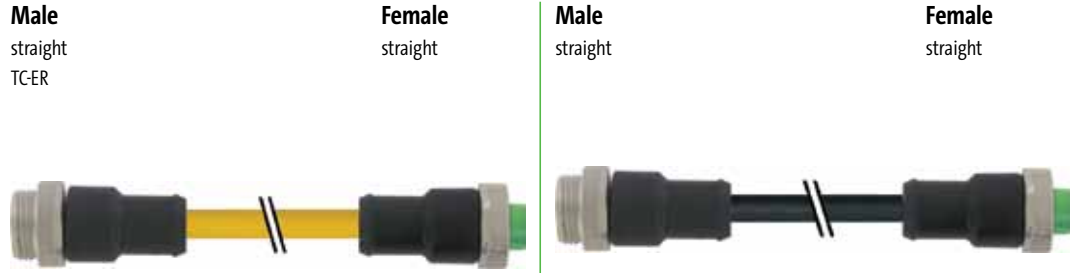

<b>1 Form</b>	<b>A3A01</b>	<b>A3A01</b>
	3-pole	3-pole
<b>Circuit diagram</b>		
<b>Contact layout</b>		
<b>2 Cable Type</b>	<b>Jacket Color</b>	<b>Jacket Color</b>
Wire diameter 1.5 mm <sup>2</sup> PUR (UL/CSA), C-tracks TPE (UL/CSA), robots	yellow U1B	black UMB
<b>3 Cable Length</b>		
1.5 m	0150	
3.0 m	0300	
5.0 m	0500	
7.5 m	0750	
10.0 m	1000	
<b>Technical Data</b>		
Operating voltage	max. 600 V AC/DC	
Protection	IP68 inserted and tightened (EN 60529)	
Temperature range	-25...+80 °C, depending on cable quality	
<b>Article No.</b>		
The composition of your article number is explained on page 3.1.i	<b>7 7 0 0</b> - - - - - - - - - -	
	<b>1 Form</b>	<b>2 Cable Type</b>
		<b>3 Cable Length</b>
<b>Notes</b>	Other versions on request. Differing cable lengths up to 2 m can be ordered in 0.2 m steps, from 2 m on in 0.5 m steps.	

TPE Series - The North American standard

# TPE SERIES - THE NORTH AMERICAN STANDARD

## Connection cables

– 7/8" MINI - 7/8" MINI

– Power

### Male

90°  
TC-ER

### Female

90°

### Male

90°

### Female

90°



Approvals: 

\* only for products with UL/CSA approved cable

1 Form		A3A31	A3A31
Type		3-pole	3-pole
Circuit diagram			
Contact layout			
2 Cable Type		Jacket Color	Jacket Color
Wire diameter 1.5 mm <sup>2</sup>		yellow	black
PUR (UL/CSA), C-tracks			UMB
TPE (UL/CSA), robots		U1B	
3 Cable Length			
1.5 m		0150	
3.0 m		0300	
5.0 m		0500	
7.5 m		0750	
10.0 m		1000	
Technical Data			
Operating voltage		max. 600 V AC/DC	
Protection		IP68 inserted and tightened (EN 60529)	
Temperature range		-25...+80 °C, depending on cable quality	
Article No.			
The composition of your article number is explained on page 3.1.i		7 7 0 0 - - - - - - - - - -	- - - - -
		1 Form	2 Cable Type
			3 Cable Length
Notes		Other versions on request. Differing cable lengths up to 2 m can be ordered in 0.2 m steps, from 2 m on in 0.5 m steps.	

# TPE SERIES - THE NORTH AMERICAN STANDARD

## Connection cables

- 7/8" MINI - 7/8" MINI

- Power

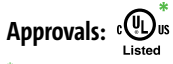

\* only for products with UL/CSA approved cable

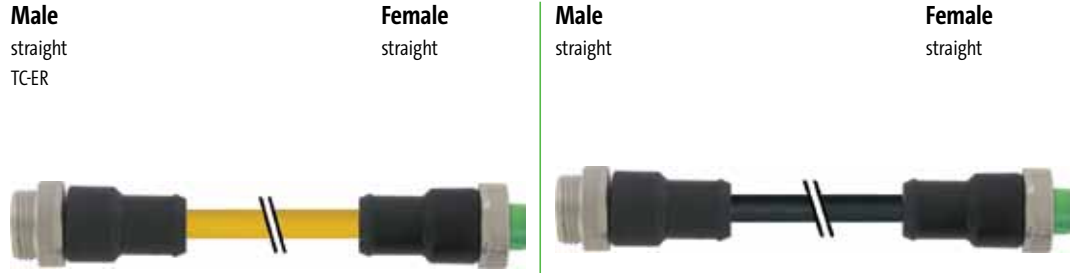

1 Form		A4A01	A4A01
Type		4-pole	4-pole
Circuit diagram			
Contact layout			
2 Cable Type		Jacket Color	Jacket Color
Wire diameter 1.5 mm <sup>2</sup> PUR (UL/CSA), C-tracks TPE (UL/CSA), robots		yellow U1C	black UMC
3 Cable Length			
1.5 m		0150	
3.0 m		0300	
5.0 m		0500	
7.5 m		0750	
10.0 m		1000	
Technical Data			
Operating voltage		max. 600 V AC/DC	
Protection		IP68 inserted and tightened (EN 60529)	
Temperature range		-25...+80 °C, depending on cable quality	
Article No.			
The composition of your article number is explained on page 3.1.i		7 7 0 0 - - - - -	- - - - -
		1 Form	2 Cable Type 3 Cable Length
Notes		Other versions on request. Differing cable lengths up to 2 m can be ordered in 0.2 m steps, from 2 m on in 0.5 m steps.	

TPE Series - The North American standard

# TPE SERIES - THE NORTH AMERICAN STANDARD

## Connection cables

– 7/8" MINI - 7/8" MINI

– Power

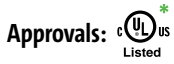

\* only for products with UL/CSA approved cable

### Male

90°  
TC-ER

### Female

90°



### Male

90°

### Female

90°



## 1 Form

### A 4 A 3 1

### A 4 A 3 1

#### Type

4-pole

4-pole

#### Circuit diagram

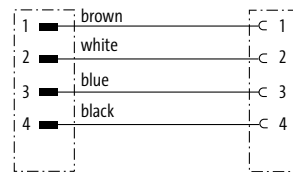
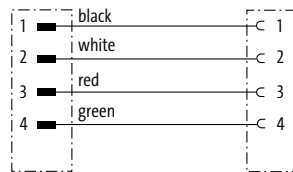

#### Contact layout

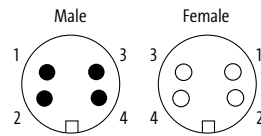
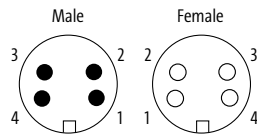

## 2 Cable Type

### Jacket Color

### Jacket Color

Wire diameter 1.5 mm<sup>2</sup>

PUR (UL/CSA), C-tracks

TPE (UL/CSA), robots

yellow

U1C

black

UMC

## 3 Cable Length

1.5 m

0150

3.0 m

0300

5.0 m

0500

7.5 m

0750

10.0 m

1000

### Technical Data

Operating voltage

max. 600 V AC/DC

Protection

IP68 inserted and tightened (EN 60529)

Temperature range

-25...+80 °C, depending on cable quality

### Article No.

The composition of your article number is explained on page 3.1.i

**7 7 0 0** - - - - -

**1** Form

**2** Cable Type

**3** Cable Length

### Notes

Other versions on request. Differing cable lengths up to 2 m can be ordered in 0.2 m steps, from 2 m on in 0.5 m steps.

# TPE SERIES - THE NORTH AMERICAN STANDARD

## Connection cables

- 7/8" MINI - 7/8" MINI

- Power

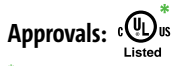

\* only for products with UL/CSA approved cable

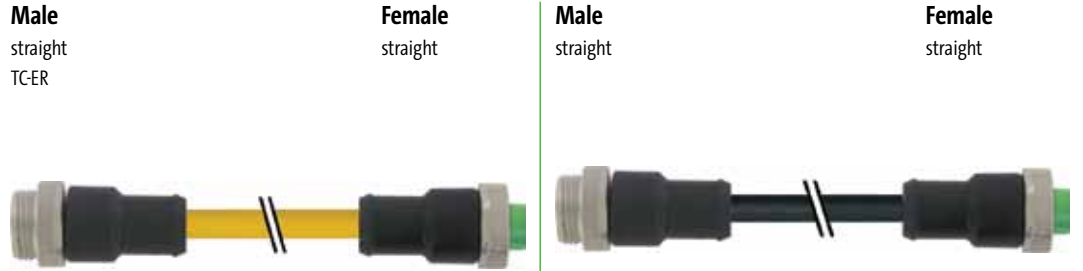

1 Form		A5A01	A5A01
Type	5-pole	5-pole	5-pole
Circuit diagram			
Contact layout			
2 Cable Type		Jacket Color	Jacket Color
Wire diameter 1.5 mm <sup>2</sup>		yellow	black
PUR (UL/CSA), C-tracks			UMD
TPE (UL/CSA), robots		U1D	
3 Cable Length			
1.5 m	0150		
3.0 m	0300		
5.0 m	0500		
7.5 m	0750		
10.0 m	1000		
Technical Data			
Operating voltage	max. 600 V AC/DC		
Protection	IP68 inserted and tightened (EN 60529)		
Temperature range	-25...+80 °C, depending on cable quality		
Article No.			
The composition of your article number is explained on page 3.1.i	<div style="display: flex; align-items: center; gap: 10px;"> <span style="border-bottom: 1px solid black; padding: 0 5px;">7</span> <span style="border-bottom: 1px solid black; padding: 0 5px;">7</span> <span style="border-bottom: 1px solid black; padding: 0 5px;">0</span> <span style="border-bottom: 1px solid black; padding: 0 5px;">0</span> <span style="font-size: 2em;">-</span> <span style="border-bottom: 1px solid black; padding: 0 5px;">_</span> <span style="font-size: 2em;">-</span> <span style="border-bottom: 1px solid black; padding: 0 5px;">_</span> <span style="border-bottom: 1px solid black; padding: 0 5px;">_</span> </div>		
	<b>1</b> Form	<b>2</b> Cable Type	<b>3</b> Cable Length
Notes	Other versions on request. Differing cable lengths up to 2 m can be ordered in 0.2 m steps, from 2 m on in 0.5 m steps.		

# TPE SERIES - THE NORTH AMERICAN STANDARD

## Connection cables

– 7/8" MINI - 7/8" MINI

– Power

### Male

90°  
TC-ER

### Female

90°

### Male

90°

### Female

90°



Approvals: 

\* only for products with UL/CSA approved cable

1 Form		A5A31	A5A31
Type		5-pole	5-pole
Circuit diagram			
Contact layout			
2 Cable Type		Jacket Color	Jacket Color
Wire diameter 1.5 mm <sup>2</sup>		yellow	black
PUR (UL/CSA), Ctracks			UMD
TPE (UL/CSA), robots		U1D	
3 Cable Length			
1.5 m		0150	
3.0 m		0300	
5.0 m		0500	
7.5 m		0750	
10.0 m		1000	
Technical Data			
Operating voltage		max. 600 V AC/DC	
Protection		IP68 inserted and tightened (EN 60529)	
Temperature range		-25...+80 °C, depending on cable quality	
Article No.			
The composition of your article number is explained on page 3.1.i		7 7 0 0	- - - - -
		1 Form	2 Cable Type
			3 Cable Length
Notes			
		Other versions on request. Differing cable lengths up to 2 m can be ordered in 0.2 m steps, from 2 m on in 0.5 m steps.	











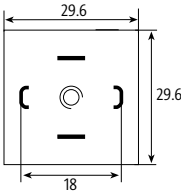

# VALVE CONNECTORS MORE MODELS THAN EVER

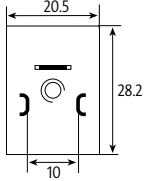
- Molded construction – resistant to shock and vibration
- Tested to ensure reliability
- IP65 to IP67 Rated

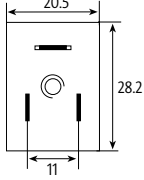
## THE CONNECTOR FOR VALVES AND PRESSURE SWITCHES

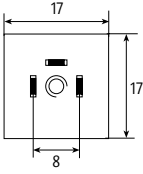
25 years ago, Murrelektronik developed and produced the first pre-wired and molded valve connector. It was a revolution! Now, more than ever, Murrelektronik's valve plugs enjoy long-running success as a result of continuous improvement. A captive gasket, integrated LED status indicator and suppression are the top features of Murrelektronik's MSUD valve plug.

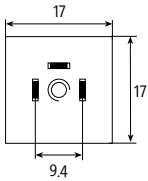
With Open Ended Wires		Valve Diagram		
		<b>MSUD Valve Connector</b>	<ul style="list-style-type: none"> <li>• Form A</li> <li>acc. to EN 175301-803 (ISO 4400)</li> <li>Pin spacing 18 mm</li> </ul>	Page 3.12.1
		<b>MSUD Valve Connector</b>	<ul style="list-style-type: none"> <li>• Form B</li> <li>acc. to EN 175301-803 (ISO 6952)</li> <li>Pin spacing 10 mm</li> </ul>	Page 3.12.4
		<b>MSUD Valve Connector</b>	<ul style="list-style-type: none"> <li>• Form BI</li> <li>Industrial standard</li> <li>Pin spacing 11 mm</li> </ul>	Page 3.12.6
		<b>MSUD Valve Connector</b>	<ul style="list-style-type: none"> <li>• Form C</li> <li>acc. to EN 175301-803 (ISO 6952)</li> <li>Pin spacing 8 mm</li> </ul>	Page 3.12.8
		<b>MSUD Valve Connector</b>	<ul style="list-style-type: none"> <li>• Form CI</li> <li>Industrial standard</li> <li>Pin spacing 9.4 mm</li> </ul>	Page 3.12.10

## Connection Cables

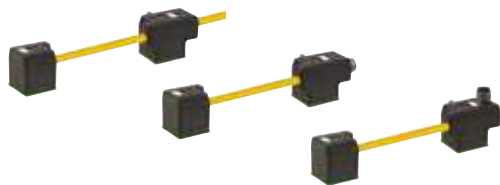

### MSUD Double Valve Connector

- Form A
- Form B
- Form BI
- Form C
- Form CI

### M12 male

- Top connection
- Rear connection
- With connection cable

Page 3.12.12

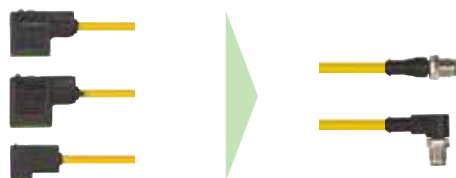

### MSUD Valve Connector

- Form A
- Form B
- Form BI
- Form C
- Form CI

### M12 male

- Straight
- 90°

Page 3.12.19



### MSUD Valve Connector Adapter

- Form A
- Form B
- Form BI
- Form C
- Form CI

### M12 male

- Top connection
- Rear connection

Page 3.12.23

## Field-Wireable



### Screw Terminals

### SVS Valve Connector

- Form A
- Form B
- Form BI

Page 3.12.27



### Insulation Displacement Technology (IDC)

### MOSA Valve Connector

- Form C
- Form CI

Page 3.12.35



### Screw Terminals

### SVS Eco Valve Connector

- Form A
- Form B
- Form BI
- Form C
- Form CI

Page 3.12.36

# VALVE CONNECTORS

MSUD

– with open ended wires

Form A (18 mm)

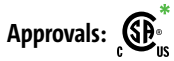

\* only for products with UL/CSA approved cable

1 Form	18001	18021	18041						
Type	24 V AC/DC ±25%	24 V AC ±20% / DC ±25%	110 V AC/DC ±10%						
Circuit diagram	<p>LED</p>	<p>LED and suppression</p>	<p>LED and suppression</p>						
Contact layout									
2 Cable Type	Jacket Color								
Wire diameter 0.75 mm <sup>2</sup>	yellow	gray	black	yellow	gray	black	yellow	gray	black
PVC	016	216	616	016	216	616	016	216	616
PUR/PVC (UL/CSA)	026	226	626	026	226	626	026	226	626
PUR (UL/CSA), robots/C-tracks	036	236	636	036	236	636	036	236	636
PUR (UL/CSA), welding spark	056	256	656	056	256	656	056	256	656
3 Cable Length									
1.5 m	0150								
3.0 m	0300								
5.0 m	0500								
7.5 m	0750								
10.0 m	1000								
Technical Data									
Operating voltage	24 V AC/DC ±25%		24 V AC ±20% / DC ±25%			110 V AC/DC ±10%			
Protection	IP67 inserted and tightened (EN 60529)								
Temperature range	-25...+85 °C, depending on cable quality								
Article No.									
The composition of your article number is explained on page 3.1.i	<div style="display: flex; justify-content: space-around; align-items: center;"> <span style="border-bottom: 1px solid black; padding: 0 5px;">7</span> <span style="border-bottom: 1px solid black; padding: 0 5px;">0</span> <span style="border-bottom: 1px solid black; padding: 0 5px;">0</span> <span style="border-bottom: 1px solid black; padding: 0 5px;">0</span> <span style="font-size: 2em;">-</span> <span style="border-bottom: 1px solid black; padding: 0 5px;"> </span> <span style="font-size: 2em;">-</span> <span style="border-bottom: 1px solid black; padding: 0 5px;"> </span> <span style="border-bottom: 1px solid black; padding: 0 5px;"> </span> <span style="border-bottom: 1px solid black; padding: 0 5px;"> </span> </div>								
	<b>1 Form</b>		<b>2 Cable Type</b>			<b>3 Cable Length</b>			
Notes	Other versions on request. Differing cable lengths up to 2 m can be ordered in 0.2 m steps, from 2 m on in 0.5 m steps.								

# VALVE CONNECTORS

MSUD

– with open ended wires

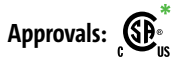

\* only for products with UL/CSA approved cable

Form A (18 mm)



<b>1 Form</b>	<b>18061</b>	<b>18081</b>	
	Type 230 V AC/DC ±10% LED and suppression	max. 230 V AC/DC without components	
	Circuit diagram		
Contact layout			
<b>2 Cable Type</b>	<b>Jacket Color</b>	<b>Jacket Color</b>	
	Wire diameter 0.75 mm <sup>2</sup>	yellow    gray    black	yellow    gray    black
	PVC	016    216    616	016    216    616
	PUR/PVC (UL/CSA)	026    226    626	026    226    626
	PUR (UL/CSA), robots/C-tracks PUR (UL/CSA), welding spark	036    236    636 056    256    656	036    236    636 056    256    656
<b>3 Cable Length</b>	1.5 m	0150	
	3.0 m	0300	
	5.0 m	0500	
	7.5 m	0750	
	10.0 m	1000	
<b>Technical Data</b>	Operating voltage	230 V AC/DC ±10%	max. 230 V AC/DC
	Protection	IP67 inserted and tightened (EN 60529)	
	Temperature range	-25...+85 °C, depending on cable quality	
<b>Article No.</b>	The composition of your article number is explained on page 3.1.i		
	<div style="display: flex; justify-content: space-around; align-items: center;"> <span style="border-bottom: 1px solid black; padding: 0 5px;">7</span> <span style="border-bottom: 1px solid black; padding: 0 5px;">0</span> <span style="border-bottom: 1px solid black; padding: 0 5px;">0</span> <span style="border-bottom: 1px solid black; padding: 0 5px;">0</span> <span style="font-size: 2em;">-</span> <span style="border-bottom: 1px solid black; padding: 0 5px;"> </span> <span style="font-size: 2em;">-</span> <span style="border-bottom: 1px solid black; padding: 0 5px;"> </span> <span style="border-bottom: 1px solid black; padding: 0 5px;"> </span> <span style="border-bottom: 1px solid black; padding: 0 5px;"> </span> </div>		
	<b>1 Form</b>	<b>2 Cable Type</b>	<b>3 Cable Length</b>
<b>Notes</b>	Other versions on request. Differing cable lengths up to 2 m can be ordered in 0.2 m steps, from 2 m on in 0.5 m steps.		

Valve Connectors

# VALVE CONNECTORS

MSUD

– with open ended wires

– for pressure switches

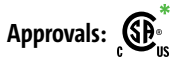

\* only for products with UL/CSA approved cable

Form A (18 mm)



1 Form	18121				18141	
Type	24 V DC ±25%				24 V DC ±25%	
	LED (red/green)				LED (yellow/green)	
Circuit diagram						
Contact layout						
2 Cable Type	Jacket Color			Jacket Color		
Wire diameter 0.75 mm <sup>2</sup>	yellow	gray	black	yellow	gray	black
PVC	018	218	618	018	218	618
PUR/PVC (UL/CSA)	028	228	628	028	228	628
PUR (UL/CSA), robots/Ctracks	038	238	638	038	238	638
3 Cable Length						
1.5 m	0150					
3.0 m	0300					
5.0 m	0500					
7.5 m	0750					
10.0 m	1000					
Technical Data						
Operating voltage	24 V DC ±25%					
Protection	IP67 inserted and tightened (EN 60529)					
Temperature range	-25...+85 °C, depending on cable quality					
Article No.						
The composition of your article number is explained on page 3.1.i	<span style="font-size: 1.2em; font-weight: bold;">7 0 0 0</span> - - - - -					
	<b>1</b>	<b>Form</b>		<b>2</b>	<b>Cable Type</b>	
	<b>3</b>			<b>Cable Length</b>		
Notes						
	Other versions on request. Differing cable lengths up to 2 m can be ordered in 0.2 m steps, from 2 m on in 0.5 m steps.					

# VALVE CONNECTORS

MSUD

– with open ended wires

Form B (10 mm)



Approvals:

\* only for products with UL/CSA approved cable

1 Form	10001	10021	10041						
Type	24 V AC/DC ±25%	24 V AC ±20% / DC ±25%	110 V AC/DC ±10%						
	LED	LED and suppression	LED and suppression						
Circuit diagram									
Contact layout									
2 Cable Type	Jacket Color								
Wire diameter 0.75 mm <sup>2</sup>	yellow	gray	black	yellow	gray	black	yellow	gray	black
PVC	016	216	616	016	216	616	016	216	616
PUR/PVC (UL/CSA)	026	226	626	026	226	626	026	226	626
PUR (UL/CSA), robots/C-tracks	036	236	636	036	236	636	036	236	636
PUR (UL/CSA), welding spark	056	256	656	056	256	656	056	256	656
3 Cable Length									
1.5 m	0150								
3.0 m	0300								
5.0 m	0500								
7.5 m	0750								
10.0 m	1000								
Technical Data									
Operating voltage	24 V AC/DC ±25%			24 V AC ±20% / DC ±25%			110 V AC/DC ±10%		
Protection	IP67 inserted and tightened (EN 60529)								
Temperature range	-25...+85 °C, depending on cable quality								
Article No.									
The composition of your article number is explained on page 3.1.i	<div style="display: flex; justify-content: space-around; align-items: center;"> <span style="border-bottom: 1px solid black; padding: 0 5px;">7</span> <span style="border-bottom: 1px solid black; padding: 0 5px;">0</span> <span style="border-bottom: 1px solid black; padding: 0 5px;">0</span> <span style="border-bottom: 1px solid black; padding: 0 5px;">0</span> <span style="font-size: 2em;">-</span> <span style="border-bottom: 1px solid black; padding: 0 5px;">_</span> <span style="border-bottom: 1px solid black; padding: 0 5px;">_</span> <span style="border-bottom: 1px solid black; padding: 0 5px;">_</span> <span style="border-bottom: 1px solid black; padding: 0 5px;">_</span> <span style="border-bottom: 1px solid black; padding: 0 5px;">_</span> <span style="border-bottom: 1px solid black; padding: 0 5px;">_</span> <span style="border-bottom: 1px solid black; padding: 0 5px;">_</span> </div>								
	<b>1 Form</b>			<b>2 Cable Type</b>			<b>3 Cable Length</b>		
Notes	Other versions on request. Differing cable lengths up to 2 m can be ordered in 0.2 m steps, from 2 m on in 0.5 m steps.								

Valve Connectors

# VALVE CONNECTORS

MSUD

– with open ended wires

Form B (10 mm)



Approvals: 

\* only for products with UL/CSA approved cable

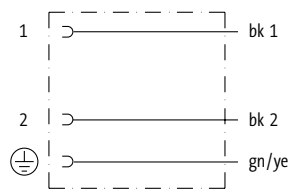
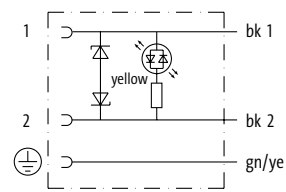
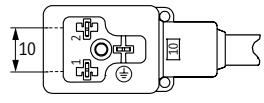
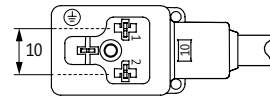
1 Form	10061	10081
Type	max. 230 V AC/DC without components	24 V AC ±20% / DC ±25% LED and suppression
Circuit diagram		
Contact figure	PE at cable entry (0°)	PE opposite cable entry (180°)
Contact layout		
2 Cable Type	Jacket Color	Jacket Color
Wire diameter 0.75 mm <sup>2</sup>	yellow    gray    black	yellow    gray    black
PVC	016    216    616	016    216    616
PUR/PVC (UL/CSA)	026    226    626	026    226    626
PUR (UL/CSA), robots/C-tracks	036    236    636	036    236    636
PUR (UL/CSA), welding spark	056    256    656	056    256    656
3 Cable Length		
1.5 m	0150	
3.0 m	0300	
5.0 m	0500	
7.5 m	0750	
10.0 m	1000	
Technical Data		
Operating voltage	max. 230 V AC/DC	24 V AC ±20% / DC ±25%
Protection	IP67 inserted and tightened (EN 60529)	
Temperature range	-25...+85 °C, depending on cable quality	
Article No.		
The composition of your article number is explained on page 3.1.i	<div style="display: flex; justify-content: space-around; align-items: center;"> <span style="border-bottom: 1px solid black; padding: 0 5px;">7</span> <span style="border-bottom: 1px solid black; padding: 0 5px;">0</span> <span style="border-bottom: 1px solid black; padding: 0 5px;">0</span> <span style="border-bottom: 1px solid black; padding: 0 5px;">0</span> <span style="font-size: 2em;">-</span> <span style="border-bottom: 1px solid black; padding: 0 5px;"> </span> <span style="font-size: 2em;">-</span> <span style="border-bottom: 1px solid black; padding: 0 5px;"> </span> <span style="border-bottom: 1px solid black; padding: 0 5px;"> </span> <span style="border-bottom: 1px solid black; padding: 0 5px;"> </span> </div>	
	<b>1</b> Form	<b>2</b> Cable Type
		<b>3</b> Cable Length
Notes	Other versions on request. Differing cable lengths up to 2 m can be ordered in 0.2 m steps, from 2 m on in 0.5 m steps.	

# VALVE CONNECTORS

MSUD

– with open ended wires

**Form BI (11 mm)**

Industrial standard



\* only for products with UL/CSA approved cable

1 Form	11001	11021	11041						
Type	24 V AC/DC ±25%	24 V AC ±20% / DC ±25%	110 V AC/DC ±10%						
Circuit diagram									
Contact layout									
2 Cable Type	Jacket Color								
Wire diameter 0.75 mm <sup>2</sup>	yellow	gray	black	yellow	gray	black	yellow	gray	black
PVC	016	216	616	016	216	616	016	216	616
PUR/PVC (UL/CSA)	026	226	626	026	226	626	026	226	626
PUR (UL/CSA), robots/C-tracks	036	236	636	036	236	636	036	236	636
PUR (UL/CSA), welding spark	056	256	656	056	256	656	056	256	656
3 Cable Length									
1.5 m	0150								
3.0 m	0300								
5.0 m	0500								
7.5 m	0750								
10.0 m	1000								
Technical Data									
Operating voltage	24 V AC/DC ±25%			24 V AC ±20% / DC ±25%			110 V AC/DC ±10%		
Protection	IP67 inserted and tightened (EN 60529)								
Temperature range	-25...+85 °C, depending on cable quality								
Article No.									
The composition of your article number is explained on page 3.1.i	<div style="display: flex; justify-content: space-around; align-items: center;"> <span style="border-bottom: 1px solid black; padding: 0 5px;">7</span> <span style="border-bottom: 1px solid black; padding: 0 5px;">0</span> <span style="border-bottom: 1px solid black; padding: 0 5px;">0</span> <span style="border-bottom: 1px solid black; padding: 0 5px;">0</span> <span style="font-size: 1.5em;">-</span> <span style="border-bottom: 1px solid black; padding: 0 5px;">_</span> <span style="border-bottom: 1px solid black; padding: 0 5px;">_</span> <span style="border-bottom: 1px solid black; padding: 0 5px;">_</span> <span style="border-bottom: 1px solid black; padding: 0 5px;">_</span> <span style="border-bottom: 1px solid black; padding: 0 5px;">_</span> <span style="border-bottom: 1px solid black; padding: 0 5px;">_</span> <span style="border-bottom: 1px solid black; padding: 0 5px;">_</span> </div>								
	<b>1 Form</b>			<b>2 Cable Type</b>			<b>3 Cable Length</b>		
Notes	Other versions on request. Differing cable lengths up to 2 m can be ordered in 0.2 m steps, from 2 m on in 0.5 m steps.								

Valve Connectors



# VALVE CONNECTORS

MSUD

– with open ended wires

**Form BI (11 mm)**

Industrial standard



Approvals: 

\* only for products with UL/CSA approved cable

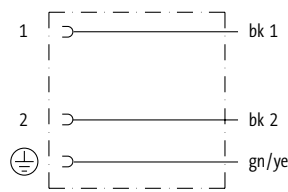
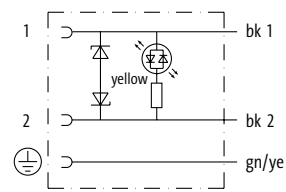
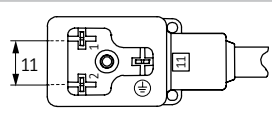
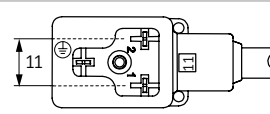
1 Form		11061	11081				
Type		max. 250 V AC/DC without components	24 V AC ±20% / DC ±25% LED and suppression				
Circuit diagram							
Contact figure		PE at cable entry (0°)	PE opposite cable entry (180°)				
Contact layout							
2 Cable Type		Jacket Color					
Wire diameter 0.75 mm <sup>2</sup>		yellow	gray	black	yellow	gray	black
PVC		016	216	616	016	216	616
PUR/PVC (UL/CSA)		026	226	626	026	226	626
PUR (UL/CSA), robots/C-tracks		036	236	636	036	236	636
PUR (UL/CSA), welding spark		056	256	656	056	256	656
3 Cable Length							
1.5 m		0150					
3.0 m		0300					
5.0 m		0500					
7.5 m		0750					
10.0 m		1000					
Technical Data							
Operating voltage		max. 250 V AC/DC			24 V AC ±20% / DC ±25%		
Protection		IP67 inserted and tightened (EN 60529)					
Temperature range		-25...+85 °C, depending on cable quality					
Article No.							
The composition of your article number is explained on page 3.1.i		7 0 0 0		-	-		-
		1 Form		2 Cable Type		3 Cable Length	
Notes		Other versions on request. Differing cable lengths up to 2 m can be ordered in 0.2 m steps, from 2 m on in 0.5 m steps.					

# VALVE CONNECTORS

MSUD

– with open ended wires

Form C (8 mm)

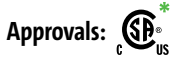

\* only for products with UL/CSA approved cable

1 Form		80001	80021				
Type	24 V AC/DC ±25%	LED	24 V AC ±20% / DC ±25%				
Circuit diagram							
Contact layout							
2 Cable Type		Jacket Color			Jacket Color		
Wire diameter 0.75 mm <sup>2</sup>	yellow	gray	black	yellow	gray	black	
PVC	016	216	616	016	216	616	
PUR/PVC (UL/CSA)	026	226	626	026	226	626	
PUR (UL/CSA), robots/C-tracks	036	236	636	036	236	636	
PUR (UL/CSA), welding spark	056	256	656	056	256	656	
3 Cable Length							
1.5 m	0150						
3.0 m	0300						
5.0 m	0500						
7.5 m	0750						
10.0 m	1000						
Technical Data							
Operating voltage	24 V AC/DC ±25%		24 V AC ±20% / DC ±25%				
Protection	IP67 inserted and tightened (EN 60529)						
Temperature range	-25...+85 °C, depending on cable quality						
Article No.							
The composition of your article number is explained on page 3.1.i	7 0 0 0		-		-		
	1 Form		2 Cable Type		3 Cable Length		
Notes		Other versions on request. Differing cable lengths up to 2 m can be ordered in 0.2 m steps, from 2 m on in 0.5 m steps.					

Valve Connectors

# VALVE CONNECTORS

MSUD

– with open ended wires

Form C (8 mm)



Approvals:

\* only for products with UL/CSA approved cable

1 Form	80041	80061
Type	110 V AC/DC ±10%	max. 230 V AC/DC
Circuit diagram	<p>LED and suppression</p>	<p>without components</p>
Contact layout		
2 Cable Type	Jacket Color	Jacket Color
Wire diameter 0.75 mm <sup>2</sup>	yellow    gray    black	yellow    gray    black
PVC	016    216    616	016    216    616
PUR/PVC (UL/CSA)	026    226    626	026    226    626
PUR (UL/CSA), robots/C-tracks	036    236    636	036    236    636
PUR (UL/CSA), welding spark	056    256    656	056    256    656
3 Cable Length		
1.5 m	0150	
3.0 m	0300	
5.0 m	0500	
7.5 m	0750	
10.0 m	1000	
Technical Data		
Operating voltage	110 V AC/DC ±10%	max. 230 V AC/DC
Protection	IP67 inserted and tightened (EN 60529)	
Temperature range	-25...+85 °C, depending on cable quality	
Article No.		
The composition of your article number is explained on page 3.1.i	<p><u>7 0 0 0</u> - - - - - - - - - -</p>	
	<b>1</b> Form	<b>2</b> Cable Type
		<b>3</b> Cable Length
Notes	Other versions on request. Differing cable lengths up to 2 m can be ordered in 0.2 m steps, from 2 m on in 0.5 m steps.	

# VALVE CONNECTORS

MSUD

– with open ended wires

Form CI (9.4 mm)

Industrial standard

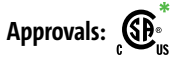

\* only for products with UL/CSA approved cable

1 Form		94001	94021				
Type		24 V AC/DC ±25%	24 V AC ±20% / DC ±25%				
Circuit diagram		<p>LED</p>	<p>LED and suppression</p>				
Contact layout							
2 Cable Type		Jacket Color			Jacket Color		
Wire diameter 0.75 mm <sup>2</sup>		yellow	gray	black	yellow	gray	black
PVC		016	216	616	016	216	616
PUR/PVC (UL/CSA)		026	226	626	026	226	626
PUR (UL/CSA), robots/C-tracks		036	236	636	036	236	636
PUR (UL/CSA), welding spark		056	256	656	056	256	656
3 Cable Length							
1.5 m		0150					
3.0 m		0300					
5.0 m		0500					
7.5 m		0750					
10.0 m		1000					
Technical Data							
Operating voltage		24 V AC/DC ±25%			24 V AC ±20% / DC ±25%		
Protection		IP67 inserted and tightened (EN 60529)					
Temperature range		-25...+85 °C, depending on cable quality					
Article No.							
The composition of your article number is explained on page 3.1.i		7 0 0 0		-	-		-
		1 Form		2 Cable Type		3 Cable Length	
Notes		Other versions on request. Differing cable lengths up to 2 m can be ordered in 0.2 m steps, from 2 m on in 0.5 m steps.					

Valve Connectors

# VALVE CONNECTORS

MSUD

– with open ended wires

**Form CI (9.4 mm)**

Industrial standard



Approvals: 

\* only for products with UL/CSA approved cable

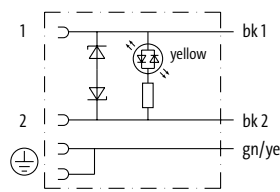
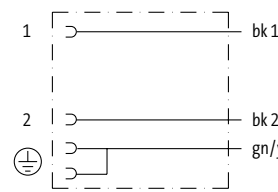
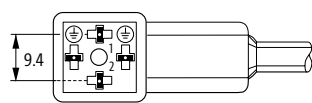
<b>1 Form</b>	<b>94041</b>	<b>94061</b>	
	Type 110 V AC/DC ±10% LED and suppression	max. 230 V AC/DC without components	
Circuit diagram			
Contact layout			
<b>2 Cable Type</b>	<b>Jacket Color</b>	<b>Jacket Color</b>	
	Wire diameter 0.75 mm <sup>2</sup>	yellow    gray    black	yellow    gray    black
	PVC	016    216    616	016    216    616
	PUR/PVC (UL/CSA)	026    226    626	026    226    626
	PUR (UL/CSA), robots/C-tracks PUR (UL/CSA), welding spark	036    236    636 056    256    656	036    236    636 056    256    656
<b>3 Cable Length</b>	1.5 m	0150	
	3.0 m	0300	
	5.0 m	0500	
	7.5 m	0750	
	10.0 m	1000	
<b>Technical Data</b>	Operating voltage: 110 V AC/DC ±10%	max. 230 V AC/DC	
Protection	IP67 inserted and tightened (EN 60529)		
Temperature range	-25...+85 °C, depending on cable quality		
<b>Article No.</b>	<div style="border: 1px solid black; padding: 5px; display: flex; justify-content: space-around;"> <span><b>7 0 0 0</b></span> <span>-</span> <span>_____</span> <span>-</span> <span>_____</span> <span>-</span> <span>_____</span> </div>		
The composition of your article number is explained on page 3.1.i	<b>1 Form</b>	<b>2 Cable Type</b>	
		<b>3 Cable Length</b>	
<b>Notes</b>	Other versions on request. Differing cable lengths up to 2 m can be ordered in 0.2 m steps, from 2 m on in 0.5 m steps.		

# VALVE CONNECTORS

MSUD - MSUD

– Double valve plugs with connection cable

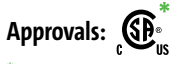

\* only for products with UL/CSA approved cable

Form A (18 mm)



<b>1 Form</b>	<b>58001</b>	<b>58021</b>	<b>58041</b>							
	Type	24 V AC ±20% / DC ±25%	24 V AC ±20% / DC ±25%	24 V AC ±20% / DC ±25%						
	LED and suppression	LED and suppression	LED and suppression							
	L = 110 mm	L = 150 mm	L = 200 mm							
<b>Circuit diagram</b>										
<b>Contact layout</b>										
<b>2 Cable Type</b>	<b>Jacket Color</b>	<b>Jacket Color</b>								
	Wire diameter 0.75 mm <sup>2</sup>	yellow	gray	black	yellow	gray	black	yellow	gray	black
	PVC	017	217	617	017	217	617	017	217	617
	PUR/PVC (UL/CSA)	027	227	627	027	227	627	027	227	627
	PUR (UL/CSA), robots/Ctracks	037	237	637	037	237	637	037	237	637
<b>3 Cable Length</b>	1.5 m	0150								
	3.0 m	0300								
	5.0 m	0500								
	7.5 m	0750								
	10.0 m	1000								
<b>Technical Data</b>										
Operating voltage	24 V AC ±20% / DC ±25%									
Protection	IP67 inserted and tightened (EN 60529)									
Temperature range	-25...+85 °C, depending on cable quality									
<b>Article No.</b>										
The composition of your article number is explained on page 3.1.i	<div style="display: flex; justify-content: space-around; align-items: center;"> <span style="border-bottom: 1px solid black; padding: 0 5px;">7</span> <span style="border-bottom: 1px solid black; padding: 0 5px;">0</span> <span style="border-bottom: 1px solid black; padding: 0 5px;">0</span> <span style="border-bottom: 1px solid black; padding: 0 5px;">0</span> <span style="font-size: 2em;">-</span> <span style="border-bottom: 1px solid black; padding: 0 5px;"> </span> <span style="font-size: 2em;">-</span> <span style="border-bottom: 1px solid black; padding: 0 5px;"> </span> <span style="border-bottom: 1px solid black; padding: 0 5px;"> </span> <span style="border-bottom: 1px solid black; padding: 0 5px;"> </span> </div>									
	<b>1 Form</b>			<b>2 Cable Type</b>			<b>3 Cable Length</b>			
<b>Notes</b>	Other versions on request. Differing cable lengths up to 2 m can be ordered in 0.2 m steps, from 2 m on in 0.5 m steps.									

Valve Connectors

# VALVE CONNECTORS

MSUD - MSUD

– Double valve plugs with connection cable

Form B (10 mm)



Approvals: 

\* only for products with UL/CSA approved cable

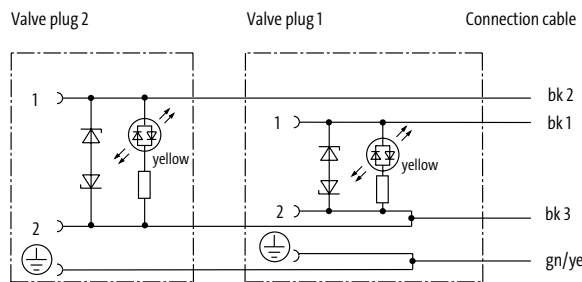
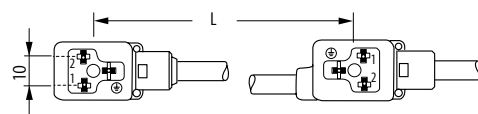
<b>1 Form</b>	<b>58201</b>	<b>58221</b>	<b>58241</b>																																																	
	24 V AC ±20% / DC ±25%	24 V AC ±20% / DC ±25%	24 V AC ±20% / DC ±25%																																																	
	LED and suppression L = 100 mm	LED and suppression L = 150 mm	LED and suppression L = 200 mm																																																	
<b>Circuit diagram</b>																																																				
<b>Contact layout</b>																																																				
<b>2 Cable Type</b>	<table border="1"> <thead> <tr> <th rowspan="2">Wire diameter 0.75 mm<sup>2</sup></th> <th colspan="3">Jacket Color</th> <th colspan="3">Jacket Color</th> <th colspan="3">Jacket Color</th> </tr> <tr> <th>yellow</th> <th>gray</th> <th>black</th> <th>yellow</th> <th>gray</th> <th>black</th> <th>yellow</th> <th>gray</th> <th>black</th> </tr> </thead> <tbody> <tr> <td>PVC</td> <td>017</td> <td>217</td> <td>617</td> <td>017</td> <td>217</td> <td>617</td> <td>017</td> <td>217</td> <td>617</td> </tr> <tr> <td>PUR/PVC (UL/CSA)</td> <td>027</td> <td>227</td> <td>627</td> <td>027</td> <td>227</td> <td>627</td> <td>027</td> <td>227</td> <td>627</td> </tr> <tr> <td>PUR (UL/CSA), robots/Ctracks</td> <td>037</td> <td>237</td> <td>637</td> <td>037</td> <td>237</td> <td>637</td> <td>037</td> <td>237</td> <td>637</td> </tr> </tbody> </table>			Wire diameter 0.75 mm <sup>2</sup>	Jacket Color			Jacket Color			Jacket Color			yellow	gray	black	yellow	gray	black	yellow	gray	black	PVC	017	217	617	017	217	617	017	217	617	PUR/PVC (UL/CSA)	027	227	627	027	227	627	027	227	627	PUR (UL/CSA), robots/Ctracks	037	237	637	037	237	637	037	237	637
Wire diameter 0.75 mm <sup>2</sup>	Jacket Color				Jacket Color			Jacket Color																																												
	yellow	gray	black	yellow	gray	black	yellow	gray	black																																											
PVC	017	217	617	017	217	617	017	217	617																																											
PUR/PVC (UL/CSA)	027	227	627	027	227	627	027	227	627																																											
PUR (UL/CSA), robots/Ctracks	037	237	637	037	237	637	037	237	637																																											
<b>3 Cable Length</b>	<table border="1"> <tbody> <tr> <td>1.5 m</td> <td>0150</td> </tr> <tr> <td>3.0 m</td> <td>0300</td> </tr> <tr> <td>5.0 m</td> <td>0500</td> </tr> <tr> <td>7.5 m</td> <td>0750</td> </tr> <tr> <td>10.0 m</td> <td>1000</td> </tr> </tbody> </table>			1.5 m	0150	3.0 m	0300	5.0 m	0500	7.5 m	0750	10.0 m	1000																																							
1.5 m	0150																																																			
3.0 m	0300																																																			
5.0 m	0500																																																			
7.5 m	0750																																																			
10.0 m	1000																																																			
<b>Technical Data</b>	<table border="1"> <tbody> <tr> <td>Operating voltage</td> <td colspan="3">24 V AC ±20% / DC ±25%</td> </tr> <tr> <td>Protection</td> <td colspan="3">IP67 inserted and tightened (EN 60529)</td> </tr> <tr> <td>Temperature range</td> <td colspan="3">-25...+85 °C, depending on cable quality</td> </tr> </tbody> </table>			Operating voltage	24 V AC ±20% / DC ±25%			Protection	IP67 inserted and tightened (EN 60529)			Temperature range	-25...+85 °C, depending on cable quality																																							
Operating voltage	24 V AC ±20% / DC ±25%																																																			
Protection	IP67 inserted and tightened (EN 60529)																																																			
Temperature range	-25...+85 °C, depending on cable quality																																																			
<b>Article No.</b>	<p>The composition of your article number is explained on page 3.1.i</p> <p style="text-align: center;"><b>7 0 0 0</b> - - - - -</p>																																																			
<b>Notes</b>	<p>Other versions on request. Differing cable lengths up to 2 m can be ordered in 0.2 m steps, from 2 m on in 0.5 m steps.</p>																																																			
	<b>1 Form</b>	<b>2 Cable Type</b>	<b>3 Cable Length</b>																																																	

# VALVE CONNECTORS

MSUD - MSUD

– Double valve plugs with connection cable

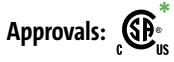

\* only for products with UL/CSA approved cable

Form BI (11 mm)



<b>1 Form</b>	<b>58101</b>	<b>58121</b>	<b>58141</b>							
	Type	24 V AC ±20% / DC ±25%	24 V AC ±20% / DC ±25%	24 V AC ±20% / DC ±25%						
	LED and suppression	LED and suppression	LED and suppression							
	L = 100 mm	L = 150 mm	L = 200 mm							
<b>Circuit diagram</b>										
<b>Contact layout</b>										
<b>2 Cable Type</b>	<b>Jacket Color</b>	<b>Jacket Color</b>								
	Wire diameter 0.75 mm <sup>2</sup>	yellow	gray	black	yellow	gray	black	yellow	gray	black
	PVC	017	217	617	017	217	617	017	217	617
	PUR/PVC (UL/CSA)	027	227	627	027	227	627	027	227	627
PUR (UL/CSA), robots/Ctracks	037	237	637	037	237	637	037	237	637	
<b>3 Cable Length</b>	1.5 m	0150								
	3.0 m	0300								
	5.0 m	0500								
	7.5 m	0750								
	10.0 m	1000								
<b>Technical Data</b>										
Operating voltage	24 V AC ±20% / DC ±25%									
Protection	IP67 inserted and tightened (EN 60529)									
Temperature range	-25...+85 °C, depending on cable quality									
<b>Article No.</b>										
The composition of your article number is explained on page 3.1.i	<div style="display: flex; justify-content: space-around; align-items: center;"> <span style="border-bottom: 1px solid black; padding: 0 5px;">7</span> <span style="border-bottom: 1px solid black; padding: 0 5px;">0</span> <span style="border-bottom: 1px solid black; padding: 0 5px;">0</span> <span style="border-bottom: 1px solid black; padding: 0 5px;">0</span> <span style="font-size: 2em;">-</span> <span style="border-bottom: 1px solid black; padding: 0 5px;"> </span> <span style="font-size: 2em;">-</span> <span style="border-bottom: 1px solid black; padding: 0 5px;"> </span> <span style="border-bottom: 1px solid black; padding: 0 5px;"> </span> <span style="border-bottom: 1px solid black; padding: 0 5px;"> </span> </div>									
	<b>1 Form</b>			<b>2 Cable Type</b>			<b>3 Cable Length</b>			
<b>Notes</b>	Other versions on request. Differing cable lengths up to 2 m can be ordered in 0.2 m steps, from 2 m on in 0.5 m steps.									

Valve Connectors



# VALVE CONNECTORS

MSUD - MSUD

– Double valve plugs with connection cable

Form C (8 mm)



1 Form	58401	58411	58421
Type	24 V AC ±20% / DC ±25%	24 V AC ±20% / DC ±25%	24 V AC ±20% / DC ±25%
LED and suppression	LED and suppression	LED and suppression	LED and suppression
L = 110 mm	L = 110 mm	L = 150 mm	L = 200 mm
Circuit diagram			
Contact layout			
2 Cable Type	Jacket Color	Jacket Color	Jacket Color
Wire diameter 0.75 mm <sup>2</sup>	yellow gray black	yellow gray black	yellow gray black
PVC	017 217 617	017 217 617	017 217 617
PUR/PVC (UL/CSA)	027 217 627	027 217 627	027 217 627
3 Cable Length			
1.5 m	0150		
3.0 m	0300		
5.0 m	0500		
7.5 m	0750		
10.0 m	1000		
Technical Data			
Operating voltage	24 V AC ±20% / DC ±25%		
Protection	IP67 inserted and tightened (EN 60529)		
Temperature range	-25...+85 °C, depending on cable quality		
Article No.			
The composition of your article number is explained on page 3.1.i	<div style="display: flex; justify-content: space-around; align-items: center;"> <span style="border: 1px solid black; padding: 2px 5px;">7</span> <span style="border: 1px solid black; padding: 2px 5px;">0</span> <span style="border: 1px solid black; padding: 2px 5px;">0</span> <span style="border: 1px solid black; padding: 2px 5px;">0</span> <span style="font-size: 2em;">-</span> <span style="border: 1px solid black; padding: 2px 5px;">-</span> <span style="font-size: 2em;">-</span> <span style="border: 1px solid black; padding: 2px 5px;">-</span> <span style="font-size: 2em;">-</span> </div>		
	<b>1</b>	<b>2</b>	<b>3</b>
	Form	Cable Type	Cable Length
Notes	Other versions on request. Differing cable lengths up to 2 m can be ordered in 0.2 m steps, from 2 m on in 0.5 m steps.		

# VALVE CONNECTORS

MSUD - MSUD

– Double valve plugs with connection cable

Form CI (9.4 mm)

Industrial standard



1 Form	58431	58441	58451						
Type	24 V AC ±20% / DC ±25%	24 V AC ±20% / DC ±25%	24 V AC ±20% / DC ±25%						
LED and suppression	LED and suppression	LED and suppression	LED and suppression						
L = 110 mm	L = 150 mm	L = 200 mm							
Circuit diagram									
Contact layout									
2 Cable Type	Jacket Color								
Wire diameter 0.75 mm <sup>2</sup>	yellow	gray	black	yellow	gray	black	yellow	gray	black
PVC	017	217	617	017	217	617	017	217	617
PUR/PVC (UL/CSA)	027		627	027		627	027		627
3 Cable Length									
1.5 m	0150								
3.0 m	0300								
5.0 m	0500								
7.5 m	0750								
10.0 m	1000								
Technical Data									
Operating voltage	24 V AC ±20% / DC ±25%								
Protection	IP67 inserted and tightened (EN 60529)								
Temperature range	-25...+85 °C, depending on cable quality								
Article No.									
The composition of your article number is explained on page 3.1.i	<div style="display: flex; justify-content: space-around; align-items: center;"> <span style="border-bottom: 1px solid black; padding: 0 5px;">7</span> <span style="border-bottom: 1px solid black; padding: 0 5px;">0</span> <span style="border-bottom: 1px solid black; padding: 0 5px;">0</span> <span style="border-bottom: 1px solid black; padding: 0 5px;">0</span> <span style="font-size: 2em;">-</span> <span style="border-bottom: 1px solid black; padding: 0 5px;"> </span> <span style="font-size: 2em;">-</span> <span style="border-bottom: 1px solid black; padding: 0 5px;"> </span> <span style="border-bottom: 1px solid black; padding: 0 5px;"> </span> <span style="border-bottom: 1px solid black; padding: 0 5px;"> </span> </div>								
	<b>1 Form</b>			<b>2 Cable Type</b>			<b>3 Cable Length</b>		
Notes	Other versions on request. Differing cable lengths up to 2 m can be ordered in 0.2 m steps, from 2 m on in 0.5 m steps.								

Valve Connectors

# VALVE CONNECTORS

MSUD - MSUD

– Double valve plugs with M12 male, connector top entry

Form A (18 mm)

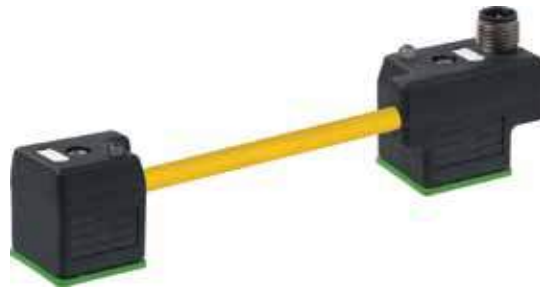

Approvals: 

\* only for products with UL/CSA approved cable

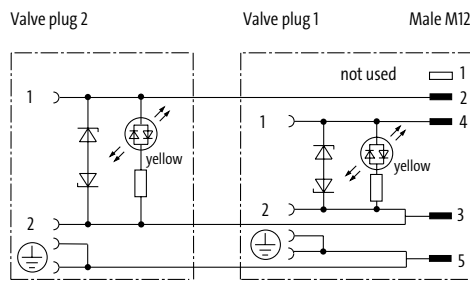
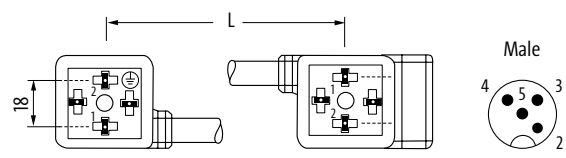
1 Form	41501	41521	41541							
Type	24 V AC ±20% / DC ±25%	24 V AC ±20% / DC ±25%	24 V AC ±20% / DC ±25%							
LED and suppression	LED and suppression	LED and suppression	LED and suppression							
L = 110 mm	L = 150 mm	L = 200 mm								
Circuit diagram										
Contact layout										
2 Cable Type	Jacket Color									
Wire diameter 0.75 mm <sup>2</sup>	yellow	gray	black	yellow	gray	black	yellow	gray	black	
PVC	016	216	616	016	216	616	016	216	616	
PUR/PVC (UL/CSA)	026	226	626	026	226	626	026	226	626	
PUR (UL/CSA), robots/C-tracks	036	236	636	036	236	636	036	236	636	
Technical Data										
Operating voltage	24 V AC ±20% / DC ±25%									
Protection	IP67 inserted and tightened (EN 60529)									
Temperature range	-25...+85 °C, depending on cable quality									
Article No.										
The composition of your article number is explained on page 3.1.i	<u>7 0 0 0</u>			-	-			<u>0 0 0 0</u>		
	<b>1</b> Form			<b>2</b> Cable Type						
Notes	Other versions on request.									

# VALVE CONNECTORS

MSUD - MSUD

– Double valve plugs with M12 male, connector at the rear

Form A (18 mm)



Approvals: 

\* only for products with UL/CSA approved cable

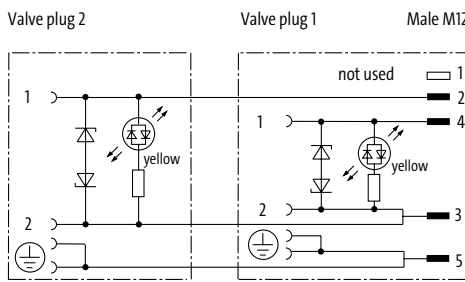
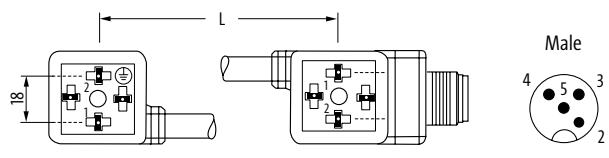
<b>1 Form</b>	<b>41561</b>	<b>41581</b>	<b>41601</b>	
	Type	24 V AC ±20% / DC ±25%	24 V AC ±20% / DC ±25%	24 V AC ±20% / DC ±25%
	LED and suppression	LED and suppression	LED and suppression	
	L = 110 mm	L = 150 mm	L = 200 mm	
<b>Circuit diagram</b>				
<b>Contact layout</b>				
<b>2 Cable Type</b>	<b>Jacket Color</b>	<b>Jacket Color</b>	<b>Jacket Color</b>	
Wire diameter 0.75 mm <sup>2</sup>	yellow    gray    black	yellow    gray    black	yellow    gray    black	
PVC	016    216    616	016    216    616	016    216    616	
PUR/PVC (UL/CSA)	026    226    626	026    226    626	026    226    626	
PUR (UL/CSA), robots/C-tracks	036    236    636	036    236    636	036    236    636	
<b>Technical Data</b>	<p>Operating voltage: 24 V AC ±20% / DC ±25%</p> <p>Protection: IP67 inserted and tightened (EN 60529)</p> <p>Temperature range: -25...+85 °C, depending on cable quality</p>			
<b>Article No.</b>	<p>The composition of your article number is explained on page 3.1.i</p> <p style="text-align: center;"><u>7 0 0 0</u>    -    -    -    -    -    -    -    -    <u>0 0 0 0</u></p>			
	<b>1 Form</b>	<b>2 Cable Type</b>		
<b>Notes</b>	Other versions on request.			

Valve Connectors

# VALVE CONNECTORS

MSUD - M12

– Connection cables

Form A (18 mm)



Male M12

straight

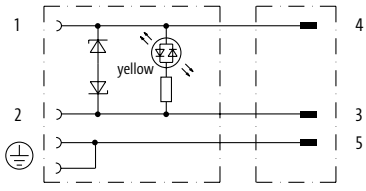
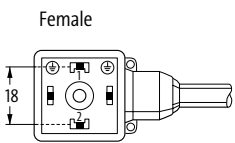

Approvals: 

\* only for products with UL/CSA approved cable

<b>1 Form</b>		<b>40881</b>		
Type	24 V AC ±20% / DC ±25%			
Circuit diagram	<p>LED and suppression</p> 			
Contact layout	 			
<b>2 Cable Type</b>		<b>Jacket Color</b>		
Wire diameter 0.75 mm <sup>2</sup>	<b>yellow</b>	gray	black	
PVC	<b>016</b>	216	616	
PUR/PVC (UL/CSA)	<b>026</b>	226	626	
PUR (UL/CSA), robots/C-tracks	<b>036</b>	236	636	
PUR (UL/CSA), welding spark	<b>056</b>	256	656	
<b>3 Cable Length</b>				
0.3 m	<b>0030</b>			
0.6 m	<b>0060</b>			
1.0 m	<b>0100</b>			
1.5 m	<b>0150</b>			
2.0 m	<b>0200</b>			
<b>Technical Data</b>				
Operating voltage	24 V AC ±20% / DC ±25%			
Protection	IP67 inserted and tightened (EN 60529)			
Temperature range	-25...+85 °C, depending on cable quality			
<b>Article No.</b>				
The composition of your article number is explained on page 3.1.i		<p><b>7 0 0 0</b> - <b>4 0 8 8 1</b> - _____</p>		
		<b>1</b> Form	<b>2</b> Cable Type	<b>3</b> Cable Length
<b>Notes</b>		Other versions on request. Differing cable lengths up to 2 m can be ordered in 0.2 m steps, from 2 m on in 0.5 m steps.		

# VALVE CONNECTORS

MSUD - M12

- Connection cables
- for pressure switches

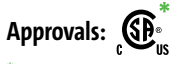

\* only for products with UL/CSA approved cable

Form A (18 mm)

Male M12  
straight



1 Form		40921			40931		
Type	24 V DC ±25%	LED (red/green)			24 V DC ±25%		
Circuit diagram							
Contact layout							
2 Cable Type		Jacket Color			Jacket Color		
Wire diameter 0.34 mm <sup>2</sup>	<b>yellow</b>	gray	black	<b>yellow</b>	gray	black	
PVC (UL/CSA)	015	215 (219)	615 (619)	015	215 (219)	615 (619)	
PUR/PVC (UL/CSA)	025	225	625	025	225	625	
PUR (UL/CSA), robots/C-tracks	035	235	635	035	235	635	
PUR (UL/CSA), welding spark	055	255	655	055	255	655	
3 Cable Length							
0.3 m	0030						
0.6 m	0060						
1.0 m	0100						
1.5 m	0150						
2.0 m	0200						
Technical Data							
Operating voltage	24 V DC ±25%						
Protection	IP67 inserted and tightened (EN 60529)						
Temperature range	-25...+85 °C, depending on cable quality						
Article No.							
The composition of your article number is explained on page 3.1.i	<div style="display: flex; justify-content: space-around; align-items: center;"> <span style="border-bottom: 1px solid black; padding: 0 5px;">7</span> <span style="border-bottom: 1px solid black; padding: 0 5px;">0</span> <span style="border-bottom: 1px solid black; padding: 0 5px;">0</span> <span style="border-bottom: 1px solid black; padding: 0 5px;">0</span> <span style="font-size: 1.5em;">-</span> <span style="border-bottom: 1px solid black; padding: 0 5px;"> </span> <span style="font-size: 1.5em;">-</span> <span style="border-bottom: 1px solid black; padding: 0 5px;"> </span> <span style="border-bottom: 1px solid black; padding: 0 5px;"> </span> </div>						
	<b>1</b>	<b>2</b>	<b>3</b>				
	Form	Cable Type	Cable Length				
Notes		Other versions on request. Differing cable lengths up to 2 m can be ordered in 0.2 m steps, from 2 m on in 0.5 m steps.					

Valve Connectors

# VALVE CONNECTORS

MSUD - M12

– Connection cables

Form B (10 mm)

Male M12  
straight

Form BI (11 mm)

Industrial standard

Male M12  
straight



Approvals: 

\* only for products with UL/CSA approved cable

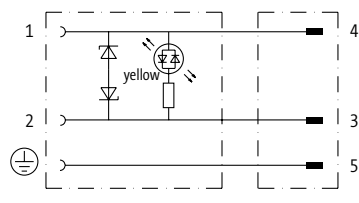
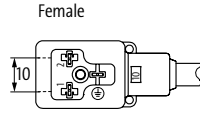
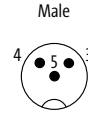
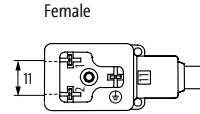
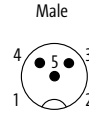
<b>1 Form</b>	<b>41001</b>	<b>40961</b>							
	Type	24 V AC ±20% / DC ±25%			24 V AC ±20% / DC ±25%				
	LED and suppression	LED and suppression			LED and suppression				
Circuit diagram									
Contact layout	<p>Female</p> 			<p>Male</p> 					
	<p>Female</p> 			<p>Male</p> 					
<b>2 Cable Type</b>	<b>Jacket Color</b>	<b>Jacket Color</b>							
Wire diameter 0.75 mm <sup>2</sup>	yellow	gray	black	yellow	gray	black			
PVC	016	216	616	016	216	616			
PUR/PVC (UL/CSA)	026	226	626	026	226	626			
PUR (UL/CSA), robots/C-tracks	036	236	636	036	236	636			
PUR (UL/CSA), welding spark	056	256	656	056	256	656			
<b>3 Cable Length</b>									
0.3 m	0030								
0.6 m	0060								
1.0 m	0100								
1.5 m	0150								
2.0 m	0200								
<b>Technical Data</b>									
Operating voltage	24 V AC ±20% / DC ±25%								
Protection	IP67 inserted and tightened (EN 60529)								
Temperature range	-25...+85 °C, depending on cable quality								
<b>Article No.</b>									
The composition of your article number is explained on page 3.1.i	<div style="display: flex; justify-content: space-around; align-items: center;"> <span style="border: 1px solid black; padding: 2px 5px;">7</span> <span style="border: 1px solid black; padding: 2px 5px;">0</span> <span style="border: 1px solid black; padding: 2px 5px;">0</span> <span style="border: 1px solid black; padding: 2px 5px;">0</span> <span style="font-size: 2em;">-</span> <span style="border: 1px solid black; padding: 2px 5px;">-</span> <span style="font-size: 2em;">-</span> <span style="border: 1px solid black; padding: 2px 5px;">-</span> <span style="font-size: 2em;">-</span> </div>								
	<b>1</b>	<b>Form</b>		<b>2</b>	<b>Cable Type</b>		<b>3</b>	<b>Cable Length</b>	
<b>Notes</b>	Other versions on request. Differing cable lengths up to 2 m can be ordered in 0.2 m steps, from 2 m on in 0.5 m steps.								

# VALVE CONNECTORS

MSUD - M12

– Connection cables

Form C (8 mm)

Male M12  
straight

Form CI (9.4 mm)  
Industrial standard

Male M12  
straight



Approvals: 

\* only for products with UL/CSA approved cable

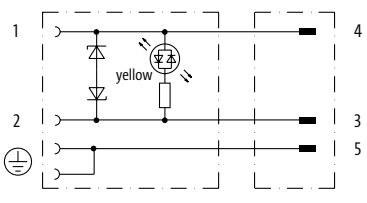
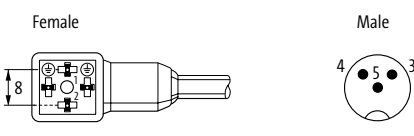
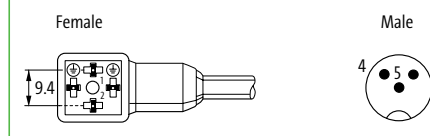
1 Form		41081			41041		
Type		24 V AC ±20% / DC ±25%			24 V AC ±20% / DC ±25%		
		LED and suppression			LED and suppression		
Circuit diagram							
Contact layout							
2 Cable Type		Jacket Color			Jacket Color		
Wire diameter 0.75 mm <sup>2</sup>		yellow	gray	black	yellow	gray	black
PVC		016	216	616	016	216	616
PUR/PVC (UL/CSA)		026	226	626	026	226	626
PUR (UL/CSA), robots/C-tracks		036	236	636	036	236	636
PUR (UL/CSA), welding spark		056	256	656	056	256	656
3 Cable Length							
0.3 m		0030					
0.6 m		0060					
1.0 m		0100					
1.5 m		0150					
2.0 m		0200					
Technical Data							
Operating voltage		24 V AC ±20% / DC ±25%					
Protection		IP67 inserted and tightened (EN 60529)					
Temperature range		-25...+85 °C, depending on cable quality					
Article No.							
The composition of your article number is explained on page 3.1.i		7 0 0 0			- - - - -		
		1 Form		2 Cable Type		3 Cable Length	
Notes		Other versions on request. Differing cable lengths up to 2 m can be ordered in 0.2 m steps, from 2 m on in 0.5 m steps.					



# VALVE CONNECTORS

MSUD - M12

– Adapter

Approvals: 

**Form A (18 mm)**

Top connection



**Form A (18 mm)**

Rear connection

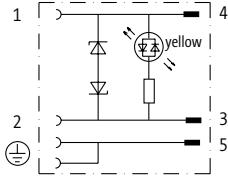
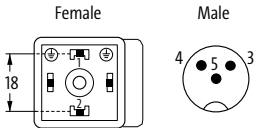
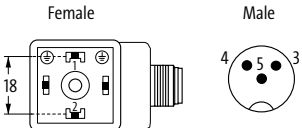

1 Form	41301	41421
Type	24 V AC ±20% / DC ±25% M12, 3-pole LED and suppression	24 V AC ±20% / DC ±25% M12, 3-pole LED and suppression
Circuit diagram		
Contact layout		
<b>Technical Data</b>		
Operating voltage	24 V AC ±20% / DC ±25%	
Rated surge voltage	0.8 kV	
Operating current per contact	max. 4 A	
Configuration	2 contacts + bridged PE	
Locking of ports	M3/M12 × 1 mm (recommended torque 0.4/0.6 Nm)	
Protection	IP67 inserted and tightened (EN 60529)	
Temperature range	-25...+85 °C	
<b>Article No.</b>		
The composition of your article number is explained on page 3.1.i	<p style="text-align: center;"><u>7 0 0 0</u> - <u>      </u> - <u>0 0 0</u> <u>0 0 0 0</u></p>	
	<b>1 Form</b>	
Notes	Other versions on request.	



**VALVE CONNECTORS**

MSUD - M12

- Adapter



**Form B (10 mm)**

Top connection



**Form B (10 mm)**

Rear connection



<b>1 Form</b>	<b>41901</b>	<b>41961</b>
Type	24 V AC ±20% / DC ±25%	24 V AC ±20% / DC ±25%
	M12, 3-pole	M12, 3-pole
	LED and suppression	LED and suppression

Circuit diagram		
Contact layout		

<b>Technical Data</b>		
Operating voltage	24 V AC ±20% / DC ±25%	
Rated surge voltage	0.8 kV	
Operating current per contact	max. 4 A	
Configuration	2 contacts + PE	
Locking of ports	M3/M12 × 1 mm (recommended torque 0.4/0.6 Nm)	
Protection	IP67 inserted and tightened (EN 60529)	
Temperature range	-25...+85 °C	

<b>Article No.</b>		
--------------------	--	--

The composition of your article number is explained on page 3.1.i	<b>7 0 0 0</b>	-	<b>0 0 0</b>	<b>0 0 0 0</b>
	<b>1 Form</b>			

Notes	Other versions on request.
-------	----------------------------



# VALVE CONNECTORS

SVS

- Field-wireable
- Convenient connection, screw terminals

Form A (18 mm)



1 Form	29001	29021	29041	29061
Type	24 V AC ±20% / DC ±25%	24 V AC ±20% / DC ±25%	max. 24 V AC/DC	max. 24 V AC/DC
LED and Z-diode		LED and Z-diode	LED and RC	LED and RC
	metric	PG9	metric	PG9
Circuit diagram				
Contact figure	Cable outlet can be turned in 90° steps			
Contact layout				
<b>Technical Data</b>				
Operating voltage	24 V AC ±20% / DC ±25%		max. 24 V AC/DC	
Operating current per contact	max. 4 A		max. 2 A	
Configuration	2 contacts + PE			
Locking of ports	M3 (recommended torque 0.4 Nm)			
Protection	IP65 inserted and tightened (EN 60529)			
Temperature range	-20...+60 °C			
<b>Article No.</b>				
The composition of your article number is explained on page 3.1.i	<div style="display: flex; justify-content: space-around; align-items: center;"> <span><u>7</u> <u>0</u> <u>0</u> <u>0</u></span> <span>-</span> <span>_____</span> <span>-</span> <span><u>0</u> <u>0</u> <u>0</u></span> <span>  </span> <span><u>0</u> <u>0</u> <u>0</u> <u>0</u></span> </div>			
	<b>1 Form</b>			
Notes	Other versions on request.			

# VALVE CONNECTORS

SVS

- Field-wireable
- Convenient connection, screw terminals

Form A (18 mm)



1 Form	29081	29101	29241	29261
Type	max. 110 V AC/DC	max. 110 V AC/DC	max. 230 V AC/DC	max. 230 V AC/DC
LED and VDR		LED and VDR	without components	without components
	metric	PG9	metric	PG9
Circuit diagram				
Contact figure	Cable outlet can be turned in 90° steps			
Contact layout				
<b>Technical Data</b>				
Operating voltage	max. 110 V AC/DC		max. 230 V AC/DC	
Operating current per contact	max. 1 A		max. 10 A	
Configuration	2 contacts + PE			
Locking of ports	M3 (recommended torque 0.4 Nm)			
Protection	IP65 inserted and tightened (EN 60529)			
Temperature range	-20...+60 °C			
<b>Article No.</b>				
The composition of your article number is explained on page 3.1.i	<u>7</u> <u>0</u> <u>0</u> <u>0</u>	-	<u>0</u> <u>0</u> <u>0</u>	<u>0</u> <u>0</u> <u>0</u> <u>0</u>
	<b>1</b> Form			
Notes	Other versions on request.			

Valve Connectors

# VALVE CONNECTORS

SVS

- Field-wireable
- Convenient connection, screw terminals

Form A (18 mm)



1 Form	29161	29181	29121	29141
Type	max. 230 V AC/DC	max. 230 V AC/DC	110 V AC/DC and 230 V AC/DC	110 V AC/DC and 230 V AC/DC
	LED and VDR	LED and VDR	LED and RC	LED and RC
	metric	PG9	metric	PG9
Circuit diagram				
Contact figure	Cable outlet can be turned in 90° steps			
Contact layout				
<b>Technical Data</b>				
Operating voltage	max. 230 V AC/DC		110 V AC/DC and 230 V AC/DC	
Operating current per contact	max. 1 A			
Configuration	2 contacts + PE			
Locking of ports	M3 (recommended torque 0.4 Nm)			
Protection	IP65 inserted and tightened (EN 60529)			
Temperature range	-20...+60 °C			
<b>Article No.</b>				
The composition of your article number is explained on page 3.1.i	<div style="display: flex; justify-content: space-around; align-items: center;"> <span><u>7</u> <u>0</u> <u>0</u> <u>0</u></span> <span>-</span> <span>_____</span> <span>-</span> <span><u>0</u> <u>0</u> <u>0</u></span> <span>  </span> <span><u>0</u> <u>0</u> <u>0</u> <u>0</u></span> </div>			
	<b>1 Form</b>			
Notes	Other versions on request.			

# VALVE CONNECTORS

SVS

- Field-wireable
- Convenient connection, screw terminals

Form A (18 mm)



1 Form	29481	29501	29521	29541
Type	12...30 V DC	12...30 V DC	24...230 V AC/DC	24...230 V AC/DC
	LED and switching amplifier	LED and switching amplifier	LED and bridge rectifier	LED and bridge rectifier
	metric	PG9	metric	PG9

Circuit diagram

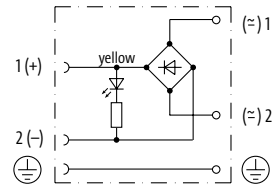
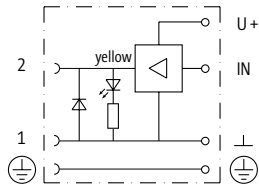

Contact figure

Cable outlet can be turned in 90° steps

Contact layout

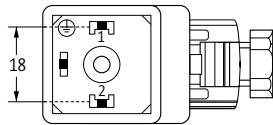

## Technical Data

Operating voltage	12...30 V DC	24...230 V AC/DC
Operating current per contact	max. 2 A (short-circuit protected)	max. 1 A
Configuration	2 contacts + PE	
Locking of ports	M3 (recommended torque 0.4 Nm)	
Protection	IP65 inserted and tightened (EN 60529)	
Temperature range	-20...+60 °C	

## Article No.

The composition of your article number is explained on page 3.1.i

7 0 0 0 - - - - - - - - - - - 0 0 0 0 0 0 0

**1** Form

Notes

Other versions on request.



# VALVE CONNECTORS

SVS

- Field-wireable
- Convenient connection, screw terminals
- for pressure switches

Form A (18 mm)



1 Form	29281	29301	29441	29461
Type	24...230 V AC/DC	24...230 V AC/DC	max. 24 V AC/DC	max. 24 V AC/DC
	LED red (2) green (3)	LED red (2) green (3)	LED green (1) yellow (3)	LED green (1) yellow (3)
	metric	PG9	metric	PG9
Circuit diagram				
Contact figure	Cable outlet can be turned in 90° steps			
Contact layout				
<b>Technical Data</b>				
Operating voltage	24...230 V AC/DC		max. 24 V AC/DC	
Operating current per contact	max. 4 A			
Configuration	3 contacts + PE			
Locking of ports	M3 (recommended torque 0.4 Nm)			
Protection	IP65 inserted and tightened (EN 60529)			
Temperature range	-20...+60 °C			
<b>Article No.</b>				
The composition of your article number is explained on page 3.1.i	<div style="display: flex; justify-content: space-around; align-items: center;"> <span><u>7</u> <u>0</u> <u>0</u> <u>0</u></span> <span>-</span> <span>_____</span> <span>-</span> <span><u>0</u> <u>0</u> <u>0</u></span> <span>  </span> <span><u>0</u> <u>0</u> <u>0</u> <u>0</u></span> </div>			
	<b>1 Form</b>			
Notes	Other versions on request.			

# VALVE CONNECTORS

SVS

- Field-wireable
- Convenient connection, screw terminals
- for pressure switches

Form A (18 mm)



1 Form	29361	29381	29401	29421
Type	24...230 V AC/DC	24...230 V AC/DC	max. 230 V AC/DC	max. 230 V AC/DC
	LED yellow (3)	LED yellow (3)	without components	without components
	metric	PG9	metric	PG9
Circuit diagram				
Contact figure	Cable outlet can be turned in 90° steps			
Contact layout				
<b>Technical Data</b>				
Operating voltage	24...230 V AC/DC		max. 230 V AC/DC	
Operating current per contact	max. 4 A		max. 10 A	
Configuration	3 contacts + PE			
Locking of ports	M3 (recommended torque 0.4 Nm)			
Protection	IP65 inserted and tightened (EN 60529)			
Temperature range	-20...+60 °C			
<b>Article No.</b>				
The composition of your article number is explained on page 3.1.i	<div style="display: flex; justify-content: space-around; align-items: center;"> <span><u>7 0 0 0</u></span> <span>-</span> <span>_____</span> <span>-</span> <span><u>0 0 0</u></span> <span>  </span> <span><u>0 0 0 0</u></span> </div>			
	<b>1 Form</b>			
Notes	Other versions on request.			

Valve Connectors

# VALVE CONNECTORS

SVS

- Field-wireable
- Convenient connection, screw terminals

Form B (10 mm)



1 Form	29561	29581	29601	29621
Type	24 V AC ±20% / DC ±25%	24 V AC ±20% / DC ±25%	max. 24 V AC/DC	max. 24 V AC/DC
LED and Z-diode		LED and Z-diode	LED and RC	LED and RC
	metric	PG9	metric	PG9
Circuit diagram				
Contact figure	Cable outlet can be turned in 180° steps			
Contact layout				
<b>Technical Data</b>				
Operating voltage	24 V AC ±20% / DC ±25%		max. 24 V AC/DC	
Operating current per contact	max. 4 A		max. 2 A	
Configuration	2 contacts + PE			
Locking of ports	M3 (recommended torque 0.4 Nm)			
Protection	IP65 inserted and tightened (EN 60529)			
Temperature range	-20...+60 °C			
<b>Article No.</b>				
The composition of your article number is explained on page 3.1.i	<div style="display: flex; justify-content: space-around; align-items: center;"> <span><u>7</u> <u>0</u> <u>0</u> <u>0</u></span> <span>-</span> <span>_____</span> <span>-</span> <span><u>0</u> <u>0</u> <u>0</u></span> <span>  </span> <span><u>0</u> <u>0</u> <u>0</u> <u>0</u></span> </div>			
	<b>1 Form</b>			
Notes	Other versions on request.			

# VALVE CONNECTORS

SVS

- Field-wireable
- Convenient connection, screw terminals

## Form BI (11 mm)

Industrial standard



1 Form	29801	29821	29841	29861
Type	24 V AC $\pm 20\%$ / DC $\pm 25\%$	24 V AC $\pm 20\%$ / DC $\pm 25\%$	max. 24 V AC/DC	max. 24 V AC/DC
LED and Z-diode		LED and Z-diode	LED and RC	LED and RC
metric		PG9	metric	PG9
Circuit diagram				
Contact figure	Cable outlet can be turned in 180° steps			
Contact layout				
<b>Technical Data</b>				
Operating voltage	24 V AC $\pm 20\%$ / DC $\pm 25\%$		max. 24 V AC/DC	
Operating current per contact	max. 4 A		max. 2 A	
Configuration	2 contacts + PE			
Locking of ports	M3 (recommended torque 0.4 Nm)			
Protection	IP65 inserted and tightened (EN 60529)			
Temperature range	-20...+60 °C			
<b>Article No.</b>				
The composition of your article number is explained on page 3.1.i	<u>7</u> <u>0</u> <u>0</u> <u>0</u>	-	-	<u>0</u> <u>0</u> <u>0</u> <u>0</u>
	<b>1</b> Form			
Notes	Other versions on request.			

# VALVE CONNECTORS

MOSA

– Field-wireable

– IDC terminals

Form C (8 mm)



Form CI (9.4 mm)

Industrial standard



1 Form	80081	94081
Type	24 V AC/DC ±25%	24 V AC/DC ±25%
	LED and suppression	LED and suppression
Circuit diagram		
Contact figure	Cable outlet can be turned in 90° steps	
Contact layout		
<b>Technical Data</b>		
Operating voltage	24 V AC/DC ±25%	
Operating current per contact	max. 3 A	
Configuration	3 contacts + PE	
Contact figure	Cable outlet can be turned in 3 × 90° steps	
Protection	IP65 inserted and tightened (EN 60529)	
Temperature range	-25...+85 °C	
<b>Article No.</b>		
The composition of your article number is explained on page 3.1.i	<span style="border-bottom: 1px solid black; padding: 0 5px;">7</span> <span style="border-bottom: 1px solid black; padding: 0 5px;">0</span> <span style="border-bottom: 1px solid black; padding: 0 5px;">0</span> <span style="border-bottom: 1px solid black; padding: 0 5px;">0</span> <span style="font-size: 1.2em; vertical-align: middle;">-</span> <span style="border-bottom: 1px solid black; padding: 0 5px;"> </span> <span style="border-bottom: 1px solid black; padding: 0 5px;"> </span> <span style="border-bottom: 1px solid black; padding: 0 5px;"> </span> <span style="border-bottom: 1px solid black; padding: 0 5px;"> </span> <span style="font-size: 1.2em; vertical-align: middle;">-</span> <span style="border-bottom: 1px solid black; padding: 0 5px;">0</span> <span style="border-bottom: 1px solid black; padding: 0 5px;">0</span> <span style="border-bottom: 1px solid black; padding: 0 5px;">0</span> <span style="border-bottom: 1px solid black; padding: 0 5px;">0</span>	
	<b>1</b> Form	
Notes	Other versions on request.	

# VALVE CONNECTORS

- SVS Eco
- Field-wireable
- Screw terminals
- without components

Form A (18 mm)



Form A (18 mm)  
for pressure switches



1 Form	29245	29405
Type	max. 250 V AC/DC without components metric	max. 250 V AC/DC without components metric
Circuit diagram		
Contact figure Contact layout	Cable outlet can be turned in 90° steps 	
<b>Technical Data</b>		
Operating voltage	max. 250 V AC/DC	
Operating current per contact	max. 10 A	
Configuration	2 contacts + PE	3 contacts + PE
Locking of ports	M3 (recommended torque 0.4 Nm)	
Contact figure	Cable outlet can be turned in 90° steps	
Protection	IP65 inserted and tightened (EN 60529)	
Temperature range	-40...+90 °C	
<b>Article No.</b>		
The composition of your article number is explained on page 3.1.i	<div style="display: flex; justify-content: space-around; align-items: center;"> <span><u>7 0 0 0</u></span> <span>-</span> <span>_____</span> <span>-</span> <span><u>0 0 0</u></span> <span>  </span> <span><u>0 0 0 0</u></span> </div>	
	<b>1 Form</b>	
Notes	Other versions on request.	

Valve Connectors

# VALVE CONNECTORS

SVS Eco

- Field-wireable
- Screw terminals
- without components

Form B (10 mm)



Form BI (11 mm)



1 Form	29765	30005
Type	max. 250 V AC/DC without components metric	max. 250 V AC/DC without components metric
Circuit diagram		
Contact figure Contact layout	<p>Cable outlet can be turned in 180° steps</p>	
<b>Technical Data</b>		
Operating voltage	max. 250 V AC/DC	
Operating current per contact	max. 10 A	
Configuration	2 contacts + PE	
Locking of ports	M3 (recommended torque 0.4 Nm)	
Contact figure	Cable outlet can be turned in 180° steps	
Protection	IP65 inserted and tightened (EN 60529)	
Temperature range	-40...+90 °C	
<b>Article No.</b>		
The composition of your article number is explained on page 3.1.i	<span style="font-size: 1.2em; font-weight: bold;">7 0 0 0</span> - <span style="font-size: 1.2em; font-weight: bold;">0 0 0</span>   <span style="font-size: 1.2em; font-weight: bold;">0 0 0 0</span>	
	<b>1 Form</b>	
Notes	Other versions on request.	

# VALVE CONNECTORS

- SVS Eco
- Field-wireable
- Screw terminals
- without components

**Form C (8 mm)**



**Form CI (9.4 mm)**

Industrial standard



<b>1 Form</b>	<b>30055</b>	<b>30155</b>	
	Type	max. 250 V AC/DC without components	max. 250 V AC/DC without components
		metric	metric

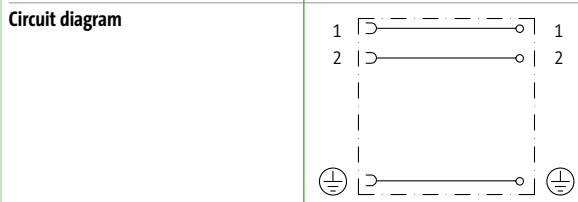

Contact figure  
Contact layout

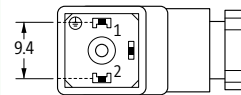
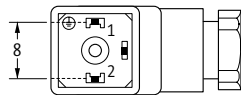

## Technical Data

Operating voltage	max. 250 V AC/DC	
Operating current per contact	max. 6 A	
Configuration	2 contacts + PE	
Locking of ports	M2.5 (recommended torque 0.4 Nm)	M3 (recommended torque 0.4 Nm)
Contact figure	Cable outlet can be turned in 90° steps	
Protection	IP65 inserted and tightened (EN 60529)	
Temperature range	-40...+90 °C	

## Article No.

The composition of your article number is explained on page 3.1.i

7 0 0 0 - - - - - - - - - - 0 0 0 0 0 0 0

**1 Form**

## Notes

Other versions on request.



# VALVE CONNECTORS

SVS Eco, LED

- Field-wireable
- Screw terminals

Form A (18 mm)



1 Form	29005	29085	29165		
Type	24 V AC/DC ±10%	110 V AC/DC ±10%	230 V AC/DC		
	LED and VDR metric	LED and VDR metric	LED and VDR metric		
Circuit diagram					
Contact figure	Cable outlet can be turned in 90° steps				
Contact layout					
<b>Technical Data</b>					
Operating voltage	24 V AC/DC ±10%	110 V AC/DC ±10%	230 V AC/DC ±10%		
Operating current per contact	max. 1.5 A				
Configuration	2 contacts + PE				
Locking of ports	M3 (recommended torque 0.4 Nm)				
Contact figure	Cable outlet can be turned in 90° steps				
Protection	IP65 inserted and tightened (EN 60529)				
Temperature range	-40...+60 °C				
<b>Article No.</b>					
The composition of your article number is explained on page 3.1.i	<u>7</u> <u>0</u> <u>0</u> <u>0</u>	-	-	<u>0</u> <u>0</u> <u>0</u>	<u>0</u> <u>0</u> <u>0</u> <u>0</u>
	<b>1</b> Form				
Notes	Other versions on request.				

# VALVE CONNECTORS

SVS Eco, LED

– Field-wireable

– Screw terminals

Form B (10 mm)



1 Form	29565	29645	29685		
Type	24 V AC/DC ±10%	110 V AC/DC ±10%	230 V AC/DC ±10%		
	LED and VDR	LED and VDR	LED and VDR		
	metric	metric	metric		
Circuit diagram					
Contact figure	Cable outlet can be turned in 180° steps				
Contact layout					
<b>Technical Data</b>					
Operating voltage	24 V AC/DC ±10%	110 V AC/DC ±10%	230 V AC/DC ±10%		
Operating current per contact	max. 1.5 A				
Configuration	2 contacts + PE				
Locking of ports	M3 (recommended torque 0.4 Nm)				
Contact figure	Cable outlet can be turned in 180° steps				
Protection	IP65 inserted and tightened (EN 60529)				
Temperature range	-40...+60 °C				
<b>Article No.</b>					
The composition of your article number is explained on page 3.1.i	<u>7</u> <u>0</u> <u>0</u> <u>0</u>	-	-	<u>0</u> <u>0</u> <u>0</u>	<u>0</u> <u>0</u> <u>0</u> <u>0</u>
	<b>1</b> Form				
Notes	Other versions on request.				

# VALVE CONNECTORS

SVS Eco, LED

– Field-wireable

– Screw terminals

**Form BI (11 mm)**

Industrial standard



1 Form	29805	29885	29925		
Type	24 V AC/DC ±10%	110 V AC/DC ±10%	230 V AC ±10%		
	LED and VDR metric	LED and VDR metric	LED and VDR metric		
Circuit diagram					
Contact figure	Cable outlet can be turned in 180° steps				
Contact layout					
<b>Technical Data</b>					
Operating voltage	24 V AC/DC ±10%	110 V AC/DC ±10%	230 V AC ±10%		
Operating current per contact	max. 1.5 A				
Configuration	2 contacts + PE				
Locking of ports	M3 (recommended torque 0.4 Nm)				
Contact figure	Cable outlet can be turned in 180° steps				
Protection	IP65 inserted and tightened (EN 60529)				
Temperature range	-40...+60 °C				
<b>Article No.</b>					
The composition of your article number is explained on page 3.1.i	<u>7</u> <u>0</u> <u>0</u> <u>0</u>	-	-	<u>0</u> <u>0</u> <u>0</u>	<u>0</u> <u>0</u> <u>0</u> <u>0</u>
	<b>1</b> Form				
Notes	Other versions on request.				

# VALVE CONNECTORS

SVS Eco, LED

- Field-wireable
- Screw terminals

Form C (8 mm)





1 Form	30105	30115	30125		
Type	24 V AC/DC ±10%	110 V AC/DC ±10%	230 V AC/DC ±10%		
	LED and VDR	LED and VDR	LED and VDR		
	metric	metric	metric		
Circuit diagram					
Contact figure	Cable outlet can be turned in 90° steps				
Contact layout					
<b>Technical Data</b>					
Operating voltage	24 V AC/DC ±10%	110 V AC/DC ±10%	230 V AC/DC ±10%		
Operating current per contact	max. 1.5 A				
Configuration	2 contacts + PE				
Locking of ports	M2.5 (recommended torque 0.4 Nm)				
Contact figure	Cable outlet can be turned in 90° steps				
Protection	IP65 inserted and tightened (EN 60529)				
Temperature range	-40...+60 °C				
<b>Article No.</b>					
The composition of your article number is explained on page 3.1.i	<u>7</u> <u>0</u> <u>0</u> <u>0</u>	-	-	<u>0</u> <u>0</u> <u>0</u>	<u>0</u> <u>0</u> <u>0</u> <u>0</u>
	<b>1</b> Form				
Notes	Other versions on request.				

Valve Connectors



## VALVE CONNECTORS

Labeling accessories			Art-No.
	<b>ACS label plate (KM 5)</b>		
	for self marking (9 × 20 mm)		7000-99001-0000000
	for self marking with ADEMARK markers		7000-99003-0000000
Gasket accessories			Art-No.
	Silicon gasket	Valve plug (form A)	7000-99011-0000000
	Flat gasket, NBR	Valve plug (form A)	7000-99012-0000000
	Silicon gasket	Valve plug (form B, BI)	7000-99013-0000000
	Flat gasket, NBR	Valve plug (form B, BI)	7000-99014-0000000
	<b>Accessories set</b>		
	Screw, isolation plate, label plate, flat gasket	Valve plug (form A)	7000-99015-0000000
	Screw, isolation plate, label plate, flat gasket	Valve plug (form A), field wireable	7000-99016-0000000
	Screw, isolation plate, label plate, flat gasket	Valve plug (form B, BI)	7000-99017-0000000
	Screw, isolation plate, label plate, flat gasket	Valve plug (form B, BI), field wireable	7000-99018-0000000
	Screw, isolation plate, label plate, flat gasket	Valve plug (form C)	7000-99019-0000000
	<b>Hexagonal screw</b>		
	Metal	Valve plug (form A)	7000-99021-0000000
	Metal	Valve plug (form A, B, BI), field wireable	7000-99022-0000000
	Stainless Steel 1.4404 (V4A)	Valve plug (form A)	7000-99024-0000000
	Plastic	Valve plug (form A)	7000-99023-0000000
	<b>Gasket for valve plug socket</b>		
	2 contacts + PE and 3 contacts + PE	Valve plug (form A)	7000-99251-0000000
	2 contacts + PE and 3 contacts + PE	Valve plug (form A)	7000-99255-0000000
	FPM		
	2 contacts + PE	Valve plug (form B)	7000-99271-0000000
	2 contacts + PE	Valve plug (form BI)	7000-99261-0000000
2 contacts + PE and 3 contacts + PE	Valve plug (form C)	7000-99291-0000000	
2 contacts + PE and 3 contacts + PE	Valve plug (form CI)	7000-99281-0000000	
End fitting accessories			Art-No.
	<b>Cable compression gland PG 9</b>		
	(gray)	Valve plug (form A, B, BI), field wireable	7000-99025-0000000
	(black)	Valve plug (form A, B, BI), field wireable	7000-99026-0000000

End fitting accessories			Art-No.
	<b>Tube adapter</b> snap-in for corrugated tube (size 13mm)	Cable diameter (4...7 mm)	<b>7000-99081-0000000</b>
	<b>Valve plug socket</b> 2 contacts + PE 2 contacts + PE 2 contacts + PE 2 contacts + PE 2 contacts + PE	Valve plug (form A) Valve plug (form B) Valve plug (form B1) Valve plug (form C) Valve plug (form C1)	<b>7000-99201-0000000</b> <b>7000-99221-0000000</b> <b>7000-99211-0000000</b> <b>7000-99241-0000000</b> <b>7000-99231-0000000</b>
	<b>Valve plug socket</b> 3 contacts + PE 3 contacts + PE 3 contacts + PE	Valve plug (form A) Valve plug (form C) Valve plug (form C1)	<b>7000-99205-0000000</b> <b>7000-99245-0000000</b> <b>7000-99235-0000000</b>

Cables										
yellow	gray	black	No./diameter of wires	Wire isolation	C-track properties	Material (jacket)	Outer Ø	Bend radius (moving)	Temperature range (fixed)	Temperature range (mobile)
010	210	610	3 × 0.25 mm <sup>2</sup>	PVC (br, bl, bk)		PVC (UL/CSA)	4.5 ±5%	10 × outer Ø	-30...+80 °C	-5...+80 °C
011	211	611	4 × 0.25 mm <sup>2</sup>	PVC (br, wh, bl, bk)		PVC (UL/CSA)	4.8 ±5%	10 × outer Ø	-30...+80 °C	-5...+80 °C
013	213	613	3 × 0.34 mm <sup>2</sup>	PVC (br, bl, bk)		PVC (UL/CSA)	4.6 ±5%	10 × outer Ø	-30...+80 °C	-5...+80 °C
014	214	614	4 × 0.34 mm <sup>2</sup>	PVC (br, wh, bl, bk)		PVC (UL/CSA)	5.0 ±5%	10 × outer Ø	-30...+80 °C	-5...+80 °C
015	215	615	5 × 0.34 mm <sup>2</sup>	PVC (br, wh, bl, bk, gnye)		PVC (UL/CSA)	5.2 ±5%	10 × outer Ø	-30...+80 °C	-5...+80 °C
-	219	619	5 × 0.34 mm <sup>2</sup>	PVC (br, wh, bl, bk, gr)		PVC (UL/CSA)	5.2 ±5%	10 × outer Ø	-30...+80 °C	-5...+80 °C
015	215	615	5 × 0.34 mm <sup>2</sup>	PVC (br, wh, bl, bk, gnye)		PVC (UL/CSA)	5.2 ±5%	10 × outer Ø	-30...+80 °C	-5...+80 °C
016	216	616	3 × 0.75 mm <sup>2</sup>	PVC (bk num, gnye)		PVC	5.9 ±5%	10 × outer Ø	-30...+70 °C	-5...+70 °C
017	217	617	4 × 0.75 mm <sup>2</sup>	PVC (bk num, gnye)		PVC	6.5 ±5%	10 × outer Ø	-30...+70 °C	-5...+70 °C
018	218	618	5 × 0.75 mm <sup>2</sup>	PVC (bk num, gnye)		PVC	7.0 ±5%	10 × outer Ø	-30...+70 °C	-5...+70 °C
020	220	620	3 × 0.25 mm <sup>2</sup>	PVC (br, bl, bk)	2 Mio.	PUR/PVC (UL/CSA)	4.5 ±5%	15 × outer Ø	-30...+80 °C	-5...+80 °C
021	221	621	4 × 0.25 mm <sup>2</sup>	PVC (br, wh, bl, bk)	2 Mio.	PUR/PVC (UL/CSA)	4.8 ±5%	15 × outer Ø	-30...+80 °C	-5...+80 °C
023	223	623	3 × 0.34 mm <sup>2</sup>	PVC (br, bl, bk)	2 Mio.	PUR/PVC (UL/CSA)	4.9 ±5%	15 × outer Ø	-30...+80 °C	-5...+80 °C
024	224	624	4 × 0.34 mm <sup>2</sup>	PVC (br, wh, bl, bk)	2 Mio.	PUR/PVC (UL/CSA)	5.2 ±5%	15 × outer Ø	-30...+80 °C	-5...+80 °C
025	225	625	5 × 0.34 mm <sup>2</sup>	PVC (br, wh, bl, bk, gnye)	2 Mio.	PUR/PVC (UL/CSA)	5.9 ±5%	15 × outer Ø	-30...+80 °C	-5...+80 °C
025	225	625	5 × 0.34 mm <sup>2</sup>	PVC (br, wh, bl, bk, gnye)	2 Mio.	PUR/PVC (UL/CSA)	5.9 ±5%	15 × outer Ø	-30...+80 °C	-5...+80 °C
026	226	626	3 × 0.75 mm <sup>2</sup>	PVC (bk num, gnye)	2 Mio.	PUR/PVC (UL/CSA)	5.9 ±5%	15 × outer Ø	-30...+80 °C	-5...+80 °C
027	227	627	4 × 0.75 mm <sup>2</sup>	PVC (bk num, gnye)	2 Mio.	PUR/PVC (UL/CSA)	6.5 ±5%	15 × outer Ø	-30...+80 °C	-5...+80 °C
028	228	628	5 × 0.75 mm <sup>2</sup>	PVC (bk num, gnye)	2 Mio.	PUR/PVC (UL/CSA)	7.0 ±5%	15 × outer Ø	-30...+80 °C	-5...+80 °C
030	230	630	3 × 0.25 mm <sup>2</sup>	PP (br, bl, bk)	5 Mio.	PUR (UL/CSA)	4.3 ±5%	10 × outer Ø	-40...+80 °C	-25...+80 °C
031	231	631	4 × 0.25 mm <sup>2</sup>	PP (br, wh, bl, bk)	5 Mio.	PUR (UL/CSA)	4.7 ±5%	10 × outer Ø	-40...+80 °C	-25...+80 °C
033	233	633	3 × 0.34 mm <sup>2</sup>	PP (br, bl, bk)	5 Mio.	PUR (UL/CSA)	4.3 ±5%	10 × outer Ø	-40...+80 °C	-25...+80 °C
034	234	634	4 × 0.34 mm <sup>2</sup>	PP (br, wh, bl, bk)	5 Mio.	PUR (UL/CSA)	4.7 ±5%	10 × outer Ø	-40...+80 °C	-25...+80 °C
035	235	635	5 × 0.34 mm <sup>2</sup>	PP (br, wh, bl, bk, gnye)	5 Mio.	PUR (UL/CSA)	5.0 ±5%	10 × outer Ø	-40...+80 °C	-25...+80 °C
126	-	732	5 × 0.34 mm <sup>2</sup>	PP (br, wh, bl, bk, gr)	5 Mio.	PUR (UL/CSA)	5.0 ±5%	10 × outer Ø	-40...+80 °C	-25...+80 °C
035	235	635	5 × 0.34 mm <sup>2</sup>	PP (br, wh, bl, bk, gnye)	5 Mio.	PUR (UL/CSA)	5.0 ±5%	10 × outer Ø	-40...+80 °C	-25...+80 °C
036	236	636	3 × 0.75 mm <sup>2</sup>	PP (bk num, gnye)	5 Mio.	PUR (UL/CSA)	5.9 ±5%	10 × outer Ø	-40...+80 °C	-25...+80 °C
037	237	637	4 × 0.75 mm <sup>2</sup>	PP (bk num, gnye)	5 Mio.	PUR (UL/CSA)	6.5 ±5%	10 × outer Ø	-40...+80 °C	-25...+80 °C
038	238	638	5 × 0.75 mm <sup>2</sup>	PP (bk num, gnye)	5 Mio.	PUR (UL/CSA)	7.0 ±5%	10 × outer Ø	-40...+80 °C	-25...+80 °C
050	250	650	3 × 0.25 mm <sup>2</sup>	PP (br, bl, bk)	10 Mio.	PUR (UL/CSA),welding spark	4.3 ±5%	10 × outer Ø	-40...+80 °C	-25...+80 °C
051	251	651	4 × 0.25 mm <sup>2</sup>	PP (br, wh, bl, bk)	10 Mio.	PUR (UL/CSA),welding spark	4.7 ±5%	10 × outer Ø	-40...+80 °C	-25...+80 °C
053	253	653	3 × 0.34 mm <sup>2</sup>	PP (br, bl, bk)	10 Mio.	PUR (UL/CSA),welding spark	4.3 ±5%	10 × outer Ø	-40...+80 °C	-25...+80 °C
054	254	654	4 × 0.34 mm <sup>2</sup>	PP (br, wh, bl, bk)	10 Mio.	PUR (UL/CSA),welding spark	4.7 ±5%	10 × outer Ø	-40...+80 °C	-25...+80 °C
055	255	655	5 × 0.34 mm <sup>2</sup>	PP (br, wh, bl, bk, gnye)	10 Mio.	PUR (UL/CSA),welding spark	5.0 ±5%	10 × outer Ø	-40...+80 °C	-25...+80 °C
055	255	655	5 × 0.34 mm <sup>2</sup>	PP (br, wh, bl, bk, gnye)	10 Mio.	PUR (UL/CSA),welding spark	5.0 ±5%	10 × outer Ø	-40...+80 °C	-25...+80 °C
056	256	656	3 × 0.75 mm <sup>2</sup>	PP (bk num, gnye)	10 Mio.	PUR (UL/CSA),welding spark	5.2 ±5%	10 × outer Ø	-40...+80 °C	-25...+80 °C
114	292	722	8 × 0.25 mm <sup>2</sup>	PP (wh, br, gn, ye, gr, pk, bl, rd)	5 Mio.	PUR (UL/CSA)	6.0 ±5%	10 × outer Ø	-40...+80 °C	-25...+80 °C



# CABLES

## Cables

green	No./diameter of wires	Wire isolation	C-track properties	Material (jacket)	Outer Ø	Bend radius (moving)	Temperature range (fixed)	Temperature range (mobile)
659 shielded	2x2x0.34 mm <sup>2</sup>	PE (wh, ye, bl, or)	2 Mio.	PUR (UL/CSA)	7.4 ±5%	12 × outer Ø	-40...+80 °C	-30...+70 °C
794 shielded	2x2x0.34 mm <sup>2</sup>	PE (wh, ye, bl, or)		PUR (UL/CSA)	6.5 ±5%	12 × outer Ø	-40...+80 °C	-20...+60 °C

green	black	red	No./diameter of wires	Wire isolation	C-track properties	Material (jacket)	Outer Ø	Bend radius (moving)	Temperature range (fixed)	Temperature range (mobile)
478	380	578	4x2x0.14 mm <sup>2</sup>	PE (bkor, or, bkgn, gn, bkbl, bl, bkbr, br)		FRNC	5.9 ±5%	3 × outer-Ø	0...+50 °C	-20...+60 °C
796 shielded	851 shielded	792 shielded	2x2x0.34 mm <sup>2</sup>	PO (wh, ye, bl, or)	3 Mio.	PUR (UL/CSA)	6.7 ±5%	12 × outer Ø	-40...+80 °C	-30...+70 °C

gray	black	No./diameter of wires	Wire isolation	C-track properties	Material (jacket)	Outer Ø	Bend radius (moving)	Temperature range (fixed)	Temperature range (mobile)
200 shielded	600 shielded	3 × 0.34 mm <sup>2</sup>	PVC (br, bl, bk)		PVC (UL/CSA)	5.0 ±5%		-30...+80 °C	-5...+80 °C
201 shielded	601 shielded	4 × 0.34 mm <sup>2</sup>	PVC (br, wh, bl, bk)		PVC (UL/CSA)	5.3 ±5%		-30...+80 °C	-5...+80 °C
202 shielded	602 shielded	5 × 0.34 mm <sup>2</sup>	PVC (br, wh, bl, bk, gnye)		PVC (UL/CSA)	5.6 ±5%		-30...+80 °C	-5...+80 °C
203 shielded	603 shielded	5 × 0.34 mm <sup>2</sup>	PVC (br, wh, bl, bk, gr)		PVC (UL/CSA)	5.6 ±5%		-30...+80 °C	-5...+80 °C
204 shielded	604 shielded	8 × 0.25 mm <sup>2</sup>	PVC (bl, wh, gn, ye, gr, pk, rd, br)		PVC (UL/CSA)	7.0 ±5%		-30...+80 °C	-5...+80 °C
205 shielded	605 shielded	8 × 0.25 mm <sup>2</sup>	PVC (br, wh, bl, bk, gr, pk, vi, or)		PVC (UL/CSA)	7.0 ±5%		-30...+80 °C	-5...+80 °C
206 shielded	706 shielded	12 × 0.14 mm <sup>2</sup>	PP (br, bl, wh, gn, pk, ye, bk, gr, rd, vi, grpk, rdbl)	5 Mio.	PUR (UL/CSA)	6.5 ±5%	10 × outer Ø	-40...+80 °C	-25...+80 °C
207	607	8 × 0.25 mm <sup>2</sup>	PVC (bl, wh, gn, ye, gr, pk, rd, br)		PVC (UL/CSA)	6.0 ±5%	10 × outer Ø	-30...+80 °C	-5...+80 °C
208	608	8 × 0.25 mm <sup>2</sup>	PVC (br, wh, bl, bk, gr, pk, vi, or)		PVC (UL/CSA)	6.0 ±5%	10 × outer Ø	-30...+80 °C	-5...+80 °C
209	609	12 × 0.14 mm <sup>2</sup>	PVC (br, bl, wh, gn, pk, ye, bk, gr, rd, vi, grpk, rdbl)		PVC (UL/CSA)	6.0 ±5%	10 × outer Ø	-30...+80 °C	-5...+80 °C
240 shielded	640 shielded	3 × 0.34 mm <sup>2</sup>	PP (br, bl, bk)	5 Mio.	PUR (UL/CSA)	5.0 ±5%	10 × outer Ø	-40...+80 °C	-25...+80 °C
241 shielded	641 shielded	4 × 0.34 mm <sup>2</sup>	PP (br, wh, bl, bk)	5 Mio.	PUR (UL/CSA)	5.3 ±5%	10 × outer Ø	-40...+80 °C	-25...+80 °C
242 shielded	642 shielded	5 × 0.34 mm <sup>2</sup>	PP (br, wh, bl, bk, gnye)	5 Mio.	PUR (UL/CSA)	5.6 ±5%	10 × outer Ø	-40...+80 °C	-25...+80 °C
243 shielded	643 shielded	5 × 0.34 mm <sup>2</sup>	PP (br, wh, bl, bk, gr)	5 Mio.	PUR (UL/CSA)	5.6 ±5%	10 × outer Ø	-40...+80 °C	-25...+80 °C
291 shielded	717 shielded	8 × 0.25 mm <sup>2</sup>	PP (wh, br, gn, ye, gr, pk, bl, rd)	5 Mio.	PUR (UL/CSA)	7.0 ±5%	10 × outer Ø	-40...+80 °C	-25...+80 °C
294 shielded	715 shielded	8 × 0.25 mm <sup>2</sup>	PP (br, wh, bl, bk, gr, pk, vi, or)	5 Mio.	PUR (UL/CSA)	7.0 ±5%	10 × outer Ø	-40...+80 °C	-25...+80 °C

Cables									
black	violet	No./diameter of wires	Wire isolation	C-track properties	Material (jacket)	Outer Ø	Bend radius (moving)	Temperature range (fixed)	Temperature range (mobile)
838 shielded	803 shielded	2×0.25 + 2×0.34 mm <sup>2</sup>	PE (rd, bk), (bl, wh)		PUR (UL/CSA)	6.9 ±5%	10 × outer Ø	-40...+80 °C	-30...+70 °C
black	green	No./diameter of wires	Wire isolation	C-track properties	Material (jacket)	Outer Ø	Bend radius (moving)	Temperature range (fixed)	Temperature range (mobile)
805	831	4×0.5 + 1×4×0.14 mm <sup>2</sup>	PUR (bl, wh, br, bk, (whor, or)) + (whgn, gn)	5 Mio.	PUR (UL/CSA)	8.1 ±5%	10 × outer Ø	-50...+80 °C	-40...+80 °C
black	yellow	No./diameter of wires	Wire isolation	C-track properties	Material (jacket)	Outer Ø	Bend radius (moving)	Temperature range (fixed)	Temperature range (mobile)
754	145	2 × 0.75 mm <sup>2</sup>	PP (br, bl)	5 Mio.	PUR (UL/CSA)	5.0 ±5%	10 × outer Ø	-40...+80 °C	-25...+80 °C
multi-colored	No./diameter of wires	Wire isolation	C-track properties	Material (jacket)	Outer Ø	Bend radius (moving)	Temperature range (fixed)	Temperature range (mobile)	
901	4 × 0.34 mm <sup>2</sup>	PVC (br, wh, bl, bk)			1.3 ±5%		-40...+105 °C	-5...+105 °C	
902	5 × 0.34 mm <sup>2</sup>	PVC (br, wh, bl, bk, gr)			1.4 ±5%		-40...+105 °C	-5...+105 °C	
903	8 × 0.25 mm <sup>2</sup>	PVC (bl, wh, gn, ye, gr, pk, rd, br)			1.15 ±5%		-40...+105 °C	-5...+105 °C	
910	3 × 0.25 mm <sup>2</sup>	PVC (br, bl, bk)			1.15 ±5%		-40...+105 °C	-5...+105 °C	
911	4 × 0.25 mm <sup>2</sup>	PVC (br, wh, bl, bk)			2.0 ±5%		-40...+105 °C	-5...+105 °C	
940	4 × 1.5 mm <sup>2</sup>	PPE (bk num, gnye)					-40...+85 °C		
941	4 × 1.5 mm <sup>2</sup>	PVC (br, wh, bl, bk)					-40...+85 °C		
969	4 × 0.25 mm <sup>2</sup>	PP (br, bk, bl, wh)			1.1 ±5%		-40...+90 °C	-25...+90 °C	
970	3 × 0.25 mm <sup>2</sup>	PP (br, bk, bl)			1.1 ±5%		-40...+90 °C	-25...+90 °C	
971	4 × 0.34 mm <sup>2</sup>	PP (br, wh, bl, bk)			1.3 ±5%		-40...+90 °C	-25...+90 °C	
973	8 × 0.25 mm <sup>2</sup>	PUR (wh, br, gn, ye, gr, pk, bl, rd)			1.25 ±5%		-40...+90 °C	-25...+90 °C	
975	5 × 0.34 mm <sup>2</sup>	PUR (br, wh, bl, bk, gnye)			1.3 ±5%		-40...+90 °C	-25...+90 °C	
972	5 × 0.34 mm <sup>2</sup>	PUR (br, wh, bl, bk, gr)			1.3 ±5%		-40...+90 °C	-25...+90 °C	
978	5 × 0.75 mm <sup>2</sup>	PVC (br, wh, bl, bk, gnye)			3.1 ±5%		-25...+85 °C	-10...+50 °C	
980	5 × 1.5 mm <sup>2</sup>	PUR (br, wh, bl, bk, gr)			2.4 ±5%		-40...+90 °C	-25...+90 °C	
P80	6 × 2.5 mm <sup>2</sup>	PVC (bk, bl, num, gnye)			3.7 ±5%		-40...+70 °C		
P81	4 × 1.5 mm <sup>2</sup>	PVC (bk num, gnye)			3.1 ±5%		-40...+70 °C		
P82	4 × 2.5 mm <sup>2</sup>	PVC (bk num, gnye)			3.7 ±5%		-40...+70 °C		
gray	No./diameter of wires	Wire isolation	C-track properties	Material (jacket)	Outer Ø	Bend radius (moving)	Temperature range (fixed)	Temperature range (mobile)	
202 shielded	5 × 0.34 mm <sup>2</sup>	PVC (br, wh, bl, bk, gnye)		PVC (UL/CSA)	5.6 ±5%		-30...+80 °C	-5...+80 °C	
203 shielded	5 × 0.34 mm <sup>2</sup>	PVC (br, wh, bl, bk, gr)		PVC (UL/CSA)	5.6 ±5%		-30...+80 °C	-5...+80 °C	
215	5 × 0.34 mm <sup>2</sup>	PVC (br, wh, bl, bk, gnye)		PVC (UL/CSA)	5.2 ±5%	10 × outer Ø	-30...+80 °C	-5...+80 °C	
295	8 × 0.25 mm <sup>2</sup>	PP (br, wh, bl, bk, gr, pk, vi, or)	5 Mio.	PUR (UL/CSA)	6.0 ±5%	10 × outer Ø	-40...+80 °C	-25...+80 °C	

# CABLES

Cables								
gray	No./diameter of wires	Wire isolation	C-track properties	Material (jacket)	Outer Ø	Bend radius (moving)	Temperature range (fixed)	Temperature range (mobile)
301	12 × 0.25 mm <sup>2</sup>	PP (br, bl, wh, gn, pk, ye, bk, gr, rd, vi, grpk, rdbl)	3 Mio.	PUR (UL/CSA)	6.9 ±5%	15 × outer Ø	-40...+80 °C	-20...+80 °C
302	12 × 0.25 mm <sup>2</sup>	PP (br, bl, wh, gn, pk, ye, bk, gr, rd, vi, grpk, rdbl)	5 Mio.	PUR (UL/CSA),welding spark	6.9 ±5%	10 × outer Ø	-40...+80 °C	-25...+80 °C
336	4 × 0.34 mm <sup>2</sup>	TPE-S (br, wh, bl, bk)		TPE-S	5.2 ±5%	15 × outer Ø	-50...+125 °C	-30...+105 °C
414	2 × 0.5 mm <sup>2</sup>	PP (br, bl)	5 Mio.	PUR (UL/CSA)	4.4 ±5%	10 × outer Ø	-40...+80 °C	-25...+80 °C
588	2 × 1.5 mm <sup>2</sup>	PP (br, bl)	5 Mio.	PUR (UL/CSA)	8.0 ±5%	15 × outer Ø	-50...+80 °C	-25...+80 °C
777	2×2×AWG26	FRNC (wh, bl, wh, or)		FRNC	5.0 ±5%	10 × outer Ø	0...+50 °C	-20...+60 °C
862	4 × 0.75 mm <sup>2</sup>	PP (br, wh, bl, bk)	5 Mio.	PUR (UL/CSA)	6.5 ±5%	10 × outer Ø	-40...+80 °C	-25...+80 °C
961	5 × 1.5 mm <sup>2</sup>	PP (br, wh, bl, bk, gnye)	5 Mio.	PUR (UL/CSA)	8.7 ±5%	10 × outer Ø	-50...+80 °C	-20...+80 °C
962	5 × 2.5 mm <sup>2</sup>	PP (br, wh, bl, bk num, gnye)	5 Mio.	PUR (UL/CSA)	9.7 ±5%	10 × outer Ø	-50...+80 °C	-20...+80 °C
965	5 × 1.0 mm <sup>2</sup>	PP (br, wh, bl, bk num, gnye)		PUR/PVC	7.2 ±5%	10 × outer Ø	-30...+70 °C	-5...+70 °C
966	5 × 1.5 mm <sup>2</sup>	PP (br, wh, bl, bk, gr)		PUR/PVC	8.7 ±5%	10 × outer Ø	-30...+70 °C	-5...+70 °C

yellow	No./diameter of wires	Wire isolation	C-track properties	Material (jacket)	Outer Ø	Bend radius (moving)	Temperature range (fixed)	Temperature range (mobile)
150	4 × 0.75 mm <sup>2</sup>	PVC (br, wh, bl, bk)	10 Mio.	TPE (UL/CSA)	7.2 ±5%	15 × outer Ø	-40...+105 °C	-20...+90 °C
161	5 × 0.75 mm <sup>2</sup>	PVC (br, wh, bl, bk, gnye)	10 Mio.	TPE (UL/CSA)	7.7 ±5%	15 × outer Ø	-40...+105 °C	-20...+90 °C
162	5 × 0.75 mm <sup>2</sup>	PVC (br, wh, bl, bk, gr)	10 Mio.	TPE (UL/CSA)	7.7 ±5%	15 × outer Ø	-40...+105 °C	-20...+90 °C
U1B	3 × 1.5 mm <sup>2</sup>	PVC (bk, gn, wh)		TPE (UL/CSA)	8.4 ±5%	10 × outer Ø	-50...+105 °C	-20...+90 °C
U1C	4 × 1.5 mm <sup>2</sup>	PVC (bk, gn, rd, wh)		TPE (UL/CSA)	9.0 ±5%	10 × outer Ø	-50...+105 °C	-20...+90 °C
U1D	5 × 1.5 mm <sup>2</sup>	PVC (bk, or, gn, rd, wh)		TPE (UL/CSA)	9.8 ±5%	10 × outer Ø	-50...+105 °C	-20...+90 °C

green	No./diameter of wires	Wire isolation	C-track properties	Material (jacket)	Outer Ø	Bend radius (moving)	Temperature range (fixed)	Temperature range (mobile)
659 shielded	2×2×0.34 mm <sup>2</sup>	PE (wh, ye, bl, or)	2 Mio.	PUR (UL/CSA)	7.4 ±5%	12 × outer Ø	-40...+80 °C	-30...+70 °C
790 shielded	4×2×0.14 mm <sup>2</sup>	PE (whbl, bl, whor, or, whgn, gn, whbr, br)		PUR (UL/CSA)	6.4 ±5%	12 × outer Ø	-30...+80 °C	-10...+50 °C
791 shielded	1×4×0.15 mm <sup>2</sup>	PO (wh, ye, bl, or)	5 Mio.	PUR (UL/CSA)	4.9 ±5%	12 × outer Ø	-20...+80 °C	-20...+50 °C
793 shielded	1×4×0.34 mm <sup>2</sup>	PE (wh, ye, bl, or)		PUR (UL/CSA)	6.6 ±5%	12 × outer Ø	-40...+80 °C	-20...+60 °C
794 shielded	2×2×0.34 mm <sup>2</sup>	PE (wh, ye, bl, or)		PUR (UL/CSA)	6.5 ±5%	12 × outer Ø	-40...+80 °C	-20...+60 °C
800 shielded	2×2×0.34 mm <sup>2</sup>	PE (wh, ye, bl, or)	2 Mio.	PVC (UL/CSA)	6.5 ±5%	15 × outer Ø	-30...+80 °C	-10...+70 °C
802 shielded	4×0.5 + 2×0.25 mm <sup>2</sup>	TPE (bl, wh, br, bk), (gr, pk)	5 Mio.	PUR (UL/CSA)	7.9 ±5%	10 × outer Ø	-50...+80 °C	-40...+80 °C
57V shielded	2×2×0.34 mm <sup>2</sup>	HDPE (wh, ye, bl, or)	1 Mio.	TPE (UL)	7.9 ±5%	10 × outer Ø	-40...+80 °C	-20...+80 °C

Cables								
violet	No./diameter of wires	Wire isolation	C-track properties	Material (jacket)	Outer Ø	Bend radius (moving)	Temperature range (fixed)	Temperature range (mobile)
<b>840 shielded</b>	1×2×0.25 mm <sup>2</sup>	PE (rd, gn)	5 Mio.	PUR (UL/CSA)	7.8 ±5%	12 × outer Ø	-40...+80 °C	-20...+60 °C
<b>841 shielded</b>	1×2×0.25 mm <sup>2</sup>	PE (rd, gn)	5 Mio.	PUR (UL/CSA)	7.7 ±5%	12 × outer Ø	-40...+80 °C	-20...+60 °C
<b>843 shielded</b>	1×2×0.25 mm <sup>2</sup>	PE (rd, gn)		PUR (UL/CSA)	8.0 ±5%	12 × outer Ø	-40...+80 °C	-20...+50 °C
<b>850 shielded</b>	1×2×0.25 mm <sup>2</sup>	PE (rd, gn)	2 Mio.	PVC (UL)	7.8 ±5%	12 × outer Ø	-25...+70 °C	-20...+60 °C

black	No./diameter of wires	Wire isolation	C-track properties	Material (jacket)	Outer Ø	Bend radius (moving)	Temperature range (fixed)	Temperature range (mobile)
<b>512</b>	2 × 0.75 mm <sup>2</sup>	PP (br, bl)	4 Mio.	PUR (UL)	5.0 ±5%	10 × outer Ø	-40...+80 °C	-25...+80 °C
<b>513</b>	3 × 0.75 mm <sup>2</sup>	PP (br, bl, bk)	4 Mio.	PUR (UL)	5.3 ±5%	10 × outer Ø	-40...+80 °C	-25...+80 °C
<b>514</b>	4 × 0.75 mm <sup>2</sup>	PP (br, wh, bl, bk)	2 Mio.	PUR (UL)	5.7 ±5%	6 × outer Ø		-25...+80 °C
<b>516</b>	6 × 0.75 mm <sup>2</sup>	PP (br, gn, ye, gr, pk, wh)	4 Mio.	PUR (UL)	6.9 ±5%	12 × outer Ø	-40...+80 °C	-25...+80 °C
<b>564</b>	3 × 0.75 mm <sup>2</sup>	PP (br, bl, bk)	5 Mio.	PUR (UL/CSA)	5.9 ±5%	10 × outer Ø	-40...+80 °C	-25...+80 °C
<b>569</b>	4 × 0.75 mm <sup>2</sup>	PP (br, wh, bl, bk)	5 Mio.	PUR (UL/CSA)	6.5 ±5%	10 × outer Ø	-40...+80 °C	-25...+80 °C
<b>572</b>	6 × 0.75 mm <sup>2</sup>	PP (br, wh, bl, bk, gr, pk)	5 Mio.	PUR (UL/CSA)	7.3 ±5%	10 × outer Ø	-40...+80 °C	-25...+80 °C
<b>634</b>	4 × 0.34 mm <sup>2</sup>	PP (br, wh, bl, bk)	5 Mio.	PUR (UL/CSA)	4.7 ±5%	10 × outer Ø	-40...+80 °C	-25...+80 °C
<b>703 shielded</b>	12 × 0.14 mm <sup>2</sup>	PVC (br, bl, wh, gn, pk, ye, bk, gr, rd, vi, grp, rdbl)		PVC (UL/CSA)	6.5 ±5%	10 × outer Ø	-30...+80 °C	-5...+80 °C
<b>705</b>	12 × 0.14 mm <sup>2</sup>	PP (br, bl, wh, gn, pk, ye, bk, gr, rd, vi, grp, rdbl)	2 Mio.	PUR (UL/CSA)	6.0 ±5%	10 × outer Ø	-40...+85 °C	-25...+85 °C
<b>740</b>	2 × 0.5 mm <sup>2</sup>	TPE (bk, wh)	2 Mio.	PUR	5.0 ±5%	10 × outer Ø	-50...+90 °C	-30...+90 °C
<b>750</b>	2 × 0.75 mm <sup>2</sup>	PVC (br, bl)		PUR/PVC	5.9 ±5%	15 × outer Ø	-40...+80 °C	-5...+80 °C
<b>P01</b>	6 × 2.5 mm <sup>2</sup>	TPM (bk num, gnye)	5 Mio.	PUR (UL)	11.1 ±5%	10 × outer Ø	-40...+80 °C	-20...+60 °C
<b>P02</b>	4 × 1.5 mm <sup>2</sup>	TPM (bk num, gnye)	5 Mio.	PUR (UL)	7.4 ±5%	10 × outer Ø	-50...+80 °C	-20...+70 °C
<b>P03</b>	4 × 2.5 mm <sup>2</sup>	TPM (bk num, gnye)	5 Mio.	PUR (UL)	9.0 ±5%	10 × outer Ø	-50...+80 °C	-20...+70 °C
<b>P04</b>	5 × 1.5 mm <sup>2</sup>	PP (br, wh, bl, bk, gr, num)	5 Mio.	PUR (UL/CSA)	8.7 ±5%	10 × outer Ø	-50...+80 °C	-20...+80 °C
<b>P05</b>	5 × 1.5 mm <sup>2</sup>	PP (br, wh, bl, bk num, gnye)	5 Mio.	PUR (UL/CSA)	8.7 ±5%	10 × outer Ø	-50...+80 °C	-20...+80 °C
<b>P06</b>	4 × 1.5 mm <sup>2</sup>	PP (br, wh, bl, num; gnye longitudinally striped)	5 Mio.	PUR (UL/CSA)	7.7 ±5%	10 × outer Ø	-50...+80 °C	-20...+80 °C
<b>P07</b>	4 × 1.5 mm <sup>2</sup>	PP (br, wh, bl, bk, num)	5 Mio.	PUR (UL/CSA)	7.7 ±5%	10 × outer Ø	-50...+80 °C	-20...+80 °C
<b>P21</b>	6 × 2.5 mm <sup>2</sup>	PP (bk num, gnye)		PVC (UL)	11.0 ±5%	15 × outer Ø	-20...+80 °C	-5...+80 °C
<b>P22</b>	4 × 1.5 mm <sup>2</sup>	PP (bk num, gnye)		PVC (UL)	7.4 ±5%	15 × outer Ø	-20...+80 °C	-5...+80 °C
<b>P23</b>	4 × 2.5 mm <sup>2</sup>	PP (bk num, gnye)		PVC (UL)	9.1 ±5%	15 × outer Ø	-20...+80 °C	-5...+80 °C
<b>P24</b>	6 × 1.5 mm <sup>2</sup>	PP (bk num, gnye)		PVC (UL)	9.0 ±5%	15 × outer Ø	-20...+80 °C	-5...+80 °C
<b>P84</b>	6 × 1.5 mm <sup>2</sup>	TPM (bk num, gnye)	5 Mio.	PUR (UL)	9.0 ±5%	6.8 × outer-Ø	-50...+80 °C	-20...+70 °C
<b>UMB</b>	3 × 1.5 mm <sup>2</sup>	TPM (br, bl, gnye)	5 Mio.	PUR (UL/CSA)	7.4 ±5%	10 × outer Ø	-40...+80 °C	-20...+80 °C
<b>UMC</b>	4 × 1.5 mm <sup>2</sup>	TPM (br, wh, bl, bk)	5 Mio.	PUR (UL/CSA)	8.0 ±5%	10 × outer Ø	-50...+80 °C	-20...+80 °C
<b>UMD</b>	5 × 1.5 mm <sup>2</sup>	TPM (br, wh, bl, bk, gnye)	5 Mio.	PUR (UL/CSA)	8.7 ±5%	10 × outer Ø	-50...+80 °C	-20...+80 °C

# CABLES

Cables								
orange	No./diameter of wires	Wire isolation	C-track properties	Material (jacket)	Outer Ø	Bend radius (moving)	Temperature range (fixed)	Temperature range (mobile)
P11 shielded	4x2.5 + 2x1.5 mm <sup>2</sup>	TPM (bk num, gnye)	5 Mio.	PUR (UL)	12.8 ±5%	10 × outer Ø	-25...+80 °C	-20...+80 °C
P12 shielded	4 × 1.5 mm <sup>2</sup>	TPM (bk num, gnye)	5 Mio.	PUR (UL)	8.0 ±5%	10 × outer Ø	-40...+80 °C	-20...+60 °C
P13 shielded	4 × 2.5 mm <sup>2</sup>	TPM (bk num, gnye)	5 Mio.	PUR (UL)	10.6 ±5%	7.5 × outer Ø	-50...+80 °C	-35...+70 °C
pastel blue	No./diameter of wires	Wire isolation	C-track properties	Material (jacket)	Outer Ø	Bend radius (moving)	Temperature range (fixed)	Temperature range (mobile)
315	3 × 0.34 mm <sup>2</sup>	PP (br, bl, bk)	4 Mio.	TPE-S (UL)	4.3 ±5%	10 × outer Ø	-40...+105 °C	-25...+105 °C
321	4 × 0.34 mm <sup>2</sup>	PP (br, wh, bl, bk)	4 Mio.	TPE-S	4.7 ±5%	10 × outer Ø	-40...+105 °C	-25...+105 °C
339	5 × 0.34 mm <sup>2</sup>	PP (br, wh, bl, bk, gnye)	4 Mio.	TPE (UL)	5.0 ±5%	10 × outer Ø	-40...+105 °C	-25...+105 °C
blue	No./diameter of wires	Wire isolation	C-track properties	Material (jacket)	Outer Ø	Bend radius (moving)	Temperature range (fixed)	Temperature range (mobile)
S4U shielded	2x2x0.25 mm <sup>2</sup>	HDPE (whor, or, whgn, gn)	1 Mio.	TPE (UL/CSA)	6.6 ±5%	10 × outer Ø	-40...+80 °C	-20...+80 °C
S4W shielded	4x2x0.25 mm <sup>2</sup>	HDPE (whbl, bl, whor, or, whgn, gn, whbr, br)	1 Mio.	TPE (UL/CSA)	7.6 ±5%	10 × outer Ø	-40...+80 °C	-20...+80 °C
S4X shielded	4x2x0.14 mm <sup>2</sup>	HDPE (whbl, bl, whor, or, whgn, gn, whbr, br)	1 Mio.	TPE (UL/CSA)	7.4 ±5%	10 × outer Ø	-40...+80 °C	-20...+80 °C
gray	No./diameter of wires	C-track properties	Material (jacket)	Outer Ø	Bend radius (moving)	Temperature range (fixed)	Temperature range (mobile)	
333	4x0.34 + 3x0.75 mm <sup>2</sup>	2 Mio.	PUR/PVC	7.4 ±5%	12 × outer Ø	-30...+80 °C	-5...+80 °C	
334	4x0.34 + 2x0.75 mm <sup>2</sup>	5 Mio.	PUR (UL/CSA)	7.6 ±5%	10 × outer Ø	-40...+80 °C	-5...+60 °C	
337	4x0.34 + 2x0.75 mm <sup>2</sup>	2 Mio.	PUR/PVC	6.9 ±5%	10 × outer Ø	-30...+80 °C	-5...+60 °C	
350	6x0.34 + 2x0.75 mm <sup>2</sup>	2 Mio.	PUR/PVC	7.8 ±5%	10 × outer Ø	-30...+80 °C	-5...+60 °C	
356	6x0.34 + 2x0.75 mm <sup>2</sup>	5 Mio.	PUR (UL/CSA)	8.5 ±5%	10 × outer Ø	-40...+80 °C	-5...+60 °C	
357	8x0.34 + 2x0.75 mm <sup>2</sup>	2 Mio.	PUR/PVC	8.6 ±5%	10 × outer Ø	-30...+80 °C	-5...+60 °C	
358	8x0.34 + 2x0.75 mm <sup>2</sup>	1.5 Mio.	PUR/PVC	8.6 ±5%	12 × outer Ø	-30...+70 °C	-5...+60 °C	
359	8x0.34 + 2x0.75 mm <sup>2</sup>	5 Mio.	PUR (UL/CSA)	9.2 ±5%	10 × outer Ø	-40...+80 °C	-5...+60 °C	
360	8x0.34 + 2x0.75 mm <sup>2</sup>	5 Mio.	PUR (UL/CSA)	9.2 ±5%	10 × outer Ø	-40...+80 °C	-5...+60 °C	
362	8x0.34 + 3x0.75 mm <sup>2</sup>	2 Mio.	PUR/PVC (UL/CSA)	8.1 ±5%	10 × outer Ø	-30...+80 °C	-5...+70 °C	
363	8x0.34 + 3x0.75 mm <sup>2</sup>	2 Mio.	PUR/PVC (UL/CSA)	8.1 ±5%	10 × outer Ø	-30...+80 °C	-5...+70 °C	
373 shielded	8x0.34 + 3x0.75 mm <sup>2</sup>	5 Mio.	PUR (UL/CSA)	9.3 ±5%	12 × outer Ø	-40...+90 °C	-40...+90 °C	
374	8x0.34 + 5x0.75 mm <sup>2</sup>	1.5 Mio.	PUR/PVC	9.2 ±5%	12 × outer Ø	-30...+80 °C	-30...+80 °C	
384	10x0.34 + 2x0.75 mm <sup>2</sup>	5 Mio.	PUR (UL/CSA)	9.3 ±5%	10 × outer Ø	-40...+80 °C	-5...+60 °C	
385	10x0.34 + 2x0.75 mm <sup>2</sup>	2 Mio.	PUR/PVC	8.3 ±5%	10 × outer Ø	-30...+80 °C	-5...+60 °C	
386	12x0.34 + 2x0.75 mm <sup>2</sup>	1.5 Mio.	PUR/PVC	8.8 ±5%	12 × outer Ø	-30...+70 °C	-5...+60 °C	
389	12x0.34 + 2x0.75 mm <sup>2</sup>	5 Mio.	PUR (UL/CSA)	9.5 ±5%	10 × outer Ø	-40...+80 °C	-5...+60 °C	
395	16x0.34 + 2x0.75 mm <sup>2</sup>	1.5 Mio.	PUR/PVC	9.6 ±5%	12 × outer Ø	-30...+70 °C	-5...+60 °C	
396	16x0.34 + 2x0.75 mm <sup>2</sup>	5 Mio.	PUR (UL/CSA)	10.4 ±5%	10 × outer Ø	-40...+80 °C	-5...+60 °C	
398	16x0.34 + 3x0.75 mm <sup>2</sup>	2 Mio.	PUR/PVC (UL/CSA)	10.0 ±5%	10 × outer Ø	-30...+80 °C	-5...+70 °C	
401 shielded	16x0.34 + 3x0.75 mm <sup>2</sup>	5 Mio.	PUR (UL/CSA)	11.7 ±5%	12 × outer Ø	-40...+90 °C	-40...+90 °C	
403	16x0.34 + 5x0.75 mm <sup>2</sup>	5 Mio.	PUR (UL/CSA)	11.5 ±5%	10 × outer Ø	-40...+90 °C	-40...+90 °C	
404	16x0.34 + 5x0.75 mm <sup>2</sup>	1.5 Mio.	PUR/PVC	12.5 ±5%	12 × outer Ø	-30...+80 °C	-30...+80 °C	
407	20x0.34 + 3x0.75 mm <sup>2</sup>	2 Mio.	PUR/PVC (UL/CSA)	10.0 ±5%	12 × outer Ø	-30...+80 °C	-5...+60 °C	
408	20x0.34 + 3x0.75 mm <sup>2</sup>	5 Mio.	PUR (UL/CSA)	10.4 ±5%	10 × outer Ø	-40...+80 °C	-5...+80 °C	
411	20x0.34 + 2x0.75 mm <sup>2</sup>	5 Mio.	PUR (UL/CSA)	11.3 ±5%	10 × outer Ø	-40...+80 °C	-5...+60 °C	
412	20x0.34 + 2x0.75 mm <sup>2</sup>	1.5 Mio.	PUR/PVC	10.4 ±5%	12 × outer Ø	-30...+70 °C	-5...+60 °C	
447	8x0.5 + 3x1.0 mm <sup>2</sup>	5 Mio.	PUR (UL/CSA)	9.4 ±5%	10 × outer Ø	-40...+80 °C	-5...+80 °C	
448	8x0.5 + 3x1.0 mm <sup>2</sup>	5 Mio.	PUR (UL/CSA)	9.1 ±5%	10 × outer Ø	-40...+90 °C	-40...+90 °C	
452	16x0.5 + 3x1.0 mm <sup>2</sup>	5 Mio.	PUR (UL/CSA)	11.5 ±5%	10 × outer Ø	-40...+80 °C	-5...+80 °C	



4

# I/O SYSTEMS

4

I/O SYSTEMS

Cube67	4.1
Cube20	4.2
Cube20S	4.3
MVK Metal	4.4
SOLID67	4.5
Impact67	4.6
IO-Link Devices	4.7
MASI Control Cabinet	4.8
MASI Field Installation	4.9
MASI Installation Technology	4.10
M8 Distribution Systems	4.11
M12 Distribution Systems (Metal)	4.12
M12 Distribution Systems (Plastic)	4.13



# CUBE67 MODULAR I/O STATION IP67

- Distributed
- Flexible
- Open system

## THE COMPACT MODULAR I/O SYSTEM

Cube is a modular field bus system for perfect distributed installation concepts. Its flexibility facilitates developing the perfect solution for any application – with consistent degrees of protection from IP20 to IP69K.

Cube's characteristics are: great functionality, plug-in connections, a robust and compact design, encapsulated modules, and multi-functional inputs and outputs. The modules are installed next to the sensors and actuators.

### Cube67 I/O modules

 <p><b>Bus nodes</b></p> <ul style="list-style-type: none"> <li>• PROFIBUS DP</li> <li>• PROFINET IO</li> <li>• EtherNet/IP</li> <li>• EtherCAT</li> </ul> <p style="text-align: right;"><i>Page 4.1.1</i></p>	 <p><b>Diagnostic gateway</b></p> <ul style="list-style-type: none"> <li>• Diagnostics made easy</li> <li>• Ethernet TCP/IP</li> </ul> <p style="text-align: right;"><i>Page 4.1.3</i></p>
 <p><b>Digital inputs</b></p> <ul style="list-style-type: none"> <li>• NPN</li> <li>• VPN</li> </ul> <p style="text-align: right;"><i>Page 4.1.4</i></p>	 <p><b>Digital inputs/outputs</b></p> <ul style="list-style-type: none"> <li>• Multifunctional</li> </ul> <p style="text-align: right;"><i>Page 4.1.7</i></p>
 <p><b>Function modules</b></p> <ul style="list-style-type: none"> <li>• IO-Link</li> <li>• Counter module</li> <li>• Communication module</li> </ul> <p style="text-align: right;"><i>Page 4.1.14</i></p>	<p style="text-align: center;"> <b>IO-Link</b></p>  <p><b>Analog inputs/outputs</b></p> <ul style="list-style-type: none"> <li>• Voltage/current</li> <li>• For resistors and temperature</li> <li>• For thermo elements</li> </ul> <p style="text-align: right;"><i>Page 4.1.17</i></p>
 <p><b>Safe outputs</b></p> <ul style="list-style-type: none"> <li>• Passive</li> </ul> <p style="text-align: right;"><i>Page 4.1.20</i></p>	 <p><b>Function modules hygenic design</b></p> <ul style="list-style-type: none"> <li>• Multifunctional</li> <li>• IO-Link</li> </ul> <p style="text-align: right;"> <b>IO-Link</b> <i>Page 4.1.21</i></p>
 <p><b>Cable/Valve</b></p> <ul style="list-style-type: none"> <li>• Digital outputs</li> <li>• Digital inputs/outputs (multifunctional)</li> <li>• Safe outputs</li> <li>• Valve connections</li> <li>• With open ended wires</li> </ul> <p style="text-align: right;"><i>Page 4.1.23</i></p>	 <p style="text-align: right;"><i>Please do not hesitate to contact us. We offer a wide range for Cube67 system cables.</i></p>



## HIGHLIGHTS OF THE CUBE SYSTEM

- **Customer-oriented installation concepts**, perfectly customized solutions for any given application
- **Great cost-benefit ratio** through lower planning and installation effort
- **Extreme flexibility** through multi-functional slots and numerous function modules (IO-Link, RS485/ MOVIMOT®...)
- System-independent through **"bus replacement without system replacement"** for all common bus systems worldwide
- **Maximized transparency** through precise and detailed diagnostics options

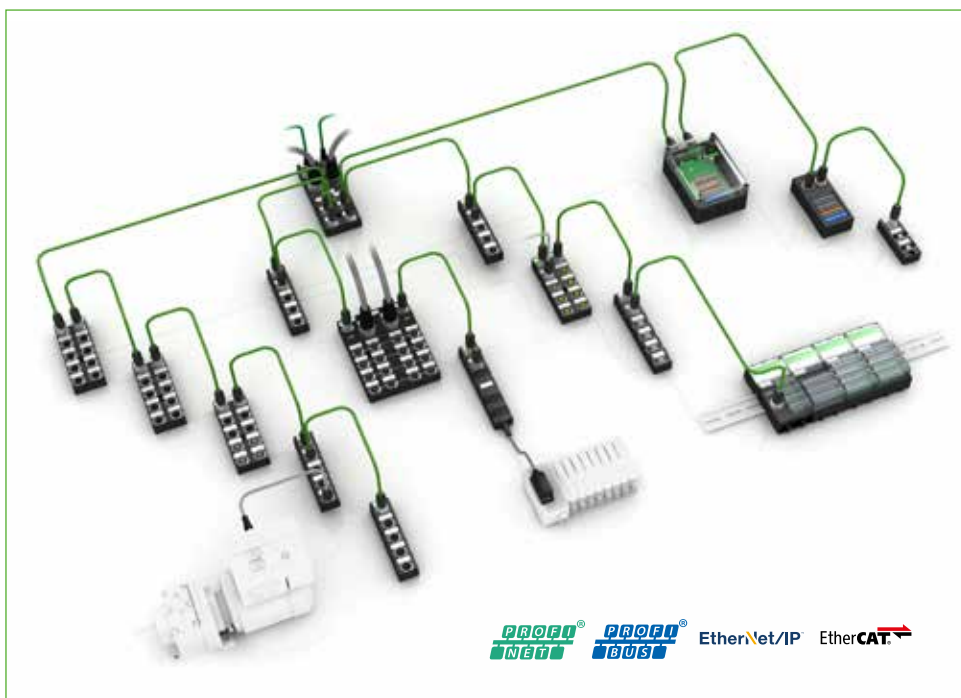

PROFI<sup>®</sup> NET EtherNet/IP EtherCAT<sup>®</sup>  
PROFI<sup>®</sup> BUS



## CUBE67 DIAGNOSTICS GATEWAY Diagnostics made easy

- **Commissioning engineers** use the diagnostics gateway to examine the topology of the Cube system and to detect installation faults at an early stage.
- The service personnel of the machine or system builder quickly identifies errors by temporarily integrating the diagnostics gateway. Moreover, this system is a perfect solution for machine acceptance tests. Permanent integration is also of great interest in order to be able to guide, for example the electrician, in the field via remote access.
- The **operator of a machine or system** who incorporates the diagnostics gateway permanently is able to react to potential problems at an early stage. In a best-case scenario, instructions for troubleshooting have already been implemented, allowing the installer to bring the required spare part right with him when he comes for repairs.

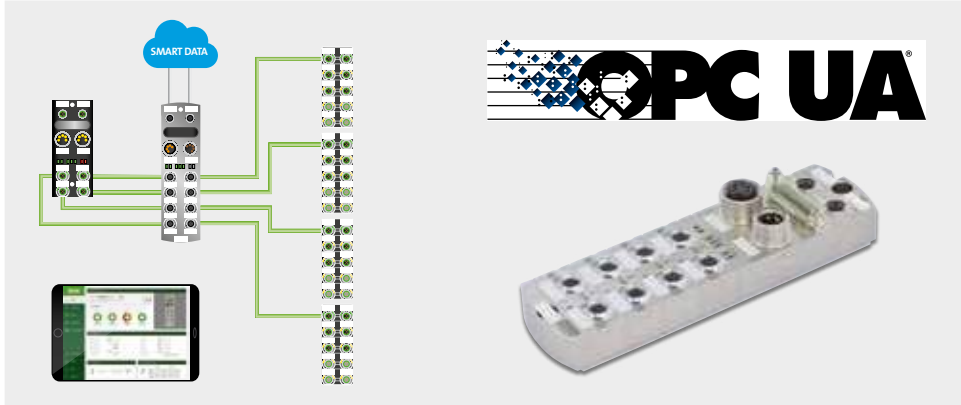

## FUNCTIONALITY WITH GREAT UTILIZABLE VALUE

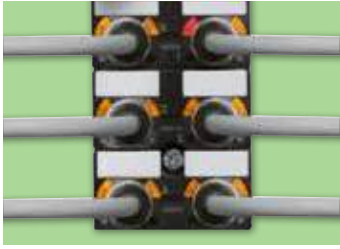

### Diagnostics

Detailed diagnostics messages to the controller and LED status indicators at the slots facilitate fast localization of errors. **This reduces commissioning time and downtimes.**



### Multi-functional I/Os

Connections can – depending on the requirement at any given location in the distributed installation – be parameterized as inputs, diagnostic inputs or outputs. This allows the connection of various components to a module. **As a result, there is great flexibility and a reduced number of variants.**

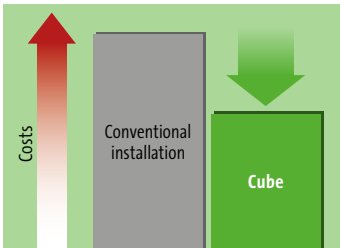

### Saves time and money

Maximized economy through reduced effort in design and installation of hardware and software. Increased production capacities and shorter lead times. **This is how Cube secures you a competitive edge.**



### Safety

Cube enables passive safety technology solutions. The M12 outputs and connections for the valve terminals can be used in installations up to category 3 and performance level d (according DIN EN ISO 13849). **This facilitates easy integration of safety technology without great wiring effort.**



### Cable

Cube67 only needs a single system bus cable for both power supply and data transmission. Prefabricated cables minimize error sources. **The installation requires just half the space and can be completed in half the time.**



### IO-Link by Murrelektronik

The integration of up to 128 smart IO-Link devices in Cube67+ opens up additional possibilities in using variable machines. Cube67+ in combination with IO-Link offers this additional functionality for M12 ports. **This enables flexible and automated parameterization of devices.**

# CUBE67

Bus nodes, Cube67+

– up to 32 modules



Approvals: UL<sub>us</sub> Listed

## Cube67+ BN-P

PROFIBUS DP



## Cube67+ BN-PNIO

PROFINET IO



Order Data	Art-No.	Art-No.
PROFIBUS DP	56521	
PROFINET IO		56526
<b>Connections</b>		
Fieldbus	PROFIBUS 12 Mbit/s; M12, B-coded	Ethernet 10/100Mbit/s; M12, D-coded
Sensor-system/actuator supply	7/8", 5-pole, 2 × max. 8 A	
Internal system connection	4 × M12 (female) A-coded, 6-pole, 2 × max. 4 A	
<b>Module Supply</b>		
Operating voltage	24 V DC (EN 61131-2)	
Current consumption	max. 120 mA	max. 200 mA
<b>PROFIBUS</b>		
Addressing	Rotary switch 0...99	–
<b>PROFINET</b>		
Addressing	–	DCP
Specification	–	V2.2, Conformance Class B
<b>Cube system</b>		
Module capacity	max. 32	
I/O capacity	max. 244 Byte (Input), max. 244 Byte (Output)	max. 1024 Byte (Input), max. 1024 Byte (Output)
Machine Option Management	yes	
No. of masterports (IO-Link)	max. 12	max. 128
<b>Diagnostic</b>		
Communication status	via LED and BUS	
Diagnostic via LED	per module and channel	
Diagnostic via BUS	per module and channel	
Monitoring - under voltage	yes	
Monitoring - no voltage	yes	
Short-circuit and overload	yes	
<b>General data</b>		
Protection	IP67	
Mounting method	2-hole screw mounting	
Temperature range	0...+55 °C (storage temperature -20...+75 °C)	
<b>Dimension drawing</b>		

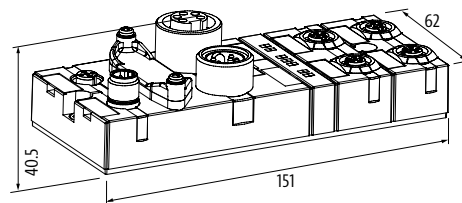

Notes
Cube67+ modules can only be operated on Cube67+, EtherNet/IP, Profibus + ProfiNet bus nodes.

# CUBE67

Bus nodes, Cube67+

– up to 32 modules

EtherNet/IP EtherCAT

Approvals:  Listed

Cube67+ BN-E

EtherNet/IP

Cube67+ BN-EC

EtherCAT



Order Data	Art-No.	Art-No.	Art-No.
EtherNet/IP	56535		
EtherCAT		56527	
EtherCAT Rotary Switch			5652701

### Connections

Fieldbus	Ethernet 10/100Mbit/s; M12, D-coded		
Sensor-system/actuator supply	7/8", 5-pole, 2 × max. 8 A		
Internal system connection	4 × M12 (female) A-coded, 6-pole, 2 × max. 4 A		

### Module Supply

Operating voltage	24 V DC (EN 61131-2)		
Current consumption	max. 200 mA		

### EtherNet/IP

Addressing	DHCP, BOOTP or IP address by rotary switch	–	
------------	--	---	--

### EtherCAT

Addressing	–	automatic	Rotary switch 0...999
------------	---	-----------	-----------------------

### Cube system

Module capacity	max. 32		
I/O capacity	max. 504 Byte (Input), max. 500 Byte (Output)		max. 65 636 Byte (Input), max. 65 636 Byte (Output)
Machine Option Management	yes		
No. of masterports (IO-Link)	max. 128		

### Diagnostic

Communication status	via LED and BUS		
Diagnostic via LED	per module and channel		
Diagnostic via BUS	per module and channel		
Monitoring - under voltage	yes		
Monitoring - no voltage	yes		
Short-circuit and overload	yes		

### General data

Protection	IP67		
Mounting method	2-hole screw mounting		
Temperature range	0...+55 °C (storage temperature -20...+75 °C)		

### Dimension drawing

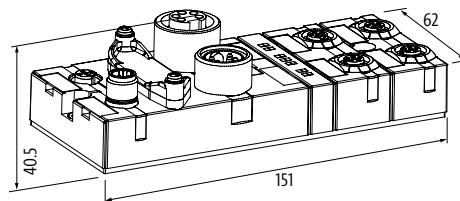

### Notes

Cube67+ modules can only be operated on Cube67+, EtherNet/IP, Profibus + ProfiNet bus nodes.

# CUBE67

Diagnostic gateway

– Ethernet TCP/IP

## Cube67

Diagnostics made easy



Approvals:  UL  
Listed

Order Data		Art-No.
Diagnostic Gateway		56968
Connections		
Fieldbus	2 x M12 (female), D-coded	
Internal system connection	8 x M12 (female), 6-pole	
Supply	2 x 7/8" (male/female), 5-pole	
Module Supply		
Operating voltage	24 V DC ±25%	
Current consumption	max. 200 mA	
Cube system		
Cube67 system connection	yes	
Protection		
Reverse polarity protection module	yes	
Over voltage protection	yes	
General data		
Protection	IP67	
Mounting method	2-hole screw mounting	
Temperature range	0...+55 °C (storage temperature -25...+70 °C)	
Dimension drawing		

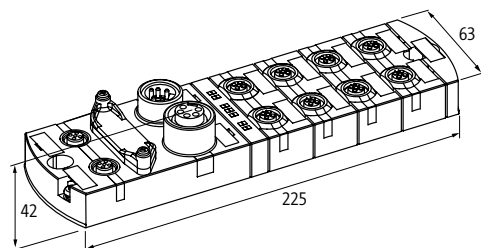

Notes	
	Current manuals can be downloaded at: <a href="http://www.murrelektronik.com">www.murrelektronik.com</a>

# CUBE67

## Digital inputs

### Cube67 DI16 C - 8×M12

Compact module



### Cube67 DI8 C - 4×M12

Compact module



### Cube67 DI8 C - 8×M8

Compact module

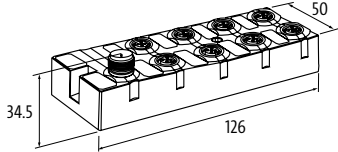
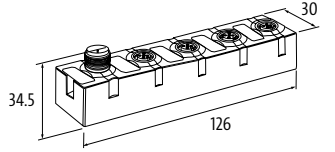
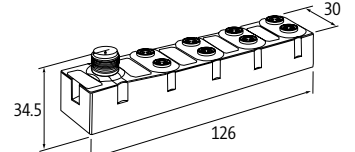

Approvals:  Listed

Order Data	Art-No.	Art-No.	Art-No.
DI16 - (C) 8×M12	56602		
DI8 - (C) 4×M12		56612	
DI8 - (C) 8×M8			56622
<b>Internal communication</b>			
Current consumption	max. 50 mA		max. 30 mA
LED display	US: sensor supply and internal supply voltage (green: OK); UA: actuator supply (green: OK)		
Terminating resistor	integrated into the module		
<b>Connections</b>			
Fieldbus	via internal system connection		
Sensor-system/actuator supply	via internal system connection (max. 2×4 A)		
I/O ports	M12 (female) 5-pole, A-coded		M8 (female) 3-pole, A-coded
<b>Input</b>			
Sensor supply US	24 V DC (EN 61131-2), max. 200 mA (M12 female), short-circuit and overload protected		24 V DC (EN 61131-2), max. 200 mA (M8 female), short-circuit and overload protected
Type	for 3-wire sensors or mechanical switches, PNP		
Input filter	1 ms		
<b>Parameterization</b>			
PIN 2	Input/Diagnostic	-	
PIN 4	Input		
<b>Diagnostic</b>			
Communication status	via LED		
Diagnostic via LED	per module and channel		
Diagnostic via BUS	per module and channel		
Monitoring - under voltage	yes		
Monitoring - no voltage	yes		
Short-circuit and overload	yes		
<b>General data</b>			
Protection	IP67		
Mounting method	2-hole screw mounting		
Temperature range	0...+55 °C (storage temperature -20...+75 °C)		
<b>Dimension drawing</b>			
			
<b>Notes</b>			

# CUBE67

## Digital inputs

### Cube67 DI16 E - 8×M12

Expansion module



### Cube67 DI8 E - 4×M12

Expansion module



### Cube67 DI8 E - 8×M8

Expansion module



Approvals: UL<sub>us</sub>  
Listed

Order Data	Art-No.	Art-No.	Art-No.
DI16 - (E) PNP (8×M12)	56603		
DI8 - (E) PNP (4×M12)		56613	
DI8 - (E) PNP (8×M8)			56623
<b>Internal communication</b>			
Current consumption	max. 50 mA		max. 30 mA
LED display	US: sensor supply and internal supply voltage (green: OK); UA: actuator supply (green: OK)		
<b>Connections</b>			
Fieldbus	via internal system connection		
Sensor-system/actuator supply	via internal system connection (max. 2×4 A)		
I/O ports	M12 (female) 5-pole, A-coded		M8 (female) 3-pole, A-coded
<b>Input</b>			
Sensor supply US	24 V DC (EN 61131-2), max. 200 mA (M12 female), short-circuit and overload protected		24 V DC (EN 61131-2), max. 200 mA (M8 female), short-circuit and overload protected
Type	for 3-wire sensors or mechanical switches, PNP		
Input filter	1 ms		
<b>Parameterization</b>			
PIN 2	Input/Diagnostic	-	
PIN 4	Input		
<b>Diagnostic</b>			
Communication status	via LED		
Diagnostic via LED	per module and channel		
Diagnostic via BUS	per module and channel		
Monitoring - under voltage	yes		
Monitoring - no voltage	yes		
Short-circuit and overload	yes		
<b>General data</b>			
Protection	IP67		
Mounting method	2-hole screw mounting		
Temperature range	0...+55 °C (storage temperature -20...+75 °C)		

### Dimension drawing

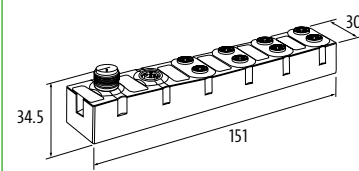
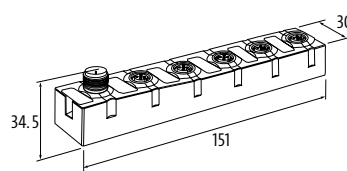
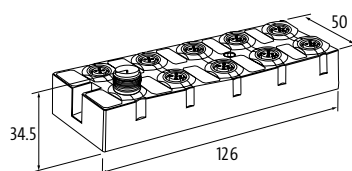

<b>Notes</b>	
--------------	--

# CUBE67

## Digital inputs

### Cube67 DI16 E - 8×M12

Expansion module  
Form NPN



### Cube67 DI8 E - 4×M12

Expansion module  
Form NPN



### Cube67 DI8 E - 8×M8

Expansion module  
Form NPN

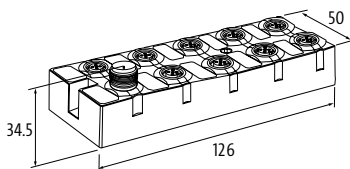
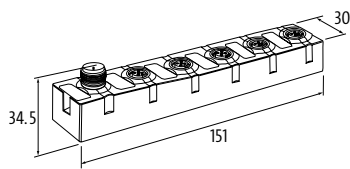
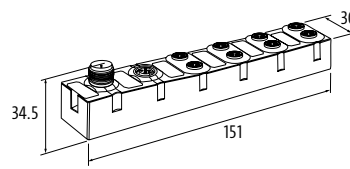

Approvals:  Listed

Order Data	Art-No.	Art-No.	Art-No.
DI16 - (E) NPN (8×M12)	56606		
DI8 - (E) NPN (4×M12)		56616	
DI8 - (E) NPN (8×M8)			56626
<b>Internal communication</b>			
Current consumption	max. 50 mA		max. 30 mA
LED display	US: sensor supply and internal supply voltage (green: OK); UA: actuator supply (green: OK)		
<b>Connections</b>			
Fieldbus	via internal system connection		
Sensor-system/actuator supply	via internal system connection (max. 2×4 A)		
I/O ports	M12 (female) 5-pole, A-coded		M8 (female) 3-pole, A-coded
<b>Input</b>			
Sensor supply US	24 V DC (EN 61131-2), max. 200 mA (M12 female), short-circuit and overload protected		24 V DC (EN 61131-2), max. 200 mA (M8 female), short-circuit and overload protected
Type	for 3-wire sensors or mechanical switches, NPN, (EN 61131-2)		
Input filter	1 ms		
<b>Parameterization</b>			
PIN 2	Input/Diagnostic	-	
PIN 4	Input		
<b>Diagnostic</b>			
Communication status	via LED		
Diagnostic via LED	per module and channel		
Diagnostic via BUS	per module and channel		
Monitoring - under voltage	yes		
Monitoring - no voltage	yes		
Short-circuit and overload	yes		
<b>General data</b>			
Protection	IP67		
Mounting method	2-hole screw mounting		
Temperature range	0...+55 °C (storage temperature -20...+75 °C)		
<b>Dimension drawing</b>			
			
<b>Notes</b>			



# CUBE67

## Digital inputs/outputs (multifunctional)

### Cube67 DIO16 C - 8xM12

Compact module  
additional actuator supply 1 x 4 A



Approvals:  UL  
Listed

Order Data	Art-No.	Art-No.
DIO16 - 0.5 A (C) 8xM12	56600	
DIO16 - 1.6 A (C) 8xM12		56640
<b>Internal communication</b>		
Current consumption	max. 50 mA	
LED display	US: sensor supply and internal supply voltage (green: OK); UA: actuator supply (green: OK)	
Terminating resistor	integrated into the module	
<b>Connections</b>		
Fieldbus	via internal system connection	
Sensor-system/actuator supply	via internal system connection (max. 2x4 A)	
I/O ports	M12 (female) 5-pole, A-coded	
<b>Input</b>		
Sensor supply US	24 V DC (EN 61131-2), max. 200 mA (M12 female), short-circuit and overload protected	
Type	for 3-wire sensors or mechanical switches, PNP	
Input filter	1 ms	
<b>Output</b>		
Actuator supply UA	24 V DC (EN 61131-2), via system connection (max. 4 A) + right actuators via supply right (max. 4 A)	
Switching current per output	max. 0.5 A (short-circuit and overload protected)	max. 1.6 A (short-circuit and overload protected)
<b>Parameterization</b>		
PIN 2	Input/Output/Diagnostic	
PIN 4	Input/Output	
<b>Diagnostic</b>		
Communication status	via LED	
Diagnostic via LED	per module and channel	
Diagnostic via BUS	per module and channel	
Monitoring - under voltage	yes	
Monitoring - no voltage	yes	
Short-circuit and overload	yes	
Actuator warning	per channel via LED and BUS	
<b>General data</b>		
Protection	IP67	
Mounting method	2-hole screw mounting	
Temperature range	0...+55 °C (storage temperature -20...+75 °C)	
<b>Dimension drawing</b>		

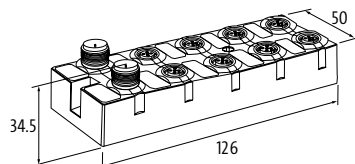

### Notes

# CUBE67

## Digital inputs/outputs (multifunctional)

### Cube67 DIO8 C - 4×M12

Compact module



### Cube67 DIO8 C - 8×M12

Compact module



Approvals:  UL US  
Listed

Order Data	Art-No.	Art-No.
DIO8 - 0.5 A (C) 4×M12	56610	
DIO8 - 0.5 A (C) 8×M8		56620
<b>Internal communication</b>		
Current consumption	max. 50 mA	max. 30 mA
LED display	US: sensor supply and internal supply voltage (green: OK); UA: actuator supply (green: OK)	
Terminating resistor	integrated into the module	
<b>Connections</b>		
Fieldbus	via internal system connection	
Sensor-system/actuator supply	via internal system connection (max. 2×4 A)	
I/O ports	M12 (female) 5-pole, A-coded	M8 (female) 3-pole, A-coded
<b>Input</b>		
Sensor supply US	24 V DC (EN 61131-2), max. 200 mA (M12 female), short-circuit and overload protected	24 V DC (EN 61131-2), max. 200 mA (M8 female), short-circuit and overload protected
Type	for 3-wire sensors or mechanical switches, PNP	
Input filter	1 ms	
<b>Output</b>		
Actuator supply UA	24 V DC (EN 61131-2), via system connection (max. 4 A)	
Switching current per output	max. 0.5 A (short-circuit and overload protected)	
<b>Parameterization</b>		
PIN 2	Input/Output/Diagnostic	–
PIN 4	Input/Output	
<b>Diagnostic</b>		
Communication status	via LED	
Diagnostic via LED	per module and channel	
Diagnostic via BUS	per module and channel	
Monitoring - under voltage	yes	
Monitoring - no voltage	yes	
Short-circuit and overload	yes	
Actuator warning	per channel via LED and BUS	
<b>General data</b>		
Protection	IP67	
Mounting method	2-hole screw mounting	
Temperature range	0...+55 °C (storage temperature -20...+75 °C)	
<b>Dimension drawing</b>		

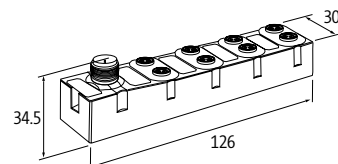
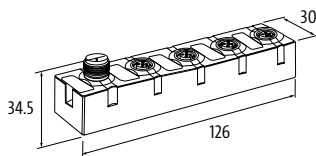

## Notes

# CUBE67

## Digital inputs/outputs (multifunctional)



### Cube67 DIO16 E - 8×M12

Expansion module



### Cube67 DIO8 E - 4×M12

Expansion module



Cube67

Order Data	Art-No.	Art-No.
DIO16 - 0.5 A (E) 8×M12	56601	
DIO8 - 0.5 A (E) 4×M12		56611
<b>Internal communication</b>		
Current consumption	max. 50 mA	
LED display	US: sensor supply and internal supply voltage (green: OK); UA: actuator supply (green: OK)	
<b>Connections</b>		
Fieldbus	via internal system connection	
Sensor-system/actuator supply	via internal system connection (max. 2×4 A)	
I/O ports	M12 (female) 5-pole, A-coded	
<b>Input</b>		
Sensor supply US	24 V DC (EN 61131-2), max. 200 mA (M12 female), short-circuit and overload protected	
Type	for 3-wire sensors or mechanical switches, PNP	
Input filter	1 ms	
<b>Output</b>		
Actuator supply UA	24 V DC (EN 61131-2), via system connection (max. 4 A)	
Switching current per output	max. 0.5 A (short-circuit and overload protected)	
<b>Parameterization</b>		
PIN 2	Input/Output/Diagnostic	
PIN 4	Input/Output	
<b>Diagnostic</b>		
Communication status	via LED	
Diagnostic via LED	per module and channel	
Diagnostic via BUS	per module and channel	
Monitoring - under voltage	yes	
Monitoring - no voltage	yes	
Short-circuit and overload	yes	
Actuator warning	per channel via LED and BUS	
<b>General data</b>		
Protection	IP67	
Mounting method	2-hole screw mounting	
Temperature range	0...+55 °C (storage temperature -20...+75 °C)	
<b>Dimension drawing</b>		

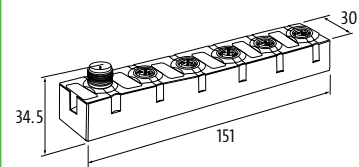
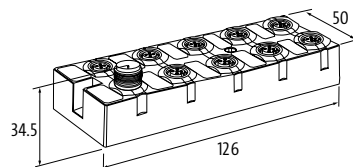

Notes

# CUBE67

## Digital inputs/outputs (multifunctional)

### Cube67 DIO8 E - 4×M12

Expansion module



### Cube67 DIO8 E - 8×M8

Expansion module

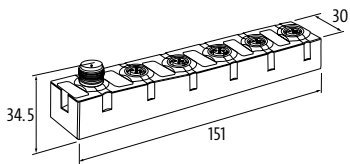
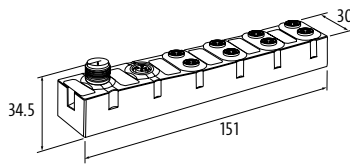

Approvals:  US Listed

Order Data	Art-No.	Art-No.
DIO8 - 1.0 A (E) 4×M12	56631	
DIO8 - 0.5 A (E) 8×M8		56621
<b>Internal communication</b>		
Current consumption	max. 50 mA	max. 30 mA
LED display	US: sensor supply and internal supply voltage (green: OK); UA: actuator supply (green: OK)	
<b>Connections</b>		
Fieldbus	via internal system connection	
Sensor-system/actuator supply	via internal system connection (max. 2×4 A)	
I/O ports	M12 (female) 5-pole, A-coded	M8 (female) 3-pole, A-coded
<b>Input</b>		
Sensor supply US	24 V DC (EN 61131-2), max. 200 mA (M12 female), short-circuit and overload protected	24 V DC (EN 61131-2), max. 200 mA (M8 female), short-circuit and overload protected
Type	for 3-wire sensors or mechanical switches, PNP	
Input filter	1 ms	
<b>Output</b>		
Actuator supply UA	24 V DC (EN 61131-2), via system connection (max. 4 A)	
Switching current per output	max. 1 A (short-circuit and overload protected)	max. 0.5 A (short-circuit and overload protected)
<b>Parameterization</b>		
PIN 2	Input/Output/Diagnostic	–
PIN 4	Input/Output	
<b>Diagnostic</b>		
Communication status	via LED	
Diagnostic via LED	per module and channel	
Diagnostic via BUS	per module and channel	
Monitoring - under voltage	yes	
Monitoring - no voltage	yes	
Short-circuit and overload	yes	
Actuator warning	per channel via LED and BUS	
<b>General data</b>		
Protection	IP67	
Mounting method	2-hole screw mounting	
Temperature range	0...+55 °C (storage temperature -20...+75 °C)	
<b>Dimension drawing</b>		
		
<b>Notes</b>		

# CUBE67

## Digital inputs/outputs (multifunctional)



### Cube67 DIO8 C - 4xM8

Compact module  
4-pole



### Cube67 DIO8 E - 0.5 A 8xM8

Expansion module  
4-pole



Cube67

#### Contact layout

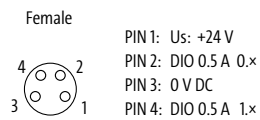

Order Data	Art-No.	Art-No.
DIO8 - 0.5 A (C) 4xM8	56627	
DIO16 - 0.5 A (E) 8xM8		56625

Internal communication	
Current consumption	max. 30 mA
LED display	US: sensor supply and internal supply voltage (green: OK); UA: actuator supply (green: OK)
Connections	
Fieldbus	via internal system connection
Sensor-system/actuator supply	via internal system connection (max. 2x4 A)
I/O ports	M8 (female), 4-pole, A-coded
Input	
Sensor supply US	24 V DC (EN 61131-2), max. 200 mA (M8 female), short-circuit and overload protected
Type	for 3-wire sensors or mechanical switches, PNP
Input filter	1 ms
Output	
Actuator supply UA	24 V DC (EN 61131-2), via system connection (max. 4 A)
Switching current per output	max. 0.5 A (short-circuit and overload protected)
Parameterization	
PIN 4	Input/Output
PIN 2	Input/Output/Diagnostic
Diagnostic	
Communication status	via LED
Diagnostic via LED	per module and channel
Diagnostic via BUS	per module and channel
Monitoring - under voltage	yes
Monitoring - no voltage	yes
Short-circuit and overload	yes
Actuator warning	per channel via LED and BUS
General data	
Protection	IP67
Mounting method	2-hole screw mounting
Temperature range	0...+55 °C (storage temperature -20...+75 °C)
Dimension drawing	

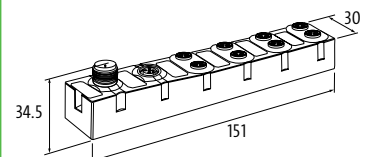
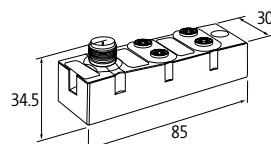

# CUBE67

## Digital inputs/outputs (multifunctional)

### Cube67 DIO32 E - 16×M12

Expansion module



### Cube67 DIO16 DO16 E - 1.6/2 A 16×M12

Expansion module



Order Data	Art-No.	Art-No.
DIO32 - 0.5 A (E) 16×M12	56642	
DIO16 - 1.6 A DO16 - 2 A (E) 16×M12		56641
Internal communication		
Current consumption	max. 60 mA	max. 50 mA
LED display	US: sensor supply and internal supply voltage (green: OK); UA: actuator supply (green: OK)	
Connections		
Fieldbus	via internal system connection	
Sensor-system/actuator supply	via internal system connection (max. 2×4 A)	
I/O ports	M12 (female) 5-pole, A-coded	
Input		
Sensor supply US	24 V DC (EN 61131-2), max. 200 mA (M12 female), short-circuit and overload protected	
Type	for 3-wire sensors or mechanical switches, PNP	
Input filter	1 ms	
Output		
Actuator supply (8×M12 left side)	24 V DC (EN 61131-2), via 7/8" male (max. 1 × 9 A)	24 V DC (EN 61131-2), via 7/8" male (max. 2 × 9 A)
Actuator supply (8×M12 right side)	24 V DC (EN 61131-2), via 7/8" male (max. 1 × 9 A)	24 V DC (EN 61131-2), via 7/8" male (max. 2 × 9 A)
Switching current per output (8×M12 left)	max. 0.5 A (short-circuit and overload protected)	max. 1.6 A (short-circuit and overload protected), coincidence factor 50% per port
Switching current per output (8×M12 right)	max. 0.5 A (short-circuit and overload protected)	max. 2 A (short-circuit and overload protected), coincidence factor 50% per port
Parameterization		
PIN 2 (8 × M12 left side)	Input/Output/Diagnostic	
PIN 4 (8 × M12 left side)	Input/Output	
PIN 2 (8 × M12 right side)	Input/Output/Diagnostic	Output
PIN 4 (8 × M12 right side)	Input/Output	Output
Diagnostic		
Communication status	via LED	
Diagnostic via LED	per module and channel	
Diagnostic via BUS	per module and channel	
Monitoring - under voltage	yes	
Monitoring - no voltage	yes	
Short-circuit and overload	yes	
Actuator warning	per channel via LED and BUS	
General data		
Protection	IP67	
Mounting method	4 hole screw mounting	
Temperature range	0...+55 °C (storage temperature -20...+75 °C)	

### Dimension drawing

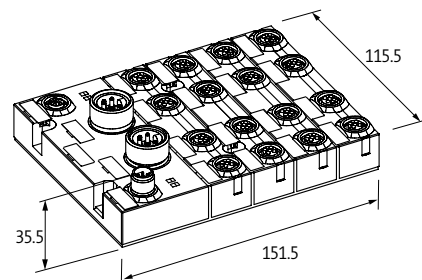
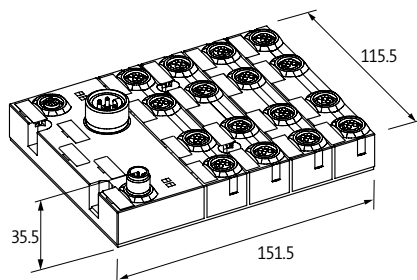

# CUBE67

## Terminal modules

– Digital inputs/outputs (multifunctional)

– Digital inputs

### Cube67 DIO8/DI8 E (TB-Box)

Expansion module



### Cube67 DIO8/DI8 E (TB-Box)

Expansion module with additional potential terminals

### Cube67 DIO8/DI8 E (TB-Rail)

Expansion module



Cube67

Order Data	Art-No.	Art-No.	Art-No.
DIO8/DI8 - (E) TB-Box	56681	5668100	
DIO8/DI8 - (E) TB-Rail			cULus 56691
<b>Internal communication</b>			
Current consumption	max. 50 mA		
LED display	US: sensor supply and internal supply voltage (green: OK); UA: actuator supply (green: OK)		
<b>Connections</b>			
Fieldbus	via internal system connection		
Sensor-system/actuator supply	via internal system connection (max. 2x4 A)		
I/O ports	16 × Spring clamp plug-in terminals, max. 2.5 mm <sup>2</sup>		
<b>Input</b>			
Sensor supply US	24 V DC (EN 61131-2), max. 8 × 200 mA		
Type	for 3-wire sensors or mechanical switches, PNP		
Input filter	1 ms		
<b>Output</b>			
Actuator supply UA	24 V DC (EN 61131-2), via system connection (max. 4 A)		
Switching current per output	max. 0.5 A (short-circuit and overload protected)		
<b>Parameterization</b>			
Terminal row X0 (8 channels)	Input		
Terminal row X1 (8 channels)	Input/Output		
<b>Diagnostic</b>			
Communication status	via LED		
Diagnostic via LED	per module and channel		
Diagnostic via BUS	per module and channel		
Monitoring - under voltage	yes		
Monitoring - no voltage	yes		
Short-circuit and overload	yes		
Actuator warning	per channel via LED and BUS		
<b>General data</b>			
Protection	IP66		IP20
Mounting method	screw fixing		DIN-rail mountable (EN 60715)
Temperature range	0...+55 °C (storage temperature -20...+75 °C)		
<b>Dimension drawing</b>			
<b>Notes</b>			

# CUBE67

## Function modules

– multifunctional

– IO-Link Master

IO-Link

Approvals:  Listed

## Cube67+ DIO12 IOL4 - E 8×M12

Expansion module



Order Data	Art-No.
DIO12/IOL4 - (E) 8×M12	56766
Internal communication	
Current consumption	max. 100 mA
LED display	US: sensor supply (green: OK); IOL: (green: OK); UA: actuator supply (green: OK)
Connections	
Fieldbus	via internal system connection
Sensor-system/actuator supply	via internal system connection (max. 2×4 A)
I/O ports	M12 (female) 5-pole, A-coded
IO-Link	
IO-Link	4 × Master
Operating modes	COM1; COM2; COM3 (automatic)
Transfer parameters	32 Byte (via IO-Link Port)
Port class	Class A + B (not galvanically separated)
Specification	IO-Link Master V1.12
Input	
Sensor supply US	24 V DC (EN 61131-2), max. 200 mA (port 0...3); max. 700 mA (port 4...7)
Type	for 3-wire sensors or mechanical switches, PNP
Input filter	1 ms
Output	
Actuator supply UA	24 V DC (EN 61131-2), via system connection (max. 4 A)
Switching current per output	max. 1.6 A (short-circuit and overload protected)
Parameterization	
PIN 2	Input/Output/Diagnostic
PIN 4	Input/Output (port 0...3); IO-Link Master (port 4...7)
Diagnostic	
Communication status	via LED
Diagnostic via LED	per module and channel
Diagnostic via BUS	per module and channel
Monitoring - under voltage	yes
Monitoring - no voltage	yes
Short-circuit and overload	yes
Actuator warning	per channel via LED and BUS
General data	
Protection	IP67
Mounting method	2-hole screw mounting
Temperature range	0...+55 °C (storage temperature -20...+75 °C)
Dimension drawing	

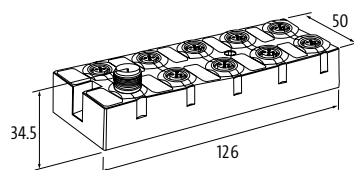

Notes	
	Cube67+ modules can only be operated on Cube67+, EtherNet/IP, Profibus + ProfiNet bus nodes.



# CUBE67

## Function modules

### – Counter module with preprocessing

#### Cube67 CNT2 - C 4xM12

Compact module



Approvals:  UL  
Listed

Order Data		Art-No.
Compact module		56750
Internal communication		
Current consumption	max. 50 mA	
LED display	US: sensor supply and internal supply voltage (green: OK); UA: actuator supply (green: OK)	
Connections		
Fieldbus	via internal system connection	
Sensor-system/actuator supply	via internal system connection (max. 2x4 A)	
I/O ports	M12 (female) 5-pole, A-coded	
Input		
Sensor supply US	24 V DC (EN 61131-2), max. 200 mA (M12 female), short-circuit and overload protected	
Type	for 3-wire sensors or mechanical switches, PNP	
Input filter	1 ms	
Output		
Actuator supply UA	24 V DC (EN 61131-2), via system connection (max. 4 A)	
Switching current per output	max. 1.6 A (short-circuit and overload protected)	
Counter		
Counter frequency	max. 300 kHz	
Counter input	EN 61131-2	
Counter depth	32 Bit (31 Bit + sign)	
Diagnostic		
Communication status	via LED	
Diagnostic via LED	per module and channel	
Diagnostic via BUS	per module and channel	
Monitoring - under voltage	yes	
Monitoring - no voltage	yes	
Short-circuit and overload	yes	
Actuator warning	per channel via LED and BUS	
General data		
Protection	IP67	
Mounting method	2-hole screw mounting	
Temperature range	0...+55 °C (storage temperature -20...+75 °C)	
Dimension drawing		

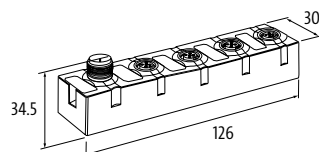

#### Notes

Cube67+ modules can only be operated on Cube67+, EtherNet/IP, Profibus + ProfiNet bus nodes.

# CUBE67

## Function modules

### – Communication module

Approvals:  Listed

### Cube67+ DIO4 RS232/485 - E 4×M12 MOVIMOT®

Expansion module  
Serial interface



Order Data	Art-No.
DIO4 - (E) RS232/485 (4×M12) MOVIMOT®	56761
Internal communication	
Current consumption	max. 80 mA
LED display	US: sensor supply and internal supply voltage (green: OK); UA: actuator supply (green: OK)
Connections	
Fieldbus	via internal system connection
Sensor-system/actuator supply	via internal system connection (max. 2×4 A)
I/O ports	M12 (female) 5-pole, A-coded
Technical Data	
Transfer parameters	RS232: 230.4 kBaud, full duplex; RS485: 230.4 kBaud, half duplex
RS232-Type	galvanically separated, M12 female 5-pole, B-coded
RS485-Type	galvanically separated, M12 female 5-pole, B-coded
Input	
Sensor supply US	24 V DC (EN 61131-2), max. 200 mA (M12 female), short-circuit and overload protected
Type	for 3-wire sensors or mechanical switches, PNP
Input filter	1 ms
Output	
Actuator supply UA	24 V DC (EN 61131-2), via system connection (max. 4 A)
Switching current per output	max. 0.5 A (short-circuit and overload protected)
Parameterization	
PIN 2	Input/Output/Diagnostic
PIN 4	Input/Output
Diagnostic	
Communication status	via LED
Diagnostic via LED	per module and channel
Diagnostic via BUS	per module and channel
Monitoring - under voltage	yes
Monitoring - no voltage	yes
Short-circuit and overload	yes
Actuator warning	per channel via LED and BUS
General data	
Protection	IP67
Mounting method	2-hole screw mounting
Temperature range	0...+55 °C (storage temperature -20...+75 °C)
Dimension drawing	

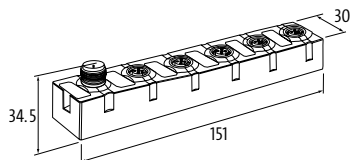

Notes	
	Cube67+ modules can only be operated on Cube67+, EtherNet/IP, Profibus + ProfiNet bus nodes.

# CUBE67

## Analog inputs

### – Voltage/current

#### Cube67 AI4 C - 4×M12

Compact module  
Voltage

#### Cube67 AI4 C - 4×M12

Compact module  
Current

#### Cube67 AI4 E - 4×M12

Expansion module  
Voltage

#### Cube67 AI4 E - 4×M12

Expansion module  
Current



Order Data	Art-No.	Art-No.	Art-No.	Art-No.
AI4 - (C) 4×M12 (U)	cULus	<b>56700</b>		
AI4 - (C) 4×M12 (I)			cULus	<b>56730</b>
AI4 - (E) 4×M12 (U)			cULus	<b>56701</b>
AI4 - (E) 4×M12 (I)				<b>56731</b>
<b>Internal communication</b>				
Current consumption	max. 50 mA			
LED display	US: sensor supply and internal supply voltage (green: OK); UA: actuator supply (green: OK)			
<b>Connections</b>				
Fieldbus	via internal system connection			
Sensor-system/actuator supply	via internal system connection (max. 2×4 A)			
I/O ports	M12 (female) 5-pole, A-coded			
<b>Input</b>				
Conversion time (analog)	approx. 2 ms (per channel)			
Sensor supply US	24 V DC (EN 61131-2), max. 200 mA (M12 female), short-circuit and overload protected			
Resolution (analog)	15 Bit + sign	15 Bit	15 Bit + sign	15 Bit
Accuracy	max. ±0.5% (of range limit)			
<b>Voltage inputs</b>				
Input resistor	approx. 1 MOhm, differential input	–	approx. 1 MOhm, differential input	–
Input range	±10 V DC, 0...10 V DC	–	±10 V DC, 0...10 V DC	–
<b>Current input signals</b>				
Load	–	approx. 300 Ohm, differential input	–	approx. 300 Ohm, differential input
Input range	–	0...20 mA, 4...20 mA	–	0...20 mA, 4...20 mA
<b>Diagnostic</b>				
Communication status	via LED			
Diagnostic via LED	per module and channel			
Diagnostic via BUS	per module and channel			
Monitoring - under voltage	yes			
Monitoring - no voltage	yes			
Short-circuit and overload	yes			
Actuator warning	per channel via LED and BUS			
Wire break upper/lower limit overload	per channel via LED and BUS			
<b>General data</b>				
Protection	IP67			
Mounting method	2-hole screw mounting			
Temperature range	0...+55 °C (storage temperature -20...+75 °C)			
<b>Dimension drawing</b>				
<b>Notes</b>				

# CUBE67

## Analog inputs

– for resistors and temperature

– for thermo elements

### Cube67 AI4 C (RTD) - 4×M12

Compact module  
for resistors and temperature



### Cube67 AI4 C (TH) - 4×M12

Compact module  
for thermo elements

### Cube67 AI4 E (RTD) - 4×M12

Expansion module  
for resistors and temperature



### Cube67 AI4 E (TH) - 4×M12

Expansion module  
for thermo elements

Order Data	Art-No.	Art-No.	Art-No.	Art-No.
AI4 - (C) 4×M12 (RTD)	cUlus	<b>56740</b>		
AI4 - (C) 4×M12 (TH)		cUlus	<b>56748</b>	
AI4 - (E) 4×M12 (RTD)			<b>56741</b>	
AI4 - (E) 4×M12 (TH)				<b>56749</b>

### Internal communication

Current consumption	max. 50 mA
LED display	US: sensor supply and internal supply voltage (green: OK); UA: actuator supply (green: OK)

### Connections

Fieldbus	via internal system connection
Sensor-system/actuator supply	via internal system connection (max. 2×4 A)
I/O ports	M12 (female) 5-pole, A-coded

### Input

Input	Art-No. 56740	Art-No. 56748	Art-No. 56741	Art-No. 56749
Sensor type	Pt100, 200, 500, 1000; Ni100, 120, 200, 500, 1000; R 0...3000 Ohm	K, N, J, E, R	Pt100, 200, 500, 1000; Ni100, 120, 200, 500, 1000; R 0...3000 Ohm	K, N, J, E, R
Conversion time (analog)	approx. 58 ms per channel	approx. 65 ms per channel	approx. 58 ms per channel	approx. 65 ms per channel
Resolution (analog)	15 Bit + sign			
Accuracy	max. ±0.5% (of range limit)			
Accuracy (Ni)	max. ±1% (of range limit)	–	max. ±1% (of range limit)	–
Connection	2-, 3-, 4-wire technology	2-wire technology	2-, 3-, 4-wire technology	2-wire technology
Cold junction compensation	–	inside M12 connector	–	inside M12 connector

### Diagnostic

Communication status	via LED
Diagnostic via LED	per module and channel
Diagnostic via BUS	per module and channel
Monitoring - under voltage	yes
Monitoring - no voltage	yes
Short-circuit and overload	yes
Actuator warning	per channel via LED and BUS
Wire break upper/lower limit overload	per channel via LED and BUS

### General data

Protection	IP67
Mounting method	2-hole screw mounting
Temperature range	0...+55 °C (storage temperature -20...+75 °C)

### Dimension drawing

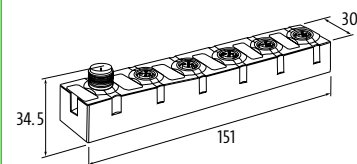
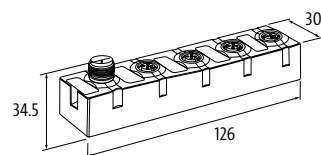

### Notes

# CUBE67

## Analog outputs

### – Voltage/current

#### Cube67 AO4 C 4×M12

Compact module  
Voltage

#### Cube67 AO4 C 4×M12

Compact module  
Current

#### Cube67 AO4 E 4×M12

Expansion module  
Voltage

#### Cube67 AO4 E 4×M12

Expansion module  
Current



Order Data	Art-No.	Art-No.	Art-No.	Art-No.
AO4 - (C) 4×M12 (U)	cULus	<b>56710</b>		
AO4 - (C) 4×M12 (I)		cULus	<b>56720</b>	
AO4 - (E) 4×M12 (U)			<b>56711</b>	
AO4 - (E) 4×M12 (I)				<b>56721</b>

Internal communication				
Current consumption	max. 50 mA			
LED display	US: sensor supply and internal supply voltage (green: OK); UA: actuator supply (green: OK)			
Connections				
Fieldbus	via internal system connection			
Sensor-system/actuator supply	via internal system connection (max. 2×4 A)			
I/O ports	M12 (female) 5-pole, A-coded			
Output				
Supply voltage	24 V DC (EN 61131-2), via system connection (max. 4 A)			
Conversion time (analog)	approx. 1 ms (per channel)			
Actuator supply UA	24 V DC (EN 61131-2), max. 1.6 A per M12 female, (short-circuit and overload protected)			
Resolution (analog)	11 Bit + sign	11 Bit	11 Bit + sign	11 Bit
Accuracy	max. ±0.5% (of range limit)			
Voltage output signals				
Load	min. 500 Ohm	–	min. 500 Ohm	–
Input range	±10 V DC, 0...10 V DC	–	±10 V DC, 0...10 V DC	–
Current outputs				
Load	–	max. 500 Ohm	–	max. 500 Ohm
Input range	–	0...20 mA, 4...20 mA	–	0...20 mA, 4...20 mA
Diagnostic				
Communication status	via LED			
Diagnostic via LED	per module and channel			
Diagnostic via BUS	per module and channel			
Monitoring - under voltage	yes			
Monitoring - no voltage	yes			
Short-circuit and overload	yes			
Actuator warning	per channel via LED and BUS			
Wire break upper/lower limit overload	per channel via LED and BUS			
General data				
Protection	IP67			
Mounting method	2-hole screw mounting			
Temperature range	0...+55 °C (storage temperature -20...+75 °C)			

### Dimension drawing

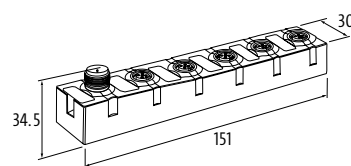
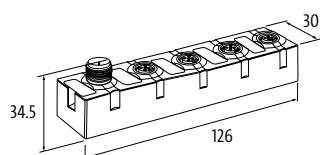

### Notes

# CUBE67

## Safe outputs (Safety)

- passive safety
- Output groups up to PLd (EN ISO 13849-1) can be switched off via safety relays

Approvals:  UL US  
Listed

## Cube67 DO6/DO6 - E 6xM12 (K3)

Expansion module



Order Data	Art-No.
DO6/DO6 - (E) 6xM12 (K3)	56605
Internal communication	
Current consumption	max. 50 mA
LED display	US: sensor supply and internal supply voltage (green: OK); UA: actuator supply (green: OK)
Connections	
Fieldbus	via internal system connection
Sensor-system/actuator supply	via internal system connection (max. 1x4 A) / actuators via external cable (max. 4x2 A)
I/O ports	M12 (female) 5-pole, A-coded
Output	
Actuator supply UA	24 V DC (EN 61131-2), 2 circuits, (max. 2 x 4 A)
Switching current per output	max. 1.6 A (short-circuit and overload protected)
Diagnostic	
Communication status	via LED
Diagnostic via LED	per module and channel
Diagnostic via BUS	per module and channel
Monitoring - under voltage	yes
Monitoring - no voltage	yes
Short-circuit and overload	yes
Actuator warning	per channel via LED and BUS
General data	
Protection	IP67
Mounting method	2-hole screw mounting
Temperature range	0...+55 °C (storage temperature -20...+70 °C)
Dimension drawing	

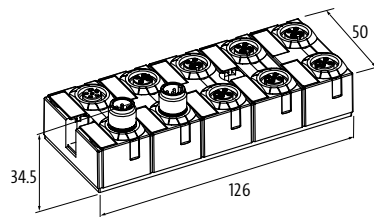

## Notes

## Function modules

– Hygienic Design

– multifunctional

– IP69K

IO-Link

## Cube67+ DIO12 IOL4 - E 8xM12 HD

Expansion module  
IO-Link Master



Order Data	Art-No.
DIO12/IOL4 - (E) 8xM12	5676660
Internal communication	
Current consumption	max. 100 mA
LED display	US: sensor supply (green: OK); IOL: (green: OK); UA: actuator supply (green: OK)
Connections	
Fieldbus	via internal system connection
Sensor-system/actuator supply	via internal system connection (max. 2x4 A)
I/O ports	M12 (female) 5-pole, A-coded
IO-Link	
IO-Link	4 x Master
Operating modes	COM1; COM2; COM3 (automatic)
Transfer parameters	32 Byte (via IO-Link Port)
Port class	Class A + B (not galvanically separated)
Specification	IO-Link Master V1.12
Input	
Sensor supply US	24 V DC (EN 61131-2), max. 200 mA (port 0...3); max. 700 mA (port 4...7)
Type	for 3-wire sensors or mechanical switches, PNP
Input filter	1 ms
Output	
Actuator supply UA	24 V DC (EN 61131-2), via system connection (max. 4 A)
Switching current per output	max. 1.6 A (short-circuit and overload protected)
Parameterization	
PIN 2	Input/Output/Diagnostic
PIN 4	Input/Output (port 0...3); IO-Link Master (port 4...7)
Diagnostic	
Communication status	via LED
Diagnostic via LED	per module and channel
Diagnostic via BUS	per module and channel
Monitoring - under voltage	yes
Monitoring - no voltage	yes
Short-circuit and overload	yes
Actuator warning	per channel via LED and BUS
General data	
Protection	IP69K
Mounting method	2-hole screw mounting
Temperature range	0...+55 °C (storage temperature -20...+75 °C)
Dimension drawing	

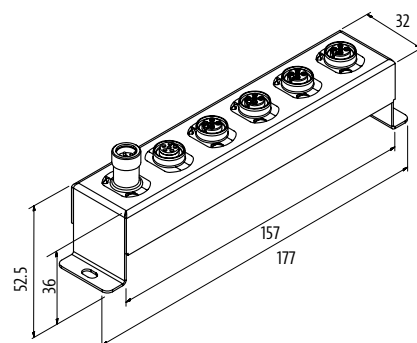

# CUBE67

## Hygienic Design

– multifunctional

– IP69K

### Cube67 DIO8 E - 4×M12 HD

Expansion module



### Cube67 DIO16 E - 8×M12 HD

Expansion module



Order Data	Art-No.	Art-No.
DIO8 - 0.5 A (E) 4×M12	5661160	
DIO16 - 0.5 A (E) 8×M12		5660160

#### Internal communication

Current consumption	max. 50 mA
LED display	US: sensor supply and internal supply voltage (green: OK); UA: actuator supply (green: OK)

#### Connections

Fieldbus	via internal system connection
Sensor-system/actuator supply	via internal system connection (max. 2×4 A)
I/O ports	M12 (female) 5-pole, A-coded

#### Input

Sensor supply US	24 V DC (EN 61131-2), max. 200 mA (M12 female), short-circuit and overload protected
Type	for 3-wire sensors or mechanical switches, PNP
Input filter	1 ms

#### Output

Actuator supply UA	24 V DC (EN 61131-2), via system connection (max. 4 A)
Switching current per output	max. 0.5 A (short-circuit and overload protected)

#### Parameterization

PIN 2	Input/Output/Diagnostic
PIN 4	Input/Output

#### Diagnostic

Communication status	via LED
Diagnostic via LED	per module and channel
Diagnostic via BUS	per module and channel
Monitoring - under voltage	yes
Monitoring - no voltage	yes
Short-circuit and overload	yes
Actuator warning	per channel via LED and BUS

#### General data

Protection	IP69K
Mounting method	2-hole screw mounting
Temperature range	0...+55 °C (storage temperature -20...+75 °C)

#### Dimension drawing

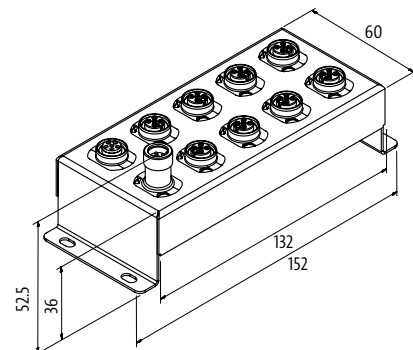
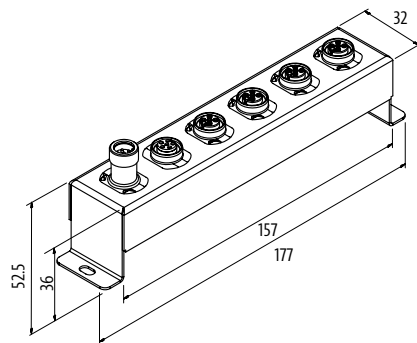

#### Notes



# CUBE67

## Digital outputs

– with open ended wires

### Cube67 DO8 - Valve

Expansion module

### Cube67 DO16 - E Valve

Expansion module

### Cube67 DO32 - E Valve

Expansion module



Approvals: UL Listed

Order Data	Art-No.	Art-No.	Art-No.
DO8 - 0.5 A (E) 0.5 m (open cable)	56655		
DO16 - 60 mA (E) 0.5 m (open cable)		56651	
DO32 - 0.5 A (E) 0.5 m (open cable)			56656
<b>Internal communication</b>			
Current consumption	max. 50 mA		
LED display	US: sensor supply and internal supply voltage (green: OK); UA: actuator supply (green: OK)		
<b>Connections</b>			
Fieldbus	via internal system connection		
Sensor-system/actuator supply	via internal system connection (max. 2x4 A)		
I/O ports	Open cable		
<b>Output</b>			
Actuator supply UA	24 V DC (EN 61131-2), via system connection (max. 4 A)		
Switching current per output	max. 0.5 A (short-circuit and overload protected)	max. 60 mA (short-circuit and overload protected)	max. 0.5 A (short-circuit and overload protected)
<b>Cables</b>			
No./diameter of wires	10 × 0.34 mm <sup>2</sup>	18 × 0.25 mm <sup>2</sup>	36 × 0.14 mm <sup>2</sup>
Material (jacket)	PUR	PVC	
Cable length	0.5 m		
<b>Diagnostic</b>			
Communication status	via LED		
Diagnostic via LED	per module		
Diagnostic via BUS	per module and channel		
Monitoring - under voltage	yes		
Monitoring - no voltage	yes		
Short-circuit and overload	yes		
Actuator warning	per channel via BUS		
<b>General data</b>			
Protection	IP67		
Mounting method	2-hole screw mounting		
Temperature range	0...+55 °C (storage temperature -20...+75 °C)		
<b>Dimension drawing</b>			

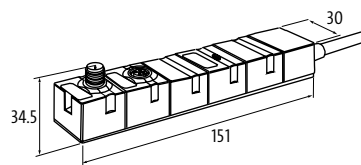

<b>Notes</b>
--------------

# CUBE67

## Digital inputs/outputs (multifunctional)

### Cube67 DIO8 E - Cable

Expansion module



Order Data	Art-No.	Art-No.
DIO8 - 60 mA (E) 0.5 m (open cable)	cUlus	56661
DIO8 - 60 mA (E) 2 m (open cable)		5666100
<b>Internal communication</b>		
Current consumption	max. 30 mA	
LED display	US: sensor supply and internal supply voltage (green: OK); UA: actuator supply (green: OK)	
<b>Connections</b>		
Fieldbus	via internal system connection	
Sensor-system/actuator supply	via internal system connection (max. 2x4 A)	
I/O ports	Open cable	
<b>Input</b>		
Sensor supply US	24 V DC (EN 61131-2), max. 1.6 A	
Type	for 3-wire sensors or mechanical switches, PNP	
Input filter	1 ms	
<b>Output</b>		
Actuator supply UA	24 V DC (EN 61131-2), via system connection (max. 4 A)	
Switching current per output	max. 60 mA (short-circuit and overload protected)	
<b>Cables</b>		
No./diameter of wires	10 × 0.34 mm <sup>2</sup>	
Material (jacket)	PVC	
Cable length	0.5 m	2.0 m
<b>Parameterization</b>		
I/O channels	Input/Output	
<b>Diagnostic</b>		
Communication status	via LED	
Diagnostic via LED	per module	
Diagnostic via BUS	per module and channel	
Monitoring - under voltage	yes	
Monitoring - no voltage	yes	
Short-circuit and overload	yes	
Actuator warning	per channel via BUS	
<b>General data</b>		
Protection	IP67	
Mounting method	2-hole screw mounting	
Temperature range	0...+55 °C (storage temperature -20...+75 °C)	
<b>Dimension drawing</b>		

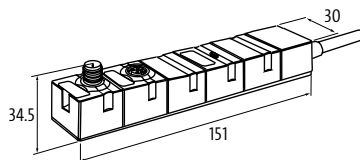

### Notes

# CUBE67

## Digital inputs/outputs (multifunctional)

### Cube67 DIO16 E - Cable

Expansion module

### Cube67 DI16 DO16 E - Cable

Expansion module



Order Data	Art-No.	Art-No.	Art-No.
DIO16 - 0.5 A (E) 0.5 m (open cable)	cULus	56662	
DIO16 - 0.5 A (E) 1.5 m (open cable)		5666200	
DI16/DO16 - 0.5 A (E) 0.5 m (open cable)			56671
<b>Internal communication</b>			
Current consumption	max. 30 mA		max. 50 mA
LED display	US: sensor supply and internal supply voltage (green: OK); UA: actuator supply (green: OK)		
<b>Connections</b>			
Fieldbus	via internal system connection		
Sensor-system/actuator supply	via internal system connection (max. 2x4 A)		
I/O ports	Open cable		
<b>Input</b>			
Sensor supply US	24 V DC (EN 61131-2), max. 0.5 A		24 V DC (EN 61131-2), max. 0.2 A
Type	for 3-wire sensors or mechanical switches, PNP		
Input filter	1 ms		
<b>Output</b>			
Actuator supply UA	24 V DC (EN 61131-2), via system connection (max. 4 A)		
Switching current per output	max. 0.5 A (short-circuit and overload protected)		
<b>Cables</b>			
No./diameter of wires	20 x 0.14 mm <sup>2</sup>		36 x 0.14 mm <sup>2</sup>
Material (jacket)	PVC		
Cable length	0.5 m	1.5 m	0.5 m
<b>Parameterization</b>			
I/O channels	Input/Output		-
<b>Diagnostic</b>			
Communication status	via LED		
Diagnostic via LED	per module		
Diagnostic via BUS	per module and channel		
Monitoring - under voltage	yes		
Monitoring - no voltage	yes		
Short-circuit and overload	yes		
Actuator warning	per channel via BUS		
<b>General data</b>			
Protection	IP67		
Mounting method	2-hole screw mounting		
Temperature range	0...+55 °C (storage temperature -20...+75 °C)		
<b>Dimension drawing</b>			

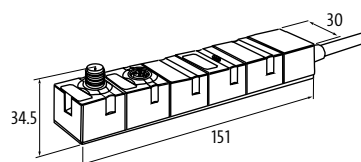

## Notes

# CUBE67

## Digital inputs/outputs (multifunctional)

### - Digital outputs

#### Cube67 DO7 - E Cable M12

for Modlight70 Pro basic  
Expansion module



#### Cube67 DIO8 E - Cable M12

Expansion module

#### Cube67 DIO8 - E M16 female

Expansion module



Order Data	Art-No.	Art-No.	Art-No.
DO7 - 0.5 A (E) 0.5 m (M12)	Modlight70 Pro - M12 (female) 8-pole <b>5665503</b>		
DIO8 - 60 mA (E) 0.5 m (M12)		cULus <b>5666201</b>	
DIO8 - 0.5 A (E) M16		cULus <b>56663</b>	
<b>Internal communication</b>			
Current consumption	max. 50 mA		max. 30 mA
LED display	US: sensor supply and internal supply voltage (green: OK); UA: actuator supply (green: OK)		
<b>Connections</b>			
Fieldbus	via internal system connection		
Sensor-system/actuator supply	via internal system connection (max. 2x4 A)		
I/O ports	Modlight70 Pro - M12 (female) 8-pole	M12 (male) 5-pole, A-coded	M16 (female)
<b>Input</b>			
Sensor supply US	–	24 V DC (EN 61131-2), max. 0.5 A	24 V DC (EN 61131-2), max. 200 mA
Type	–	for 3-wire sensors or mechanical switches, PNP	
Input filter	–	1 ms	
<b>Output</b>			
Actuator supply UA	24 V DC (EN 61131-2), via system connection (max. 4 A)		
Switching current per output	max. 0.5 A (short-circuit and overload protected)	max. 60 mA (short-circuit and overload protected)	max. 0.5 A (short-circuit and overload protected)
<b>Cables</b>			
No./diameter of wires	8 x 0.25 mm <sup>2</sup>		–
Material (jacket)	PUR		–
Cable length	0.5 m		–
<b>Parameterization</b>			
I/O channels	7 outputs	Input/Output	
<b>Diagnostic</b>			
Communication status	via LED		
Diagnostic via LED	per module		
Diagnostic via BUS	per module and channel		
Monitoring - under voltage	yes		
Monitoring - no voltage	yes		
Short-circuit and overload	yes		
Actuator warning	per channel via BUS		
<b>General data</b>			
Protection	IP67		
Mounting method	2-hole screw mounting		
Temperature range	0...+55 °C (storage temperature -20...+75 °C)		
<b>Dimension drawing</b>			
<b>Notes</b>			

# CUBE67

## Safe outputs (Safety)

- passive safety
- Output groups up to PLd (EN ISO 13849-1) can be switched off via safety relays

### Cube67 DO16 - C Valve (K3)

Compact module

### Cube67 DO8 - C Valve (K3)

Compact module



Order Data	Art-No.	Art-No.
DO16 - 0.5 A Valve (C) 0.5 m (K3)	FESTO - CPV (SUB-D25) – cULus	<b>56650</b>
DO8 - 0.5 A Valve (C) 0.5 m (K3)		FESTO - CPV (SUB-D9) <b>5665003</b>
<b>Internal communication</b>		
Current consumption	max. 50 mA	
LED display	US: sensor supply and internal supply voltage (green: OK); UA: actuator supply (green: OK)	
<b>Connections</b>		
Fieldbus	via internal system connection	
Sensor-system/actuator supply	via internal system connection (max. 1x4 A) / actuators via external cable (max. 4x2 A)	
I/O ports	FESTO - CPV (SUB-D25)	FESTO - CPV (SUB-D9)
<b>Output</b>		
Actuator supply UA	24 V DC (EN 61131-2), max. 4 x 2 A	
Switching current per output	max. 0.5 A (short-circuit and overload protected)	
<b>Cables</b>		
No./diameter of wires	4x4x0.14 mm <sup>2</sup>	
Material (jacket)	PVC, cross-link safe	
Cable length	0.5 m	
<b>Diagnostic</b>		
Communication status	via LED	
Diagnostic via LED	per module	
Diagnostic via BUS	per module and channel	
Monitoring - under voltage	yes	
Monitoring - no voltage	yes	
Short-circuit and overload	yes	
Actuator warning	per channel via BUS	
<b>General data</b>		
Protection	IP67	
Mounting method	2-hole screw mounting	
Temperature range	0...+55 °C (storage temperature -20...+70 °C)	
<b>Dimension drawing</b>		

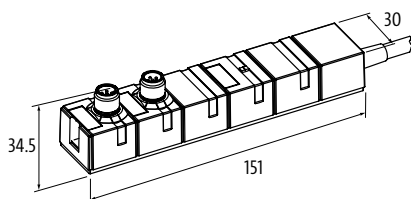

Notes

# CUBE67

## Digital outputs

### Cube67 DO16 - C Valve

Compact module  
(4 × actuator supply UA)



### Cube67 DO32 - E Valve

Expansion module



### Cube67 DO16 - E Valve











Expansion module

Order Data	Art-No.	Art-No.	Art-No.
DO16 - 0.5 A Valve (C) 0.5 m	SMC - SUB-D25 SMC - Series SV/VQ FESTO - MPA (SUB-D25) FESTO - CPV (SUB-D25)	5665000 5665002 5665001 5665004	
DO32 - 0.5 A Valve (E)		MAC - SUB-D44	56657
DO16 - 0.5 A Valve (E)			MAC - SUB-D44 56653
<b>Internal communication</b>			
Current consumption	max. 50 mA		
LED display	US: sensor supply and internal supply voltage (green: OK); UA: actuator supply (green: OK)		
<b>Connections</b>			
Fieldbus	via internal system connection		
Sensor-system/actuator supply	via internal system connection (max. 1×4 A) / actuators via external cable (max. 4×2 A)	via internal system connection (max. 2×4 A)	
I/O ports	SMC - SUB-D25	MAC - SUB-D44	
<b>Output</b>			
Actuator supply UA	24 V DC (EN 61131-2), max. 4 × 2 A	24 V DC (EN 61131-2)	
Switching current per output	max. 0.5 A (short-circuit and overload protected)		
<b>Cables</b>			
No./diameter of wires	4×4×0.14 mm <sup>2</sup>	–	
Material (jacket)	PVC, cross-link safe	–	
Cable length	0.5 m	–	
<b>Diagnostic</b>			
Communication status	via LED		
Diagnostic via LED	per module		
Diagnostic via BUS	per module and channel		
Monitoring - under voltage	yes		
Monitoring - no voltage	yes		
Short-circuit and overload	yes		
Actuator warning	per channel via BUS		
<b>General data</b>			
Protection	IP67		
Mounting method	2-hole screw mounting		
Temperature range	0...+55 °C (storage temperature -20...+70 °C)		
<b>Dimension drawing</b>			
<b>Notes</b>			

Versions			Art-No.
	<b>based of: Art.-No. 56655</b>		
	Multipole plug (70 mA)	FESTO - CPV	5665500
	Multipole plug (70 mA)	FESTO - CPV (SUB-D9)	5665501
	Multipole plug (0.5 A)	FESTO - MPA	5665502
	<b>based of: Art.-No. 56651</b>		
	Multipole plug (70 mA)	SMC - Series SV/VQ	5665119
	Multipole plug (0.5 A)	SMC - Series SV/VQ	5665120
	Multipole plug (0.5 A)	FESTO - CPV-VA (SUB-D25)	5665151
	<b>based of: Art.-No. 56651</b>		
	Multipole plug (70 mA)	FESTO - CPV (cULus-Listed)	5665100
	Multipole plug (70 mA)	PARKER - Series V	5665101
	Multipole plug (70 mA)	NORGREN - V20/22	5665110
	Multipole plug (70 mA)	NORGREN - VM10	5665111
	Multipole plug (70 mA)	NORGREN - V20/22	5665112
	Multipole plug (70 mA)	SMC - Series SV/VQ	5665113
	Multipole plug (70 mA)	SMC - M27	5665114
	Multipole plug (70 mA)	NORGREN - V20/220	5665115
	Multipole plug (0.5 A)	MAC Valves	5665116
	Multipole plug (70 mA)	FESTO - MPA	5665118
	Multipole plug (70 mA)	FESTO - VTSA	5665105
	Multipole plug (70 mA)	FESTO - CPV-SC (SUB-D15)	5665102
	Multipole plug (70 mA)	FESTO - CPV-SC (SUB-D26)	5665103
	Multipole plug (0.5 A)	HDM (SUB-D25)	5665106
	<b>based of: Art.-No. 56656</b>		
	Multipole plug (0.5 A)	NORGREN - VM10	5665600
	Multipole plug (0.5 A)	FESTO - MPA	5665601
	Multipole plug (0.5 A)	AVENTICS - HF03	5665602
	Multipole plug (0.5 A)	NORGREN - VM10	5665603
	Multipole plug (0.5 A)	SMC - Series SV	5665604
	Multipole plug (0.5 A)	FESTO - CPA	5665605
	Multipole plug (0.5 A)	AVENTICS - HF04	5665621
	Multipole plug (0.5 A)	AVENTICS - HF02/03-LG	5665606
	Multipole plug (0.5 A)	SMC - M27	5665607
	Multipole plug (0.5 A)	MAC Valves (UL-Listed)	5665609
	Multipole plug (0.5 A)	VESTA (SUB-D37)	5665610
	Multipole plug (0.5 A)	VESTA (SUB-D25)	5665611
	Multipole plug (0.5 A)	FESTO - VTSA	5665613
	Multipole plug (0.5 A)	SMC - SUB-D25	5665614
	Multipole plug (0.5 A)	FESTO - CPA-SC	5665615
	Multipole plug (0.5 A)	FESTO - MPA-L	5665616
	Multipole plug (0.5 A)	AVENTICS - HF02/03-LG	5665617
	Multipole plug (0.5 A)	Numatics Generation 2000 (UL-Listed)	5665618
	Multipole plug (0.5 A)	FESTO - MPA-L	5665619
	<b>based of: Art.-No. 56671</b>		
	DI16/DO16 - 0.5 A (E) AMP (0.5 m)	with AMP connector 32-pole (female)	5667100
	DI16/DO16 - 0.5 A (E) SUB-D37 (0.5 m)	with SUB-D37 (female)	5667101
	DI16/DO16 - 0.5 A (E) SUB-D37 (5 m)	with SUB-D37 (female)	5667102
	DI16/DO16 - 0.5 A E (0.72 m)	with open ended wires	5667103
	DI16/DO16 - 0.5 A E (2 m)	with open ended wires	5667104
	DI16/DO16 - 0.5 A E (3 m)	with open ended wires	5667106
	DI16/DO16 - 0.5 A E (5 m)	with open ended wires	5667105

# CUBE67

Cube67

Labeling accessories			Art-No.
	<b>Label plates</b> 20 × 8 mm	(20 pieces per plate)	<b>55318</b>
	<b>Label plates 20 × 8 mm</b> (20 pieces per plate)	Safety	<b>55316</b>
Blind Plug/caps			Art-No.
	<b>Screw plug M8 × 1 mm (for female)</b> Plastic, hex without gasket	Quantity: 10 pcs.	<b>3858627</b>
	<b>Screw plug M12 × 1 mm (for female)</b> Plastic, hex without gasket	Quantity: 10 pcs.	<b>58627</b>
	Plastic, hex without gasket	Quantity: 4 pcs.	<b>56952</b>
	<b>Screw plug M12 × 1 mm (for male)</b> Plastic	Quantity: 4 pcs.	<b>56951</b>
	<b>Screw plug 7/8" (for male)</b> Plastic		<b>55385</b>
	<b>Blind plug diagnostic M12 × 1 mm</b> Bridge PIN 1 and PIN 2		<b>7000-13481-0000000</b>
Connection accessories			Art-No.
	<b>Ground strap 4 mm²</b> 100 mm for screw (M4)		<b>4000-71001-0410004</b>
	<b>T-coupler M12 – M12</b> Male straight - female straight straight, A-coded, 6-pole, shielded	Cube67 additional actuator power supply	<b>7000-46101-0000000</b>
	<b>T-coupler M12/M12, female/male</b> straight, A-coded, 6-pole, shielded	Cube67 additional actuator power supply	<b>7000-46091-0000000</b>



Connection accessories			Art-No.
	<p><b>T-coupler 7/8"-7/8", female/male</b> 5-pole</p>		7000-50061-0000000
	<p><b>Terminator M12 (male)</b> straight, A-coded, 6-pole</p>	Cube67	7000-15041-0000000
	<p><b>Control cabinet entry system M12</b> straight, A-coded, 6-pole, shielded</p>	Cube67	7000-46111-0000000
	<p><b>Cube67 FSC Connector Set</b> with mounting socket Han-Brid®, 6-pole - M12, 6-pole</p>	Cable length (120 mm)	56953
	<p><b>DIN-rail adapter</b></p>	for bus nodes	56961
	<p><b>DIN-rail adapter</b> for extension modules</p>	50 mm	56962
	<p><b>DIN-rail adapter</b> for extension modules</p>	30 mm	56963
	<p><b>Power distributor 4 x M12</b> for additional actuator supply</p>		56955
	<p><b>Repeater PROFIBUS DP + PROFIsafe</b> 2 segments 3 segments</p>		56960 56965

# CUBE67

Cube67

Connection accessories			Art-No.
	<p><b>Male M12, field-wireable, screw terminals</b> Analog input with integrated compensation</p>	Cube67	56945
	<p><b>Male M12, field-wireable, screw terminals</b> Analog input with integrated compensation</p>	Cube67	56946
	<p><b>Male M12</b> Internal system connection</p>		56947
	<p><b>Female M12</b> Internal system connection with mounting socket</p>		56948
	<p><b>Female M12</b> Internal system connection</p>		56949

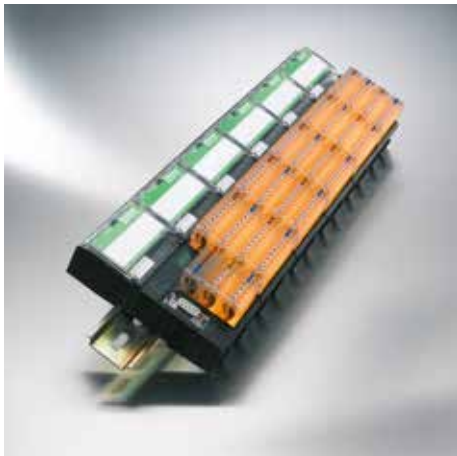

# CUBE20 MODULAR I/O STATION IP20

- High channel density due to compact design
- Modular structure
- I/O connections with maintenance-free terminals







## INNOVATIVE INSTALLATION TECHNOLOGY

Cube20 is an expandable modular fieldbus I/O system for control cabinets. It can be operated as a stand-alone unit or with a Cube67. Cube20 is consistently designed for the requirements of modern control cabinet wiring. High costs due to handling of many individual components can be reduced to a minimum with Cube20.



EtherNet/IP

## Cube20 I/O Modules

 <p><b>Bus nodes</b></p> <ul style="list-style-type: none"> <li>• PROFIBUS DP</li> <li>• PROFINET IO</li> <li>• EtherNet/IP</li> </ul> <p><i>Page 4.2.1</i></p>	 <p><b>System connection to Cube67</b></p> <p><i>Page 4.2.3</i></p>
 <p><b>Digital inputs</b></p> <p><i>Page 4.2.5</i></p>	 <p><b>Digital inputs/outputs</b></p> <p><i>Page 4.2.5</i></p>
 <p><b>Digital outputs</b></p> <p><i>Page 4.2.6</i></p>	 <p><b>Analog inputs</b></p> <p><i>Page 4.2.8</i></p>
 <p><b>Analog outputs</b></p> <p><i>Page 4.2.10</i></p>	

# CUBE20

## Bus Nodes

### – Digital inputs



### Cube20 BN-P DI8

PROFIBUS DP



### Cube20 BN-PNIO DI8

PROFINET IO



Order Data	Art-No.	Art-No.
PROFIBUS DP	<b>56001</b>	
PROFINET IO		<b>56006</b>
<b>Connections</b>		
Fieldbus	PROFIBUS 12 Mbit/s; SUB-D9	Ethernet 10/100 Mbit/s; 2 × RJ45 (female)
Sensor-system/actuator supply	4 × Spring clamp plug-in terminals, max. 2.5 mm <sup>2</sup> (max. 12 A)	
Internal system connection	4 × Spring clamp plug-in terminals, max. 2.5 mm <sup>2</sup> (max. 12 A)	
I/O ports	8 × Spring clamp plug-in terminals, max. 2.5 mm <sup>2</sup>	
<b>Module Supply</b>		
Operating voltage	24 V DC (EN 61131-2)	
Current consumption	max. 150 mA	
<b>PROFIBUS</b>		
Addressing	Rotary switch 0...99	–
<b>PROFINET</b>		
Addressing	–	DCP
Specification	–	V2.2, Conformance Class B
<b>Cube system</b>		
Module capacity	max. 15	
I/O capacity	max. 244 Byte (Input), max. 244 Byte (Output)	max. 1024 Byte (Input), max. 1024 Byte (Output)
Machine Option Management	yes	
<b>Input</b>		
Sensor supply US	24 V DC (EN 61131-2), max. 700 mA per module	
Type	PNP (EN 61131-2)	
Input filter	1 ms	
Galvanic isolation	500 V DC between I/O and system electronics	
<b>Parameterization</b>		
Terminal row X2 (4 channels)	Input	
Terminal row X3 (4 channels)	Input	
<b>Diagnostic</b>		
Communication status	via LED and BUS	
Diagnostic via LED	per module	
Diagnostic via BUS	per module and channel	
Monitoring - under voltage	yes	
Monitoring - no voltage	no	
Short circuit and overload	yes	
<b>General data</b>		
Protection	IP20	
Mounting method	DIN-rail mountable (EN 60715)	
Temperature range	0...+55 °C (storage temperature -20...+85 °C)	

### Dimension drawing

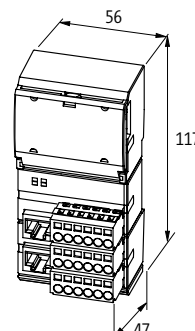
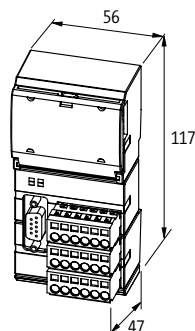

# CUBE20

## Bus Nodes

– Digital inputs

EtherNet/IP

## Cube20 BN-E DI8

EtherNet/IP



Approvals:  Listed

Order Data	Art-No.
EtherNet/IP	56005
Connections	
Fieldbus	Ethernet 10/100 Mbit/s; 2 × RJ45 (female)
Sensor-system/actuator supply	4 × Spring clamp plug-in terminals, max. 2.5 mm <sup>2</sup> (max. 12 A)
Internal system connection	4 × Spring clamp plug-in terminals, max. 2.5 mm <sup>2</sup> (max. 12 A)
I/O ports	8 × Spring clamp plug-in terminals, max. 2.5 mm <sup>2</sup>
Module Supply	
Operating voltage	24 V DC (EN 61131-2)
Current consumption	max. 150 mA
EtherNet/IP	
Addressing	DHCP, BOOTP or IP address by rotary switch
Cube system	
Module capacity	max. 15
I/O capacity	max. 504 Byte (Input), max. 500 Byte (Output)
Input	
Sensor supply US	24 V DC (EN 61131-2), max. 700 mA per module
Type	PNP (EN 61131-2)
Input filter	1 ms
Galvanic isolation	500 V DC between I/O and system electronics
Parameterization	
Terminal row X2 (4 channels)	Input
Terminal row X3 (4 channels)	Input
Diagnostic	
Communication status	via LED and BUS
Diagnostic via LED	per module
Diagnostic via BUS	per module and channel
Monitoring - under voltage	yes
Monitoring - no voltage	no
Short circuit and overload	yes
General data	
Protection	IP20
Mounting method	DIN-rail mountable (EN 60715)
Temperature range	0...+55 °C (storage temperature -20...+85 °C)
Dimension drawing	

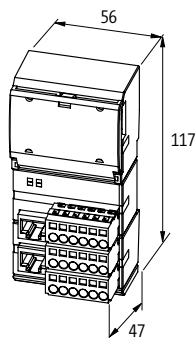

## Notes

# CUBE20

## Cube20/67-Interface

– Digital inputs/outputs  
(multifunctional)

– Cube67

Approvals:  UL  
Listed

## Cube20 BN-67 DIO8

Power external



## Cube20 BN-67 DIO8

M12 Power  
via internal system connection

Order Data	Art-No.	Art-No.
Cube67 system connection	<b>56450</b>	<b>564501</b>
<b>Connections</b>		
Fieldbus	M12 (male) 6-pole	M12 (female) 6-pole
Sensor-system/actuator supply	4 × Spring clamp plug-in terminals, max. 2.5 mm <sup>2</sup> (max. 12 A)	via internal system connection (max. 2×4 A)
I/O ports	8 × Spring clamp plug-in terminals, max. 2.5 mm <sup>2</sup>	
<b>Module Supply</b>		
Operating voltage	24 V DC (EN 61131-2)	
Current consumption	max. 100 mA	
<b>Cube system</b>		
Module capacity	max. 3	
<b>Input</b>		
Sensor supply US	24 V DC (EN 61131-2), max. 700 mA per module, short-circuit and overload protected	
Type	PNP (EN 61131-2)	
Input filter	1 ms	
Galvanic isolation	500 V DC between I/O and system electronics	
<b>Output</b>		
Actuator supply UA	24 V DC (EN 61131-2), max. 12 A	24 V DC (EN 61131-2), max. 4 A
Switching current per output	max. 0.5 A (short-circuit and overload protected)	
Galvanic isolation	500 V DC between I/O and system electronics	
Lamp load	10 W	
<b>Parameterization</b>		
Terminal row X2 (4 channels)	Input/Output	
Terminal row X3 (4 channels)	Input/Output	
<b>Diagnostic</b>		
Communication status	via LED	
Diagnostic via LED	per module and channel (only outputs)	
Diagnostic via BUS	per module and channel	
Monitoring - under voltage	yes	
Monitoring - no voltage	no	
Short circuit and overload	yes	
<b>General data</b>		
Protection	IP20	
Mounting method	DIN-rail mountable (EN 60715)	
Temperature range	0...+55 °C (storage temperature -20...+85 °C)	
<b>Dimension drawing</b>		

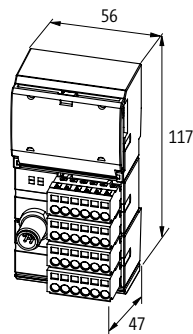

Notes

# CUBE20

## Cube20/67-Interface

– Cube67

## Cube20/67-Interface



Approvals:  UL US  
Listed

Order Data	Art-No.
Cube67 system connection	56140
Connections	
Fieldbus	M12 (female) 6-pole
Sensor-system/actuator supply	4 × Spring clamp plug-in terminals, max. 2.5 mm <sup>2</sup> (max. 12 A)
I/O ports	8 × Spring clamp plug-in terminals, max. 2.5 mm <sup>2</sup>
Module Supply	
Operating voltage	24 V DC (EN 61131-2)
Current consumption	max. 25 mA
Cube system	
Module capacity	max. 15
Sensor supply US	24 V DC (18...30.2 V DC) EN 61131-2, max. 4 A
Actuator supply UA	24 V DC (18...30.2 V DC) EN 61131-2, max. 4 A
Diagnostic	
Communication status	via LED
General data	
Protection	IP20
Mounting method	DIN-rail mountable (EN 60715)
Temperature range	0...+55 °C (storage temperature -20...+85 °C)
Dimension drawing	

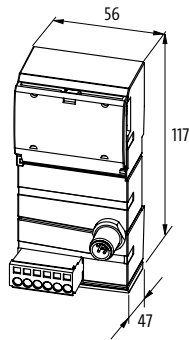

## Notes

# CUBE20

## Digital inputs/outputs

**Cube20 DI32 E**  
Expansion module



**Cube20 DI16 DO16 E**  
Expansion module



Order Data	Art-No.	Art-No.
DI32 - (E)	cULus	<b>56112</b>
DI16/DO16 - (E)		<b>56168</b>
<b>Internal communication</b>		
Module Supply	via system connection	
Current consumption	max. 25 mA	
<b>Connections</b>		
Fieldbus	Ribbon cable connection	
Sensor-system/actuator supply	8 × Spring clamp plug-in terminals, max. 2.5 mm <sup>2</sup> (max. 12 A)	
I/O ports	32 × Spring clamp plug-in terminals, max. 2.5 mm <sup>2</sup>	
<b>Input</b>		
Sensor supply US	24 V DC (EN 61131-2), max. 700 mA per module	
Type	PNP (EN 61131-2)	
Input filter	1 ms	
Galvanic isolation	500 V DC between inputs and internal communication	
<b>Output</b>		
Actuator supply UA	–	24 V DC (EN 61131-2), max. 12 A
Galvanic isolation	–	500 V DC between outputs and internal communication
Switching current per output	–	max. 0.5 A (short-circuit and overload protected)
Lamp load	–	10 W
<b>Diagnostic</b>		
Communication status	via LED	
Diagnostic via LED	per module	per module and channel (only outputs)
Diagnostic via BUS	per module and channel	
Monitoring - under voltage	yes	
Monitoring - no voltage	no	
Short circuit and overload	yes	
<b>General data</b>		
Protection	IP20	
Mounting method	DIN-rail mountable (EN 60715)	
Temperature range	0...+55 °C (storage temperature -20...+85 °C)	

**Dimension drawing**

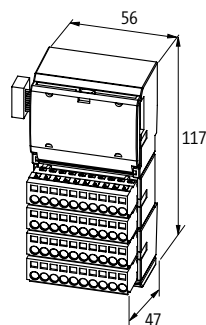

Notes



# CUBE20

## Digital outputs

### Cube20 DO16 E - 2 A

Expansion module



Approvals:  Listed

Order Data	Art-No.
DO16 - 2 A (E)	56117
Internal communication	
Module Supply	via system connection
Current consumption	max. 25 mA
Connections	
Fieldbus	Ribbon cable connection
Sensor-system/actuator supply	8 × Spring clamp plug-in terminals, max. 2.5 mm <sup>2</sup> (max. 12 A)
I/O ports	16 × Spring clamp plug-in terminals, max. 2.5 mm <sup>2</sup>
Output	
Actuator supply UA	24 V DC (EN 61131-2), max. 12 A
Switching current per output	max. 2 A
Galvanic isolation	500 V DC between outputs and internal communication
Lamp load	40 W
Diagnostic	
Communication status	via LED
Diagnostic via LED	per module and channel
Diagnostic via BUS	per module and channel
Monitoring - under voltage	yes
Monitoring - no voltage	no
Short circuit and overload	yes
General data	
Protection	IP20
Mounting method	DIN-rail mountable (EN 60715)
Temperature range	0...+55 °C (storage temperature -20...+85 °C)
Dimension drawing	

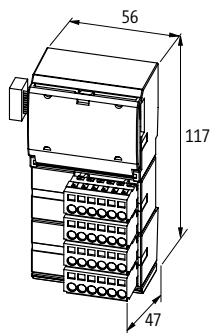

## Notes

# CUBE20

## Digital outputs

### Cube20 DO32 E Expansion module



Approvals:  UL  
Listed

Cube20

Order Data		Art-No.
DO32 - (E)		56118
Internal communication		
Module Supply	via system connection	
Current consumption	max. 25 mA	
Connections		
Fieldbus	Ribbon cable connection	
Sensor-system/actuator supply	8 × Spring clamp plug-in terminals, max. 2.5 mm <sup>2</sup> (max. 12 A)	
I/O ports	32 × Spring clamp plug-in terminals, max. 2.5 mm <sup>2</sup>	
Output		
Actuator supply UA	24 V DC (EN 61131-2), max. 12 A	
Switching current per output	max. 0.5 A (short-circuit and overload protected)	
Galvanic isolation	500 V DC between outputs and internal communication	
Lamp load	10 W	
Diagnostic		
Communication status	via LED	
Diagnostic via LED	per module and channel	
Diagnostic via BUS	per module and channel	
Monitoring - under voltage	yes	
Monitoring - no voltage	no	
Short circuit and overload	yes	
General data		
Protection	IP20	
Mounting method	DIN-rail mountable (EN 60715)	
Temperature range	0...+55 °C (storage temperature -20...+85 °C)	
Dimension drawing		

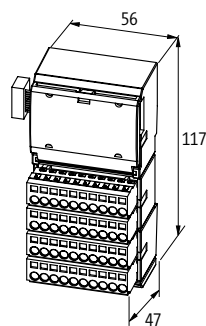

Notes

# CUBE20

## Analog inputs

### – Voltage/current

#### Cube20 AI4 E

Expansion module  
Voltage/current



Approvals:  Listed

Order Data	Art-No.
AI4 - (E)	56200
Internal communication	
Module Supply	via system connection
Current consumption	max. 25 mA from system, max. 60 mA externally (UI)
Connections	
Fieldbus	Ribbon cable connection
Sensor-system/actuator supply	4 × Spring clamp plug-in terminals, max. 2.5 mm <sup>2</sup> (max. 12 A)
I/O ports	24 × Spring clamp plug-in terminals, max. 2.5 mm <sup>2</sup>
Input	
Conversion time (analog)	max. 2 ms (per channel)
Resolution (analog)	15 Bit + sign
Accuracy	max. 0.3%
Connection	Differential voltage/current input
Voltage inputs	
Input resistor	min. 1 MOhm, (EN 61131-2)
Input range	±10 V DC, 0...10 V DC
Current input signals	
Load	max. 300 Ohm (20 mA), (EN 61131-2)
Input range	0...20 mA, 4...20 mA
Diagnostic	
Communication status	via LED
Diagnostic via LED	per module
Diagnostic via BUS	per module and channel
Monitoring - under voltage	yes
Monitoring - no voltage	no
Short circuit and overload	yes
Wire break upper/lower limit overload	per channel via LED and BUS
General data	
Protection	IP20
Mounting method	DIN-rail mountable (EN 60715)
Temperature range	0...+55 °C (storage temperature -40...+85 °C)
Dimension drawing	

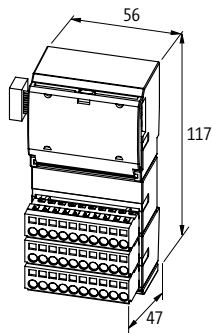

## Notes

# CUBE20

## Analog inputs

### – Temperature converter

#### Cube20 AI4 E RTD

Expansion module  
for resistors and temperature



#### Cube20 AI4 E TH

Expansion module  
for thermo elements



Approvals:  **UL** us  
Listed

Order Data	Art-No.	Art-No.
AI4 - (E) RTD	<b>56230</b>	
AI4 - (E) TH		<b>56240</b>
<b>Internal communication</b>		
Module Supply	via system connection	
Current consumption	max. 25 mA from system, max. 70 mA externally (UI)	max. 25 mA from system, max. 45 mA externally (UI)
<b>Connections</b>		
Fieldbus	Ribbon cable connection	
Sensor-system/actuator supply	4 × Spring clamp plug-in terminals, max. 2.5 mm <sup>2</sup> (max. 12 A)	
I/O ports	16 × Spring clamp plug-in terminals, max. 2.5 mm <sup>2</sup>	12 × Spring clamp plug-in terminals, max. 2.5 mm <sup>2</sup>
<b>Input</b>		
Conversion time (analog)	max. 600 ms (per channel)	max. 300 ms (per channel)
Type	Pt100, 200, 500; Ni100, 120, 200, 500, 1000, R 0...3000 Ohm	K, N, E, J, R
Resolution (analog)	15 Bit + sign	
Accuracy	0.7...1.4%	max. ±2%, cold junction compensation
Connection	2-wire input: +Rx, -Rx / 3-wire input: +Rx, RLx, -Rx	2-wire input; TH+x, TH-x
<b>Diagnostic</b>		
Communication status	via LED	
Diagnostic via LED	per module	
Diagnostic via BUS	per module and channel	
Monitoring - under voltage	yes	
Monitoring - no voltage	no	
Short circuit and overload	yes	
Wire break upper/lower limit overload	per channel via LED and BUS	
<b>General data</b>		
Protection	IP20	
Mounting method	DIN-rail mountable (EN 60715)	
Temperature range	0...+55 °C (storage temperature -20...+85 °C)	
<b>Dimension drawing</b>		

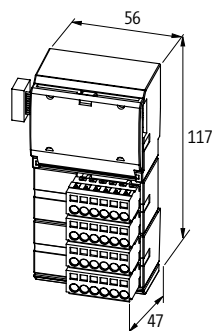

Notes

# CUBE20

## Analog outputs

### – Voltage/current

#### Cube20 AO4 E

Expansion module  
Voltage/current



Approvals:  Listed

Order Data	Art-No.
AO4 - (E) U/I	56220
Internal communication	
Module Supply	via system connection
Current consumption	max. 25 mA from system, max. 90 mA externally (UI), idle load
Connections	
Fieldbus	Ribbon cable connection
Sensor-system/actuator supply	4 × Spring clamp plug-in terminals, max. 2.5 mm <sup>2</sup> (max. 12 A)
I/O ports	24 × Spring clamp plug-in terminals, max. 2.5 mm <sup>2</sup>
Output	
Conversion time (analog)	max. 1 ms (per channel)
Resolution (analog)	15 Bit + sign
Accuracy	max. 0.5%
Galvanic isolation	500 V DC between inputs and internal communication
Voltage output signals	
Load	min. 1 kOhm, (EN 61131-2)
Input range	±10 V DC, 0...10 V DC
Current outputs	
Load	max. 60 Ohm, (EN 61131-2)
Input range	0...20 mA, 4...20 mA
Diagnostic	
Communication status	via LED
Diagnostic via LED	per module and channel
Diagnostic via BUS	per module and channel
Monitoring - under voltage	yes
Monitoring - no voltage	no
Short circuit and overload	yes
Actuator warning	per channel via LED and BUS
Wire break upper/lower limit overload	per channel via LED and BUS
General data	
Protection	IP20
Mounting method	DIN-rail mountable (EN 60715)
Temperature range	0...+55 °C (storage temperature -20...+85 °C)
Dimension drawing	

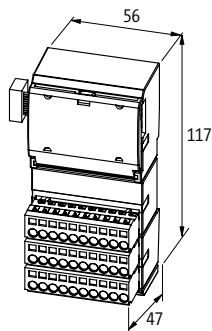

## Notes

Connection accessories			Art-No.
	<b>Bus Connection Plug 90°</b> SUB-D9 (male), screw terminals	PROFIBUS	55762
	SUB-D9 (female), screw terminals	CANopen	55760
	<b>Bus Connection Plug 180°</b> SUB-D9 (male), IDC terminals, rigid cable	PROFIBUS	55584
	SUB-D9 (male), IDC terminals, flexible cable	PROFIBUS	55583
	<b>Bus Connection Plug 90°</b> SUB-D9 (male), IDC terminals, rigid cable	PROFIBUS	55585
	SUB-D9 (male), IDC terminals, flexible cable	PROFIBUS	55587
	<b>Bus Connection Plug 90°</b> SUB-D9 (male), IDC terminals, rigid cable, programming device conn.	PROFIBUS	55586
	SUB-D9 (male), IDC terminals, flexible cable, programming device conn.	PROFIBUS	55588
	<b>Bus Connection Plug 90°</b> SUB-D9 (male); M12 × 1, B-coded	PROFIBUS	7000-99441-0000000
	<b>Label-sheet</b> Quantity: 40 pcs.		56113
	<b>Potential terminal block</b> gray/gray/brown/blue		56078
	gray/gray/yellow/blue		56079
	yellow/blue/yellow/blue		56080
	brown/blue/brown/blue		56081
	blue/yellow/brown/blue		56111
	gray/gray/gray/gray		56084
	blue/blue/blue/blue		56085
	brown/brown/brown/brown		56077
	brown/brown/blue/blue		56109
	blue/yellow		56110

# CUBE20

## Connection accessories

Art-No.



**Potential terminal block**

Multi color

56083



**Potential terminal block**

Slim Line

56082

Cube20



# CUBE20S

## SMALL, SPEEDY, SAFE

- Extremely modular
- Up to 64 modules per bus node
- Quick reaction time: up to 20  $\mu$ s

### A MEMBER OF THE CUBE-FAMILY

Murrelektronik's modular Cube20S I/O system expands the field-tested Cube family with another product line that is extremely useful.

The compact modules are only 12.9 millimeters wide and have modular design, allowing them to be installed in series easily, quickly and according to individual requirements – the integrated backplane bus connects the modules to energy and data.

Bus nodes for Cube20S are available for standard fieldbus protocols.



### Cube20S I/O Modules

 <p><b>Bus nodes/Power modules</b></p> <p><i>Page 4.3.1</i></p>	 <p><b>Supply module</b></p> <p><i>Page 4.3.4</i></p>
 <p><b>Digital inputs</b></p> <p><i>Page 4.3.6</i></p>	 <p><b>Digital outputs</b></p> <p><i>Page 4.3.8</i></p>
 <p><b>Analog inputs</b></p> <p><i>Page 4.3.11</i></p>	 <p><b>Analog outputs</b></p> <p><i>Page 4.3.13</i></p>
 <p><b>Safety modules</b></p> <ul style="list-style-type: none"> <li>• Digital inputs</li> <li>• Digital outputs</li> </ul>  <p><i>Page 4.3.7/4.3.10</i></p>	



# CUBE20S

## Bus Nodes

– Power module included



Approvals: UL Listed

## Cube20S



## Cube20S



Order Data	Art-No.	Art-No.
PROFIBUS DP	57101	
PROFINET IO		57106
<b>Connections</b>		
Fieldbus	PROFIBUS 12 Mbit/s; SUB-D9	Ethernet 10/100 Mbit/s; 2 × RJ45 (female)
Internal system connection	4 × Spring clamp plug-in terminals, max. 1.5 mm <sup>2</sup> (max. 10 A)	
Sensor-system/actuator supply	4 × Spring clamp plug-in terminals, max. 1.5 mm <sup>2</sup> (max. 10 A)	
<b>Module supply</b>		
Operating voltage	24 V DC (EN 61131-2)	
Current consumption	max. 95 mA	
<b>PROFIBUS</b>		
Addressing	Address switch 1...125	–
<b>PROFINET</b>		
Addressing	–	DCP
Shared Device/Input	–	yes, for 3 controls
Specification	–	V2.2, Conformance Class B
MRP	–	yes
<b>Cube system</b>		
Module capacity	max. 64	
I/O capacity	max. 244 Byte (Input), max. 244 Byte (Output)	max. 512 Byte (Input), max. 512 Byte (Output)
Machine Option Management	–	yes
<b>Output</b>		
Output voltage (I/Os /Backplane)	24 V DC/5 V DC	
Output current (I/Os /Backplane)	10 A/3 A	
<b>Diagnostic</b>		
Communication status	via LED	
Diagnostic via LED	per module and channel	
Diagnostic via BUS	per module	
Monitoring - under voltage	no	
Monitoring - no voltage	yes	
Short circuit and overload	yes	
Actuator warning	no	
<b>General data</b>		
Protection	IP20	
Connection	Spring clamp plug-in terminals: max. 1.5 mm <sup>2</sup> (max. 10 A)	
Mounting method	DIN-rail mountable (EN 60715)	
Temperature range	0...+60 °C (storage temperature -25...+70 °C)	
<b>Dimension drawing</b>		

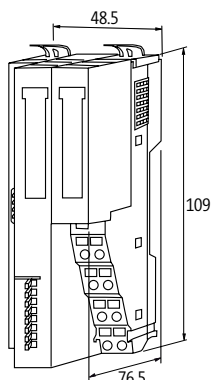

# CUBE20S

## Bus Nodes

– Power module included

EtherNet/IP EtherCAT

## Cube20S



Approvals:  Listed

Order Data	Art-No.	Art-No.
EtherNet/IP	57105	
EtherCAT		57103
<b>Connections</b>		
Fieldbus	Ethernet 10/100 Mbit/s; 1 × RJ45 (female)	Ethernet 10/100 Mbit/s; 2 × RJ45 (female)
Internal system connection	4 × Spring clamp plug-in terminals, max. 1.5 mm <sup>2</sup> (max. 10 A)	
Sensor-system/actuator supply	4 × Spring clamp plug-in terminals, max. 1.5 mm <sup>2</sup> (max. 10 A)	
<b>Module supply</b>		
Operating voltage	24 V DC (EN 61131-2)	
Current consumption	max. 95 mA	
<b>EtherNet/IP</b>		
Addressing	DHCP, BOOTP or IP address by rotary switch	–
<b>EtherCAT</b>		
Addressing	–	automatic
Operating modes	–	FreeRun, SyncManager-Event, Distributed Clock, HotConnect
<b>Cube system</b>		
Module capacity	max. 64	
I/O capacity	max. 1024 Byte (Input), max. 1024 Byte (Output)	
<b>Output</b>		
Output voltage (I/Os /Backplane)	24 V DC/5 V DC	
Output current (I/Os /Backplane)	10 A/3 A	
<b>Diagnostic</b>		
Communication status	via LED	
Diagnostic via LED	per module and channel	
Diagnostic via BUS	per module	
Monitoring - under voltage	no	
Monitoring - no voltage	yes	
Short circuit and overload	yes	
Actuator warning	no	
<b>General data</b>		
Protection	IP20	
Connection	Spring clamp plug-in terminals: max. 1.5 mm <sup>2</sup> (max. 10 A)	
Mounting method	DIN-rail mountable (EN 60715)	
Temperature range	0...+60 °C (storage temperature -25...+70 °C)	
<b>Dimension drawing</b>		

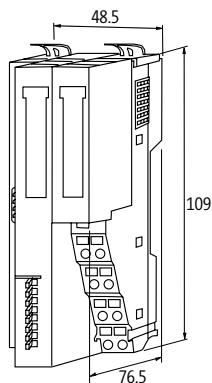

## Notes

# CUBE20S

## Bus Nodes

– Power module included

**CANopen** 

Approvals: 

## Cube20S



## Cube20S



Order Data	Art-No.	Art-No.
CANopen	57104	
Modbus TCP		57108
<b>Connections</b>		
Fieldbus	CAN 1 Mbit/s; SUB-D9	Ethernet 10/100 Mbit/s; 1 × RJ45 (female)
Internal system connection	4 × Spring clamp plug-in terminals, max. 1.5 mm <sup>2</sup> (max. 10 A)	
Sensor-system/actuator supply	4 × Spring clamp plug-in terminals, max. 1.5 mm <sup>2</sup> (max. 10 A)	
<b>Module supply</b>		
Operating voltage	24 V DC (EN 61131-2)	
Current consumption	max. 95 mA	
<b>CANopen</b>		
Addressing	DIP switch	–
<b>Modbus</b>		
Addressing	–	Webserver
<b>Cube system</b>		
Module capacity	max. 64	
I/O capacity	max. 128 Byte (Input), max. 128 Byte (Output)	max. 1024 Byte (Input), max. 1024 Byte (Output)
<b>Output</b>		
Output voltage (I/Os / Backplane)	24 V DC/5 V DC	
Output current (I/Os / Backplane)	10 A/3 A	
<b>Diagnostic</b>		
Communication status	via LED	
Diagnostic via LED	per module and channel	
Diagnostic via BUS	per module	
Monitoring - under voltage	no	
Monitoring - no voltage	yes	
Short circuit and overload	yes	
Actuator warning	no	
<b>General data</b>		
Protection	IP20	
Connection	Spring clamp plug-in terminals: max. 1.5 mm <sup>2</sup> (max. 10 A)	
Mounting method	DIN-rail mountable (EN 60715)	
Temperature range	0...+60 °C (storage temperature -25...+70 °C)	
<b>Dimension drawing</b>		

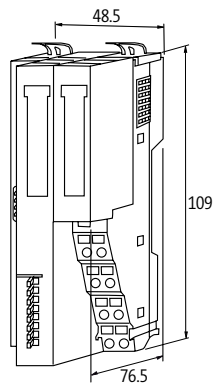

Notes

Cube20S

# CUBE20S

## Power supplies

### Cube20S

Potential distributor



Approvals:  Listed

Cube20S

Order Data	Art-No.	Art-No.	Art-No.
8 × 24 V DC	57120		
8 × 0 V DC		57121	
4×24 + 4×0 V DC			57122
Module supply			
Operating voltage	max. 30 V DC	max. 0 V DC	max. 30 V DC
Total current	max. 10 A		
General data			
Protection	IP20		
Connection	Spring clamp terminals: 0.08...2.5 mm <sup>2</sup> (AWG 28...14)		
Mounting method	DIN-rail mountable (EN 60715)		
Temperature range	0...+60 °C (storage temperature -25...+70 °C)		
Dimension drawing			

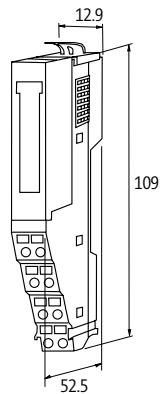

## Notes

# CUBE20S

## Power supplies

### Cube20S

for external voltage supply



### Cube20S

for external voltage supply and internal backplane

Approvals:  **UL** us  
Listed

Order Data	Art-No.	Art-No.
Power module	<b>57130</b>	<b>57131</b>
<b>Module supply</b>		
Operating voltage	max. 28.8 V DC	
Total current	max. 10 A	max. 6 A
<b>Output</b>		
Output current (I/Os /Backplane)	10/0 A	4 A/2 A
Output voltage (I/Os /Backplane)	24 V AC	24 V DC/5 V DC
<b>General data</b>		
Protection	IP20	
Connection	Spring clamp terminals: 0.08...2.5 mm <sup>2</sup> (AWG 28...14)	
Mounting method	DIN-rail mountable (EN 60715)	
Temperature range	0...+60 °C (storage temperature -25...+70 °C)	
<b>Dimension drawing</b>		

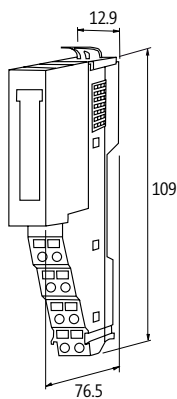

## Notes

# CUBE20S

## Digital inputs

### Cube20S



Approvals:  Listed

Cube20S

Order Data		Art-No.
DI2 - (E) NPN		57220
DI4 - (E)		57240
DI8 - (E)		57280
Internal communication		
Module supply	via system connection	
Current consumption	max. 55 mA	
Input		
Sensor supply US	24 V DC (EN 61131-2), max. 500 mA per module	
Type	PNP (EN 61131-2)	
Input filter	3 ms	
Galvanic isolation	500 V DC between inputs and internal communication	
Diagnostic		
Communication status	via LED	
Diagnostic via LED	per module and channel	
Diagnostic via BUS	per module	
Monitoring - under voltage	no	
Monitoring - no voltage	yes	
Short circuit and overload	yes	
General data		
Protection	IP20	
Connection	Spring clamp plug-in terminals: max. 1.5 mm <sup>2</sup> (AWG 16)	
Mounting method	DIN-rail mountable (EN 60715)	
Temperature range	0...+60 °C (storage temperature -20...+70 °C)	
Dimension drawing		

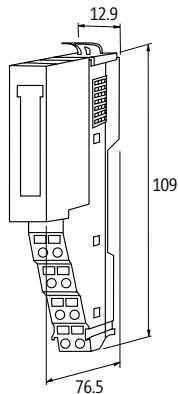

## Notes

# CUBE20S

## Safe inputs (Safety)

– active safety



Approvals: UL<sub>us</sub>  
Listed

## Cube20S FDI4/2



Order Data	Art-No.
FDI4/2 - (E)	57290
Internal communication	
Module supply	via system connection
Current consumption	max. 95 mA
Safety Indicators	
PL	up to e
Category	up to 4
PFH	0.25E-9
DC	high
SIL	up to 3
SIL CL	up to 3
Service life	20 years
Input	
Sensor supply US	24 V DC (EN 61131-2), max. 500 mA per module
Type	PNP (EN 61131-2)
Input filter	3 ms
Galvanic isolation	500 V DC between inputs and internal communication
Diagnostic	
Communication status	via LED
Diagnostic via LED	per module and channel
Diagnostic via BUS	per module and channel
Short circuit and overload	yes
General data	
Protection	IP20
Connection	Spring clamp plug-in terminals: max. 1.5 mm <sup>2</sup> (AWG 16)
Mounting method	DIN-rail mountable (EN 60715)
Temperature range	0...+60 °C (storage temperature -20...+70 °C)
Dimension drawing	

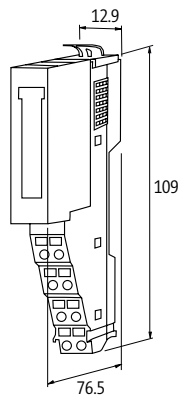

Notes

# CUBE20S

## Digital outputs

### Cube20S



Approvals:  Listed

Cube20S

Order Data	Art-No.
DO2 - (E)	57320
DO4 - (E)	57340
DO8 - (E)	57380

#### Internal communication

Module supply	via system connection
Current consumption	max. 55 mA

#### Output

Actuator supply UA	24 V DC (EN 61131-2), max. 1 A
Switching current per output	max. 0.5 A (short-circuit and overload protected)
Galvanic isolation	500 V DC between outputs and internal communication
Lamp load	5 W
Output delay time	175 ns

#### Diagnostic

Communication status	via LED
Diagnostic via LED	per module and channel
Diagnostic via BUS	per module
Monitoring - under voltage	yes
Monitoring - no voltage	no
Short circuit and overload	yes

#### General data

Protection	IP20
Connection	Spring clamp plug-in terminals: max. 1.5 mm <sup>2</sup> (AWG 16)
Mounting method	DIN-rail mountable (EN 60715)
Temperature range	0...+60 °C (storage temperature -25...+70 °C)

#### Dimension drawing

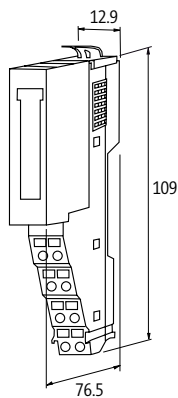

#### Notes



# CUBE20S

## Digital outputs

### Cube20S - 2 A

### Cube20S - 230 V AC (Relays)



Approvals:  UL  
Listed

Order Data	Art-No.	Art-No.
DO2 - (E)	57325	57327
DO4 - (E)	57345	
<b>Internal communication</b>		
Module supply	via system connection	
Current consumption	max. 60 mA	max. 130 mA
<b>Output</b>		
Actuator supply UA	24 V DC (EN 61131-2), max. 4 A	max. 30 V DC/230 V AC
Switching current per output	max. 2 A (short-circuit and overload protected)	max. 3 A (short-circuit and overload protected)
Galvanic isolation	500 V DC between outputs and internal communication	
Lamp load	10 W	–
<b>Diagnostic</b>		
Communication status	via LED	
Diagnostic via LED	per module and channel	
Diagnostic via BUS	per module	
Monitoring - under voltage	yes	
Monitoring - no voltage	no	
Short circuit and overload	yes	
<b>General data</b>		
Protection	IP20	
Connection	Spring clamp plug-in terminals: max. 1.5 mm <sup>2</sup> (AWG 16)	
Mounting method	DIN-rail mountable (EN 60715)	
Temperature range	0...+60 °C (storage temperature -25...+70 °C)	
<b>Dimension drawing</b>		

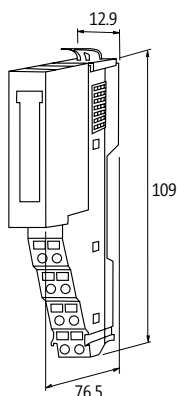

Notes

# CUBE20S

## Safe outputs (Safety)

– active safety



Approvals: UL US Listed

## Cube20S FDO4/2



Cube20S

Order Data		Art-No.
FDO4/2 - (E)		57390
Internal communication		
Module supply	via system connection	
Current consumption	max. 75 mA	
Safety Indicators		
PL	up to e	
Category	up to 4	
PFH	0.22E-9	
DC	high	
SIL	up to 3	
SIL CL	up to 3	
Service life	20 years	
Output		
Actuator supply UA	24 V DC (EN 61131-2), max. 2 A	
Switching current per output	max. 0.5 A (short-circuit and overload protected)	
Galvanic isolation	500 V DC between outputs and internal communication	
Lamp load	5 W	
Output delay time	175 µs	
Diagnostic		
Communication status	via LED	
Diagnostic via LED	per module and channel	
Diagnostic via BUS	per module and channel	
Short circuit and overload	yes	
General data		
Protection	IP20	
Connection	Spring clamp plug-in terminals: max. 1.5 mm <sup>2</sup> (AWG 16)	
Mounting method	DIN-rail mountable (EN 60715)	
Temperature range	0...+60 °C (storage temperature -25...+70 °C)	
Dimension drawing		

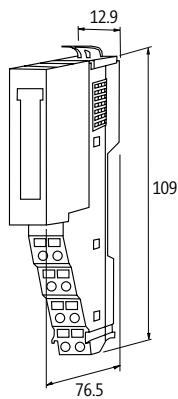

## Notes

## Analog inputs

### Cube20S

Voltage



### Cube20S

Current

### Cube20S

Voltage



Order Data	Art-No.	Art-No.	Art-No.
AI2 - (E)	57231	57232	57233
AI4 - (E)	57261	57262	57263

Internal communication			
Module supply	via system connection		
Current consumption	max. 60 mA from system, max. 25 mA externally (UI)	max. 60 mA from system, max. 15 mA externally (UI)	max. 60 mA from system, max. 25 mA externally (UI)
Input			
Conversion time (analog)	240 µs (all channels)		
Resolution (analog)	15 Bit + sign		
Accuracy	max. ±0.2%	max. 0.3%	max. ±0.2%
Connection	Differential voltage input	Differential current input	Differential voltage input
Voltage inputs			
Input resistor	200 kOhm	–	200 kOhm
Input range	0...10 V	–	-10 V DC...+10 V DC
Current input signals			
Load	–	max. 60 Ohm, (EN 61131-2)	–
Input range	–	0...20 mA, 4...20 mA	–
Diagnostic			
Communication status	via LED		
Diagnostic via LED	per module and channel		
Diagnostic via BUS	per module		
Monitoring - under voltage	yes		
Monitoring - no voltage	no		
Short circuit and overload	yes		
Wire break upper/lower limit overload	per module via LED and BUS		
General data			
Protection	IP20		
Connection	Spring clamp plug-in terminals: max. 1.5 mm <sup>2</sup> (AWG 16)		
Mounting method	DIN-rail mountable (EN 60715)		
Temperature range	0...+60 °C (storage temperature -25...+70 °C)		

## Dimension drawing

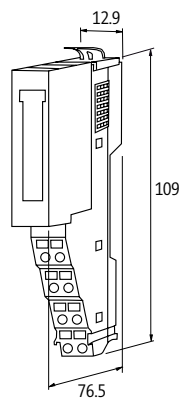

## Notes

Cube20S

# CUBE20S

## Analog inputs

### Cube20S (TH)

for thermo elements

### Cube20S (RTD)

for resistors and temperature



Approvals:  Listed

Cube20S

Order Data	Art-No.	Art-No.
AI2 - (E)	57230	
AI4 - (E)		57265
Internal communication		
Module supply	via system connection	
Current consumption	max. 75 mA from the system, max. 30 mA externally (UI)	max. 75 mA
Input		
Conversion time (analog)	max. 4.2...324.1 ms, 50 Hz (per channel)	
Type	B, C, E, J, K, L, N, R, S, T	Pt100, Pt1000, Ni100, Ni1000, R 0...3000 Ohm
Resolution (analog)	15 Bit + sign	
Accuracy	max. ±0.3%, cold junction compensation	0.7...1.4%
Connection	2-wire input; TH+x, TH-x	2-wire (4 input); 3-, 4-wire (2 input)
Diagnostic		
Communication status	via LED	
Diagnostic via LED	per module and channel	
Diagnostic via BUS	per module	
Monitoring - under voltage	yes	
Monitoring - no voltage	no	
Short circuit and overload	yes	
Wire break upper/lower limit overload	per channel via LED and BUS	
General data		
Protection	IP20	
Connection	Spring clamp plug-in terminals: max. 1.5 mm <sup>2</sup> (AWG 16)	
Mounting method	DIN-rail mountable (EN 60715)	
Temperature range	0...+55 °C (storage temperature -20...+85 °C)	0...+60 °C (storage temperature -25...+70 °C)
Dimension drawing		

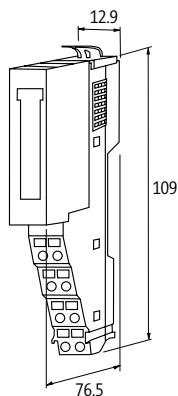

## Notes

# CUBE20S

## Analog outputs

### Cube20S

Voltage







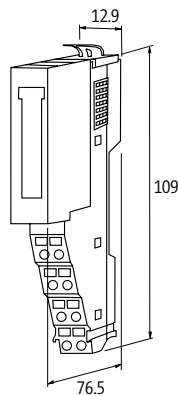

Approvals:  UL Listed

Order Data	Art-No.	Art-No.	Art-No.	Art-No.
AO2 - (E)	57331		57333	
AO4 - (E)		57361		57363
<b>Internal communication</b>				
Module supply	via system connection			
Current consumption	max. 60 mA from system, max. 25 mA externally (UI), idle load			
<b>Output</b>				
Conversion time (analog)	200 µs (all channels)			
Resolution (analog)	15 Bit + sign			
Accuracy	max. 0.5%		max. 0.2%	
Galvanic isolation	500 V DC between inputs and internal communication			
<b>Voltage output signals</b>				
Load	5 kOhm			
Input range	0...10 V		-10 V DC...+10 V DC	
<b>Diagnostic</b>				
Communication status	via LED			
Diagnostic via LED	per module and channel			
Diagnostic via BUS	per module			
Monitoring - under voltage	yes			
Monitoring - no voltage	no			
Short circuit and overload	yes			
Actuator warning	per module via LED and BUS			
Wire break upper/lower limit overload	per module via LED and BUS			
<b>General data</b>				
Protection	IP20			
Connection	Spring clamp plug-in terminals: max. 1.5 mm <sup>2</sup> (AWG 16)			
Mounting method	DIN-rail mountable (EN 60715)			
Temperature range	0...+60 °C (storage temperature -25...+70 °C)			
<b>Dimension drawing</b>				



Notes

# CUBE20S

Connection accessories			Art-No.
	<b>Bus cover</b> Black plastic		57190
	<b>Shield bus carrier</b> Black plastic	Quantity: 10 pcs.	57191
	<b>Bus connection plug 90°</b> SUB-D9 (male), screw terminals	PROFIBUS	55762
	SUB-D9 (female), screw terminals	CANopen	55760
	<b>Bus connection plug 180°</b> SUB-D9 (male), IDC terminals, rigid cable	PROFIBUS	55584
	SUB-D9 (male), IDC terminals, flexible cable	PROFIBUS	55583
	<b>Bus connection plug 90°</b> SUB-D9 (male), IDC terminals, rigid cable	PROFIBUS	55585
	SUB-D9 (male), IDC terminals, flexible cable	PROFIBUS	55587
	<b>Bus connection plug 90°</b> SUB-D9 (male), IDC terminals, rigid cable, programming device conn.	PROFIBUS	55586
	SUB-D9 (male), IDC terminals, flexible cable, programming device conn.	PROFIBUS	55588
	<b>Bus connection plug 90°</b> SUB-D9 (male); M12 × 1, B-coded	PROFIBUS	7000-99441-000000



# MVK METAL COMPACT I/O MODULES FOR DEMANDING REQUIREMENTS

- Tough and reliable
- Safe (safety circuits according to EN 13849-1 up to PL<sub>e</sub>)
- PROFINET – versions compliant with AIDA

## MAXIMUM FLEXIBILITY

MVK Metal features a robust metal housing and is extremely resistant to vibration, media, and weld splatter.

- Double valves occupy only one M12 port
- PROFINET versions with Fast Start Up (< 500 ms)
- Models with multi-functional I/Os
- Fewer variations required, minimizes inventory costs
- Maximum flexibility for expansions

## DON'T LOOK FOR ERRORS, FIND THEM

MVK Metal's diagnostic options offer detailed information about the type and location of the failure or the error.

- Only the affected port shuts down, not the whole module
- Detailed message sent to controls and device LED
- Minimizes downtime – failures are fixed faster

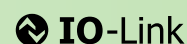

## MVK Metal I/O Modules

 <p><b>MVK-MP</b></p> <ul style="list-style-type: none"> <li>• Multifunctional I/Os</li> <li>• Digital I/Os</li> <li>• Safety outputs</li> <li>• Analog I/Os</li> </ul>  <p>Page 4.4.1</p>	 <p><b>MVK-MPNIO</b></p> <ul style="list-style-type: none"> <li>• Multifunctional I/Os</li> <li>• Digital I/Os</li> <li>• Push Pull</li> <li>• IO-Link</li> <li>• Safety inputs/outputs</li> </ul>    <p>Page 4.4.6</p>
 <p><b>MVK-ME</b></p> <ul style="list-style-type: none"> <li>• Multifunctional I/Os</li> <li>• IO-Link</li> </ul>   <p>Page 4.4.14</p>	 <p><b>MIRO BT</b></p> <ul style="list-style-type: none"> <li>• Bluetooth Master/Slave</li> </ul>  <p>Page 4.4.16</p>

**MVK METAL**

Expanded diagnostic

- 7/8"



Approvals: UL  
Listed

MVK-MP



Order Data	Art-No.	Art-No.	Art-No.
D18 (D18)	55307		
DIO8 (D18)		55308	
DIO8 (DIO8)			55309
<b>Connections</b>			
Fieldbus	PROFIBUS 12 Mbit/s; M12, B-coded		
Sensor-system/actuator supply	7/8", 5-pole, 2 x max. 9 A		
I/O ports	M12, 5-pole, A-coded		
<b>PROFIBUS</b>			
Addressing	Rotary switch 1...99		
<b>Input</b>			
Sensor supply US	24 V DC (EN 61131-2), max. 200 mA (M12 female), short-circuit and overload protected		
Type	for 3-wire sensors or mechanical switches, PNP		
<b>Output</b>			
Actuator supply UA	-	24 V DC (EN 61131-2), max. 9 A	
Switching current per output	-	max. 1.6 A (short-circuit and overload protected)	
Lamp load	-	10 W	
<b>Parameterization</b>			
PIN 4	Input	Input/Output	
PIN 2	Input/Diagnostic	Input/Output/Diagnostic	
<b>General data</b>			
Protection	IP67		
Mounting method	2-hole screw mounting		
Temperature range	-25...+55 °C (storage temperature -25...+70 °C)		
<b>Dimension drawing</b>			

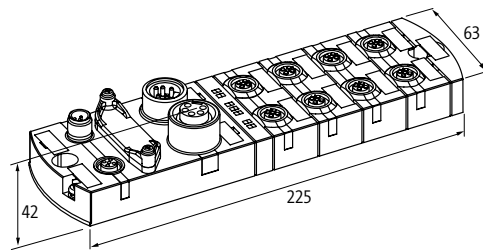

Notes



# MVK METAL

Expanded diagnostic

- 7/8"



MVK-MP



Order Data	Art-No.	Art-No.
DO8 (DO8)	55290	
DO4 (DO4) DI4 (DI4)		55274
Connections		
Fieldbus	PROFIBUS 12 Mbit/s; M12, B-coded	
Sensor-system/actuator supply	7/8", 5-pole, 2 × max. 9 A	
I/O ports	M12, 5-pole, A-coded	
PROFIBUS		
Addressing	Rotary switch 1...99	
Input		
Sensor supply US	-	24 V DC (EN 61131-2), max. 200 mA (M12 female), short-circuit and overload protected
Type	-	for 3-wire sensors or mechanical switches, PNP
Output		
Actuator supply UA	24 V DC (EN 61131-2), max. 9 A	
Switching current per output	max. 1.6 A (short-circuit and overload protected)	
Lamp load	10 W	
General data		
Protection	IP67	
Mounting method	2-hole screw mounting	
Temperature range	-25...+55 °C (storage temperature -25...+70 °C)	
Dimension drawing		

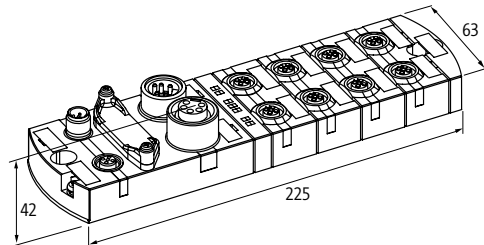

Notes

## MVK METAL

### Expanded diagnostic

- passive safety
- Output groups up to PLd (EN ISO 13849-1) can be switched off via safety relays

PROFIBUS

Approvals:  UL US  
Listed

### MVK-MP Safety



Order Data	Art-No.
K3 DO4 (DO4) DIO4 (DIO4)	55291
Connections	
Fieldbus	PROFIBUS 12 Mbit/s; M12, B-coded
I/O ports	M12, 5-pole, A-coded
Sensor-system/actuator supply	7/8", 5-pole, max. 9 A, safe circuits (1 + 2) via separate 7/8" supply (yellow), 2-pole disconnectable
PROFIBUS	
Addressing	Rotary switch 1...99
Input	
Sensor supply US	24 V DC (EN 61131-2), max. 200 mA (M12 female), short-circuit and overload protected
Type	for 3-wire sensors or mechanical switches, PNP
Output	
Actuator supply UA	24 V DC (EN 61131-2), 3 circuits, (max. 9 A)
Switching current per output	max. 1.6 A (short-circuit and overload protected)
Lamp load	10 W
Safe output	
Switching current by safe output	max. 2 A short-circuit and overload protected, (EN13849-1) PLd
M12-(yellow) PIN 4	2 safety circuits (UA1/UA2) with 2 digital outputs each (EN13849-1) PLd
M12-(yellow) PIN 2	2 safety circuits (UA1/UA2) with 2 digital outputs each (EN13849-1) PLd
Parameterization	
PIN 4	4 × input/output
PIN 2	4 × Input/Output/Diagnostic
General data	
Protection	IP67
Mounting method	2-hole screw mounting
Temperature range	0...+55 °C (storage temperature -20...+70 °C)
Dimension drawing	

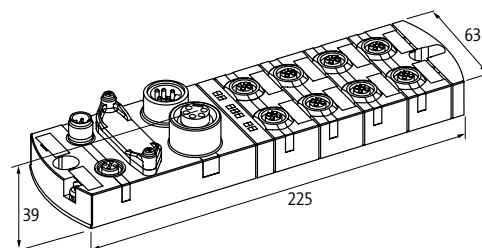

Notes

# MVK METAL

## Expanded diagnostic

– Analog outputs

– Current



Approvals: Listed

## MVK-MP



Order Data	Art-No.
AO4 (I) DIO4 (DIO4)	55292
Connections	
Fieldbus	PROFIBUS 12 Mbit/s; M12, B-coded
Sensor-system/actuator supply	7/8", 5-pole, 2 × max. 9 A
I/O ports	M12, 5-pole, A-coded
PROFIBUS	
Addressing	Rotary switch 1...99
Input	
Sensor supply US	24 V DC (EN 61131-2), max. 200 mA (M12 female), short-circuit and overload protected
Type	for 3-wire sensors or mechanical switches, PNP
Output	
Actuator supply UA	24 V DC (EN 61131-2), max. 9 A
Switching current per output	max. 1.6 A (short-circuit and overload protected)
Lamp load	10 W
Input range (analog)	0...20 mA, 4...20 mA (0...10 V via adapter Art.-No. 7000-42252-0000000)
Conversion time (analog)	1 ms
General data	
Protection	IP67
Mounting method	2-hole screw mounting
Temperature range	0...+55 °C (storage temperature -20...+70 °C)
Dimension drawing	

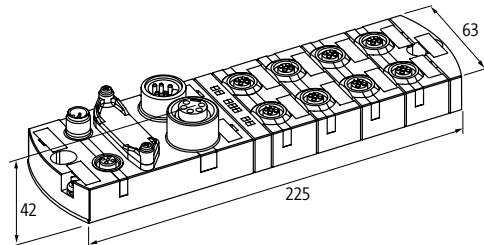

## Notes

## MVK METAL

### Expanded diagnostic

– Analog inputs

– Voltage



Approvals: UL Listed

### MVK-MP



Order Data	Art-No.
AI4 (U) DIO4 (DIO4)	55293
Connections	
Fieldbus	PROFIBUS 12 Mbit/s; M12, B-coded
Sensor-system/actuator supply	7/8", 5-pole, 2 × max. 9 A
I/O ports	M12, 5-pole, A-coded
PROFIBUS	
Addressing	Rotary switch 1...99
Input	
Sensor supply US	24 V DC (EN 61131-2), max. 200 mA (M12 female), short-circuit and overload protected
Type	for 3-wire sensors or mechanical switches, PNP
Resolution (analog)	16 Bit
Input range (analog)	0...10 V, (0...20 mA and 4...20 mA via adapter Art.-No. 7000-42251-0000000)
Input resistor (analog)	approx. 1 MOhm, differential input
Conversion time (analog)	1 ms
Output	
Actuator supply UA	24 V DC (EN 61131-2), max. 9 A
Lamp load (8×M12 left)	max. 1.6 A (short-circuit and overload protected)
Lamp load	10 W
General data	
Protection	IP67
Mounting method	2-hole screw mounting
Temperature range	0...+55 °C (storage temperature -20...+70 °C)
Dimension drawing	

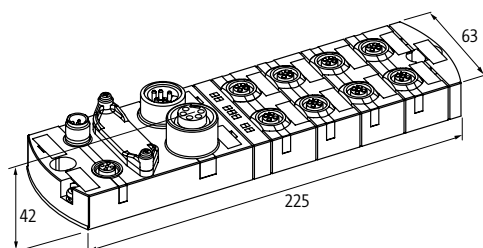

### Notes

# MVK METAL

Galvanic isolation K3

– POF Push Pull



Approvals: Listed

MVK+ MPNIO POF



Order Data	Art-No.	Art-No.
D18 D18 IRT	55254	
D18 DO8 IRT		55255
<b>Connections</b>		
Fieldbus	Ethernet 10/100 Mbit/s; 2 × SCRJ45 POF-Push Pull	
Sensor-system/actuator supply	Power plug, Push Pull, max. 12 A	
I/O ports	M12, 5-pole, A-coded	
<b>PROFINET</b>		
FSU (Fast-Start-Up)	max. 500 ms	
Shared Device/Input	yes, for 2 controls	
Profinet Netload Class	III	
Specification	V2.2, Conformance Class C (IRT)	
MRP	yes	
Addressing	DCP	
<b>Input</b>		
Sensor supply US	24 V DC (EN 61131-2), max. 200 mA (M12 female), short-circuit and overload protected	
Type	for 3-wire sensors or mechanical switches, PNP	
<b>Output</b>		
Actuator supply UA	–	24 V DC (EN 61131-2), max. 12 A
Switching current per output	–	max. 2 A (short-circuit and overload protected)
Lamp load	–	10 W
<b>Parameterization</b>		
PIN 4	Input	Input (port 4...7); Output (port 0...3)
PIN 2	Input	Input (port 4...7); Output (port 0...3)
<b>General data</b>		
Protection	IP67	
Mounting method	2-hole screw mounting	
Temperature range	0...+55 °C (storage temperature -20...+70 °C)	
<b>Dimension drawing</b>		

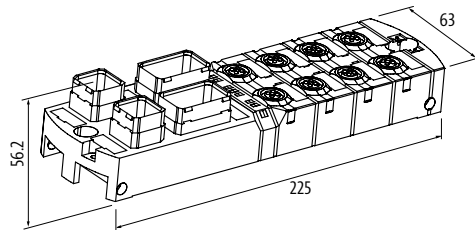

Notes

MVK Metal

## MVK METAL

### Galvanic isolation K3

#### – Push Pull



### MVK+ MPNIO



Order Data	Art-No.	Art-No.
DI8 DI8 IRT	55528	
DI8 DO8 IRT		55529
<b>Connections</b>		
Fieldbus	Ethernet 10/100 Mbit/s; Push Pull RJ45 Data connector	
Sensor-system/actuator supply	Power plug, Push Pull, max. 12 A	
I/O ports	M12, 5-pole, A-coded	
<b>PROFINET</b>		
FSU (Fast-Start-Up)	max. 500 ms	
Shared Device/Input	yes, for 2 controls	
Profinet Netload Class	III	
Specification	V2.2, Conformance Class C (IRT)	
MRP	yes	
Addressing	DCP	
<b>Input</b>		
Sensor supply US	24 V DC (EN 61131-2), max. 200 mA (M12 female), short-circuit and overload protected	
Type	for 3-wire sensors or mechanical switches, PNP	
<b>Output</b>		
Actuator supply UA	–	24 V DC (EN 61131-2), max. 12 A
Switching current per output	–	max. 2 A (short-circuit and overload protected)
Lamp load	–	10 W
<b>Parameterization</b>		
PIN 4	Input	Input (port 4...7); Output (port 0...3)
PIN 2	Input	Input (port 4...7); Output (port 0...3)
<b>General data</b>		
Protection	IP67	
Mounting method	2-hole screw mounting	
Temperature range	0...+55 °C (storage temperature -20...+70 °C)	
<b>Dimension drawing</b>		

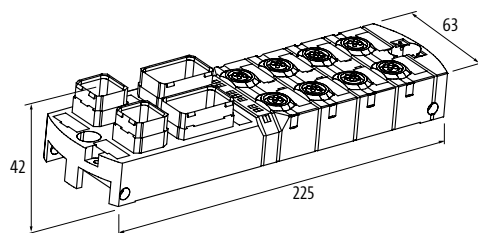

Notes

# MVK METAL

## Galvanic isolation K3

### – Push Pull



## MVK+ MPNIO



Order Data	Art-No.
DIO8 (DIO8)	55283
Connections	
Fieldbus	Ethernet 10/100 Mbit/s; Push Pull RJ45 Data connector
Sensor-system/actuator supply	Power plug, Push Pull, max. 12 A
I/O ports	M12, 5-pole, A-coded
PROFINET	
Specification	V2.2, Conformance Class B
MRP	yes
Addressing	DCP
Input	
Sensor supply US	24 V DC (EN 61131-2), max. 200 mA (M12 female), short-circuit and overload protected
Type	for 3-wire sensors or mechanical switches, PNP
Output	
Actuator supply UA	24 V DC (EN 61131-2), max. 12 A
Switching current per output	max. 1.6 A (short-circuit and overload protected)
Lamp load	10 W
Parameterization	
PIN 4	Input/Output
PIN 2	Input/Output/Diagnostic
General data	
Protection	IP67
Mounting method	2-hole screw mounting
Temperature range	0...+55 °C (storage temperature -20...+70 °C)
Dimension drawing	

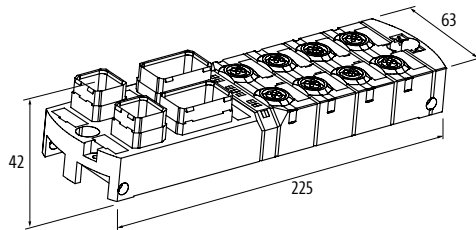

## Notes

## MVK METAL

Galvanic isolation K3

– FSU (Fast-Start-Up)

– 7/8"



Approvals: UL<sub>us</sub>  
Listed

MVK+ MPNIO



Order Data	Art-No.
DO8 (DI4 DI4)	55339
Connections	
Fieldbus	Ethernet 10/100 Mbit/s; M12, D-coded
Sensor-system/actuator supply	7/8", 5-pole, max. 9 A, protection against reverse polarization
I/O ports	M12, 5-pole, A-coded
PROFINET	
FSU (Fast-Start-Up)	max. 500 ms
Specification	V2.2, Conformance Class B
MRP	yes
Addressing	DCP
Input	
Sensor supply US	24 V DC (EN 61131-2), max. 200 mA (M12 female), short-circuit and overload protected
Type	for 3-wire sensors or mechanical switches, PNP
Output	
Actuator supply UA	24 V DC (EN 61131-2), max. 9 A
Switching current per output	max. 2 A (short-circuit and overload protected)
Lamp load	10 W
Parameterization	
PIN 4	Input (port 4...7); Output (port 0...3)
PIN 2	Input (port 4...7); Output (port 0...3)
General data	
Protection	IP67
Mounting method	2-hole screw mounting
Temperature range	-25...+55 °C (storage temperature -25...+70 °C)
Dimension drawing	

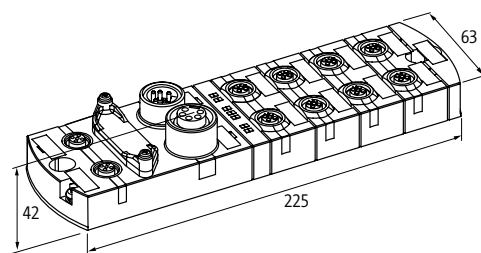

Notes



# MVK METAL

## FSU (Fast-Start-Up)

- 7/8"



## MVK-MPNIO



Order Data		Art-No.
DIO16 IRT		55530
Connections		
Fieldbus	Ethernet 10/100 Mbit/s; M12, D-coded	
Sensor-system/actuator supply	7/8", 5-pole, 2 × max. 9 A	
I/O ports	M12, 5-pole, A-coded	
PROFINET		
FSU (Fast-Start-Up)	max. 500 ms	
Shared Device/Input	yes, for 2 controls	
Profinet Netload Class	III	
Specification	V2.3, Conformance Class C (IRT)	
MRP	yes	
Addressing	DCP	
Input		
Sensor supply US	24 V DC (EN 61131-2), max. 200 mA (M12 female), short-circuit and overload protected	
Type	for 3-wire sensors or mechanical switches, PNP	
Output		
Actuator supply UA	24 V DC (EN 61131-2), max. 9 A	
Switching current per output	max. 1.6 A (short-circuit and overload protected)	
Lamp load	10 W	
Parameterization		
PIN 4	Input/Output (port X0...X7)	
PIN 2	Input/Output (port X0...X7)	
General data		
Protection	IP67	
Mounting method	2-hole screw mounting	
Temperature range	-25...+60 °C (storage temperature -25...+70 °C)	
Dimension drawing		

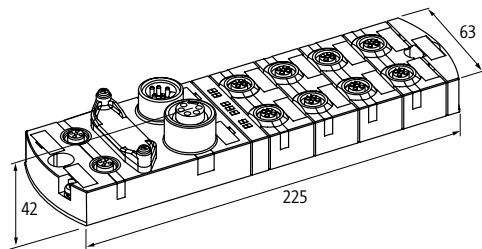

## Notes

**MVK METAL**

**FSU (Fast-Start-Up)**

- 7/8"

**PROFINET** **IO-Link**

**MVK-MPNIO IO-Link**



**MVK-MPNIO IO-Link**



Order Data	Art-No.	Art-No.
DIO14 IOL2 IRT	55531	
DIO12 IOL4 IRT		55532
<b>Connections</b>		
Fieldbus	Ethernet 10/100 Mbit/s; M12, D-coded	
Sensor-system/actuator supply	7/8", 5-pole, 2 x max. 9 A	
I/O ports	M12, 5-pole, A-coded	
<b>PROFINET</b>		
FSU (Fast-Start-Up)	max. 500 ms	
Shared Device/Input	yes, for 2 controls	
Profinet Netload Class	III	
Specification	V2.3, Conformance Class C (IRT)	
MRP	yes	
Addressing	DCP	
<b>IO-Link</b>		
IO-Link	2 x Master	4 x Master
Operating modes	COM1; COM2; COM3 (automatic)	
Transfer parameters	32 Byte (via IO-Link Port)	
Port class	Class B (not galvanically separated)	Class A + B (not galvanically separated)
Specification	IO-Link Master V1.12	
<b>Input</b>		
Sensor supply US	24 V DC (EN 61131-2), max. 200 mA (M12 female), short-circuit and overload protected	
Type	for 3-wire sensors or mechanical switches, PNP, IO-Link Devices	
<b>Output</b>		
Actuator supply UA	24 V DC (EN 61131-2), max. 9 A	
Switching current per output	max. 1.6 A (short-circuit and overload protected)	
Lamp load	10 W	
<b>Parameterization</b>		
PIN 4	Input (port X0...X7); Output (port X0...X5); IO-Link Master (port X6, X7)	Input (port X0...X7); Output (port X0...X3); IO-Link Master (port X4...X7)
PIN 2	Input/Output (port X0...X7); U-Actuator IO-Link Class B (port X6, X7)	
<b>General data</b>		
Protection	IP67	
Mounting method	2-hole screw mounting	
Temperature range	-25...+60 °C (storage temperature -25...+70 °C)	
<b>Dimension drawing</b>		

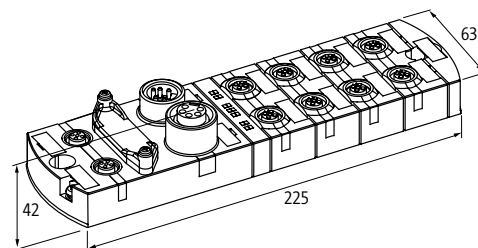

Notes

MVK Metal

# MVK METAL

## Active safety

- safe inputs/outputs up to cat.4/PLe (EN ISO 13849-1), up to SIL3 (IEC 61508), up to SILCL3 (IEC 62061)



Approvals: Listed

## MVK-MPNIO Safety

Push Pull



Order Data	Art-No.	Art-No.
DI16/8 F	55562	
DI8/4 F DO4		55563
<b>Safety Indicators</b>		
PL	up to e	
Category	up to 4	
PFH	1.70E-9	1.653E-9
DC	98%	
SIL	up to 3	
SIL CL	up to 3	
Service life	20 years	
<b>Connections</b>		
Fieldbus	Ethernet 10/100 Mbit/s; Push Pull RJ45 Data connector	
Sensor-system/actuator supply	Power plug, Push Pull, max. 12 A	
I/O ports	M12, 5-pole, A-coded	
<b>PROFINET</b>		
Shared Device/Input	yes, for 2 controls	
Specification	V2.2, Conformance Class C (IRT)	
MRP	yes	
Addressing	DCP	
<b>Safety input</b>		
Sensor supply US	24 V DC (EN 61131-2), max. 200 mA (PIN 1+5), short-circuit and overload protected, or max. 700 mA for only one PIN	
Type	for electrical sensors or mechanical switches	
<b>Safe output</b>		
Actuator supply UA	–	24 V DC (EN 61131-2), max. 9 A
Switching current by safe output	–	max. 2 A (short-circuit and overload protected)
<b>General data</b>		
Protection	IP67	
Mounting method	2-hole screw mounting	
Temperature range	-20...+55 °C (storage temperature -40...+70 °C)	
<b>Dimension drawing</b>		

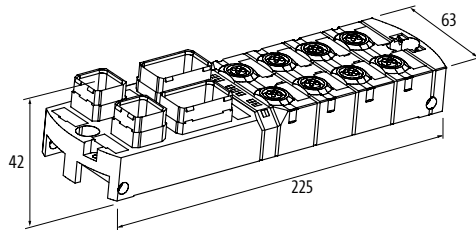

## Notes

## MVK METAL

### Active safety

- safe inputs/outputs up to cat.4/PLe (EN ISO 13849-1), up to SIL3 (IEC 61508), up to SILCL3 (IEC 62061)



Approvals: UL<sub>us</sub> Listed

### MVK-MPNIO Safety

7/8"



Order Data	Art-No.	Art-No.
DI16/8 F IRT	55556	
DI8/4 F DO4 IRT		55557
<b>Safety Indicators</b>		
PL	up to e	
Category	up to 4	
PFH	1.70E-9	1.653E-9
DC	98%	
SIL	up to 3	
SIL CL	up to 3	
Service life	20 years	
<b>Connections</b>		
Fieldbus	Ethernet 10/100 Mbit/s; M12, D-coded	
Sensor-system/actuator supply	7/8", 5-pole, 2 × max. 9 A	
I/O ports	M12, 5-pole, A-coded	
<b>PROFINET</b>		
Shared Device/Input	yes, for 2 controls	
Specification	V2.2, Conformance Class C (IRT)	
MRP	yes	
Addressing	DCP	
<b>Safety input</b>		
Sensor supply US	24 V DC (EN 61131-2), max. 200 mA (PIN 1+5), short-circuit and overload protected, or max. 700 mA for only one PIN	
Type	for electronic sensors or mechanical switches	
<b>Safe output</b>		
Actuator supply UA	–	24 V DC (EN 61131-2), max. 9 A
Switching current by safe output	–	max. 2 A (short-circuit and overload protected)
<b>General data</b>		
Protection	IP67	
Mounting method	2-hole screw mounting	
Temperature range	-20...+55 °C (storage temperature -40...+70 °C)	
<b>Dimension drawing</b>		

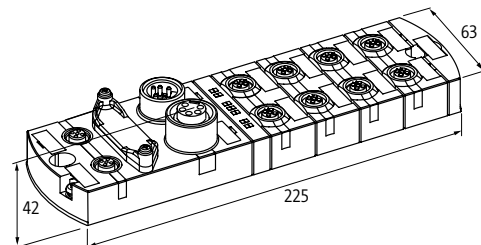

Notes

MVK Metal

# MVK METAL

## Expanded diagnostic

– 7/8"

EtherNet/IP

Approvals:  

### MVK-ME

DIO8 (DIO8)  
DLR (Device Level Ring)

### MVK-ME

DIO16  
DLR (Device Level Ring)



Order Data	Art-No.	Art-No.
DIO8 (DIO8)	55099	
DIO16		55542
Connections		
Fieldbus	Ethernet 10/100 Mbit/s; M12, D-coded	
Sensor-system/actuator supply	7/8", 5-pole, 2 × max. 9 A	7/8", 4-pole, 2 × max. 9 A
I/O ports	M12, 5-pole, A-coded	
EtherNet/IP		
Addressing	DHCP, BOOTP or IP address by rotary switch	DHCP, BOOTP or IP address by DIP switch
DLR (Device Level Ring)	yes	
QC (Quick Connect)	–	max. 360 ms
Multiple connections	–	yes
CIP Sync	–	yes
Composite Test Revision	–	CT14
Input		
Sensor supply US	24 V DC (EN 61131-2), max. 200 mA (M12 female), short-circuit and overload protected	
Type	for 3-wire sensors or mechanical switches, PNP	
Output		
Actuator supply UA	24 V DC (EN 61131-2), max. 9 A	
Switching current per output	max. 1.6 A (short-circuit and overload protected)	
Lamp load	10 W	
Parameterization		
PIN 4	Input/Output (port X0...X7)	
PIN 2	Input/Output (port X0...X7)	
General data		
Protection	IP67	
Mounting method	2 hole screw mounting, compatible with I/O modules of MVK model range	2-hole screw mounting
Temperature range	-25...+55 °C (storage temperature -25...+70 °C)	-25...+60 °C (storage temperature -40...+85 °C)
Dimension drawing		

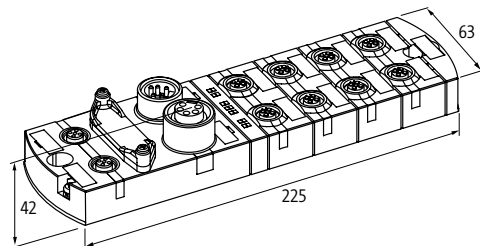

## Notes

# MVK METAL

Expanded diagnostic

- 7/8"

EtherNet/IP IO-Link

Approvals:

## MVK-ME IO-Link

DIO14 IOL2  
DLR (Device Level Ring)

## MVK-ME IO-Link

DIO12 IOL4  
DLR (Device Level Ring)



Order Data	Art-No.	Art-No.
DIO14 IOL2	55543	
DIO12 IOL4		55544
<b>Connections</b>		
Fieldbus	Ethernet 10/100 Mbit/s; M12, D-coded	
Sensor-system/actuator supply	7/8", 4-pole, 2 × max. 9 A	
I/O ports	M12, 5-pole, A-coded	
<b>EtherNet/IP</b>		
Addressing	DHCP, BOOTP or IP address by DIP switch	
QC (Quick Connect)	max. 360 ms	
Multiple connections	yes	
CIP Sync	yes	
Composite Test Revision	CT14	
DLR (Device Level Ring)	yes	
<b>IO-Link</b>		
IO-Link	2 × Master	4 × Master
Operating modes	COM1; COM2; COM3 (automatic)	
Transfer parameters	32 Byte (via IO-Link Port)	
Port class	Class B (not galvanically separated)	
Specification	IO-Link Master V1.12	
<b>Input</b>		
Sensor supply US	24 V DC (EN 61131-2), max. 200 mA (M12 female), short-circuit and overload protected	
Type	for 3-wire sensors or mechanical switches, PNP, IO-Link Devices	
<b>Output</b>		
Actuator supply UA	24 V DC (EN 61131-2), max. 9 A	
Switching current per output	max. 1.6 A (short-circuit and overload protected)	
Lamp load	10 W	
<b>Parameterization</b>		
PIN 4	Input/Output (port X0...X7); IO-Link Master (port X6, X7)	Input/Output (port X0...X7); IO-Link Master (port X4...X7)
PIN 2	Input/Output (port X0...X7); U-Actuator IO-Link Class B (port X6, X7)	Input/Output (port X0...X7); U-Actuator IO-Link Class B (port X4...X7)
<b>General data</b>		
Protection	IP67	
Mounting method	2-hole screw mounting	
Temperature range	-25...+55 °C (storage temperature -40...+85 °C)	
<b>Dimension drawing</b>		

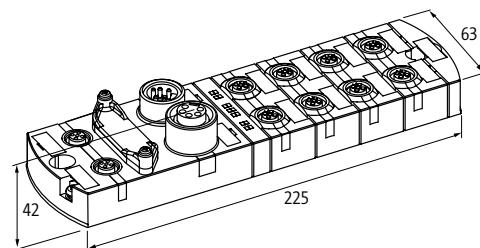

Notes

MVK Metal

# MVK METAL

## Accessories for MVK PROFINET

### – Wireless transmission



### MIRO BT





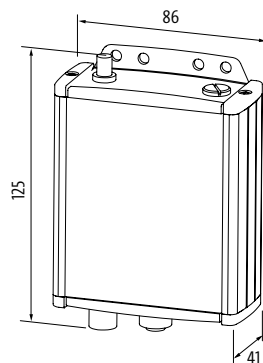

Bluetooth Master/Slave  
PROFINET



<b>Order Data</b>		<b>Art-No.</b>
Master/Slave		<b>57018</b>
<b>Connections</b>		
Fieldbus	Ethernet 10/100Mbit/s; M12, D-coded	
Supply	M12, 5-pole, A-coded	
<b>Technical Data</b>		
Operating voltage	24 V DC (EN 61131-2)	
Operating current	max. 150 mA	
<b>Wireless technology</b>		
Frequency	2.4 GHz Bluetooth	
Transmission power	100 mW	
No. of wireless slaves/devices	max. 4/max. 6	
Coverage indoor	100 m	
Coverage outdoor	300 m	
Antenna connection	SMA (50 Ohm)	
<b>General data</b>		
Standards	approved in: BE, DK, DE, EE, FI, FR (restricted), GR, GB, IE, IS, IT, CA, LV, LT, LU, MT, NL, NO (without Spitzbergen), AT, PL, PT, SE, CH, SK, SI, ES, CZ, HU, US, CY	
Housing	Metal black	
Protection	IP65	
Mounting method	screw fixing, M4	
Temperature range	-20...+60 °C (storage temperature -40...+75 °C)	
<b>Dimension drawing</b>		



### Notes

Blind Plug/caps		Art-No.
	<b>Screw plug M12 x 1 mm</b> Metal, hex, 1 piece	996049
	<b>Blind cap 7/8"</b> Metal	55390
	<b>Blind plug diagnostic M12 x 1 mm</b> Bridge PIN 1 and PIN 2	7000-13481-0000000
	<b>Addressing cap</b> Metal	55317
Labeling accessories		Art-No.
	<b>Label plates</b> 20 x 8 mm	(20 pieces per plate) 55318
Connection accessories		Art-No.
	<b>Adapter</b> Current /voltage converter Voltage/current converter	7000-42251-0000000 7000-42252-0000000
	<b>MVK Push Pull</b> Dust Protection Set	553260
	<b>Ground strap 4 mm²</b> 100 mm for screw (M4)	4000-71001-0410004
	<b>Screw plug M23</b> Metal	55352
	<b>Adapter plug M12/M12 for inputs</b>	7030-42291-0000000



## MVK METAL

Connection accessories			Art-No.
	<p><b>T-coupler (Slim Line)</b> Male straight - female/male straight M12 - M12, 4-pole for 8-pole units</p>	<p>AIDA conform Connection cable L = 200 mm</p>	<p><b>7030-42602-0000000</b></p>
	<p><b>T-coupler (Slim Line)</b> Male straight - female/male straight M12 - M12, 2-pole</p>	<p>AIDA conform Connection cable L = 200 mm</p>	<p><b>7030-42612-0000000</b></p>
	<p><b>T-coupler (SlimLine) M12 - M12</b> 5-pole</p>		<p><b>7000-41155-0000000</b></p>
	<p><b>Cable fixation 8xM12</b> Cable diameter (4...7 mm)</p>		<p><b>55554</b></p>

# SOLID67 COMPACT I/O-MODULES

- Shorter installation times and Using all slots
- Minimizing space requirements
- Simplifying storage

## PROTOCOL CHANGE IN THE BLINK OF AN EYE

SOLID67 are the new compact I/O modules from Murrelektronik. They make installation in the field easier and are very attractive for applications with IO-Link sensors and actuators. They provide eight IO-Link slots directly adjacent to the process and can easily incorporate classic IOs into the system.

Full encapsulation and impressive vibration and shock values (15 and 50 G) prepare the modules for use in harsh industrial environments – within a temperature range of –20 to +70 °C. This opens a door to numerous applications. Comprehensive diagnostic options at the module, through the control unit, and through an integrated web server, make troubleshooting a simple exercise.

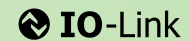

Shorter installation times



Using all slots



Minimizing space requirements



Simplifying storage

## SOLID67 I/O-Modules



**SOLID67 PN/E 60 mm**  
• Multi protocol



Page 4.5.1



**SOLID67 PN/E 60 mm**  
• Multi protocol  
• IOL8



Page 4.5.3



**SOLID67 PN/E 30 mm**  
• Multi protocol  
• IOL8



Page 4.5.4

## Multi protocol



## SOLID67 PN/E

60 mm



Order Data	Art-No.	Art-No.
DI16	54500	
DI8 DO8		54501
<b>Connections</b>		
Fieldbus	Ethernet 10/100 Mbit/s; M12, D-coded	
Sensor-system/actuator supply	M12 Power, 5-pole, L-coded	
I/O ports	M12, 5-pole, A-coded	
<b>PROFINET</b>		
Addressing	DCP	
Shared Device/Input	-	
Profinet Netload Class	III	
Specification	V2.3, Conformance Class C (IRT)	
MRP	yes	
<b>EtherNet/IP</b>		
Addressing	DHCP, BOOTP or IP address by rotary switch	
QC (Quick Connect)	max. 500 ms	
DLR (Device Level Ring)	yes	
<b>Input</b>		
Sensor supply US	24 V DC (EN 61131-2), max. 200 mA (M12 female), short-circuit and overload protected	
Type	for 3-wire sensors or mechanical switches, PNP	
<b>Output</b>		
Actuator supply UA	-	24 V DC (EN 61131-2), max. 9 A
Switching current per output	-	max. 2 A (short-circuit and overload protected)
<b>Parameterization</b>		
PIN 4	Input (port X1...X8)	Input (port X1...X4); Output (port X5...X8)
PIN 2	Input (port X1...X8)	Input (port X1...X4); Output (port X5...X8)
<b>General data</b>		
Protection	IP67	
Mounting method	2-hole screw mounting	
Temperature range	-20...+70 °C	
<b>Dimension drawing</b>		

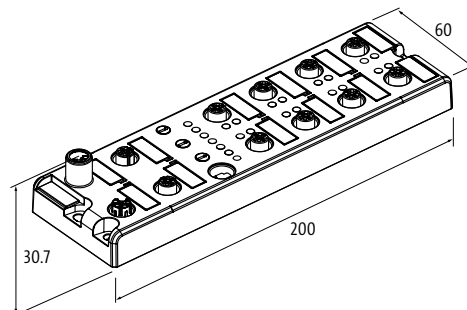

Notes

# SOLID67

Multi protocol



## SOLID67 PN/E

60 mm



Order Data	Art-No.	Art-No.
DIO16	54503	
DO16		54502
<b>Connections</b>		
Fieldbus	Ethernet 10/100 Mbit/s; M12, D-coded	
Sensor-system/actuator supply	M12 Power, 5-pole, L-coded	
I/O ports	M12, 5-pole, A-coded	
<b>PROFINET</b>		
Addressing	DCP	
Shared Device/Input	-	
Profinet Netload Class	III	
Specification	V2.3, Conformance Class C (IRT)	
MRP	yes	
<b>EtherNet/IP</b>		
Addressing	DHCP, BOOTP or IP address by rotary switch	
QC (Quick Connect)	max. 500 ms	
DLR (Device Level Ring)	yes	
<b>Input</b>		
Sensor supply US	24 V DC (EN 61131-2), max. 200 mA (M12 female), short-circuit and overload protected	-
Type	for 3-wire sensors or mechanical switches, PNP	-
<b>Output</b>		
Actuator supply UA	24 V DC (EN 61131-2), max. 9 A	
Switching current per output	max. 2 A (short-circuit and overload protected)	
<b>Parameterization</b>		
PIN 4	Input/Output (port X1...X8)	Output (port X1...X8)
PIN 2	Input/Output (port X1...X8)	Output (port X1...X8)
<b>General data</b>		
Protection	IP67	
Mounting method	2-hole screw mounting	
Temperature range	-20...+70 °C	
<b>Dimension drawing</b>		

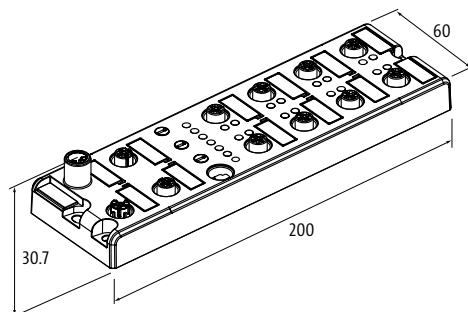

Notes

# SOLID67

Multi protocol

**PROFINET** EtherNet/IP™

**IO-Link**

Approvals:  UL Listed

## SOLID67 PN/E

IOL8  
60 mm



Order Data	Art-No.
IOL8	54504
Connections	
Fieldbus	Ethernet 10/100 Mbit/s; M12, D-coded
Sensor-system/actuator supply	M12 Power, 5-pole, L-coded
I/O ports	M12, 5-pole, A-coded
PROFINET	
Addressing	DCP
Shared Device/Input	yes, for 2 controls
Profinet Netload Class	II
Specification	V2.3, Conformance Class C (IRT)
MRP	yes
EtherNet/IP	
Addressing	DHCP, BOOTP or IP address by rotary switch
DLR (Device Level Ring)	yes
IO-Link	
IO-Link	8 × Master
Operating modes	COM1; COM2; COM3 (automatic)
Transfer parameters	32 Input byte and/or 32 Output byte (per IO-Link port)
Port class	4 × A (port X1...X4), 4 × B (port X5...X8, galvanically separated, max. 2 A per port)
Specification	IO-Link Master V1.1
Input	
Sensor supply US	24 V DC (EN 61131-2), max. 500 mA (M12 female), short-circuit and overload protected
Type	for 3-wire sensors or mechanical switches, PNP, IO-Link Devices
Output	
Actuator supply UA	24 V DC (EN 61131-2), max. 9 A
Switching current per output	max. 0.5 A (PIN 4, X1...X8); 2 A (PIN 2/5 Uaux, X5...X8), short-circuit and overload protected
Parameterization	
PIN 4	Input (port X1...X8); Output (port X1...X8); IO-Link Master (port X1...X8)
PIN 2	Input (port X1...X4); Output (port X5...X8)
General data	
Protection	IP67
Mounting method	2-hole screw mounting
Temperature range	-20...+70 °C
Dimension drawing	

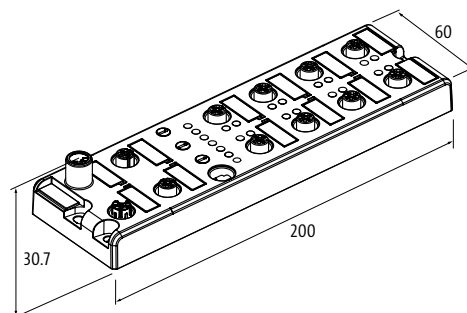

Notes

# SOLID67

Multi protocol

**PROFINET** EtherNet/IP™

**IO-Link**

Approvals:  UL US Listed

## SOLID67 PN/E

IOL8  
30 mm



## SOLID67 PN/E

IOL8  
30 mm



Order Data	Art-No.	Art-No.
IOL8	54505	54506
<b>Connections</b>		
Fieldbus	Ethernet 10/100 Mbit/s; M12, D-coded	
Sensor-system/actuator supply	M12 Power, 5-pole, L-coded	
I/O ports	M12, 5-pole, A-coded	M8, 5-pole, B-coded
<b>PROFINET</b>		
Addressing	DCP	
Shared Device/Input	yes, for 2 controls	
Profinet Netload Class	II	
Specification	V2.3, Conformance Class C (IRT)	
MRP	yes	
<b>EtherNet/IP</b>		
Addressing	DHCP, BOOTP or IP address by rotary switch	
DLR (Device Level Ring)	yes	
<b>IO-Link</b>		
IO-Link	8 × Master	
Operating modes	COM1; COM2; COM3 (automatic)	
Transfer parameters	32 Input byte and/or 32 Output byte (per IO-Link port)	
Port class	4 × A (port X1...X4), 4 × B (port X5...X8, galvanically separated, max. 4 A per module)	
Specification	IO-Link Master V1.1	
<b>Input</b>		
Sensor supply US	24 V DC (EN 61131-2), max. 500 mA (M12 female), short-circuit and overload protected	
Type	for 3-wire sensors or mechanical switches, PNP, IO-Link Devices	
<b>Output</b>		
Actuator supply UA	24 V DC (EN 61131-2), max. 9 A	
Switching current per output	max. 0.5 A (PIN 4, X1...X8), short-circuit and overload protected	
<b>Parameterization</b>		
PIN 4	Input (port X1...X8); Output (port X1...X8); IO-Link Master (port X1...X8)	
PIN 2	Input (port X1...X4)	
<b>General data</b>		
Protection	IP67	
Mounting method	2-hole screw mounting	
Temperature range	-20...+70 °C	
<b>Dimension drawing</b>		

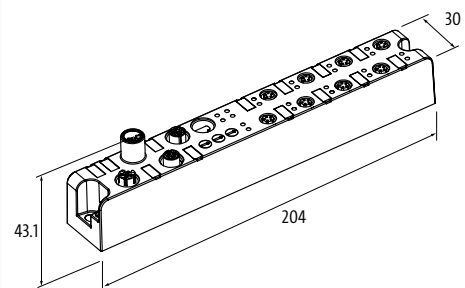
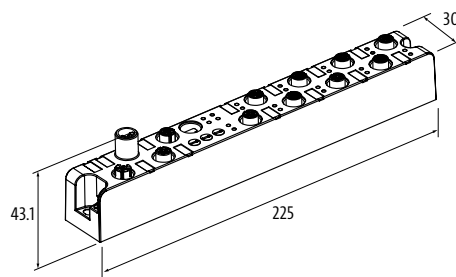

Notes

Blind plug/caps			Art-No.
	<b>Screw plug M12 × 1 mm (for female)</b> Plastic, hex without gasket	Quantity: 10 pcs.	58627
Labeling accessories			Art-No.
	<b>Label plates</b> 20 × 8 mm	(20 pieces per plate)	55318
	<b>Label plate (KM 4)</b> 5 × 10 mm		90931



# IMPACT67 COMPACT I/O MODULES FOR THE FIELD

- Application oriented
- Easy to Install
- Cost-effective

## ECONOMIC DECENTRALIZATION

Impact67 is the perfect fieldbus solution for basic applications that need to be cost-effective. The modules in this series are available with different bus protocols, they feature pluggable connections, diagnostics and IP67 tested seals.

This makes Impact67 the perfect choice for an electrical engineer whose objective is to minimize costs while maintaining digital inputs and outputs under ordinary conditions.

## FOCUSED ON ESSENTIALS

- Single channel diagnostic via LED – don't look for errors, find them
- Group diagnostics via the bus – easy remote diagnostics
- Port-related shut off – only the affected port is shut off



EtherNet/IP

EtherCAT

CANopen

DeviceNet

IO-Link

## Impact67 I/O Modules

 <p><b>Impact67-P</b> • Digital I/Os</p>  <p>Page 4.6.1</p>	 <p><b>Impact67-PN</b> • Multifunctional I/Os • Digital I/Os • IO-Link</p>  <p>IO-Link</p> <p>Page 4.6.2</p>
 <p><b>Impact67-E</b> • Multifunctional I/Os • Digital I/Os • IO-Link</p>  <p>Page 4.6.5</p>	 <p><b>Impact67-EC</b> • Digital I/Os</p>  <p>Page 4.6.8</p>
 <p><b>Impact67-C</b> • Digital I/Os</p>  <p>Page 4.6.9</p>	 <p><b>Impact67-DN</b> • Digital I/Os</p>  <p>Page 4.6.10</p>



# IMPACT67

## Basic diagnostic



### Impact67-P

DI16

### Impact67-P

DI8/DO8 - 2 A

### Impact67-P

DO8 - 2 A

### Impact67-P

DO16 - 0.5 A



Approvals:

Order Data	Art-No.	Art-No.	Art-No.	Art-No.
DI16	55345			
DI8/DO8 - 2 A		55346		
DO8 - 2 A			55347	
DO16 - 0.5 A				55348
<b>Connections</b>				
Fieldbus	PROFIBUS 12 Mbit/s; M12, B-coded			
Sensor-system/actuator supply	7/8", 5-pole, 2 x max. 9 A			
I/O ports	M12, 5-pole, A-coded			
<b>PROFIBUS</b>				
Addressing	Rotary switch 3...99			
<b>Input</b>				
Sensor supply US	24 V DC (EN 61131-2), max. 200 mA (M12 female), short-circuit and overload protected		-	
Type	for 3-wire sensors or mechanical switches, PNP		-	
<b>Output</b>				
Switching current per output	-	max. 2 A (short-circuit and overload protected)		max. 0.5 A (short-circuit and overload protected)
<b>General data</b>				
Protection	IP67			
Mounting method	2 hole screw mounting, compatible with I/O modules of MVK model range			
Temperature range	0...+55 °C (storage temperature -25...+70 °C)			
<b>Dimension drawing</b>				

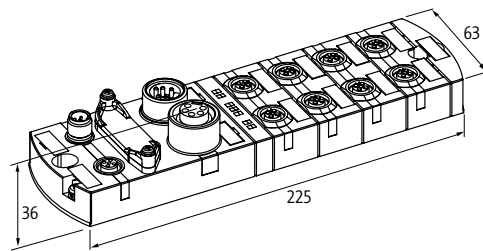

<b>Notes</b>	
--------------	--

# IMPACT67

## Basic diagnostic



### Impact67-PN

DI16

### Impact67-PN

DI8/DO8 - 2 A

### Impact67-PN

DO8 - 2 A

### Impact67-PN

DO16 - 0.5 A



Order Data	Art-No.	Art-No.	Art-No.	Art-No.
DI16	55091			
DI8/DO8 - 2 A		55092		
DO8 - 2 A			55093	
DO16 - 0.5 A				55094
<b>Connections</b>				
Fieldbus	Ethernet 10/100 Mbit/s; M12, D-coded			
Sensor-system/actuator supply	7/8", 5-pole, 2 × max. 9 A			
I/O ports	M12, 5-pole, A-coded			
<b>PROFINET</b>				
Addressing	DCP			
<b>Input</b>				
Sensor supply US	24 V DC (EN 61131-2), max. 200 mA (M12 female), short-circuit and overload protected		-	
Type	for 3-wire sensors or mechanical switches, PNP		-	
<b>Output</b>				
Switching current per output	-	max. 2 A (short-circuit and overload protected)		max. 0.5 A (short-circuit and overload protected)
<b>General data</b>				
Protection	IP67			
Mounting method	2 hole screw mounting, compatible with I/O modules of MVK model range			
Temperature range	-25...+55 °C (storage temperature -25...+70 °C)			
<b>Dimension drawing</b>				

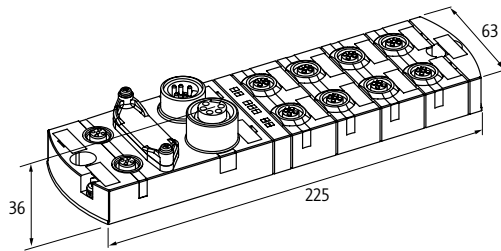

## Notes

# IMPACT67

## Expanded diagnostic



### Impact67-PN

DIO16 IRT



Order Data	Art-No.
DIO16 IRT	55130
Connections	
Fieldbus	Ethernet 10/100 Mbit/s; M12, D-coded
Sensor-system/actuator supply	7/8", 5-pole, 2 × max. 9 A
I/O ports	M12, 5-pole, A-coded
PROFINET	
FSU (Fast-Start-Up)	max. 500 ms
Shared Device/Input	yes, for 2 controls
Profinet Netload Class	III
Specification	V2.3, Conformance Class C (IRT)
Addressing	DCP
Input	
Sensor supply US	24 V DC (EN 61131-2), max. 200 mA (M12 female), short-circuit and overload protected
Type	for 3-wire sensors or mechanical switches, PNP
Output	
Actuator supply UA	24 V DC (EN 61131-2), max. 9 A
Switching current per output	max. 1.6 A (short-circuit and overload protected)
Lamp load	10 W
Parameterization	
PIN 4	Input/Output (port X0...X7)
PIN 2	Input/Output (port X0...X7)
General data	
Protection	IP67
Mounting method	2-hole screw mounting
Temperature range	-25...+55 °C (storage temperature -25...+70 °C)
Dimension drawing	

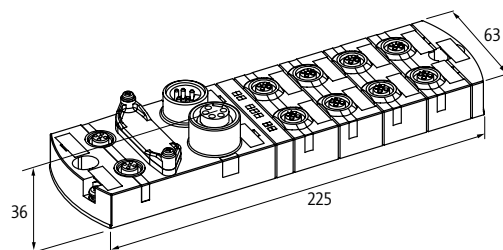

Notes

# IMPACT67

## Expanded diagnostic



### Impact67-PN IO-Link

DIO14 IOL2 IRT



### Impact67-PN IO-Link

DIO12 IOL4 IRT



Order Data	Art-No.	Art-No.
DIO14 IOL2 IRT	55131	
DIO12 IOL4 IRT		55132
<b>Connections</b>		
Fieldbus	Ethernet 10/100 Mbit/s; M12, D-coded	
Sensor-system/actuator supply	7/8", 5-pole, 2 × max. 9 A	
I/O ports	M12, 5-pole, A-coded	
<b>PROFINET</b>		
FSU (Fast-Start-Up)	max. 500 ms	
Shared Device/Input	yes, for 2 controls	
Profinet Netload Class	III	
Specification	V2.3, Conformance Class C (IRT)	
Addressing	DCP	
<b>IO-Link</b>		
IO-Link	2 × Master	4 × Master
Operating modes	COM1; COM2; COM3 (automatic)	
Transfer parameters	32 Byte (via IO-Link Port)	
Port class	Class B (not galvanically separated)	Class A + B (not galvanically separated)
Specification	IO-Link Master V1.12	
<b>Input</b>		
Sensor supply US	24 V DC (EN 61131-2), max. 200 mA (M12 female), short-circuit and overload protected	
Type	for 3-wire sensors or mechanical switches, PNP, IO-Link Devices	
<b>Output</b>		
Actuator supply UA	24 V DC (EN 61131-2), max. 9 A	
Switching current per output	max. 1.6 A (short-circuit and overload protected)	
Lamp load	10 W	
<b>Parameterization</b>		
PIN 4	Input (port X0...X7); Output (port X0...X4, X6); IO-Link Master (port X5, X7)	Input (port X0...X7); Output (port X0, X2, X4, X6); IO-Link Master (port X1, X3, X5, X7)
PIN 2	Input/Output (port X0...X7); U-Actuator IO-Link Class B (port X5, X7)	
<b>General data</b>		
Protection	IP67	
Mounting method	2-hole screw mounting	2 hole screw mounting, compatible with I/O modules of MVK model range
Temperature range	-25...+55 °C (storage temperature -25...+70 °C)	
<b>Dimension drawing</b>		

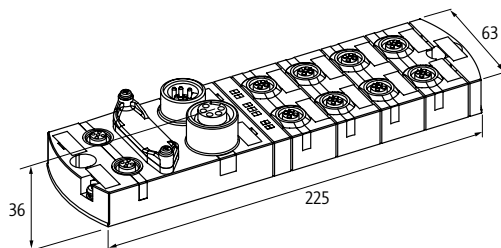

## Notes

# IMPACT67

Basic diagnostic

EtherNet/IP

**Impact67-E**

DI16

**Impact67-E**

DI8/DO8 - 2 A

**Impact67-E**

DO8 - 2 A

**Impact67-E**

DO16 - 0.5 A



Approvals:  

Order Data	Art-No.	Art-No.	Art-No.	Art-No.
DI16	55085			
DI8/DO8 - 2 A		55086		
DO8 - 2 A			55087	
DO16 - 0.5 A				55088
<b>Connections</b>				
Fieldbus	Ethernet 10/100 Mbit/s; M12, D-coded			
Sensor-system/actuator supply	7/8", 5-pole, 2 × max. 9 A			
I/O ports	M12, 5-pole, A-coded			
<b>EtherNet/IP</b>				
Addressing	DHCP, BOOTP or IP address by rotary switch			
<b>Input</b>				
Sensor supply US	24 V DC (EN 61131-2), max. 200 mA (M12 female), short-circuit and overload protected		-	
Type	for 3-wire sensors or mechanical switches, PNP		-	
<b>Output</b>				
Switching current per output	-	max. 2 A (short-circuit and overload protected)	max. 0.5 A (short-circuit and overload protected)	
<b>General data</b>				
Protection	IP67			
Mounting method	2 hole screw mounting, compatible with I/O modules of MVK model range			
Temperature range	-25...+55 °C (storage temperature -25...+70 °C)		0...+55 °C (storage temperature -25...+70 °C)	
<b>Dimension drawing</b>				

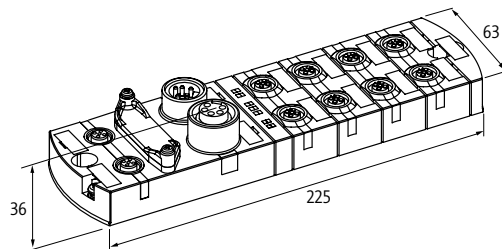

<b>Notes</b>	
--------------	--

# IMPACT67

Expanded diagnostic

EtherNet/IP™

Approvals:  

## Impact67-E

DIO8 (DIO8)  
DLR (Device Level Ring)

## Impact67-E

DIO16  
DLR (Device Level Ring)



Order Data	Art-No.	Art-No.
DIO8 (DIO8)	55089	
DIO16		55142
<b>Connections</b>		
Fieldbus	Ethernet 10/100 Mbit/s; M12, D-coded	
Sensor-system/actuator supply	7/8", 5-pole, 2 × max. 9 A	7/8", 4-pole, 2 × max. 9 A
I/O ports	M12, 5-pole, A-coded	
<b>EtherNet/IP</b>		
Addressing	DHCP, BOOTP or IP address by rotary switch	DHCP, BOOTP or IP address by DIP switch
DLR (Device Level Ring)	yes	
QC (Quick Connect)	–	max. 360 ms
Multiple connections	–	yes
CIP Sync	–	yes
Composite Test Revision	–	CT14
<b>Input</b>		
Sensor supply US	24 V DC (EN 61131-2), max. 200 mA (M12 female), short-circuit and overload protected	
Type	for 3-wire sensors or mechanical switches, PNP	
<b>Output</b>		
Actuator supply UA	24 V DC (EN 61131-2), max. 9 A	
Switching current per output	max. 1.6 A (short-circuit and overload protected)	
Lamp load	10 W	
<b>Parameterization</b>		
PIN 4	Input/Output (port X0...X7)	
PIN 2	Input/Output (port X0...X7)	
<b>General data</b>		
Protection	IP67	
Mounting method	2 hole screw mounting, compatible with I/O modules of MVK model range	2-hole screw mounting
Temperature range	-25...+55 °C (storage temperature -25...+70 °C)	-25...+55 °C (storage temperature -40...+85 °C)
<b>Dimension drawing</b>		

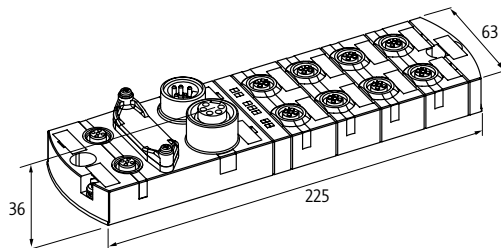

Notes

# IMPACT67

Expanded diagnostic

EtherNet/IP  IO-Link

## Impact67-E IO-Link

DIO14 IOL2  
DLR (Device Level Ring)

## Impact67-E IO-Link

DIO12 IOL4  
DLR (Device Level Ring)



Approvals:  

Order Data	Art-No.	Art-No.
DIO14 IOL2	55143	
DIO12 IOL4		55144
<b>Connections</b>		
Fieldbus	Ethernet 10/100 Mbit/s; M12, D-coded	
Sensor-system/actuator supply	7/8", 4-pole, 2 × max. 9 A	
I/O ports	M12, 5-pole, A-coded	
<b>EtherNet/IP</b>		
Addressing	DHCP, BOOTP or IP address by DIP switch	
QC (Quick Connect)	max. 360 ms	
Multiple connections	yes	
CIP Sync	yes	
Composite Test Revision	CT14	
DLR (Device Level Ring)	yes	
<b>IO-Link</b>		
IO-Link	2 × Master	4 × Master
Operating modes	COM1; COM2; COM3 (automatic)	
Transfer parameters	32 Byte (via IO-Link Port)	
Port class	Class B (not galvanically separated)	
Specification	IO-Link Master V1.12	
<b>Input</b>		
Sensor supply US	24 V DC (EN 61131-2), max. 200 mA (M12 female), short-circuit and overload protected	
Type	for 3-wire sensors or mechanical switches, PNP, IO-Link Devices	
<b>Output</b>		
Actuator supply UA	24 V DC (EN 61131-2), max. 9 A	
Switching current per output	max. 1.6 A (short-circuit and overload protected)	
Lamp load	10 W	
<b>Parameterization</b>		
PIN 4	Input/Output (port X0...X7); IO-Link Master (port X6, X7)	Input/Output (port X0...X7); IO-Link Master (port X4...X7)
PIN 2	Input/Output (port X0...X7); U-Actuator IO-Link Class B (port X6, X7)	Input/Output (port X0...X7); U-Actuator IO-Link Class B (port X4...X7)
<b>General data</b>		
Protection	IP67	
Mounting method	2-hole screw mounting	
Temperature range	-25...+55 °C (storage temperature -40...+85 °C)	
<b>Dimension drawing</b>		

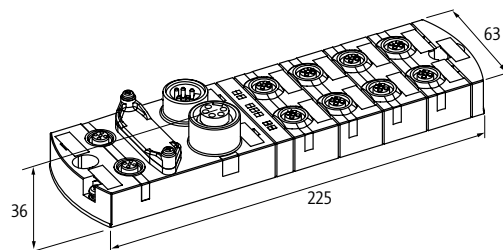

Notes

# IMPACT67

Basic diagnostic

EtherCAT

Approvals:  

**Impact67-EC**  
DI16

**Impact67-EC**  
DI8/DO8 - 2 A

**Impact67-EC**  
DO8 - 2 A

**Impact67-EC**  
DO16 - 0.5 A



Order Data	Art-No.	Art-No.	Art-No.	Art-No.
DI16	55081			
DI8/DO8 - 2 A		55082		
DO8 - 2 A			55083	
DO16 - 0.5 A				55084

Connections				
Fieldbus	Ethernet 10/100 Mbit/s; M12, D-coded			
Sensor-system/actuator supply	7/8", 5-pole, 2 × max. 9 A			
I/O ports	M12, 5-pole, A-coded			
EtherCAT				
Addressing	automatic or Device ID by rotary switch			
Input				
Sensor supply US	24 V DC (EN 61131-2), max. 200 mA (M12 female), short-circuit and overload protected		-	
Type	for 3-wire sensors or mechanical switches, PNP		-	
Output				
Switching current per output	-	max. 2 A (short-circuit and overload protected)		max. 0.5 A (short-circuit and overload protected)
General data				
Protection	IP67			
Mounting method	2 hole screw mounting, compatible with I/O modules of MVK model range			
Temperature range	-25...+55 °C (storage temperature -25...+70 °C)			0...+55 °C (storage temperature -25...+70 °C)
Dimension drawing				

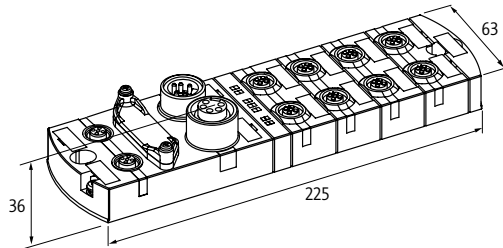

Notes



# IMPACT67

Basic diagnostic

**CANopen**

**Impact67-C**

DI16

**Impact67-C**

DI8/DO8 - 2 A

**Impact67-C**

DO8 - 2 A

**Impact67-C**

DO16 - 0.5 A



Approvals:  

Order Data	Art-No.	Art-No.	Art-No.	Art-No.
DI16	55075			
DI8/DO8 - 2 A		55076		
DO8 - 2 A			55077	
DO16 - 0.5 A				55078
<b>Connections</b>				
Fieldbus	CAN 1 Mbit/s; M12, A-coded			
Sensor-system/actuator supply	7/8", 5-pole, 2 × max. 9 A			
I/O ports	M12, 5-pole, A-coded			
<b>CANopen</b>				
Addressing	Rotary switch 1...99			
<b>Input</b>				
Sensor supply US	24 V DC (EN 61131-2), max. 200 mA (M12 female), short-circuit and overload protected		-	
Type	for 3-wire sensors or mechanical switches, PNP	-		
<b>Output</b>				
Switching current per output	-	max. 2 A (short-circuit and overload protected)	max. 0.5 A (short-circuit and overload protected)	
<b>General data</b>				
Protection	IP67			
Mounting method	2 hole screw mounting, compatible with I/O modules of MVK model range			
Temperature range	-25...+70 °C (storage temperature -25...+70 °C)			
<b>Dimension drawing</b>				

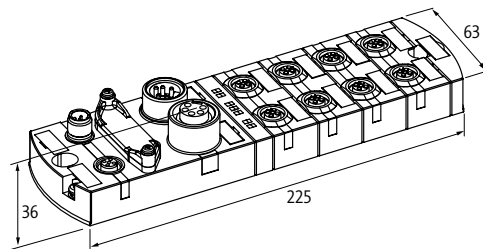

<b>Notes</b>	
--------------	--

# IMPACT67

Basic diagnostic

DeviceNet

**Impact67-DN**

DI16

**Impact67-DN**

DI8/DO8 - 2 A

**Impact67-DN**

DO8 - 2 A

**Impact67-DN**

DO16 - 0.5 A





Approvals:  

Order Data	Art-No.	Art-No.	Art-No.	Art-No.
DI16	55071			
DI8/DO8 - 2 A		55072		
DO8 - 2 A			55073	
DO16 - 0.5 A				55074

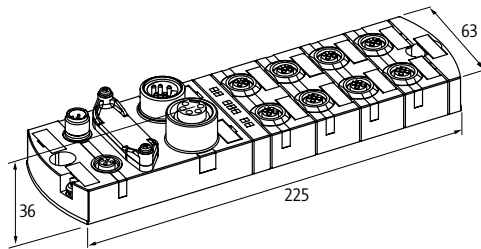
Connections	
Fieldbus	DN 125 kbit/s; 250 kbit/s; 500 kbit/s; M12, A-coded
Sensor-system/actuator supply	7/8", 5-pole, 2 × max. 9 A
I/O ports	M12, 5-pole, A-coded
DeviceNet	
Addressing	Rotary switch 0...63
Input	
Sensor supply US	24 V DC (EN 61131-2), max. 200 mA (M12 female), short-circuit and overload protected
Type	for 3-wire sensors or mechanical switches, PNP
Output	
Switching current per output	max. 2 A (short-circuit and overload protected) / max. 0.5 A (short-circuit and overload protected)
General data	
Protection	IP67
Mounting method	2 hole screw mounting, compatible with I/O modules of MVK model range
Temperature range	-25...+70 °C (storage temperature -25...+70 °C)
Dimension drawing	



Notes

Accessories			Art-No.
	<p><b>Label plates</b> 20 × 8 mm</p>	<p>(20 pieces per plate)</p>	<p><b>55318</b></p>
	<p><b>Screw plug M12 × 1 mm (for female)</b> Plastic, hex without gasket</p>	<p>Quantity: 10 pcs.</p>	<p><b>58627</b></p>
	<p><b>Screw plug 7/8" (for male)</b> Plastic</p>		<p><b>55385</b></p>

# IO-LINK DEVICES

## INTELLIGENT NETWORKING

- Flexible
- Easy handling
- Economical

### IO-LINK ANALOG CONVERTER

The IO-Link analog converter from Murrelektronik can be used to connect regular analog sensors and actuators easily to the IO-Link master.

### IO-LINK COUPLER

The IO-Link inductive couplers from Murrelektronik are designed for a non-contact transmission of energy and bi-directional IO-Link communication through an air gap. This prevents mechanical wear and is ideally suited to replace intensively stressed plug-in or looped connections.

### IO-LINK HUB

The IO-Link hubs from Murrelektronik can be used to connect several digital sensors and actuators easily to the IO-Link master ports via a standard sensor cable.

 **IO-Link**  
by Murrelektronik

## IO-LINK DEVICES



### IO-Link/Analog Converters

- Analog inputs
- Analog outputs

Page 4.7.1



### IO-Link Coupler

- Primary
- Secondary

Page 4.7.7



### IO-Link Hubs

- Metal version
- Plastic version

Page 4.7.8

# IO-LINK DEVICES

## Analog inputs

– Plug & Play

– IO-Link V1.1

 IO-Link

Approvals: 

## IO-Link/Analog Converter

Current



### Contact layout

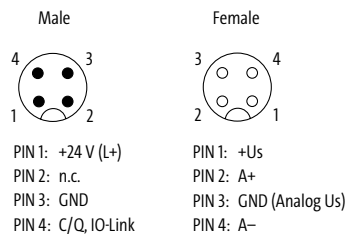

### Order Data

INPUT: 0...20 mA	Art-No. 5000-00501-110000
INPUT: 4...20 mA	5000-00501-111000

### Connections

IO-Link	M12 (male) 5-pole, A-coded
Analog input	M12 (female) 5-pole, A-coded, shielded

### Module Supply

Operating voltage	24 V DC (18...30 V DC)
-------------------	------------------------

### IO-Link

Specification	IO-Link V1.1
Operating modes	COM2 (38.4 kBit/s)
Port class	A
Cycle time	min. 2.3 ms
Data width	16 Bit / 2 Byte

### Input

Sensor supply US	24 V DC (EN 61131-2), max. 200 mA
Resolution (analog)	15 Bit + sign
Accuracy	0.10% (25° C)
Conversion time (analog)	max. 5 ms

### Parameterization

Diagnostics	lower limit, upper limit, over heated, supply over voltage, supply under voltage, defective device, sensor supply over current, overrun
-------------	---

### General data

Protection	IP65/IP67
Temperature range	-30...+70 °C (storage temperature -40...+85 °C)

### Dimension drawing

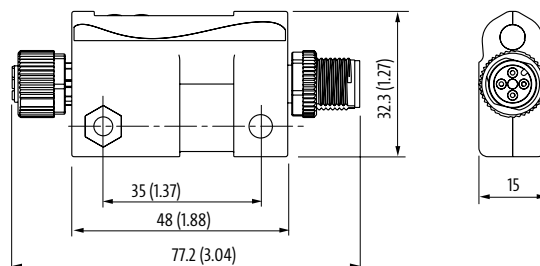

### Notes

# IO-LINK DEVICES

## Analog inputs

– Plug & Play

– IO-Link V1.1

 IO-Link

Approvals: 

## IO-Link/Analog Converter

Voltage



### Contact layout

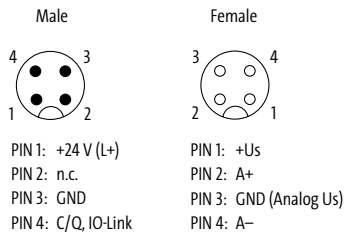

Order Data	Art-No.
INPUT: 0...10 V	5000-00501-1200000
INPUT: -10...+10 V	5000-00501-1210000

Connections	
IO-Link	M12 (male) 5-pole, A-coded
Analog input	M12 (female) 5-pole, A-coded, shielded

Module Supply	
Operating voltage	24 V DC (18...30 V DC)

IO-Link	
Specification	IO-Link V1.1
Operating modes	COM2 (38.4 kBit/s)
Port class	A
Cycle time	min. 2.3 ms
Data width	16 Bit / 2 Byte

Input	
Sensor supply US	24 V DC (EN 61131-2), max. 200 mA
Resolution (analog)	15 Bit + sign
Accuracy	0.10% (25° C)
Conversion time (analog)	max. 5 ms

Parameterization	
Diagnostics	lower limit, upper limit, over heated, supply over voltage, supply under voltage, defective device, sensor supply over current, overrun

General data	
Protection	IP65/IP67
Temperature range	-30...+70 °C (storage temperature -40...+85 °C)

### Dimension drawing

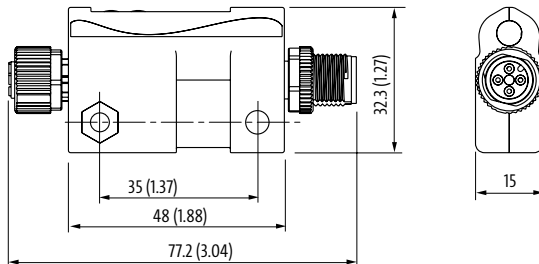

### Notes

# IO-LINK DEVICES

## Analog inputs

– Multifunctional

– IO-Link V1.1

 IO-Link

Approvals: 

## IO-Link/Analog Converter

Current/Voltage



### Contact layout

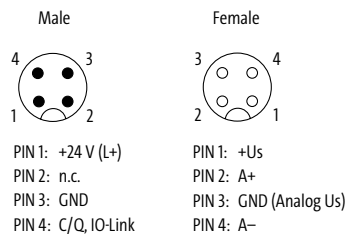

### Order Data

INPUT: 0...20 mA, 4...20 mA, 0...10 V, -10...+10 V

### Art-No.

5000-00501-1300001

### Connections

IO-Link M12 (male) 5-pole, A-coded  
 Analog input M12 (female) 5-pole, A-coded, shielded

### Module Supply

Operating voltage 24 V DC (18...30 V DC)

### IO-Link

Specification IO-Link V1.1  
 Operating modes COM2 (38.4 kBit/s)  
 Port class A  
 Cycle time min. 2.3 ms  
 Data width 16 Bit / 2 Byte

### Input

Sensor supply US 24 V DC (EN 61131-2), max. 200 mA  
 Resolution (analog) 15 Bit + sign  
 Accuracy 0.10% (25° C)  
 Conversion time (analog) max. 5 ms

### Parameterization

Diagnostics 2 Byte

### General data

Protection IP65/IP67  
 Temperature range -30...+70 °C (storage temperature -40...+85 °C)

### Dimension drawing

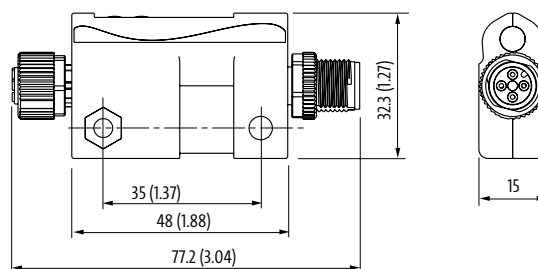

### Notes

# IO-LINK DEVICES

## Analog outputs

– Plug & Play

– IO-Link V1.1

 IO-Link

Approvals:  Listed

## IO-Link/Analog Converter

Current



### Contact layout

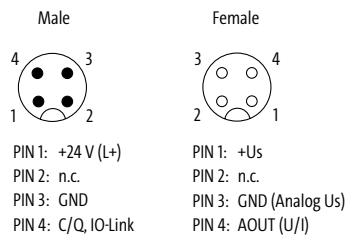

Order Data	Art-No.
OUTPUT: 0...20 mA	5000-00501-2100000
OUTPUT: 4...20 mA	5000-00501-2110000

### Connections

IO-Link	M12 (male) 5-pole, A-coded
Analog output	M12 (female) 5-pole, A-coded, shielded

### Module Supply

Operating voltage	24 V DC (18...30 V DC)
-------------------	------------------------

### IO-Link

Specification	IO-Link V1.1
Operating modes	COM2 (38.4 kBit/s)
Port class	A
Cycle time	min. 2.3 ms
Data width	16 Bit / 2 Byte

### Output

Actuator supply UA	24 V DC (EN 61131-2), max. 200 mA
Resolution (analog)	15 Bit + sign
Type	2-, 3-, 4-wire technology
Accuracy	0.10% (25° C)
Conversion time (analog)	max. 5 ms
Over voltage protection	30 V DC

### Parameterization

Diagnostics	lower limit, upper limit, over heated, supply over voltage, supply under voltage, defective device, sensor cable break, sensor supply over current, overrun
-------------	---

### General data

Protection	IP65/IP67
Temperature range	-30...+70 °C (storage temperature -40...+85 °C)

### Dimension drawing

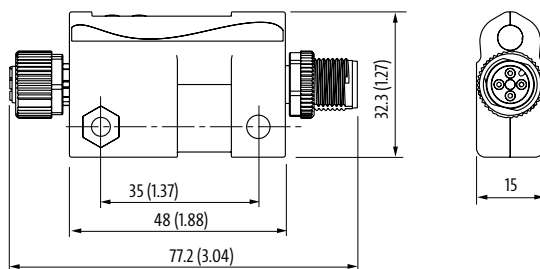

### Notes



# IO-LINK DEVICES

## Analog outputs

– Plug & Play

– IO-Link V1.1

 IO-Link

Approvals: 

## IO-Link/Analog Converter

Voltage



### Contact layout

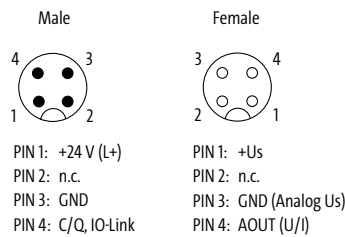

### Order Data

OUTPUT: 0...10 V

Art-No.

5000-00501-220000

OUTPUT: -10...+10 V

5000-00501-221000

### Connections

IO-Link M12 (male) 5-pole, A-coded

Analog output M12 (female) 5-pole, A-coded, shielded

### Module Supply

Operating voltage 24 V DC (18...30 V DC)

### IO-Link

Specification IO-Link V1.1

Operating modes COM2 (38.4 kBit/s)

Port class A

Cycle time min. 2.3 ms

Data width 16 Bit / 2 Byte

### Output

Actuator supply UA 24 V DC (EN 61131-2), max. 200 mA

Resolution (analog) 15 Bit + sign

Type 2-, 3-, 4-wire technology

Accuracy 0.10% (25° C)

Conversion time (analog) max. 5 ms

Over voltage protection 30 V DC

### Parameterization

Diagnostics lower limit, upper limit, over heated, supply over voltage, supply under voltage, defective device, sensor cable break, sensor supply over current, overrun

### General data

Protection IP65/IP67

Temperature range -30...+70 °C (storage temperature -40...+85 °C)

### Dimension drawing

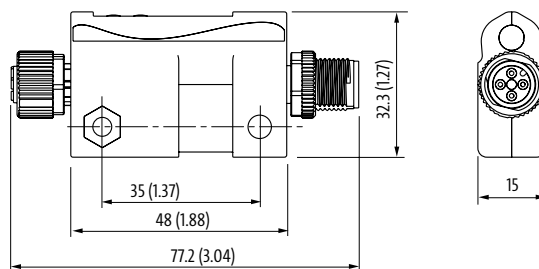

### Notes

# IO-LINK DEVICES

## Analog outputs

– Multifunctional

– IO-Link V1.1

 IO-Link

Approvals:  Listed

## IO-Link/Analog Converter

Current/Voltage



### Contact layout

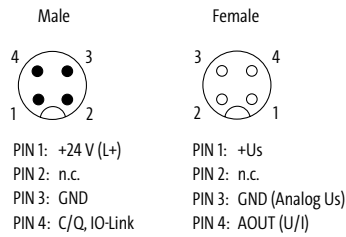

<b>Order Data</b>	<b>Art-No.</b>
OUTPUT: 0...20 mA, 4...20 mA, 0...10 V, -10...+10 V	<b>5000-00501-2300001</b>

### Connections

IO-Link	M12 (male) 5-pole, A-coded
Analog output	M12 (female) 5-pole, A-coded, shielded

### Module Supply

Operating voltage	24 V DC (18...30 V DC)
-------------------	------------------------

### IO-Link

Specification	IO-Link V1.1
Operating modes	COM2 (38.4 kBit/s)
Port class	A
Cycle time	min. 2.3 ms
Data width	16 Bit / 2 Byte

### Output

Actuator supply UA	24 V DC (EN 61131-2), max. 200 mA
Resolution (analog)	15 Bit + sign
Type	2-, 3-, 4-wire technology
Accuracy	0.10% (25° C)
Conversion time (analog)	max. 5 ms
Over voltage protection	30 V DC

### Parameterization

Diagnostics	lower limit, upper limit, over heated, supply over voltage, supply under voltage, defective device, sensor cable break, sensor supply over current, overrun
-------------	---

### General data

Protection	IP65/IP67
Temperature range	-30...+70 °C (storage temperature -40...+85 °C)

### Dimension drawing

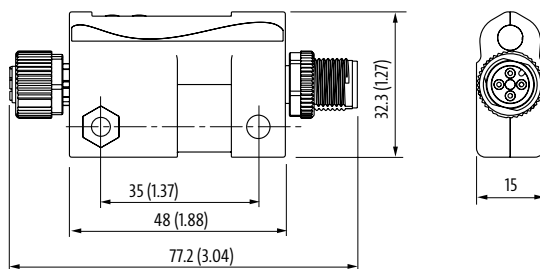

### Notes

## IO-LINK DEVICES

### IO-Link V1.1



### IO-Link Coupler (prim.)



### IO-Link Coupler (sec.)

Connection cable L = 300 mm



Order Data	Art-No.	Art-No.
Primary	59450	
Secondary		59451
Accessories	Art-No.	
M30 holder		59452
Connections		
IO-Link	M12 (male) 4-pole, A-coded	M12 (female) 4-pole, A-coded
Technical Data		
Nominal distance	0...7 mm (prim./sec.)	
Standby power (coupled)	4 W	
Standby power (uncoupled)	1 W	
Short circuit protection	yes	
Invers-polarity protection	yes	
Start-/coupling time		10 ms
Rotation	1250 rpm	
Standby time		160 ms
Supply (prim.)		
Operating voltage	24 V DC ±10%	–
Operating current	750 mA	–
Output (sec.)		
Operating voltage	–	24 V DC ±10%
Output current	–	500 mA
Highest current	–	2.4 A (0.1 ms); 10 A (0.02 ms)
IO-Link		
Specification	IO-Link V1.1	
Operating modes	COM2 (38.4 kBit/s)	
Port class	A	
General data		
Protection	IP67/IP68	
Temperature range	-20...+55 °C	
Dimension drawing		

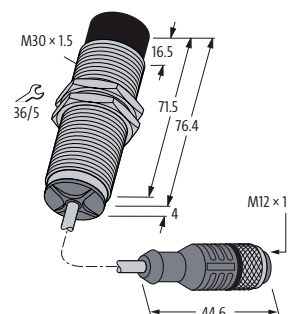
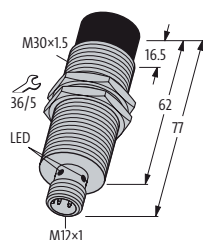

### Notes

## IO-LINK DEVICES

### Expanded diagnostic

– IO-Link V1.1

– Single channel diagnostic

 IO-Link

### IO-Link Hub

Galvanic isolation

### IO-Link Hub



Order Data	Art-No.	Art-No.
DI8 DO8 IOL - K3	55518	
DI16 IOL		55519
Internal communication		
Current consumption	max. 35 mA	
LED display	US: sensor supply (green: OK); IOL: (green: OK); UA: actuator supply (green: OK)	US: sensor supply (green: OK); IOL: (green: OK)
IO-Link		
IO-Link	Device	
Operating modes	COM2 (38.4 kBaud)	
Transfer parameters	1 Byte (Inputs), 1 Byte (Outputs), 2 Byte (Diagnostic)	2 Byte (Inputs), 1 Byte (Diagnostic)
Port class	B	A
Specification	IO-Link V1.1	
Cycle time	2.3 ms	
Input		
Sensor supply US	24 V DC (EN 61131-2), max. 100 mA (M12 female), short-circuit and overload protected	
Type	PNP (EN 61131-2) Type 3	
Input filter	1 ms	
Input delay time	max. 8 ms (incl. IO-Link cycle time)	
Output		
Actuator supply UA	24 V DC (EN 61131-2), max. 4 A	–
Switching current per output	max. 0.4 A (short-circuit and overload protected)	–
Parameterization		
PIN 2	Input (port 0...3); Output (port 4...7)	Input
PIN 4	Input (port 0...3); Output (port 4...7)	Input
General data		
Protection	IP67	
Mounting method	4 hole screw mounting	
Temperature range	-25...+70 °C (storage temperature -40...+70 °C)	
Dimension drawing		

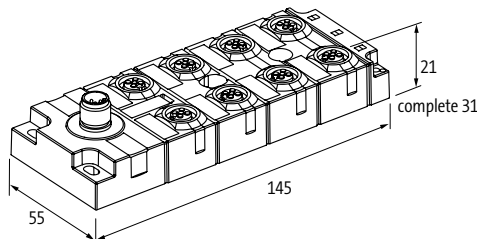

### Notes

## IO-LINK DEVICES

### IO-Link V1.1



### IO-Link Hub





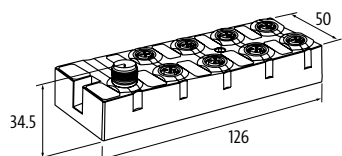



Order Data	Art-No.	Art-No.
D18 DO8 IOL	59402	
D116 IOL		59401
<b>Internal communication</b>		
Current consumption	max. 35 mA	
LED display	US-IOL: sensor supply-IOL (green: OK); UA: actuator supply (green: OK)	US: sensor supply (green: OK); IOL: (green: OK)
<b>IO-Link</b>		
IO-Link	Device	
Operating modes	COM2 (38.4 kBaud)	
Transfer parameters	1 Byte (Inputs), 1 Byte (Outputs), 2 Byte (Diagnostic)	2 Byte (Inputs), 1 Byte (Diagnostic)
Port class	B	A
Specification	IO-Link V1.1	
Cycle time	2.3 ms	
<b>Input</b>		
Sensor supply US	24 V DC (EN 61131-2), max. 100 mA (M12 female), short-circuit and overload protected	
Type	PNP (EN 61131-2) Type 3	
Input filter	1 ms	
Input delay time	max. 8 ms (incl. IO-Link cycle time)	
<b>Output</b>		
Actuator supply UA	24 V DC (EN 61131-2), max. 4 A	–
Switching current per output	max. 0.4 A (short-circuit and overload protected)	–
<b>Parameterization</b>		
PIN 2	Input (port 0...3); Output (port 4...7)	Input
PIN 4	Input (port 0...3); Output (port 4...7)	Input
<b>General data</b>		
Protection	IP67	
Mounting method	2-hole screw mounting	
Temperature range	-25...+70 °C (storage temperature -40...+70 °C)	
<b>Dimension drawing</b>		



Notes

## IO-LINK DEVICES

Accessories			Art-No.
	<b>Label plates</b> 20 × 8 mm	(20 pieces per plate)	55318
	<b>Screw plug M12 × 1 mm (for female)</b> Plastic, hex without gasket	Quantity: 10 pcs.	58627
	<b>M30 holder</b>		59452
	<b>Holding plate</b> for T-couplers M12 (SlimLine)	without mounting set	7000-99061-000000
	<b>Holding plate</b> for T-couplers M12 (SlimLine)	with mounting set	7000-99062-000000
	<b>T-coupler (Slim Line)</b> IO-Link IO-Link supply power		7000-42771-000000



# MASI FOR THE CONTROL CABINET

- High signal density in a minimum amount of space
- Pluggable insulation displacement or spring clamp connections
- Sensor power supply from AS-Interface or 24 V DC

## MASI – THE CLEVER AS-INTERFACE SYSTEM FROM MURRELEKTRONIK

The modules are designed in a way that the wiring method with single strands is optimally supported in order to offer the user the best possible benefit during installation, commissioning and maintenance.

The design according to the latest AS-Interface specification 3.0 and the AS-Interface certificate with worldwide validity guarantee the user interoperability and a high investment security. Furthermore, safety shutdowns according to EN 13849-1 up to PL d can be realized using a special K3 module.



### ➤ MASI

I/O modules, accessories and accompanying information material regarding MASI can be found in the **online shop**:

➤ [shop.murrelektronik.com](http://shop.murrelektronik.com)

## Gateway



Gateway Singlemaster



Page 4.8.1



Gateway Doublemaster



Page 4.8.1

## MAS100/MAS120



MAS100

- Digital inputs/outputs
- Degree of protection IP00

Page 4.8.2



MAS120

- Digital inputs/outputs
- Passively safe outputs
- Degree of protection IP20

Page 4.8.3

## Power Supply Units



Primary switched power supply

- Single-phase, three-phase

Page 4.8.4





# MASI CONTROL CABINET

stay connected

PROFIBUS DP			Art-No.
	<b>Gateway-Singlemaster</b> AS-Interface/PROFIBUS DP No. of slaves ASI-Power 24 Serial interface/diagnostic AS-Interface data decoupling integrated	Protection IP20 max. 62 Specification 3.0 - Protection AS-i side, 4 A	56471
PROFINET			Art-No.
	<b>Gateway-Singlemaster</b> AS-Interface/PROFINET No. of slaves ASI-Power 24 Serial interface/diagnostic AS-Interface data decoupling integrated	Protection IP20 max. 62 Specification 3.0 RJ45/Fieldbus Protection AS-i side, 4 A	56470
EtherNet/IP			Art-No.
	<b>Gateway-Singlemaster</b> AS-Interface/EtherNet/IP No. of slaves ASI-Power 24 Serial interface/diagnostic AS-Interface data decoupling integrated	Protection IP20 max. 62 Specification 3.0 RJ45/Fieldbus Protection AS-i side, 4 A	56469
CC-Link			Art-No.
	<b>Gateway-Singlemaster</b> AS-Interface/CC-Link No. of slaves ASI-Power 24 Serial interface/diagnostic AS-Interface data decoupling integrated	Protection IP20 max. 62 Specification 3.0 - Protection AS-i side, 4 A	56473
EtherCAT			Art-No.
	<b>Gateway-Doublemaster</b> AS-Interface/EtherCAT No. of slaves AS-Interface data decoupling integrated Serial interface/diagnostic	Protection IP20 max. 2 × 62 Specification 3.0 RJ45/Ethernet Protection AS-i side, 4 A	56458



## MASI CONTROL CABINET

MASI00			Art-No.
	<b>Digital inputs/outputs</b> DI4/DO4 - 0.2 A Sensor supply US Switching current per output Profile (IO/ID/ID2 code) Address range Standard-Slave	Protection IP00 max. 200 mA (AS-Interface) max. 30 mA S-7.FF 1...31 via plug terminals Specification 3.0	<b>55700</b>
	DI4/DO4 - 0.2 A (AB) Sensor supply US Switching current per output Profile (IO/ID/ID2 code) Address range AB-Slave	Protection IP00 max. 200 mA (AS-Interface) max. 30 mA S-7.A.7 1...62 (1...31 A or B) via plug-in terminal Specification 3.0	<b>55701</b>
	<b>Digital inputs/outputs</b> DI4/DO4 - 0.2 A Sensor supply US Switching current per output Connection cable for pin cable lug Profile (IO/ID/ID2 code) Address range Standard-Slave	Protection IP00 max. 200 mA (AS-Interface) max. 30 mA 250 mm S-7.FF 1...31 via plug terminals Specification 3.0	<b>556625</b>
	DI4/DO4 - 0.2 A (AB) Sensor supply US Switching current per output Connection cable for pin cable lug Profile (IO/ID/ID2 code) Address range AB-Slave	Protection IP00 max. 200 mA (AS-Interface) max. 30 mA 250 mm S-7.A.7 1...62 (1...31 A or B) via plug-in terminal Specification 3.0	<b>556639</b>
	<b>Connection cable MASI00</b> with open ended wires	1 000 mm	<b>556510</b>
	<b>Connection cable MASI00</b> with cable fork	150 mm	<b>556511</b>

MASI20			Art-No.
	<p><b>Digital inputs/outputs</b>                      DI4 - 0.2 A DO4 - 0.5 A (AB) K3                      Sensor supply US                      Switching current per output                      Profile (IO/ID/ID2 code)                      Address range                      AB-Slave                      passive safe outputs</p>	<p>Protection IP20                      from AS-Interface or 24 V DC (EN 61131-2)                      max. 0.5 A                      S-7.A.7                      1...62 (1...31 A or B)                      Specification 3.0                      can be switched off via safety relays</p>	<p>56440</p>
	<p><b>Digital inputs/outputs</b>                      DI4 - 0.15 A DO4 - 2 A K3                      Sensor supply US                      Switching current per output                      Profile (IO/ID/ID2 code)                      Address range                      Standard-Slave                      passive safe outputs</p>	<p>Protection IP20                      from AS-Interface or 24 V DC (EN 61131-2)                      max. 2 A                      S-7.0.E                      1...31                      Specification 3.0                      can be switched off via safety relays</p>	<p>56475</p>
	<p>DI4 - 0.15 A DO4 - 2 A (AB) K3                      Sensor supply US                      Switching current per output                      Profile (IO/ID/ID2 code)                      Address range                      AB-Slave                      passive safe outputs</p>	<p>Protection IP20                      from AS-Interface or 24 V DC (EN 61131-2)                      max. 2 A                      S-7.A.7                      1...62 (1...31 A or B)                      Specification 3.0                      can be switched off via safety relays</p>	<p>56476</p>
	<p><b>Digital inputs/relay outputs</b>                      DI4 - 0.15 A DO4R - 2 A                      Sensor supply US                      Switching current per output                      Relay outputs                      Profile (IO/ID/ID2 code)                      Address range                      Standard-Slave</p>	<p>Protection IP20                      from AS-Interface or 24 V DC (EN 61131-2)                      2 A                      -                      S-7.0.E                      1...31                      Specification 3.0</p>	<p>56477</p>
	<p>DI4 - 0.15 A DO4R - 2 A (AB)                      Sensor supply US                      Switching current per output                      Relay outputs                      Profile (IO/ID/ID2 code)                      Address range                      AB-Slave</p>	<p>Protection IP20                      from AS-Interface or 24 V DC (EN 61131-2)                      2 A                      -                      S-7.A.7                      1...62 (1...31 A or B)                      Specification 3.0</p>	<p>56478</p>

## MASI CONTROL CABINET

Power Supply Units			Art-No.
	<p><b>Switch mode power supplies</b>            Single-phase, primary switched            Input voltage            Output voltage            Efficiency            Output current</p>	<p>Protection IP20            95..265 V AC            30.5 V DC (SELV), ±2%            83% (110 V AC); 85% (240 V AC)            max. 4.0 A (+40 °C); 3.4 A (+55 °C)</p>	<p><b>85381</b></p>
	<p><b>Switch mode power supplies</b>            Single-phase, primary switched            Input voltage            Output voltage            with EFD (earth fault detection)            Efficiency            Output current</p>	<p>Protection IP20            95..265 V AC            30.5 V DC (SELV), ±2%            -            83% (110 V AC); 85% (240 V AC)            max. 4.0 A (+40 °C); 3.4 A (+55 °C)</p>	<p><b>85382</b></p>
	<p><b>Switch mode power supplies</b>            3-phase, primary switched            Input voltage            Output voltage            Efficiency            Output current</p>	<p>Protection IP20            3×324..572 V AC/2×340..572 V AC/450..745 V DC            30.5 V DC (SELV), ±1%; 30..32 V adjustable            92.5% (3 × 400 V AC); 91.8% (3 × 480 V AC)            4.8 A (45 °C); 4.0 A (60 °C); 2.9 A (70 °C)</p>	<p><b>85383</b></p>



# MASI FOR FIELD INSTALLATION

- Flexible use
- Quick installation
- Efficient technology

## APPLICATION VARIETY – FOR EFFICIENT AND DECENTRALIZED INSTALLATION

MASI, the AS-Interface product series by Murrelektronik, is the simple solution for cost-efficient integration of I/O signals from machine tools or storage and logistics systems to superordinate control systems. MASI allows the user to build highly flexible I/O systems without being tied to rigid topologies.

Who wants to wire control cabinets or set up complex bus solutions when this can be also done in a more simple, flexible, efficient, and robust way? The MASI I/O system allows you to install all the components at the place where they are needed. This allows a clearly arranged wiring and reduces the installation effort to a minimum.



### ➤ MASI

I/O modules, accessories and accompanying information material regarding MASI can be found in the **online shop:**

➤ [shop.murrelektronik.com](http://shop.murrelektronik.com)

## MASI65



### Valve plug (form A)

- M12
- Degree of protection IP67

Page 4.9.1

## MASI67



### I/O modules

- Digital inputs
- Digital inputs/outputs
- Degree of protection IP67

Page 4.9.1

## MASI68



### I/O modules

- Digital inputs
- Digital inputs/outputs
- Analog outputs
- Analog inputs
- Degree of protection IP67

Page 4.9.3

# MASI FIELD INSTALLATION

MASI65			Art-No.
	<b>Digital inputs/outputs</b> DO1 - 2A, DO1 - 2 A, DI2 Sensor supply US Switching current per output Valve Plug (Form A), M12, M12 Profile (IO/ID/ID2 code) Address range Standard-Slave	Protection IP67 max. 200 mA (AS-Interface) max. 2 A - S-3.FE 1...31 Specification 2.1	55680
	<b>Digital outputs</b> DO1 - 2A, DO1 - 2 A Switching current per output Standard-Slave Valve Plug (Form A), M12 Profile (IO/ID/ID2 code) Address range	Protection IP67 max. 2 A Specification 2.1 - S-3.FE 1...31	55681
	DO1 - 2A Switching current per output Standard-Slave Valve plug (form A) Profile (IO/ID/ID2 code) Address range	Protection IP67 max. 2 A Specification 2.1 - S-3.FE 1...31	55682
	<b>Digital inputs/outputs</b> DO1 - 2A, DO1 - 2 A, DI2 Sensor supply US Switching current per output Ventilstecker (Form B), M12, M12 Profile (IO/ID/ID2 code) Address range Standard-Slave	Protection IP67 max. 200 mA (AS-Interface) max. 2 A - S-3.FE 1...31 Specification 2.1	556613
	<b>Digital outputs</b> DO1 - 2A Switching current per output Standard-Slave Valve plug (form B) Profile (IO/ID/ID2 code) Address range	Protection IP67 max. 2 A Specification 2.1 - S-3.FE 1...31	556614
MASI67			Art-No.
	<b>Digital inputs</b> DI4 - 0.2 A (AB) 4xM8 Sensor supply US AB-Slave Profile (IO/ID/ID2 code) Address range	Protection IP67 max. 170 mA (AS-Interface) Specification 3.0 S-0.A.0 1...62 (1...31 A or B)	56405

## MASI FIELD INSTALLATION

MASI67			Art-No.
	<p><b>Digital inputs</b>            DI8 - 0.24 A (AB) 8×M8            Sensor supply US            AB-Slave            Profile (IO/ID/ID2 code)            Address range</p>	<p>Protection IP67            max. 180 mA (AS-Interface)            Specification 3.0            2 × S-0.A.0            1...62 (2 × 1...31 A or B)</p>	<p><b>56406</b></p>
	<p><b>Digital inputs/outputs</b>            DI4 - 0.2 A DO4 - 0.5 A 8×M8            Sensor supply US            Standard-Slave            Profile (IO/ID/ID2 code)            Address range</p>	<p>Protection IP67            max. 180 mA (AS-Interface)            Specification 3.0            S-7.0.E            1...31</p>	<p><b>56408</b></p>
	<p><b>Digital inputs</b>            DI4 - 0.2 A (AB) 4×M12            Sensor supply US            AB-Slave            Configuration            Profile (IO/ID/ID2 code)            Address range</p>	<p>Protection IP67            max. 170 mA (AS-Interface)            Specification 3.0            PIN 2 = 4            S-0.A.0            1...62 (1...31 A or B)</p>	<p><b>56400</b></p>
	<p>DI4 - 0.2 A (AB) 4×M12            Sensor supply US            AB-Slave            Configuration            Profile (IO/ID/ID2 code)            Address range</p>	<p>Protection IP67            max. 170 mA (AS-Interface)            Specification 3.0            Y-wiring            S-0.A.2            1...62 (1...31 A or B)</p>	<p><b>56413</b></p>
	<p>DI8 - 0.24 A (AB) 4×M12            Sensor supply US            AB-Slave            Configuration            Profile (IO/ID/ID2 code)            Address range</p>	<p>Protection IP67            max. 180 mA (AS-Interface)            Specification 3.0            PIN 2 + 4            2 × S-0.A.2            1...62 (2 × 1...31 A or B)</p>	<p><b>56401</b></p>
	<p><b>Digital inputs/outputs</b>            DI4 - 1.6 A DO4 - 2 A 4×M12            Sensor supply US            Switching current per output            Configuration            Profile (IO/ID/ID2 code)            Address range            Standard-Slave</p>	<p>Protection IP67            max. 1.6 A external            max. 2 A            PIN 2 + 4            S-7.FE            1...31            Specification 3.0</p>	<p><b>56404</b></p>
	<p>DI4 - 0.2 A DO4 - 1.6 A (C) 4×M12 (AB) K3            Sensor supply US            Switching current per output            Configuration            Profile (IO/ID/ID2 code)            Address range            AB-Slave            passive safe outputs</p>	<p>Protection IP67            max. 200 mA (AS-Interface)            max. 1.6 A            PIN 2 + 4            S-7.A.7            1...62 (1...31 A or B)            Specification 3.0            can be switched off via safety relays</p>	<p><b>56414</b></p>

MASI67			Art-No.
	<p><b>Digital inputs/outputs</b>                      DI8 - 0.34 A DO8 - 1.6 A (AB) 8×M12 (K3)                      Sensor supply US                      Switching current per output                      Configuration                      Profile (IO/ID/ID2 code)                      Address range                      AB-Slave                      passive safe outputs</p>	<p>Protection IP67                      max. 340 mA (AS-Interface)                      max. 1.6 A                      PIN 2 + 4                      2 × S-7.A.7                      1...62 (2 × 1...31 A or B)                      Specification 3.0                      can be switched off via safety relays</p>	<p>56415</p>
	<p><b>Digital outputs</b>                      DO8 - 1.6 A (AB) 8×M12 (K3) Safety                      Switching current per output                      passive safe outputs                      Configuration                      Profile (IO/ID/ID2 code)                      Address range                      AB-Slave</p>	<p>Protection IP67                      max. 1.6 A                      can be switched off via safety relays                      Y-wiring                      S-7.A.7                      1...62 (1...31 A or B)                      Specification 3.0</p>	<p>56445</p>
MASI68			Art-No.
	<p><b>Digital inputs</b>                      DI4 - 0.18 A (C) 4×M8 (AB)                      Sensor supply US                      AB-Slave                      Compact module                      Profile (IO/ID/ID2 code)                      Address range</p>	<p>Protection IP68                      max. 180 mA (AS-Interface)                      Specification 3.0                      -                      S-0.A.2                      1...62 (1...31 A or B)</p>	<p>56434</p>
	<p>DI4 - 0.18 A (C) 4×M8                      Sensor supply US                      Standard-Slave                      Compact module                      Profile (IO/ID/ID2 code)                      Address range</p>	<p>Protection IP68                      max. 180 mA (AS-Interface)                      Specification 3.0                      -                      S-0.0.0                      1...31</p>	<p>56435</p>
	<p><b>Digital inputs/outputs</b>                      DI2 - 0.1 A DO2 - 0.5 A (C) 4×M8 (AB)                      Sensor supply US                      Switching current per output                      Compact module                      Profile (IO/ID/ID2 code)                      Address range                      AB-Slave</p>	<p>Protection IP68                      max. 100 mA (AS-Interface)                      max. 0.5 A                      -                      S-7.A.E                      1...62 (1...31 A or B)                      Specification 3.0</p>	<p>56446</p>

## MASI FIELD INSTALLATION

MASI68			Art-No.
	<b>Digital inputs</b> DI8 - 0.2 A (C) 8×M8 (AB) Sensor supply US AB-Slave Compact module Profile (IO/ID/ID2 code) Address range	Protection IP68 max. 200 mA (AS-Interface) Specification 3.0 - 2 × S-0.A.0 1...62 (2 × 1...31 A or B)	<b>56420</b>
	DI8 - 0.2 A (C) 8×M8 (AB) Sensor supply US AB-Slave Compact module Profile (IO/ID/ID2 code) Address range	Protection IP68 max. 200 mA (AS-Interface) Specification 3.0 Slave 1: 1 A; Slave2: 2 A 2 × S-0.A.0 1...62 (1...31 A or B)	<b>56421</b>
	<b>Digital inputs/outputs</b> DI4 - 0.19 A DO3 - 0.5 A (C) 7×M8 (AB) Sensor supply US Switching current per output Compact module Profile (IO/ID/ID2 code) Address range AB-Slave	Protection IP68 max. 190 mA (AS-Interface) max. 0.5 A - S-7.A.0 1...62 (1...31 A or B) Specification 2.1	<b>56418</b>
	DI4 - 0.19 A DO4 - 0.5 A (C) 8×M8 Sensor supply US Switching current per output Compact module Profile (IO/ID/ID2 code) Address range Standard-Slave	Protection IP68 max. 190 mA (AS-Interface) max. 0.5 A - S-7.0.0 1...31 Specification 3.0	<b>56419</b>
	DI4 - 0.2 A DO4 - 0.5 A (C) 8×M8 (AB) Sensor supply US Switching current per output Compact module Profile (IO/ID/ID2 code) Address range AB-Slave	Protection IP68 max. 190 mA (AS-Interface) max. 0.5 A - S-7.A.7 1...62 (1...31 A or B) Specification 3.0	<b>56462</b>
	<b>Digital inputs</b> DI8 - 0.19 A (E) 8×M8 (AB) Sensor supply US AB-Slave Expansion module Profile (IO/ID/ID2 code) Address range	Protection IP68 max. 190 mA (AS-Interface) Specification 3.0 - 2 × S-0.A.E 1...62 (1...31 A or B)	<b>56436</b>



MASI68			Art-No.
	<p><b>Digital inputs</b>                      DI4 - 0.19 A (C) 4×M12 (AB) (Y)                      Sensor supply US                      AB-Slave                      Compact module                      Profile (IO/ID/ID2 code)                      Address range</p>	<p>Protection IP68                      max. 190 mA (AS-Interface)                      Specification 3.0                      Y-wiring                      S-0.A.2                      1...62 (1...31 A or B)</p>	<p><b>56421</b></p>
	<p>DI8 - 0.19 A (C) 4×M12 (AB)                      Sensor supply US                      AB-Slave                      Compact module                      Profile (IO/ID/ID2 code)                      Address range</p>	<p>Protection IP68                      max. 190 mA (AS-Interface)                      Specification 3.0                      PIN 2 + 4                      2 × S-0.A.2                      1...62 (2 × 1...31 A or B)</p>	<p><b>56424</b></p>
	<p><b>Digital inputs</b>                      DI4 - 0.2 A (E) 4×M12 (AB) (Y)                      Sensor supply US                      AB-Slave                      Expansion module                      Profile (IO/ID/ID2 code)                      Address range</p>	<p>Protection IP68                      max. 200 mA (AS-Interface)                      Specification 3.0                      Y-wiring                      S-0.A.2                      1...62 (1...31 A or B)</p>	<p><b>56425</b></p>
	<p>DI4 - 0.19 A (E) 4×M12 (AB) (Y) AUX                      Sensor supply US                      AB-Slave                      Expansion module                      Profile (IO/ID/ID2 code)                      Address range</p>	<p>Protection IP68                      max. 190 mA (AUX Power)                      Specification 3.0                      Y-wiring                      S-0.A.2                      1...62 (1...31 A or B)</p>	<p><b>56443</b></p>
	<p>DI8 - 0.19 A (E) 4×M12 (AB)                      Sensor supply US                      AB-Slave                      Expansion module                      Profile (IO/ID/ID2 code)                      Address range</p>	<p>Protection IP68                      max. 190 mA (AS-Interface)                      Specification 3.0                      PIN 2 + 4                      2 × S-0.A.2                      1...62 (2 × 1...31 A or B)</p>	<p><b>56426</b></p>
	<p>DI8 - 0.19 A (E) 4×M12 (AB) AUX                      Sensor supply US                      AB-Slave                      Expansion module                      Profile (IO/ID/ID2 code)                      Address range</p>	<p>Protection IP68                      max. 190 mA (AUX Power)                      Specification 3.0                      PIN 2 + 4                      2 × S-0.A.2                      1...62 (2 × 1...31 A or B)</p>	<p><b>56444</b></p>
	<p><b>Digital inputs/outputs</b>                      DI4 - 0.19 A DO4 - 1 A (E) 4×M12 (AB)                      Sensor supply US                      Switching current per output                      Expansion module                      Profile (IO/ID/ID2 code)                      Address range                      AB-Slave</p>	<p>Protection IP68                      max. 190 mA (AS-Interface)                      max. 1 A                      PIN 2 + 4                      S-7.A.7                      1...62 (1...31 A or B)                      Specification 3.0</p>	<p><b>56439</b></p>

## MASI FIELD INSTALLATION

MASI68			Art-No.
	<p><b>Digital outputs</b></p> <p>DO8 - 0.5 A (AB) 4×M12 (K3)</p> <p>Switching current per output</p> <p>passive safe outputs</p> <p>Expansion module</p> <p>Profile (IO/ID/ID2 code)</p> <p>Address range</p> <p>AB-Slave</p>	<p>Protection IP68</p> <p>max. 0.5 A</p> <p>can be switched off via safety relays</p> <p>PIN 2 + 4</p> <p>S-7.A.7</p> <p>1...62 (1...31 A or B)</p> <p>Specification 3.0</p>	56447
	<p><b>Digital inputs/outputs</b></p> <p>DI4 - 0.19 A DO4 - 2 A (C) 8×M12 (Y)</p> <p>Sensor supply US</p> <p>Switching current per output</p> <p>Compact module</p> <p>Profile (IO/ID/ID2 code)</p> <p>Address range</p> <p>Standard-Slave</p>	<p>Protection IP68</p> <p>max. 190 mA (AS-Interface)</p> <p>max. 2 A</p> <p>Y-wiring</p> <p>S-7.FE</p> <p>1...31</p> <p>Specification 3.0</p>	56422
	<p>DI4 - 0.19 A DO4 - 2 A (C) 8×M12</p> <p>Sensor supply US</p> <p>Switching current per output</p> <p>Compact module</p> <p>Profile (IO/ID/ID2 code)</p> <p>Address range</p> <p>Standard-Slave</p>	<p>Protection IP68</p> <p>max. 190 mA (AS-Interface)</p> <p>max. 2 A</p> <p>PIN 4</p> <p>S-7.0.7</p> <p>1...31</p> <p>Specification 3.0</p>	56438
	<p>DI4 - 0.2 A DO4 - 1.6 A (C) 8×M12 (AB) (Y) (K3)</p> <p>Sensor supply US</p> <p>Switching current per output</p> <p>Compact module</p> <p>Profile (IO/ID/ID2 code)</p> <p>Address range</p> <p>AB-Slave</p> <p>passive safe outputs</p>	<p>Protection IP68</p> <p>max. 200 mA (AS-Interface)</p> <p>max. 1.6 A</p> <p>Y-wiring</p> <p>S-7.A.7</p> <p>1...62 (1...31 A or B)</p> <p>Specification 3.0</p> <p>can be switched off via safety relays</p>	56423
	<p><b>Digital inputs/outputs</b></p> <p>DI4 - 0.2 A DO4 - 2 A (E) 8×M12 (Y)</p> <p>Sensor supply US</p> <p>Switching current per output</p> <p>Expansion module</p> <p>Profile (IO/ID/ID2 code)</p> <p>Address range</p> <p>Standard-Slave</p>	<p>Protection IP68</p> <p>max. 200 mA (AS-Interface)</p> <p>max. 2 A</p> <p>Y-wiring</p> <p>S-7.FE</p> <p>1...31</p> <p>Specification 3.0</p>	56427
	<p><b>Digital inputs/outputs</b></p> <p>DI4 - 0.2 A DO4 - 1.6 A (E) 8×M12 (AB) (Y) (K3)</p> <p>Sensor supply US</p> <p>Switching current per output</p> <p>Expansion module</p> <p>Profile (IO/ID/ID2 code)</p> <p>Address range</p> <p>AB-Slave</p> <p>passive safe outputs</p>	<p>Protection IP68</p> <p>max. 200 mA (AS-Interface)</p> <p>max. 1.6 A</p> <p>Y-wiring</p> <p>S-7.A.7</p> <p>1...62 (1...31 A or B)</p> <p>Specification 3.0</p> <p>can be switched off via safety relays</p>	56428

MASI68			Art-No.
	<p><b>Analog inputs</b>                      AI4 - (E) RTD                      Measuring current                      Standard-Slave                      Expansion module                      Profile (IO/ID/ID2 code)                      Address range</p>	<p>Protection IP68                      Pt100 - 1.25 mA                      Specification 3.0                      -                      S-7.3.E                      1...31</p>	<p>56442</p>
	<p>AI4 - (E) 4×M12 (UI)                      Input range (current)                      Input range (voltage)                      Expansion module                      Profile (IO/ID/ID2 code)                      Address range                      Standard-Slave</p>	<p>Protection IP68                      -22...22 mA                      -10...+10 V                      -                      S-7.3.E                      1...31                      Specification 3.0</p>	<p>56448</p>
	<p><b>Analog outputs</b>                      AO2 - (E) 2×M12 (UI)                      Output current                      Output voltage                      Expansion module                      Profile (IO/ID/ID2 code)                      Address range                      Standard-Slave</p>	<p>Protection IP68                      0...22 mA                      -10...+10 V                      -                      S-7.3.5                      1...31                      Specification 3.0</p>	<p>56474</p>

# MASI INSTALLATION TECHNOLOGY

- Versatile
- Leak-proof for industrial use
- Simplest installation

## AS-INTERFACE SYSTEM

In connection with the installation technology, the AS-Interface system from Murrelektronik provides consistent solutions from the operating panel through the control cabinet to the field - from IP00 to IP68.

Due to the application-oriented optimization of the modules, a safe installation and extension of the system can be realized very easily.

- **Easy** – Connection using the cable penetration technology, plug-in connectors or M12
- **Consistent** – products adapted to the fields of application from IP00 to IP68
- **Up-to-date** – latest technology according to the AS-interface specification 3.0



### ➤ MASI

I/O modules, accessories and accompanying information material regarding MASI can be found in the **online shop**:

➤ [shop.murrelektronik.com](http://shop.murrelektronik.com)

## MASI20/67/68



- Distributor
- Converter
- Adapter

Page 4.10.1

## System/Torque wrenches



- Programming device
- Z-plug
- T-coupler
- Mounting plates

Page 4.10.3



- Torque wrench M8
- Torque wrench M12
- Torque wrench 7/8"

Page 4.10.3

## Cables



- Profile cables**
- Coding elements
  - Adapter, terminals

Page 4.10.4



- Round plug connector**
- T-coupler
  - DIN-rail adapter
  - Connecting cables

Page 4.10.6











MASI20			Art-No.
	<b>Bus or Power distributor</b> 2 AS-Interface + 3 power ports potentially separated	5 plug terminals included	55575
	3 AS-Interface + 2 power ports potentially separated	5 plug terminals included	55606
	<b>Bus or Power distributor</b> 1 × 3 AS-Interface + 2 × 1 power ports 5 ports, universal potentially separated	5 plug terminals included	55605
	1 × 5 AS-Interface/power ports 5 ports, universal not potentially separated	5 plug terminals included	55611
	<b>Bus or Power distributor</b> 1 × 3 AS-Interface + 2 × 1 power ports 5 ports, universal potentially separated	without plug terminals	55607
	<b>Plug terminal</b> for bus or power distributor	AS-Interface profile cable	55604
MASI67			Art-No.
	<b>MASI67 connection</b> 2 × on 2 × profile cable Total current: max. 8 A		55033
	1 × on 3 × profile cable Total current: max. 8 A		55034
	<b>MASI67 converter</b> 2 × profile cable to 7/8" (female) Total current: max. 8 A	5-pole	55035
	<b>MASI67 converter</b> 2 × profile cable to 7/8" (male) Total current: max. 8 A	5-pole	55036
	<b>MASI67 converter</b> 2 × profile cable to M12 (female) Total current: max. 4 A	M12, 4-pole, A-coded	55037

## MASI INSTALLATION TECHNOLOGY

MASI67		Art-No.
	<b>MASI67 converter</b> 2 × profile cable to M12 (male) Total current: max. 4 A	M12, 4-pole, A-coded  55038
	<b>AS-Interface distributor</b> from profile to profile cable Operating current: max. 3 A	55749
	<b>AS-Interface breakout</b> from profile cable to M12 Operating current: max. 2 A	M12, 2-pole, A-coded  55741
MASI67/68		Art-No.
	<b>MASI67 passive distribution box</b> 2 × profile cable to 4 × M12 (female) Current (M12): max. 4 A Total current: max. 8 A Ext. supply: 1 × aux power	M12, 4-pole, A-coded  56412
	2 × profile cable to 4 × M12 (female) Current (M12): max. 4 A Total current: max. 2 × 8 A Ext. supply: 2 × separately aux power	M12, 4-pole, A-coded  56416
MASI68		Art-No.
	<b>MASI68 passive distribution box</b> 1×7/8 AUX + 1×M12 AS-Interface to 3×M12 (female) Current (M12): max. 4 A Total current: max. 2 × 8 A	M12, 4-pole, A-coded 2 separate circuits  56454
	<b>T-coupler (SlimLine) M12 - M12</b> Male straight - female straight Parallel circuit	5-pole  7000-41151-0000000
	<b>T-coupler M12 - M12</b> Male straight - female straight Parallel circuit	5-pole  7000-41141-0000000
	<b>Holding plate</b> for T-couplers M12 (SlimLine)	without mounting set
	for T-couplers M12 (SlimLine)	with mounting set

System			Art-No.
	<b>Programming device</b> AS-Interface programming device	AS-Interface addressing cable	55696
	<b>Addressing cable</b> Spare cable	for AS-Interface programming device	55727
	<b>MASI Z-Plug</b> Passive bus terminator		55779
	<b>T-coupler (SlimLine) M12 - M12</b> Male straight - female straight Distribution function (NO)	5-pole - 4-pole	7000-41131-0000000
	<b>T-coupler M12 - M12</b> Male straight - female straight Distribution function (NO)	5-pole - 4-pole	7000-41121-0000000
	<b>Holding plate</b> for T-couplers M12 (SlimLine) for T-couplers M12 (SlimLine)	without mounting set	7000-99061-0000000
		with mounting set	7000-99062-0000000
<b>Torque wrench</b>			<b>Art-No.</b>
	<b>Torque wrench set</b> M12 (0.6 Nm, SW13)	M12 data connector molded (standard)	7000-99102-0000000
	<b>Torque wrench</b> M12 (0.6 Nm, SW13) M12 (0.6 Nm, SW14)	M12 data connector molded (standard)	7000-99109-0000000
		M12 data connector moulded (Xtreme)	7000-99108-0000000
	<b>Torque wrench</b> M12 (0.6 Nm, SW17)	M12 field-wireable (IDC terminal)	7000-99094-0000000
	<b>Torque wrench</b> M12 (0.6 Nm, SW18)	M12 field-wireable via (screw terminals)	7000-99103-0000000
	<b>Torque wrench set</b> M8 (0.4 Nm, SW9)	M8 data connectors	7000-99101-0000000

## MASI INSTALLATION TECHNOLOGY

Torque wrench			Art-No.
	<b>Torque wrench</b> M8 (0.4 Nm, SW9)	M8 data connectors	7000-99091-000000
	<b>Torque wrench set</b> 7/8" (1.5 Nm, SW22)	7/8" data connenctor moulded (IDC terminal)	7000-99104-000000
	<b>Torque wrench</b> 7/8" (1.5 Nm, SW22) 7/8" (1.5 Nm, SW24)	7/8" data connenctor moulded (IDC terminal) 7700-XXXXX - 7/8" data connenctor moulded (screw terminals)	7000-99096-000000 7000-99097-000000
For profile cable			Art-No.
	<b>Coding element - short</b> for MASI67 AS-i	Quantity: 2 pcs.	55059
	<b>Coding element - long</b> for MASI67 AUX	Quantity: 2 pcs.	55060
	<b>Mounting bracket</b> for AS-Interface profile cable	Quantity: 50 pcs.	55742
	<b>Adapter</b> from profile cable to M16		56453
	<b>Plug terminal</b> for bus or power distributor	AS-Interface profile cable	55604
	<b>AS-Interface distributor</b> from profile to profile cable Operating current: max. 3 A		55749
	<b>AS-Interface breakout</b> from profile cable to M12 Operating current: max. 2 A	M12, 2-pole, A-coded	55741



For profile cable			Art-No.
	<b>Middle gasket</b> for profile cable	Quantity: 2 pcs.	55062
	<b>End gasket</b> for Profile cable left/right	Quantity: 2 pieces right + 2 pieces left	55061
	<b>End gasket</b> for profile cable right	Quantity: 100 pcs.	56432
	<b>End gasket</b> for Profile cable left	Quantity: 100 pcs.	56433
	<b>End gasket</b> for Profile cable left/right	Quantity: 5 pcs. right + 5 pcs. left	55746
	<b>Bulk cable</b> Profile cable yellow, 2 × 1.5 mm <sup>2</sup> PUR (UL/CSA), C-tracks	1 m	55743
	<b>Bulk cable</b> Profile cable yellow, 2 × 1.5 mm <sup>2</sup> PUR (UL/CSA), C-tracks Profile cable yellow, 2 × 2.5 mm <sup>2</sup> PUR (UL/CSA), C-tracks	Cable ring: 100 m Other versions on request.	7000-C9901-1660000 7000-C9901-1780000
	<b>Bulk cable</b> Profile cable black, 2 × 1.5 mm <sup>2</sup> PUR (UL/CSA), C-tracks	1 m	55744
	<b>Bulk cable</b> Profile cable black, 2 × 1.5 mm <sup>2</sup> PUR (UL/CSA), C-tracks Profile cable black, 2 × 2.5 mm <sup>2</sup> PUR (UL/CSA), C-tracks	Cable ring: 100 m Other versions on request.	7000-C9901-7840000 7000-C9901-7790000

## MASI INSTALLATION TECHNOLOGY

Round cable MASI68			Art-No.
	<b>T-coupler M12 – M12</b> Female straight - male/male straight A-coded, 4-pole	MASI68 additional actuator power supply	7060-42701-000000
	Female straight - male/male straight Distribution function (NO) MASI68 additional actuator power supply MVK Metall Safety	4-pole	7060-42703-000000
	<b>DIN-rail adapter</b> for extension modules	30 mm	56963
		<b>DIN-rail adapter</b> for extension modules	50 mm
	<b>Cable drum (100 m)</b> 2 × 1.5 mm <sup>2</sup> , gray Suitable for C-tracks	AS-Interface, MASI68	7000-C0201-588000
Round plug connectors MASI68			Art-No.
	<b>Connection cable</b> Male straight - female straight 2 × 1.5 mm <sup>2</sup> , gray PUR (UL/CSA) 1.0 m	M12 - M12 2-pole Suitable for C-tracks Other versions on request.	7060-40005-5880100
	Male straight - female straight 4 × 0.75 mm <sup>2</sup> , gray PUR (UL/CSA) 1.0 m	M12 - M12 4-pole Suitable for C-tracks Other versions on request.	7060-40021-8620100
	<b>Connection cable</b> Male 90° - female 90° 2 × 1.5 mm <sup>2</sup> , gray PUR (UL/CSA) 1.0 m	M12 - M12 2-pole Suitable for C-tracks Other versions on request.	7060-40245-5880100
	Male 90° - female 90° 4 × 0.75 mm <sup>2</sup> , gray PUR (UL/CSA) 1.0 m	M12 - M12 4-pole Suitable for C-tracks Other versions on request.	7060-40261-8620100

Round plug connectors MASI68			Art-No.
	<b>Connection cable</b> Male straight - female straight 2 × 1.0 mm <sup>2</sup> , gray PUR (UL/CSA) 1.0 m	M12 - M12 2-pole, shielded Suitable for C-tracks Other versions on request.	7060-40485-5420100
	Male straight - female straight 2 × 0.75 mm <sup>2</sup> + 2 × 0.75 mm <sup>2</sup> , gray PUR (UL/CSA) 1.0 m	M12 - M12 4-pole, shielded Suitable for C-tracks Other versions on request.	7060-40505-4940100
	<b>With open ended wires</b> Female straight 4 × 0.75 mm <sup>2</sup> , gray PUR (UL/CSA) 1.0 m	M12 4-pole Suitable for C-tracks Other versions on request.	7060-12221-8620100
Labeling accessories			Art-No.
	<b>Label plates</b> 20 × 8 mm	(20 pieces per plate)	55318
Blind plug/caps			Art-No.
	<b>Screw plug M12 × 1 mm</b> Plastic, hex with gasket	Quantity: 4 pcs.	55468
	Plastic, hex with gasket	Quantity: 100 pcs.	56455
	Plastic, hex without gasket	Quantity: 4 pcs.	56952
	Plastic, hex without gasket	Quantity: 10 pcs.	58627
	<b>Screw plug M8 × 1 mm (for female)</b> Plastic, hex without gasket	Quantity: 10 pcs.	3858627



# M8 DISTRIBUTION SYSTEMS EXACT8

- Saves space
- Versatile
- Application oriented

## EXACT8 – THE NEW GENERATION OF MURRELEKTRONIK'S M8 DISTRIBUTION BOXES

- Small dimensions (30 mm width)
- PUR/PVC cable for flexible and fixed assembly
- High-quality, halogen-free PUR cable suitable for C-tracks, UL/CSA approved
- Standard or side mounting for limited space
- Quick and easy replacement of connection cables

### For Sensors and Actuators – Molded Homerun Cables or Connection Caps

 <p><b>Exact8</b></p> <ul style="list-style-type: none"><li>• 4-, 6-, 8-, 10-way</li><li>• PUR or PUR/PVC homerun cable</li></ul> <p><i>Page 4.11.1</i></p>	 <p><b>Exact8 basic modules</b></p> <ul style="list-style-type: none"><li>• 4-, 6-, 8-, 10-way</li></ul> <p><i>Page 4.11.5</i></p>
 <p><b>Exact8 connection caps</b></p> <ul style="list-style-type: none"><li>• Pre-wired</li><li>• PUR or PUR/PVC homerun cable</li></ul> <p><i>Page 4.11.8</i></p>	 <p><b>Exact8 set</b></p> <ul style="list-style-type: none"><li>• 4-, 6-, 8-, 10-way</li><li>• Field-wireable</li></ul> <p><i>Page 4.11.11</i></p>

### For Sensors – with M12 Connection

 <p><b>Exact8</b></p> <ul style="list-style-type: none"><li>• 4-, 6-, 8-, 10-way</li><li>• With 8- or 12-pole M12 connection</li></ul> <p><i>Page 4.11.12</i></p>
---

# M8 DISTRIBUTION SYSTEMS

- For sensors and actuators
- with molded homerun cable
- Inline face or side mounting



**Exact8**  
4-way



**Exact8**  
6-way



**Exact8**  
8-way



**Exact8**  
10-way



1 Form	84010	86010	88010	80010
Type	PNP, 3-pole	PNP, 3-pole	PNP, 3-pole	PNP, 3-pole
Contact layout	M8-Females 3-pole 			
2 Cable Type	Jacket Color – No./diameter of wires			
	gray	gray	gray	gray
PUR/PVC	337 – 4 × 0.34 + 2 × 0.75 mm <sup>2</sup>	350 – 6 × 0.34 + 2 × 0.75 mm <sup>2</sup>	357 – 8 × 0.34 + 2 × 0.75 mm <sup>2</sup>	385 – 10 × 0.34 + 2 × 0.75 mm <sup>2</sup>
PUR (UL/CSA), robots/C-tracks	334 – 4 × 0.34 + 2 × 0.75 mm <sup>2</sup>	356 – 6 × 0.34 + 2 × 0.75 mm <sup>2</sup>	359 – 8 × 0.34 + 2 × 0.75 mm <sup>2</sup>	384 – 10 × 0.34 + 2 × 0.75 mm <sup>2</sup>
3 Cable Length				
3.0 m	0300			
5.0 m	0500			
10.0 m	1000			
15.0 m	1500			
Technical Data				
Operating voltage	24 V DC			
Total current	max. 8 A			
Protection	IP65/IP67			
Temperature range	-20...+80 °C, depending on cable quality			
Contact Layout				
LED display	LED (green): Power / LED (yellow): (S1)			
PIN 1	(+)			
PIN 3	(-)			
PIN 4	(NO)/(S1)			
Article No.				
The composition of your article number is explained on page 3.1.i	<div style="display: flex; justify-content: space-around; align-items: center;"> <span style="border: 1px solid black; padding: 2px 5px;">8</span> <span style="border: 1px solid black; padding: 2px 5px;">0</span> <span style="border: 1px solid black; padding: 2px 5px;">0</span> <span style="border: 1px solid black; padding: 2px 5px;">0</span> <span style="font-size: 2em;">-</span> <span style="border: 1px solid black; padding: 2px 5px;">-</span> <span style="font-size: 2em;">-</span> <span style="border: 1px solid black; padding: 2px 5px;">-</span> <span style="font-size: 2em;">-</span> <span style="border: 1px solid black; padding: 2px 5px;">-</span> </div>			
	<b>1</b>	<b>2</b>	<b>3</b>	
	Form	Cable Type	Cable Length	
Notes				

# M8 DISTRIBUTION SYSTEMS

For sensors and actuators

- with molded homerun cable
- Inline face or side mounting

Approvals:  Listed

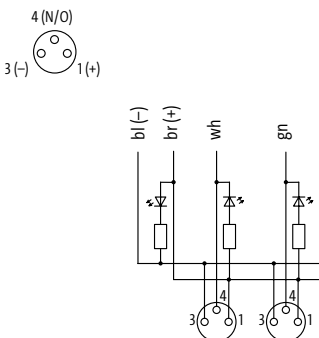

1 Form	84011	86011	88011	80011															
Type	NPN, 3-pole	NPN, 3-pole	NPN, 3-pole	NPN, 3-pole															
Contact layout	M8-Females 3-pole  for 1 signal per port																		
2 Cable Type	<b>Jacket Color</b> – No./diameter of wires <table border="1"> <thead> <tr> <th></th> <th>gray</th> <th>gray</th> <th>gray</th> <th>gray</th> </tr> </thead> <tbody> <tr> <td>PUR/PVC</td> <td>337 – 4 × 0.34 + 2 × 0.75 mm<sup>2</sup></td> <td>350 – 6 × 0.34 + 2 × 0.75 mm<sup>2</sup></td> <td>357 – 8 × 0.34 + 2 × 0.75 mm<sup>2</sup></td> <td>385 – 10 × 0.34 + 2 × 0.75 mm<sup>2</sup></td> </tr> <tr> <td>PUR (UL/CSA), robots/C-tracks</td> <td>334 – 4 × 0.34 + 2 × 0.75 mm<sup>2</sup></td> <td>356 – 6 × 0.34 + 2 × 0.75 mm<sup>2</sup></td> <td>359 – 8 × 0.34 + 2 × 0.75 mm<sup>2</sup></td> <td>384 – 10 × 0.34 + 2 × 0.75 mm<sup>2</sup></td> </tr> </tbody> </table>					gray	gray	gray	gray	PUR/PVC	337 – 4 × 0.34 + 2 × 0.75 mm <sup>2</sup>	350 – 6 × 0.34 + 2 × 0.75 mm <sup>2</sup>	357 – 8 × 0.34 + 2 × 0.75 mm <sup>2</sup>	385 – 10 × 0.34 + 2 × 0.75 mm <sup>2</sup>	PUR (UL/CSA), robots/C-tracks	334 – 4 × 0.34 + 2 × 0.75 mm <sup>2</sup>	356 – 6 × 0.34 + 2 × 0.75 mm <sup>2</sup>	359 – 8 × 0.34 + 2 × 0.75 mm <sup>2</sup>	384 – 10 × 0.34 + 2 × 0.75 mm <sup>2</sup>
	gray	gray	gray	gray															
PUR/PVC	337 – 4 × 0.34 + 2 × 0.75 mm <sup>2</sup>	350 – 6 × 0.34 + 2 × 0.75 mm <sup>2</sup>	357 – 8 × 0.34 + 2 × 0.75 mm <sup>2</sup>	385 – 10 × 0.34 + 2 × 0.75 mm <sup>2</sup>															
PUR (UL/CSA), robots/C-tracks	334 – 4 × 0.34 + 2 × 0.75 mm <sup>2</sup>	356 – 6 × 0.34 + 2 × 0.75 mm <sup>2</sup>	359 – 8 × 0.34 + 2 × 0.75 mm <sup>2</sup>	384 – 10 × 0.34 + 2 × 0.75 mm <sup>2</sup>															
3 Cable Length	<table border="1"> <tbody> <tr> <td>5.0 m</td> <td>0500</td> </tr> <tr> <td>10.0 m</td> <td>1000</td> </tr> </tbody> </table>				5.0 m	0500	10.0 m	1000											
5.0 m	0500																		
10.0 m	1000																		
Technical Data	<table border="1"> <tbody> <tr> <td>Operating voltage</td> <td>24 V DC</td> </tr> <tr> <td>Total current</td> <td>max. 8 A</td> </tr> <tr> <td>Protection</td> <td>IP65/IP67</td> </tr> <tr> <td>Temperature range</td> <td>-20...+80 °C, depending on cable quality</td> </tr> </tbody> </table>				Operating voltage	24 V DC	Total current	max. 8 A	Protection	IP65/IP67	Temperature range	-20...+80 °C, depending on cable quality							
Operating voltage	24 V DC																		
Total current	max. 8 A																		
Protection	IP65/IP67																		
Temperature range	-20...+80 °C, depending on cable quality																		
Contact Layout	<table border="1"> <tbody> <tr> <td>LED display</td> <td>LED (green): Power / LED (yellow): (S1)</td> </tr> <tr> <td>PIN 1</td> <td>(+)</td> </tr> <tr> <td>PIN 3</td> <td>(-)</td> </tr> <tr> <td>PIN 4</td> <td>(NO)/(S1)</td> </tr> </tbody> </table>				LED display	LED (green): Power / LED (yellow): (S1)	PIN 1	(+)	PIN 3	(-)	PIN 4	(NO)/(S1)							
LED display	LED (green): Power / LED (yellow): (S1)																		
PIN 1	(+)																		
PIN 3	(-)																		
PIN 4	(NO)/(S1)																		
Article No.	<table border="1"> <tbody> <tr> <td>The composition of your article number is explained on page 3.1.i</td> <td>8 0 0 0</td> <td>-</td> <td>-</td> <td>-</td> </tr> </tbody> </table>				The composition of your article number is explained on page 3.1.i	8 0 0 0	-	-	-										
The composition of your article number is explained on page 3.1.i	8 0 0 0	-	-	-															
	1 Form	2 Cable Type	3 Cable Length																
Notes																			

M8 Distribution Systems

# M8 DISTRIBUTION SYSTEMS

- For sensors and actuators
- with molded homerun cable
- Inline face or side mounting

Approvals:  UL Listed

**Exact8**  
4-way



**Exact8**  
6-way



**Exact8**  
8-way



**Exact8**  
10-way

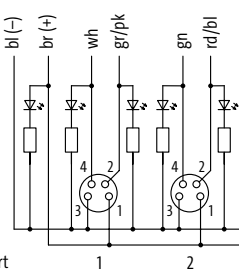

1 Form	84110	86110	88110	80110															
Type	PNP, 4-pole	PNP, 4-pole	PNP, 4-pole	PNP, 4-pole															
Contact layout	<p>M8-Females 4-pole</p> <p>4 (S1) 2 (S2) 3 (-) 1 (+)</p>  <p>for 2 signals per port</p>																		
2 Cable Type	<p><b>Jacket Color</b> – No./diameter of wires</p> <table border="1"> <thead> <tr> <th></th> <th>gray</th> <th>gray</th> <th>gray</th> <th>gray</th> </tr> </thead> <tbody> <tr> <td>PUR/PVC</td> <td>358 – 8 × 0.34 + 2 × 0.75 mm<sup>2</sup></td> <td>386 – 12 × 0.34 + 2 × 0.75 mm<sup>2</sup></td> <td>395 – 16 × 0.34 + 2 × 0.75 mm<sup>2</sup></td> <td>412 – 20 × 0.34 + 2 × 0.75 mm<sup>2</sup></td> </tr> <tr> <td>PUR (UL/CSA), robots/C-tracks</td> <td>360 – 8 × 0.34 + 2 × 0.75 mm<sup>2</sup></td> <td>389 – 12 × 0.34 + 2 × 0.75 mm<sup>2</sup></td> <td>396 – 16 × 0.34 + 2 × 0.75 mm<sup>2</sup></td> <td>411 – 20 × 0.34 + 2 × 0.75 mm<sup>2</sup></td> </tr> </tbody> </table>					gray	gray	gray	gray	PUR/PVC	358 – 8 × 0.34 + 2 × 0.75 mm <sup>2</sup>	386 – 12 × 0.34 + 2 × 0.75 mm <sup>2</sup>	395 – 16 × 0.34 + 2 × 0.75 mm <sup>2</sup>	412 – 20 × 0.34 + 2 × 0.75 mm <sup>2</sup>	PUR (UL/CSA), robots/C-tracks	360 – 8 × 0.34 + 2 × 0.75 mm <sup>2</sup>	389 – 12 × 0.34 + 2 × 0.75 mm <sup>2</sup>	396 – 16 × 0.34 + 2 × 0.75 mm <sup>2</sup>	411 – 20 × 0.34 + 2 × 0.75 mm <sup>2</sup>
	gray	gray	gray	gray															
PUR/PVC	358 – 8 × 0.34 + 2 × 0.75 mm <sup>2</sup>	386 – 12 × 0.34 + 2 × 0.75 mm <sup>2</sup>	395 – 16 × 0.34 + 2 × 0.75 mm <sup>2</sup>	412 – 20 × 0.34 + 2 × 0.75 mm <sup>2</sup>															
PUR (UL/CSA), robots/C-tracks	360 – 8 × 0.34 + 2 × 0.75 mm <sup>2</sup>	389 – 12 × 0.34 + 2 × 0.75 mm <sup>2</sup>	396 – 16 × 0.34 + 2 × 0.75 mm <sup>2</sup>	411 – 20 × 0.34 + 2 × 0.75 mm <sup>2</sup>															
3 Cable Length	<table border="1"> <tbody> <tr> <td>3.0 m</td> <td>0300</td> </tr> <tr> <td>5.0 m</td> <td>0500</td> </tr> <tr> <td>10.0 m</td> <td>1000</td> </tr> <tr> <td>15.0 m</td> <td>1500</td> </tr> </tbody> </table>				3.0 m	0300	5.0 m	0500	10.0 m	1000	15.0 m	1500							
3.0 m	0300																		
5.0 m	0500																		
10.0 m	1000																		
15.0 m	1500																		
Technical Data	<table border="1"> <tbody> <tr> <td>Operating voltage</td> <td>24 V DC</td> </tr> <tr> <td>Total current</td> <td>max. 8 A</td> </tr> <tr> <td>Protection</td> <td>IP65/IP67</td> </tr> <tr> <td>Temperature range</td> <td>-20...+80 °C, depending on cable quality</td> </tr> </tbody> </table>				Operating voltage	24 V DC	Total current	max. 8 A	Protection	IP65/IP67	Temperature range	-20...+80 °C, depending on cable quality							
Operating voltage	24 V DC																		
Total current	max. 8 A																		
Protection	IP65/IP67																		
Temperature range	-20...+80 °C, depending on cable quality																		
Contact Layout	<table border="1"> <tbody> <tr> <td>LED display</td> <td>LED (green): Power / LED (yellow): (S1) / LED (white): Signal (S2)</td> </tr> <tr> <td>PIN 1</td> <td>(+)</td> </tr> <tr> <td>PIN 2</td> <td>(NC)/(S2)</td> </tr> <tr> <td>PIN 3</td> <td>(-)</td> </tr> <tr> <td>PIN 4</td> <td>(NO)/(S1)</td> </tr> </tbody> </table>				LED display	LED (green): Power / LED (yellow): (S1) / LED (white): Signal (S2)	PIN 1	(+)	PIN 2	(NC)/(S2)	PIN 3	(-)	PIN 4	(NO)/(S1)					
LED display	LED (green): Power / LED (yellow): (S1) / LED (white): Signal (S2)																		
PIN 1	(+)																		
PIN 2	(NC)/(S2)																		
PIN 3	(-)																		
PIN 4	(NO)/(S1)																		
Article No.	<table border="1"> <tbody> <tr> <td>The composition of your article number is explained on page 3.1.i</td> <td>8</td> <td>0</td> <td>0</td> <td>0</td> <td>-</td> <td>-</td> <td>-</td> <td>-</td> </tr> </tbody> </table>				The composition of your article number is explained on page 3.1.i	8	0	0	0	-	-	-	-						
The composition of your article number is explained on page 3.1.i	8	0	0	0	-	-	-	-											
	1 Form		2 Cable Type		3 Cable Length														
Notes																			

# M8 DISTRIBUTION SYSTEMS

For sensors and actuators

- with molded homerun cable
- Inline face or side mounting



1 Form	84111	86111	88111	80111															
Type	NPN, 4-pole	NPN, 4-pole	NPN, 4-pole	NPN, 4-pole															
Contact layout	M8-Females 4-pole 4 (S1) 2 (S2) 3 (-) 1 (+) 																		
2 Cable Type	<b>Jacket Color</b> – No./diameter of wires <table border="1"> <thead> <tr> <th></th> <th>gray</th> <th>gray</th> <th>gray</th> <th>gray</th> </tr> </thead> <tbody> <tr> <td>PUR/PVC</td> <td>358 – 8 × 0.34 + 2 × 0.75 mm<sup>2</sup></td> <td>386 – 12 × 0.34 + 2 × 0.75 mm<sup>2</sup></td> <td>395 – 16 × 0.34 + 2 × 0.75 mm<sup>2</sup></td> <td>412 – 20 × 0.34 + 2 × 0.75 mm<sup>2</sup></td> </tr> <tr> <td>PUR (UL/CSA), robots/C-tracks</td> <td>360 – 8 × 0.34 + 2 × 0.75 mm<sup>2</sup></td> <td>389 – 12 × 0.34 + 2 × 0.75 mm<sup>2</sup></td> <td>396 – 16 × 0.34 + 2 × 0.75 mm<sup>2</sup></td> <td>411 – 20 × 0.34 + 2 × 0.75 mm<sup>2</sup></td> </tr> </tbody> </table>					gray	gray	gray	gray	PUR/PVC	358 – 8 × 0.34 + 2 × 0.75 mm <sup>2</sup>	386 – 12 × 0.34 + 2 × 0.75 mm <sup>2</sup>	395 – 16 × 0.34 + 2 × 0.75 mm <sup>2</sup>	412 – 20 × 0.34 + 2 × 0.75 mm <sup>2</sup>	PUR (UL/CSA), robots/C-tracks	360 – 8 × 0.34 + 2 × 0.75 mm <sup>2</sup>	389 – 12 × 0.34 + 2 × 0.75 mm <sup>2</sup>	396 – 16 × 0.34 + 2 × 0.75 mm <sup>2</sup>	411 – 20 × 0.34 + 2 × 0.75 mm <sup>2</sup>
	gray	gray	gray	gray															
PUR/PVC	358 – 8 × 0.34 + 2 × 0.75 mm <sup>2</sup>	386 – 12 × 0.34 + 2 × 0.75 mm <sup>2</sup>	395 – 16 × 0.34 + 2 × 0.75 mm <sup>2</sup>	412 – 20 × 0.34 + 2 × 0.75 mm <sup>2</sup>															
PUR (UL/CSA), robots/C-tracks	360 – 8 × 0.34 + 2 × 0.75 mm <sup>2</sup>	389 – 12 × 0.34 + 2 × 0.75 mm <sup>2</sup>	396 – 16 × 0.34 + 2 × 0.75 mm <sup>2</sup>	411 – 20 × 0.34 + 2 × 0.75 mm <sup>2</sup>															
3 Cable Length	<table border="1"> <tbody> <tr> <td>5.0 m</td> <td>0500</td> </tr> <tr> <td>10.0 m</td> <td>1000</td> </tr> </tbody> </table>				5.0 m	0500	10.0 m	1000											
5.0 m	0500																		
10.0 m	1000																		
Technical Data	<table border="1"> <tbody> <tr> <td>Operating voltage</td> <td>24 V DC</td> </tr> <tr> <td>Total current</td> <td>max. 8 A</td> </tr> <tr> <td>Protection</td> <td>IP65/IP67</td> </tr> <tr> <td>Temperature range</td> <td>-20...+80 °C, depending on cable quality</td> </tr> </tbody> </table>				Operating voltage	24 V DC	Total current	max. 8 A	Protection	IP65/IP67	Temperature range	-20...+80 °C, depending on cable quality							
Operating voltage	24 V DC																		
Total current	max. 8 A																		
Protection	IP65/IP67																		
Temperature range	-20...+80 °C, depending on cable quality																		
Contact Layout	<table border="1"> <tbody> <tr> <td>LED display</td> <td>LED (green): Power / LED (yellow): (S1) / LED (white): Signal (S2)</td> </tr> <tr> <td>PIN 1</td> <td>(+)</td> </tr> <tr> <td>PIN 2</td> <td>(NC)/(S2)</td> </tr> <tr> <td>PIN 3</td> <td>(-)</td> </tr> <tr> <td>PIN 4</td> <td>(NO)/(S1)</td> </tr> </tbody> </table>				LED display	LED (green): Power / LED (yellow): (S1) / LED (white): Signal (S2)	PIN 1	(+)	PIN 2	(NC)/(S2)	PIN 3	(-)	PIN 4	(NO)/(S1)					
LED display	LED (green): Power / LED (yellow): (S1) / LED (white): Signal (S2)																		
PIN 1	(+)																		
PIN 2	(NC)/(S2)																		
PIN 3	(-)																		
PIN 4	(NO)/(S1)																		
Article No.	<table border="1"> <tbody> <tr> <td>The composition of your article number is explained on page 3.1.i</td> <td>8 0 0 0</td> <td>-</td> <td>-</td> <td>-</td> </tr> </tbody> </table>				The composition of your article number is explained on page 3.1.i	8 0 0 0	-	-	-										
The composition of your article number is explained on page 3.1.i	8 0 0 0	-	-	-															
	1 Form	2 Cable Type	3 Cable Length																
Notes																			



# M8 DISTRIBUTION SYSTEMS

For sensors and actuators

- Base modules
- Inline face or side mounting

Approvals:  Listed

**Exact8**  
4-way



**Exact8**  
6-way



**Exact8**  
8-way



**Exact8**  
10-way



1 Form	84000	86000	88000	80000
--------	-------	-------	-------	-------

Type	PNP, 3-pole	PNP, 3-pole	PNP, 3-pole	PNP, 3-pole
------	-------------	-------------	-------------	-------------

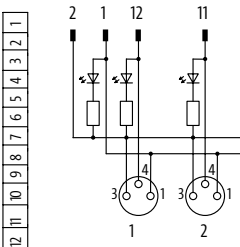
Contact layout	<p>M8-Females 3-pole</p>   <p>for 1 signal per port</p>			
----------------	--	--	--	--

### Technical Data

Operating voltage	24 V DC
Operating current per contact	max. 2 A
Total current	max. 8 A
Protection	IP65/IP67
Temperature range	-20...+70 °C, depending on cable quality

### Contact Layout

LED display	LED (green): Power / LED (yellow): (S1)
PIN 1	(+)
PIN 3	(-)
PIN 4	(NO)/(S1)

### Article No.

The composition of your article number is explained on page 3.1.i	<b>8 0 0 0</b>	-	-	<b>0 0 0</b>	<b>0 0 0 0</b>
	<b>1 Form</b>				

### Notes

# M8 DISTRIBUTION SYSTEMS

For sensors and actuators

- Base modules
- Inline face or side mounting

Approvals:  Listed

**Exact8**  
4-way



**Exact8**  
6-way



**Exact8**  
8-way



**Exact8**  
10-way



## 1 Form

**84001**

**86001**

**88001**

**80001**

Type  
Contact layout

NPN, 3-pole

NPN, 3-pole

NPN, 3-pole

NPN, 3-pole

M8-Females 3-pole

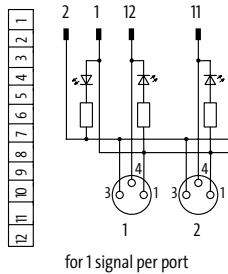
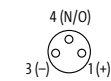

## Technical Data

Operating voltage	24 V DC
Operating current per contact	max. 2 A
Total current	max. 8 A
Protection	IP65/IP67
Temperature range	-20...+70 °C, depending on cable quality

## Contact Layout

LED display	LED (green): Power / LED (yellow): (S1)
PIN 1	(+)
PIN 3	(-)
PIN 4	(NO)/(S1)

## Article No.

The composition of your article number is explained on page 3.1.i

8 0 0 0

-

-----

-

0 0 0

0 0 0 0

**1** Form

Notes

# M8 DISTRIBUTION SYSTEMS

For sensors and actuators

- Base modules
- Inline face or side mounting

Approvals:  UL Listed

**Exact8**  
4-way











**Exact8**  
6-way

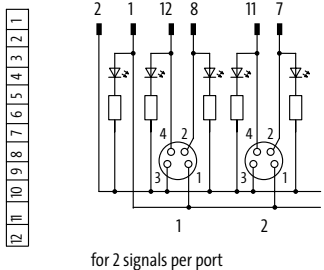

**Exact8**  
8-way

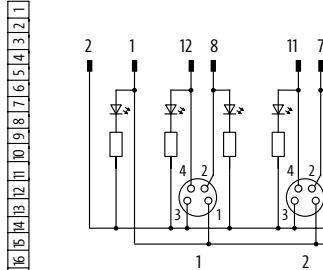

1 Form	84100	86100	88100
Type	PNP, 4-pole	PNP, 4-pole	PNP, 4-pole
Contact layout	<p>M8 Females 4-pole</p> <p>4 (S1)  2 (S2)  3 (-)  1 (+) </p>  <p>for 2 signals per port</p>	<p>M8-Females 4-pole</p> <p>4 (S1)  2 (S2)  3 (-)  1 (+) </p>  <p>for 2 signals per port</p>	
<b>Technical Data</b>			
Operating voltage	24 V DC		
Operating current per contact	max. 2 A		
Total current	max. 8 A		
Protection	IP65/IP67		
Temperature range	-20...+70 °C, depending on cable quality		
<b>Contact Layout</b>			
LED display	LED (green): Power / LED (yellow): (S1) / LED (white): Signal (S2)		
PIN 1	(+) / (S1)		
PIN 2	(NC)/(S2)		
PIN 3	(-) / (S2)		
PIN 4	(NO)/(S1)		
<b>Article No.</b>			
The composition of your article number is explained on page 3.1.i	<div style="display: flex; justify-content: space-around; align-items: center;"> <span style="border-bottom: 1px solid black; padding: 0 5px;">8</span> <span style="border-bottom: 1px solid black; padding: 0 5px;">0</span> <span style="border-bottom: 1px solid black; padding: 0 5px;">0</span> <span style="border-bottom: 1px solid black; padding: 0 5px;">0</span> <span style="font-size: 2em;">-</span> <span style="border-bottom: 1px solid black; padding: 0 5px;"> </span> <span style="border-bottom: 1px solid black; padding: 0 5px;"> </span> <span style="border-bottom: 1px solid black; padding: 0 5px;"> </span> <span style="border-bottom: 1px solid black; padding: 0 5px;"> </span> <span style="font-size: 2em;">-</span> <span style="border-bottom: 1px solid black; padding: 0 5px;">0</span> <span style="border-bottom: 1px solid black; padding: 0 5px;">0</span> <span style="border-bottom: 1px solid black; padding: 0 5px;">0</span> <span style="border-bottom: 1px solid black; padding: 0 5px;">0</span> </div>		
	<b>1 Form</b>		
Notes			

# M8 DISTRIBUTION SYSTEMS

For sensors and actuators

– Connection cap with homerun cable

Approvals:  Listed

**Exact8**

Connection cap short

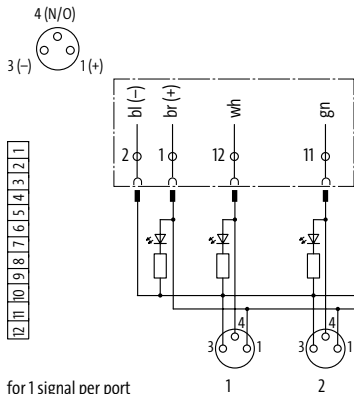

1 Form	84049	86049	88049	80049															
Type	for 4-way distribution box, 3-pole Spring clamp plug-in terminals	for 6-way distribution box, 3-pole Spring clamp plug-in terminals	for 8-way distribution box, 3-pole Spring clamp plug-in terminals	for 10-way distribution box, 3-pole Spring clamp plug-in terminals															
Contact layout	<p>M8-Females 3-pole</p>  <p>for 1 signal per port</p>																		
2 Cable Type	<p><b>Jacket Color</b> – No./diameter of wires</p> <table border="1"> <thead> <tr> <th></th> <th>gray</th> <th>gray</th> <th>gray</th> <th>gray</th> </tr> </thead> <tbody> <tr> <td>PUR/PVC</td> <td>337 – 4 × 0.34 + 2 × 0.75 mm<sup>2</sup></td> <td>350 – 6 × 0.34 + 2 × 0.75 mm<sup>2</sup></td> <td>357 – 8 × 0.34 + 2 × 0.75 mm<sup>2</sup></td> <td>385 – 10 × 0.34 + 2 × 0.75 mm<sup>2</sup></td> </tr> <tr> <td>PUR (UL/CSA), robots/C-tracks</td> <td>334 – 4 × 0.34 + 2 × 0.75 mm<sup>2</sup></td> <td>356 – 6 × 0.34 + 2 × 0.75 mm<sup>2</sup></td> <td>359 – 8 × 0.34 + 2 × 0.75 mm<sup>2</sup></td> <td>384 – 10 × 0.34 + 2 × 0.75 mm<sup>2</sup></td> </tr> </tbody> </table>					gray	gray	gray	gray	PUR/PVC	337 – 4 × 0.34 + 2 × 0.75 mm <sup>2</sup>	350 – 6 × 0.34 + 2 × 0.75 mm <sup>2</sup>	357 – 8 × 0.34 + 2 × 0.75 mm <sup>2</sup>	385 – 10 × 0.34 + 2 × 0.75 mm <sup>2</sup>	PUR (UL/CSA), robots/C-tracks	334 – 4 × 0.34 + 2 × 0.75 mm <sup>2</sup>	356 – 6 × 0.34 + 2 × 0.75 mm <sup>2</sup>	359 – 8 × 0.34 + 2 × 0.75 mm <sup>2</sup>	384 – 10 × 0.34 + 2 × 0.75 mm <sup>2</sup>
	gray	gray	gray	gray															
PUR/PVC	337 – 4 × 0.34 + 2 × 0.75 mm <sup>2</sup>	350 – 6 × 0.34 + 2 × 0.75 mm <sup>2</sup>	357 – 8 × 0.34 + 2 × 0.75 mm <sup>2</sup>	385 – 10 × 0.34 + 2 × 0.75 mm <sup>2</sup>															
PUR (UL/CSA), robots/C-tracks	334 – 4 × 0.34 + 2 × 0.75 mm <sup>2</sup>	356 – 6 × 0.34 + 2 × 0.75 mm <sup>2</sup>	359 – 8 × 0.34 + 2 × 0.75 mm <sup>2</sup>	384 – 10 × 0.34 + 2 × 0.75 mm <sup>2</sup>															
3 Cable Length	<table border="1"> <tbody> <tr> <td>3.0 m</td> <td>0300</td> </tr> <tr> <td>5.0 m</td> <td>0500</td> </tr> <tr> <td>10.0 m</td> <td>1000</td> </tr> <tr> <td>15.0 m</td> <td>1500</td> </tr> </tbody> </table>				3.0 m	0300	5.0 m	0500	10.0 m	1000	15.0 m	1500							
3.0 m	0300																		
5.0 m	0500																		
10.0 m	1000																		
15.0 m	1500																		
Technical Data	<table border="1"> <tbody> <tr> <td>Total current</td> <td>max. 8 A</td> </tr> <tr> <td>Temperature range</td> <td>-20...+80 °C, depending on cable quality</td> </tr> </tbody> </table>				Total current	max. 8 A	Temperature range	-20...+80 °C, depending on cable quality											
Total current	max. 8 A																		
Temperature range	-20...+80 °C, depending on cable quality																		
Article No.	<p>The composition of your article number is explained on page 3.1.i</p> <p><b>8 0 0 0</b> – _____ – _____</p>																		
	<b>1</b> Form	<b>2</b> Cable Type	<b>3</b> Cable Length																
Notes																			

# M8 DISTRIBUTION SYSTEMS

For sensors and actuators

– Connection cap with homerun cable



**Exact8**

Connection cap short



**Exact8**

Connection cap long



1 Form	84149	86149	88149												
Type	for 4-way distribution box, 4-pole Spring clamp plug-in terminals	for 6-way distribution box, 4-pole Spring clamp plug-in terminals	for 8-way distribution box, 4-pole Spring clamp plug-in terminals												
Contact layout	<p>M8-Females 4-pole</p> <p>4 (S1) 2 (S2) 3 (-) 1 (+)</p>	<p>M8-Females 4-pole</p> <p>4 (S1) 2 (S2) 3 (-) 1 (+)</p>													
2 Cable Type	<p><b>Jacket Color</b> – No./diameter of wires</p> <table border="1"> <thead> <tr> <th></th> <th>gray</th> <th>gray</th> <th>gray</th> </tr> </thead> <tbody> <tr> <td>PUR/PVC</td> <td>358 – 8 × 0.34 + 2 × 0.75 mm<sup>2</sup></td> <td>386 – 12 × 0.34 + 2 × 0.75 mm<sup>2</sup></td> <td>395 – 16 × 0.34 + 2 × 0.75 mm<sup>2</sup></td> </tr> <tr> <td>PUR (UL/CSA), robots/Ctracks</td> <td>360 – 8 × 0.34 + 2 × 0.75 mm<sup>2</sup></td> <td>389 – 12 × 0.34 + 2 × 0.75 mm<sup>2</sup></td> <td>396 – 16 × 0.34 + 2 × 0.75 mm<sup>2</sup></td> </tr> </tbody> </table>				gray	gray	gray	PUR/PVC	358 – 8 × 0.34 + 2 × 0.75 mm <sup>2</sup>	386 – 12 × 0.34 + 2 × 0.75 mm <sup>2</sup>	395 – 16 × 0.34 + 2 × 0.75 mm <sup>2</sup>	PUR (UL/CSA), robots/Ctracks	360 – 8 × 0.34 + 2 × 0.75 mm <sup>2</sup>	389 – 12 × 0.34 + 2 × 0.75 mm <sup>2</sup>	396 – 16 × 0.34 + 2 × 0.75 mm <sup>2</sup>
	gray	gray	gray												
PUR/PVC	358 – 8 × 0.34 + 2 × 0.75 mm <sup>2</sup>	386 – 12 × 0.34 + 2 × 0.75 mm <sup>2</sup>	395 – 16 × 0.34 + 2 × 0.75 mm <sup>2</sup>												
PUR (UL/CSA), robots/Ctracks	360 – 8 × 0.34 + 2 × 0.75 mm <sup>2</sup>	389 – 12 × 0.34 + 2 × 0.75 mm <sup>2</sup>	396 – 16 × 0.34 + 2 × 0.75 mm <sup>2</sup>												
3 Cable Length	<table border="1"> <tbody> <tr> <td>3.0 m</td> <td>0300</td> </tr> <tr> <td>5.0 m</td> <td>0500</td> </tr> <tr> <td>10.0 m</td> <td>1000</td> </tr> <tr> <td>15.0 m</td> <td>1500</td> </tr> </tbody> </table>			3.0 m	0300	5.0 m	0500	10.0 m	1000	15.0 m	1500				
3.0 m	0300														
5.0 m	0500														
10.0 m	1000														
15.0 m	1500														
Technical Data	<table border="1"> <tbody> <tr> <td>Total current</td> <td>max. 8 A</td> </tr> <tr> <td>Temperature range</td> <td>-20...+80 °C, depending on cable quality</td> </tr> </tbody> </table>			Total current	max. 8 A	Temperature range	-20...+80 °C, depending on cable quality								
Total current	max. 8 A														
Temperature range	-20...+80 °C, depending on cable quality														
Article No.	<p>The composition of your article number is explained on page 3.1.i</p> <p><b>8 0 0 0</b> – _____ – _____</p>														
	<b>1 Form</b>	<b>2 Cable Type</b>	<b>3 Cable Length</b>												
Notes															

# M8 DISTRIBUTION SYSTEMS

For sensors and actuators

– Connection cap without homerun cable

– Field-wireable

**Exact8**

Connection cap short



**Exact8**

Connection cap long



## 1 Form

**84949**

**80949**

Type

for 4-way distribution box, 3/4-pole, for 4...10-way, 3-pole

6-, and 8-way distribution box, 4-pole

Spring clamp plug-in terminals

Spring clamp plug-in terminals

Contact layout

3-pole M8-Females 4-pole

M8-Females 4-pole

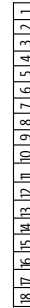
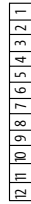
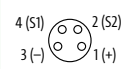
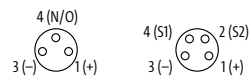

## Technical Data

Total current	max. 8 A
Housing	Plastic, flame retardant
Temperature range	-20...+80 °C

## Article No.

The composition of your article number is explained on page 3.1.i

8 0 0 0

- - - - -

0 0 0

0 0 0 0

**1** Form

Notes

# M8 DISTRIBUTION SYSTEMS

For sensors and actuators

– Sets (basic module and cap)

– Inline face or side mounting

**Exact8**

4-way



**Exact8**

6-way



**Exact8**

8-way



**Exact8**

10-way



Approvals: **UL**  
Listed

1 Form		84040	86040	88040	80040
Type		3-pole	3-pole	3-pole	3-pole
Contact layout		<p>M8-Females 3-pole</p> <p>for 1 signal per port</p>			
2 Cable Type		<b>Jacket Color</b> – No./diameter of wires			
		<b>gray</b>	<b>gray</b>	<b>gray</b>	<b>gray</b>
PUR (UL/CSA), robots/C-tracks		<b>334</b> – 4 × 0.34 + 2 × 0.75 mm <sup>2</sup>	<b>356</b> – 6 × 0.34 + 2 × 0.75 mm <sup>2</sup>	<b>359</b> – 8 × 0.34 + 2 × 0.75 mm <sup>2</sup>	<b>384</b> – 10 × 0.34 + 2 × 0.75 mm <sup>2</sup>
3 Cable Length					
3.0 m		<b>0300</b>			
5.0 m		<b>0500</b>			
10.0 m		<b>1000</b>			
15.0 m		<b>1500</b>			
Technical Data					
Operating voltage		24 V DC			
Total current		max. 8 A			
Protection		IP67 inserted and tightened (EN 60529)			
Temperature range		-20...+80 °C, depending on cable quality			
Contact Layout					
LED display		LED (green): Power / LED (yellow): (S1)			
PIN 1		(+)			
PIN 3		(-)			
PIN 4		(NO)/(S1)			
Article No.					
The composition of your article number is explained on page 3.1.i		<b>8 0 0 0</b>	-	-	-
		<b>1</b>	<b>Form</b>	<b>2</b>	<b>Cable Type</b>
		<b>3</b>	<b>Cable Length</b>		
Notes					

# M8 DISTRIBUTION SYSTEMS

For sensors

- M12 plug connection
- 8-pole
- Inline face or side mounting

Approvals:  Listed

**Exact8**

4-way



**Exact8**

6-way



## 1 Form

**84070**

**86070**

Type  
Contact layout

3-pole

3-pole

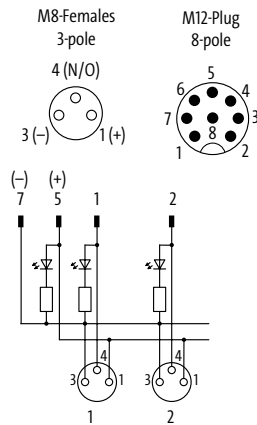

for 1 signal per port

## Technical Data

Operating voltage	24 V DC
Operating current per contact	max. 2 A
Protection	IP65/IP67
Housing	Plastic, flame retardant
Temperature range	-20...+70 °C, depending on cable quality

## Contact Layout

LED display	LED (green): Power / LED (yellow): (S1)
PIN 1	(+)
PIN 3	(-)
PIN 4	(NO)/(S1)

## Article No.

The composition of your article number is explained on page 3.1.i

8 0 0 0

-

-----

0 0 0

0 0 0 0

**1** Form

Notes



# M8 DISTRIBUTION SYSTEMS

For sensors

- M12 plug connection
- 12-pole
- Inline face or side mounting

Approvals:  Listed

**Exact8**  
4-way



**Exact8**  
6-way



**Exact8**  
8-way



**Exact8**  
10-way

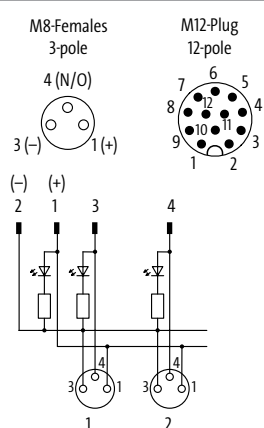

<b>1 Form</b>	<b>84060</b>	<b>86060</b>	<b>88060</b>	<b>80060</b>
Type	3-pole	3-pole	3-pole	3-pole
Contact layout	 <p>for 1 signal per port</p>			
<b>Technical Data</b>				
Operating voltage	24 V DC			
Operating current per contact	max. 1.5 A			
Protection	IP67 inserted and tightened (EN 60529)			
Housing	Plastic, flame retardant			
Temperature range	-20...+70 °C, depending on cable quality			
<b>Contact Layout</b>				
LED display	LED (green): Power / LED (yellow): (S1)			
PIN 1	(+)			
PIN 3	(-)			
PIN 4	(NO)/(S1)			
<b>Article No.</b>				
The composition of your article number is explained on page 3.1.i	<u>8</u> <u>0</u> <u>0</u> <u>0</u>	-	<u>0</u> <u>0</u> <u>0</u>	<u>0</u> <u>0</u> <u>0</u> <u>0</u>
	<b>1 Form</b>			
<b>Notes</b>				

# M8 DISTRIBUTION SYSTEMS

For sensors

- M12 plug connection
- 12-pole
- Inline face or side mounting

Approvals:  Listed

**Exact8**

4-way



## 1 Form 84160

Type 4-pole

Contact layout

M8-Females  
4-pole

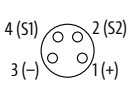

M12-Plug  
12-pole

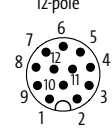

(-) (+)

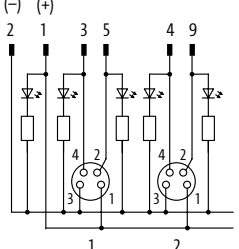

for 2 signals per port

### Technical Data

Operating voltage	24 V DC
Operating current per contact	max. 1.5 A
Protection	IP67 inserted and tightened (EN 60529)
Housing	Plastic, flame retardant
Temperature range	-20...+70 °C, depending on cable quality

### Contact Layout

LED display	LED (green): Power / LED (yellow): (S1) / LED (white): Signal (S2)
PIN 1	(+)
PIN 2	(NC)/(S2)
PIN 3	(-)
PIN 4	(NO)/(S1)

### Article No.

The composition of your article number is explained on page 3.1.i

<u>8</u> <u>0</u> <u>0</u> <u>0</u>	-	<u>8</u> <u>4</u> <u>1</u> <u>6</u> <u>0</u>	-	<u>0</u> <u>0</u> <u>0</u>	<u>0</u> <u>0</u> <u>0</u> <u>0</u>
-------------------------------------	---	--	---	----------------------------	-------------------------------------

**1** Form

Notes

# M8 DISTRIBUTION SYSTEMS

Plug accessories			Art-No.
	<b>Torque wrench set</b> M8 (0.4 Nm, SW9)	M8 data connectors	7000-99101-0000000
	<b>Screw plug M8 x 1 mm (for female)</b> Plastic, hex without gasket	Quantity: 10 pcs.	3858627
	<b>Adapter M8/M12</b> 3-pole 4-pole	M8 Distribution Systems M8 Distribution Systems	7000-88521-0000000 7000-88531-0000000
	<b>Label plates</b> KES 20 x 8 (white)	(10 pieces/2 plates)	996067
	<b>T-coupler (Nano)</b> Distribution function (NO)	M8 distribution systems, 4-pole	7000-88602-0000000
	<b>Screw plug M12 x 1 mm (for male)</b> Plastic	Quantity: 4 pcs.	56951
Homerun cable accessories			Art-No.
	<b>Connection cap short</b> Spring clamp terminals, 12-pole	4-way distribution box, 3/4-pole, 4...10-way, 3-pole Cable diameter (7.4...13 mm)	8000-84949-0000000
	<b>Connection cap long</b> Spring clamp terminals, 18-pole	6-, and 8-way distribution box, 4-pole Cable diameter (7.4...13 mm)	8000-80949-0000000
	<b>Cable rings (50 m), 3-pole, PUR/PVC</b> 4x0.34 + 2x0.75 mm <sup>2</sup> 4x0.34 + 2x0.75 mm <sup>2</sup>	4-way distribution boxes M8 4-way distribution boxes M8	8000-00000-3375000 8000-00000-3345000

# M8 DISTRIBUTION SYSTEMS

Homerun cable accessories			Art-No.
	<b>Cable rings (50 m), 3-pole, PUR/PVC</b> 6×0.34 + 2×0.75 mm <sup>2</sup>	6-way distribution boxes M8	8000-00000-3505000
	6×0.34 + 2×0.75 mm <sup>2</sup>	6-way distribution boxes M8	8000-00000-3565000
	<b>Cable rings (50 m), 3-pole, PUR/PVC</b> 8×0.34 + 2×0.75 mm <sup>2</sup>	8-way distribution boxes M8	8000-00000-3575000
	8×0.34 + 2×0.75 mm <sup>2</sup>	8-way distribution boxes M8	8000-00000-3595000
	<b>Cable rings (50 m), 3-pole, PUR/PVC</b> 10×0.34 + 2×0.75 mm <sup>2</sup>	10-way distribution boxes M8	8000-00000-3855000
	10×0.34 + 2×0.75 mm <sup>2</sup>	10-way distribution boxes M8	8000-00000-3845000
	<b>Cable rings (50 m), 4-pole, PUR/PVC</b> 8×0.34 + 2×0.75 mm <sup>2</sup>	4-way distribution boxes M8	8000-00000-3585000
	8×0.34 + 2×0.75 mm <sup>2</sup>	4-way distribution boxes M8	8000-00000-3605000
	<b>Cable rings (50 m), 4-pole, PUR/PVC</b> 12×0.34 + 2×0.75 mm <sup>2</sup>	6-way distribution boxes M8	8000-00000-3865000
	12×0.34 + 2×0.75 mm <sup>2</sup>	6-way distribution boxes M8	8000-00000-3895000
	<b>Cable rings (50 m), 4-pole, PUR/PVC</b> 16×0.34 + 2×0.75 mm <sup>2</sup>	8-way distribution boxes M8	8000-00000-3955000
	16×0.34 + 2×0.75 mm <sup>2</sup>	8-way distribution boxes M8	8000-00000-3965000
	<b>Cable rings (50 m), 4-pole, PUR (UL/CSA), halogen free</b>		
	20×0.34 + 2×0.75 mm <sup>2</sup>	10-way distribution boxes M8	8000-00000-4115000
	20×0.34 + 2×0.75 mm <sup>2</sup>	10-way distribution boxes M8	8000-00000-4125000

## M8 Distribution Systems Technical Data

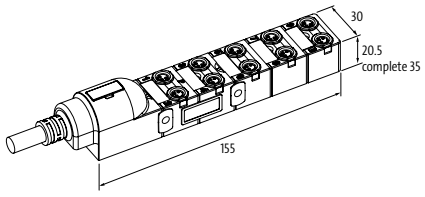
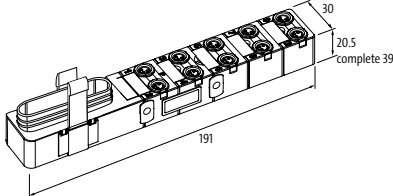
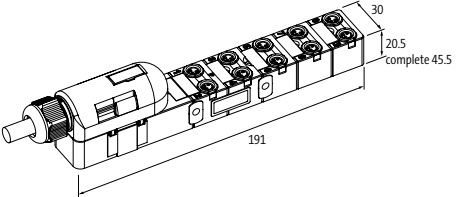
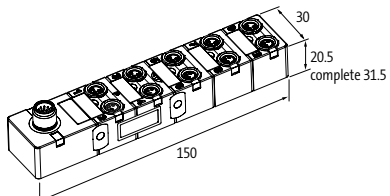
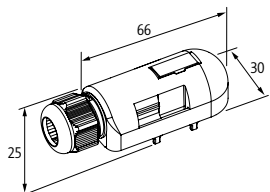
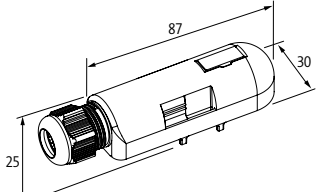
	<b>Description</b>  <b>Exact8</b> Molded homerun cable	<b>4-way</b>  96 mm	<b>6-way</b>  109 mm	<b>8-way</b>  132 mm	<b>10-way</b>  155 mm
	<b>Description</b>  <b>Exact8</b> Basic module 3-pole Basic module 4-pole	<b>4-way</b>  132 mm 132 mm	<b>6-way</b>  145 mm 166 mm	<b>8-way</b>  168 mm 189 mm	<b>10-way</b>  191 mm –
	<b>Description</b>  <b>Exact8</b> Sets 3-pole Sets 4-pole	<b>4-way</b>  132 mm 132 mm	<b>6-way</b>  145 mm 166 mm	<b>8-way</b>  168 mm 189 mm	<b>10-way</b>  191 mm –
	<b>Description</b>  <b>Exact8</b> M12 plug connection	<b>4-way</b>  91.5 mm	<b>6-way</b>  104 mm	<b>8-way</b>  127 mm	<b>10-way</b>  150 mm
	<b>Description</b>  <b>Exact8</b> Short connection cap				
	<b>Description</b>  <b>Exact8</b> Long connection cap				



## M12 DISTRIBUTION SYSTEMS METAL

- Rugged
- Resistant to media
- Sealed

### POTTED FORMS FOR HARSH ENVIRONMENTS

- Metal housing withstands mechanical and thermal stress, with molded cable or maintenance-friendly M23 plug connection
- High quality PUR cable: suitable for C-tracks, halogen-free, wider wire cross sections for higher current capacity
- Shielded models for sensitive digital or analog signals for an EMC compatible installation
- Universal configuration - contacts designed 1:1
- Fully potted

### With molded homerun cable or M23 plug connection



#### MVP12 Metal

- 4-, 8-way
- With LED for PNP or NPN signals
- Without LED for analog signals and voltages up to 125 VAC/DC
- With PUR homerun cable or M23 connection

*Page 4.12.1*



#### MVP12 Metal UNIVERSAL

- 4-way
- M12 Pin 1, 2, 3, and 4 freely configurable

*Page 4.12.8*

# M12 DISTRIBUTION SYSTEMS (METAL)

For sensors and actuators

– with molded homerun cable

– unshielded

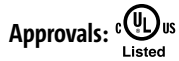

## MVP12 Metal

4-way  
for PNP signals 24 V DC



## MVP12 Metal

8-way  
for PNP signals 24 V DC



<b>1 Form</b>	<b>54510</b>	<b>58510</b>								
Type	PNP, 5-pole	PNP, 5-pole								
Contact layout	<p>for 2 signals per port</p>									
<b>2 Cable Type</b>	<b>Jacket Color</b> – No./diameter of wires									
	<b>gray</b>	<b>gray</b>								
PUR (UL/CSA), robots/Ctracks	<b>448</b> – 8 × 0.5 + 3 × 1.0 mm <sup>2</sup>	<b>452</b> – 16 × 0.5 + 3 × 1.0 mm <sup>2</sup>								
<b>3 Cable Length</b>										
3.0 m	<b>0300</b>									
5.0 m	<b>0500</b>									
10.0 m	<b>1000</b>									
15.0 m	<b>1500</b>									
<b>Technical Data</b>										
Operating voltage	24 V DC									
Total current	max. 7.5 A									
Protection	IP65, IP67, IP68									
Temperature range	-20...+90 °C, depending on cable quality									
<b>Contact Layout</b>										
LED display	LED (green): Power / LED (yellow): (S1/S2)									
PIN 1	(+) (N/C)/(S2)									
PIN 2	(-)									
PIN 3	(NO)/(S1)									
PIN 4	(Earth)									
PIN 5										
<b>Article No.</b>										
The composition of your article number is explained on page 3.1.i	<table border="1"> <tr> <td><b>8</b></td> <td><b>0</b></td> <td><b>0</b></td> <td><b>0</b></td> <td>-</td> <td>-</td> <td>-</td> <td>-</td> </tr> </table>		<b>8</b>	<b>0</b>	<b>0</b>	<b>0</b>	-	-	-	-
<b>8</b>	<b>0</b>	<b>0</b>	<b>0</b>	-	-	-	-			
	<b>1 Form</b>	<b>2 Cable Type</b>	<b>3 Cable Length</b>							
<b>Notes</b>										

M12 Distribution Systems (Metal)

# M12 DISTRIBUTION SYSTEMS (METAL)

For sensors and actuators

– with molded homerun cable

– unshielded

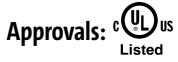

## MVP12 Metal

8-way  
with potential separation



## MVP12 Metal

4-way  
without LED



1 Form		58 610	54 512
Type		PNP, 5-pole	without LED, 5-pole (for analog signals)
Contact layout		<p>M12-Females 5-pole</p> <p>for 2 signals per port</p>	<p>M12-Females 5-pole</p> <p>for 2 signals per port</p>
2 Cable Type		Jacket Color – No./diameter of wires	
		gray	gray
PUR (UL/CSA), robots/C-tracks		403 – 16 × 0.34 + 5 × 0.75 mm <sup>2</sup>	448 – 8 × 0.5 + 3 × 1.0 mm <sup>2</sup>
3 Cable Length			
3.0 m		0300	
5.0 m		0500	
10.0 m		1000	
15.0 m		1500	
Technical Data			
Operating voltage	24 V DC	max. 125 V AC/DC	
Total current	max. 7.5 A		
Protection	IP65, IP67, IP68		
Temperature range	-20...+90 °C, depending on cable quality		
Contact Layout			
LED display	LED (green): Power / LED (yellow): (S1/S2)	–	
PIN 1	(+)		
PIN 2	(NC)/(S2)		
PIN 3	(-)		
PIN 4	(NO)/(S1)		
PIN 5	(Earth)		
Article No.			
The composition of your article number is explained on page 3.1.i		<div style="display: flex; justify-content: space-around; align-items: center;"> <span style="border-bottom: 1px solid black; padding: 0 5px;">8</span> <span style="border-bottom: 1px solid black; padding: 0 5px;">0</span> <span style="border-bottom: 1px solid black; padding: 0 5px;">0</span> <span style="border-bottom: 1px solid black; padding: 0 5px;">0</span> <span style="font-size: 2em;">-</span> <span style="border-bottom: 1px solid black; padding: 0 5px;">-</span> <span style="border-bottom: 1px solid black; padding: 0 5px;">-</span> <span style="border-bottom: 1px solid black; padding: 0 5px;">-</span> </div>	
		<b>1</b> Form	<b>2</b> Cable Type
		<b>3</b> Cable Length	
Notes			

M12 Distribution Systems (Metal)



# M12 DISTRIBUTION SYSTEMS (METAL)

For sensors and actuators

– with molded homerun cable

– unshielded

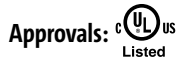

**MVP12 Metal**

8-way  
without LED



**MVP12 Metal**

8-way  
for NPN signals 24 V DC



1 Form		58512	58511
Type		without LED, 5-pole (for analog signals)	NPN, 5-pole
Contact layout		<p>for 2 signals per port</p>	<p>for 2 signals per port</p>
2 Cable Type	Jacket Color – No./diameter of wires	gray	gray
		452 – 16 × 0.5 + 3 × 1.0 mm <sup>2</sup>	452 – 16 × 0.5 + 3 × 1.0 mm <sup>2</sup>
3 Cable Length			
		3.0 m	0300
		5.0 m	0500
		10.0 m	1000
		15.0 m	1500
Technical Data			
Operating voltage		max. 125 V AC/DC	24 V DC
Total current		max. 7.5 A	
Protection		IP65, IP67, IP68	
Temperature range		-20...+90 °C, depending on cable quality	
Contact Layout			LED (green): Power / LED (yellow): (S1/S2)
LED display		–	
PIN 1		(+)	
PIN 2		(NC)/(S2)	
PIN 3		(-)	
PIN 4		(NO)/(S1)	
PIN 5		(Earth)	
Article No.			
The composition of your article number is explained on page 3.1.i		8 0 0 0 – – – – –	– – – – –
		1 Form	2 Cable Type
			3 Cable Length
Notes			

M12 Distribution Systems (Metal)

# M12 DISTRIBUTION SYSTEMS (METAL)

For sensors and actuators

- with molded homerun cable
- shielded



**MVP12 Metal**  
4-way



**MVP12 Metal**  
8-way



<b>1 Form</b>	<b>54515</b>	<b>58515</b>
	<b>without LED, 5-pole (for analog signals)</b>	<b>without LED, 5-pole (for analog signals)</b>
<b>Contact layout</b>		
<b>2 Cable Type</b>	<b>Jacket Color</b> – No./diameter of wires	
	<b>gray</b>	<b>gray</b>
PUR (UL/CSA), robots/C-tracks	<b>373</b> – 8 × 0.34 + 3 × 0.75 mm <sup>2</sup>	<b>401</b> – 16 × 0.34 + 3 × 0.75 mm <sup>2</sup>
<b>3 Cable Length</b>		
3.0 m	<b>0300</b>	
5.0 m	<b>0500</b>	
10.0 m	<b>1000</b>	
15.0 m	<b>1500</b>	
<b>Technical Data</b>		
Operating voltage	max. 125 V AC/DC	
Total current	max. 7.5 A	
Protection	IP65, IP67, IP68	
Temperature range	-20...+90 °C, depending on cable quality	
<b>Contact Layout</b>		
PIN 1	(+)	
PIN 2	(NC)/(S2)	
PIN 3	(-)	
PIN 4	(NO)/(S1)	
PIN 5	(Earth)	
Shield	via M12 thread	
<b>Article No.</b>		
The composition of your article number is explained on page 3.1.i	<b>8 0 0 0</b> - - - - -	- - - - -
	<b>1 Form</b>	<b>2 Cable Type</b>
		<b>3 Cable Length</b>
<b>Notes</b>		

M12 Distribution Systems (Metal)

# M12 DISTRIBUTION SYSTEMS (METAL)

For sensors and actuators

– with molded homerun cable

– shielded

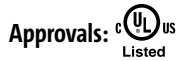

## MVP12 Metal

4-way  
for PNP signals 24 V DC



## MVP12 Metal

8-way  
for PNP signals 24 V DC



<b>1 Form</b>	<b>54513</b>	<b>58513</b>								
Type	PNP, 5-pole	PNP, 5-pole								
Contact layout	<p>for 2 signals per port</p>									
<b>2 Cable Type</b>	<b>Jacket Color</b> – No./diameter of wires									
PUR (UL/CSA), robots/C-tracks	gray 373 – 8 × 0.34 + 3 × 0.75 mm <sup>2</sup>	gray 401 – 16 × 0.34 + 3 × 0.75 mm <sup>2</sup>								
<b>3 Cable Length</b>										
3.0 m	0300									
5.0 m	0500									
10.0 m	1000									
15.0 m	1500									
<b>Technical Data</b>										
Operating voltage	24 V DC									
Total current	max. 7.5 A									
Protection	IP65, IP67, IP68									
Temperature range	-20...+90 °C, depending on cable quality									
<b>Contact Layout</b>										
LED display	LED (green): Power / LED (yellow): (S1/S2)									
PIN 1	(+) (N/C)/(S2)									
PIN 2	(-)									
PIN 3	(N/O)/(S1)									
PIN 4	(Earth)									
Shield	via M12 thread									
<b>Article No.</b>										
The composition of your article number is explained on page 3.1.i	<table border="1"> <tr> <td>8</td> <td>0</td> <td>0</td> <td>0</td> <td>-</td> <td>-</td> <td>-</td> <td>-</td> </tr> </table>		8	0	0	0	-	-	-	-
8	0	0	0	-	-	-	-			
	<b>1 Form</b>	<b>2 Cable Type</b>	<b>3 Cable Length</b>							
<b>Notes</b>										

M12 Distribution Systems (Metal)

# M12 DISTRIBUTION SYSTEMS (METAL)

For sensors and actuators

- M23 plug connection, 19-pole
- for unshielded or shielded use

Approvals:  Listed

## MVP12 Metal

4-way  
for PNP signals 24 V DC



## MVP12 Metal

8-way  
for PNP signals 24 V DC



### 1 Form

**54520**

**58520**

Type

PNP, 5-pole

PNP, 5-pole

Contact layout

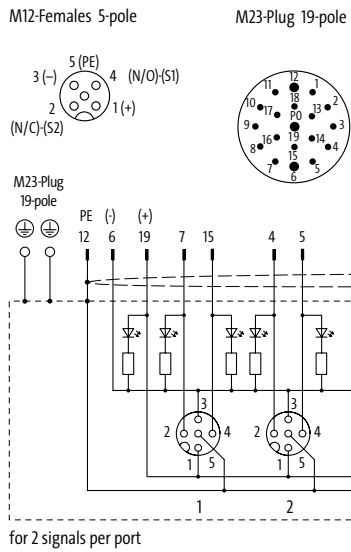

### Technical Data

Operating voltage	24 V DC
Operating current per contact	max. 4 A
Total current	max. 7.5 A
Protection	IP65, IP67, IP68
Housing	Zinc die casting, matte nickel plated
Temperature range	-25...+90 °C

### Contact Layout

LED display	LED (green): Power / LED (yellow): (S1/S2)
PIN 1	(+)
PIN 2	(NC)/(S2)
PIN 3	(-)
PIN 4	(NO)/(S1)
PIN 5	(Earth)
Shield	via M12 outer thread and M23 outer thread

### Article No.

The composition of your article number is explained on page 3.1.i

8 0 0 0

-

0 0 0

0 0 0 0

**1** Form

Notes

# M12 DISTRIBUTION SYSTEMS (METAL)

For sensors and actuators

- M23 plug connection, 19-pole
- for unshielded or shielded use

Approvals:  **UL**  
Listed

**MVP12 Metal**

4-way



**MVP12 Metal**

8-way

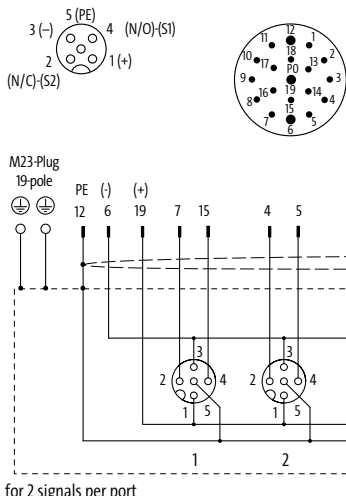

<b>1 Form</b>	<b>54522</b>	<b>58522</b>
Type	without LED, 5-pole (for analog signals)	without LED, 5-pole (for analog signals)
Contact layout	<p>M12-Females 5-pole      M23-Plug 19-pole</p>  <p>M23-Plug 19-pole PE (-) (+) 12 6 19 7 15 4 5</p> <p>for 2 signals per port</p>	
<b>Technical Data</b>		
Operating voltage	max. 125 V AC/DC	
Operating current per contact	max. 4 A	
Total current	max. 7.5 A	
Protection	IP65, IP67, IP68	
Housing	Zinc die casting, matte nickel plated	
Temperature range	-25...+80 °C	
<b>Contact Layout</b>		
PIN 1	(+)      1	
PIN 2	(NC)/(S2)      2	
PIN 3	(-)      3	
PIN 4	(NO)/(S1)      4	
PIN 5	(Earth)      5	
Shield	via M12 outer thread and M23 outer thread	
<b>Article No.</b>		
The composition of your article number is explained on page 3.1.i	<span style="border-bottom: 1px solid black; padding: 0 5px;">8</span> <span style="border-bottom: 1px solid black; padding: 0 5px;">0</span> <span style="border-bottom: 1px solid black; padding: 0 5px;">0</span> <span style="border-bottom: 1px solid black; padding: 0 5px;">0</span> - <span style="border-bottom: 1px solid black; padding: 0 5px;"> </span> <span style="border-bottom: 1px solid black; padding: 0 5px;"> </span> <span style="border-bottom: 1px solid black; padding: 0 5px;"> </span> <span style="border-bottom: 1px solid black; padding: 0 5px;"> </span> - <span style="border-bottom: 1px solid black; padding: 0 5px;">0</span> <span style="border-bottom: 1px solid black; padding: 0 5px;">0</span> <span style="border-bottom: 1px solid black; padding: 0 5px;">0</span> <span style="border-bottom: 1px solid black; padding: 0 5px;"> </span> <span style="border-bottom: 1px solid black; padding: 0 5px;"> </span> <span style="border-bottom: 1px solid black; padding: 0 5px;"> </span> <span style="border-bottom: 1px solid black; padding: 0 5px;"> </span>	
	<b>1 Form</b>	
<b>Notes</b>		

M12 Distribution Systems (Metal)

# M12 DISTRIBUTION SYSTEMS (METAL)

For harsh environments

– for unshielded or shielded use

## MVP12 Metal UNIVERSAL

with molded homerun cable

4-way



### 1 Form 54712

Type without LED, 5-pole (for analog signals)

#### Contact layout

M12-Females 5-pole

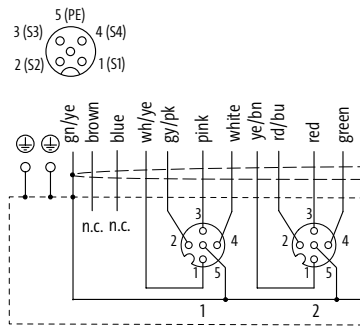

for 4 signals per port  
free arrangeable, PE bridged

### 2 Cable Type Jacket Color – No./diameter of wires

PUR (UL/CSA), robots/C-tracks  
401 – 16 × 0.34 + 3 × 0.75 mm<sup>2</sup>

### 3 Cable Length

3.0 m 0300  
5.0 m 0500  
10.0 m 1000  
15.0 m 1500

#### Technical Data

Operating voltage max. 42 V AC/DC  
Total current max. 10 A  
Protection IP65, IP67, IP68  
Temperature range -20...+90 °C, depending on cable quality

#### Contact Layout

PIN 1 (S1)  
PIN 2 (S2)  
PIN 3 (S3)  
PIN 4 (S4)  
PIN 5 (Earth)  
Shield via M12 thread

#### Article No.

The composition of your article number is explained on page 3.1.i

8 0 0 0

-

5 4 7 1 2

-

---

---

1 Form

2 Cable Type

3 Cable Length

Notes

# M12 DISTRIBUTION SYSTEMS (METAL)

For harsh environments  
– for unshielded or shielded use

**MVP12 Metal UNIVERSAL**  
M23 plug connection, 19-pole  
4-way















Approvals: UL  
Listed

<b>1 Form</b>	<b>54722</b>																																			
Type	without LED, 5-pole (for analog signals)																																			
Contact layout	<p>M12-Females 5-pole</p> <p>M23-Plug 19-pole</p> <p>M12-Females 5-pole</p> <p>M23-Plug 19-pole</p> <p>for 4 signals per port</p>																																			
<b>Technical Data</b>																																				
Operating voltage	max. 125 V AC/DC																																			
Operating current per contact	max. 4 A																																			
Total current	max. 7.5 A																																			
Protection	IP65, IP67, IP68																																			
Housing	Zinc die casting, matte nickel plated																																			
Locking of ports	Screw thread M12 × 1 mm																																			
Temperature range	-25...+90 °C																																			
<b>Contact Layout</b>																																				
PIN 1	(S1)																																			
PIN 2	(S2)																																			
PIN 3	(S3)																																			
PIN 4	(S4)																																			
PIN 5	(S5)/(Earth)																																			
<b>Article No.</b>																																				
The composition of your article number is explained on page 3.1.i	<table border="1"> <tr> <td><u>8</u></td> <td><u>0</u></td> <td><u>0</u></td> <td><u>0</u></td> <td>-</td> <td><u>5</u></td> <td><u>4</u></td> <td><u>7</u></td> <td><u>2</u></td> <td><u>2</u></td> <td>-</td> <td><u>0</u></td> <td><u>0</u></td> <td><u>0</u></td> <td><u>0</u></td> <td><u>0</u></td> <td><u>0</u></td> <td><u>0</u></td> </tr> <tr> <td colspan="17" style="text-align: center;"><b>1 Form</b></td> </tr> </table>	<u>8</u>	<u>0</u>	<u>0</u>	<u>0</u>	-	<u>5</u>	<u>4</u>	<u>7</u>	<u>2</u>	<u>2</u>	-	<u>0</u>	<u>0</u>	<u>0</u>	<u>0</u>	<u>0</u>	<u>0</u>	<u>0</u>	<b>1 Form</b>																
<u>8</u>	<u>0</u>	<u>0</u>	<u>0</u>	-	<u>5</u>	<u>4</u>	<u>7</u>	<u>2</u>	<u>2</u>	-	<u>0</u>	<u>0</u>	<u>0</u>	<u>0</u>	<u>0</u>	<u>0</u>	<u>0</u>																			
<b>1 Form</b>																																				
Notes																																				

M12 Distribution Systems (Metal)

## M12 DISTRIBUTION SYSTEMS (METAL)

Mounting accessories			Art-No.
	<b>Torque wrench set</b> M12 (0.6 Nm, SW13)	M12 data connector molded (standard)	7000-99102-000000
	<b>Torque wrench</b> M12 (0.6 Nm, SW13)	M12 data connector molded (standard)	7000-99109-000000
	<b>Torque wrench</b> M12 (0.6 Nm, SW14)	M12 data connector moulded (Xtreme)	7000-99108-000000
	<b>Torque wrench</b> M12 (0.6 Nm, SW17)	M12 field-wireable (IDC terminal)	7000-99094-000000
	<b>Torque wrench</b> M12 (0.6 Nm, SW18)	M12 field-wireable via (screw terminals)	7000-99103-000000
	<b>DIN-rail adapter</b> with fixing screws, plastic		27905
	<b>Earth connection set</b>		996064
	<b>V2A-base plate</b>	MVP12 Metal, 4-way	996065
		MVP12 Metal, 8-way	996066
	<b>Ground strap 4 mm<sup>2</sup></b> 100 mm for hole (M3)		4000-71001-041003
	<b>End fitting set M3</b>	Ground straps	4000-71003-0101403
Plug accessories			Art-No.
	<b>Torque wrench set</b> M12 (0.6 Nm, SW13)	M12 data connector molded (standard)	7000-99102-000000
	<b>Screw plug M12 × 1 mm</b> Metal, hex, 1 piece		996049



# M12 DISTRIBUTION SYSTEMS (METAL)

Plug accessories			Art-No.
	<b>Label plates</b> KES 20 × 8 (white)	(10 pieces/2 plates)	996067
	<b>Adapter M8/M12</b> 3-pole 4-pole	M12 Distribution Systems M12 Distribution Systems	7000-42201-000000 7000-42211-000000
Homerun cable accessories			Art-No.
	<b>Screw plug M23</b> Metal		55352
	<b>Cable rings (50 m), 5-pole, PUR (UL/CSA), halogen free</b> 8×0.5 + 3×1.0 mm <sup>2</sup> 16×0.5 + 3×1.0 mm <sup>2</sup> 16×0.34 + 5×0.75 mm <sup>2</sup>	4-way distribution boxes M12 8-way distribution boxes M12 8-way distribution boxes M12, potentially separated	8000-00000-4485000 8000-00000-4525000 8000-00000-4035000
	<b>Cable rings (50 m), 5-pole, PUR (UL/CSA), halogen free</b> 8×0.34 + 3×0.75 mm <sup>2</sup> 16×0.34 + 3×0.75 mm <sup>2</sup>	4-way distribution boxes M12, shielded 8-way distribution boxes M12, shielded	8000-00000-3735000 8000-00000-4015000

# M12 DISTRIBUTION SYSTEMS (METAL)

## M12 Distribution Systems Technical Data

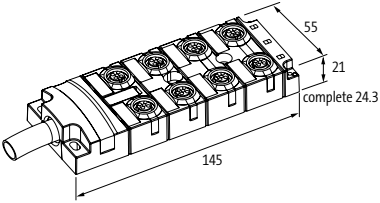
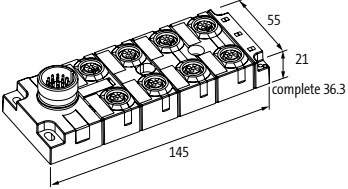
	Description	4-way	8-way
	<b>MVP Metal and MVP Metal UNIVERSAL</b> Molded homerun cable	95 mm	145 mm
	Description	4-way	8-way
	<b>MVP Metal and MVP Metal UNIVERSAL</b> M23 plug connection	95 mm	145 mm

# M12 DISTRIBUTION SYSTEMS PLASTIC

- Fully potted, sealed
- Highly resistant
- Application oriented

## PLUGGABLE CONNECTIONS FROM THE PROCESS TO THE CONTROL

- Quick installation with pre-wired and tested cables
- Easy to separate during transportation and simple when redesigning your system, rapid replacement of damaged cables
- Double assignment of M12 ports saves space
- Safety models for inputs and outputs according to EN ISO 13849-2
- Universal configuration – contacts designed 1:1

### Pluggable or pre-wired homerun cable

 <p><b>Exact12</b></p> <ul style="list-style-type: none"> <li>• 4-, 8-way</li> <li>• With LED for PNP or NPN signals</li> <li>• Without LED for voltages up to 125 V AC/DC</li> <li>• Analog signals</li> <li>• ATEX</li> </ul> <p><i>Page 4.13.1</i></p>	 <p><b>Exact12</b></p> <ul style="list-style-type: none"> <li>• 4-, 8-way</li> <li>• With pluggable 8- or 12-pole M12 connection</li> <li>• With pluggable 12- or 19-pole M23 connection</li> </ul> <p><i>Page 4.13.27</i></p>
 <p><b>Exact12 basic modules</b></p> <ul style="list-style-type: none"> <li>• 4-, 8-way</li> <li>• With LED for PNP or NPN signals</li> <li>• Without LED for voltages up to 125 V AC/DC</li> <li>• Analog signals</li> </ul> <p><i>Page 4.13.8</i></p>	 <p><b>Exact12/MVP12 connection caps</b></p> <ul style="list-style-type: none"> <li>• Field-wireable with screw or spring clamp terminals</li> <li>• With pre-wired homerun cable and screw plug terminals</li> </ul> <p><i>Page 4.13.14</i></p>
 <p><b>Exact12 set</b></p> <ul style="list-style-type: none"> <li>• 4-, 8-way</li> <li>• With pluggable cap and screw plug terminals or spring clamp terminals</li> </ul> <p><i>Page 4.13.17</i></p>	 <p><b>Exact12 with connection on the back</b></p> <ul style="list-style-type: none"> <li>• 8-way</li> <li>• With pluggable connection on the back</li> <li>• Potential separation optional</li> </ul> <p><i>Page 4.13.25</i></p>
 <p><b>Exact12 UNIVERSAL</b></p> <ul style="list-style-type: none"> <li>• 4-way</li> <li>• M12 pin 1, 2, 3, and 4 freely configurable</li> </ul> <p><i>Page 4.13.30</i></p>	 <p><b>Exact12 – safety distribution system</b></p> <ul style="list-style-type: none"> <li>• 8-way</li> <li>• Potential separation optional</li> </ul> <p><i>Page 4.13.31</i></p>

# M12 DISTRIBUTION SYSTEMS (PLASTIC)

For sensors and actuators

– with molded homerun cable

**Exact12**

4-way  
for PNP signals 24 V DC



**Exact12**

8-way  
for PNP signals 24 V DC



Approvals: UL<sub>us</sub>  
Listed

1 Form		84410	88410
Type	PNP, 4-pole		PNP, 4-pole
Contact layout	M12-Females 4-pole   for 1 signal per port		M12-Females 4-pole   for 1 signal per port
2 Cable Type		Jacket Color – No./diameter of wires	
		gray	gray
PUR/PVC		333 – 4 × 0.34 + 3 × 0.75 mm <sup>2</sup>	
PUR/PVC (UL/CSA), C-tracks			362 – 8 × 0.34 + 3 × 0.75 mm <sup>2</sup>
PUR (UL/CSA), robots/C-tracks			447 – 8 × 0.5 + 3 × 1.0 mm <sup>2</sup>
3 Cable Length			
3.0 m		0300	
5.0 m		0500	
10.0 m		1000	
15.0 m		1500	
Technical Data			
Operating voltage		24 V DC	
Total current		max. 8 A	
Protection		IP65/IP67	
Temperature range		-20...+70 °C, depending on cable quality	
Contact Layout			
LED display		LED (green): Power / LED (yellow): (S1)	
PIN 1		(+)	
PIN 3		(-)	
PIN 4		(NO)/(S1)	
PIN 5		(Earth)	
Article No.			
The composition of your article number is explained on page 3.1.i		<div style="display: flex; justify-content: space-around; align-items: center;"> <span style="border-bottom: 1px solid black; padding: 0 5px;">8</span> <span style="border-bottom: 1px solid black; padding: 0 5px;">0</span> <span style="border-bottom: 1px solid black; padding: 0 5px;">0</span> <span style="border-bottom: 1px solid black; padding: 0 5px;">0</span> <span style="font-size: 2em;">-</span> <span style="border-bottom: 1px solid black; padding: 0 5px;"> </span> <span style="font-size: 2em;">-</span> <span style="border-bottom: 1px solid black; padding: 0 5px;"> </span> <span style="border-bottom: 1px solid black; padding: 0 5px;"> </span> <span style="border-bottom: 1px solid black; padding: 0 5px;"> </span> </div>	
		<b>1</b> Form	<b>2</b> Cable Type
		<b>3</b> Cable Length	
Notes		Further cable lengths on request.	

# M12 DISTRIBUTION SYSTEMS (PLASTIC)

For sensors and actuators

– with molded homerun cable

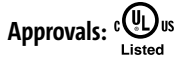

**Exact12**

4-way  
for NPN signals 24 V DC



**Exact12**

8-way  
for NPN signals 24 V DC



## 1 Form

**8 4 4 1 1**

**NPN, 4-pole**

Type  
Contact layout

M12-Females 4-pole

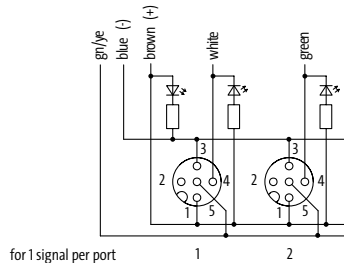
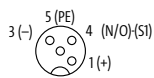

**8 8 4 1 1**

**NPN, 4-pole**

M12-Females 4-pole

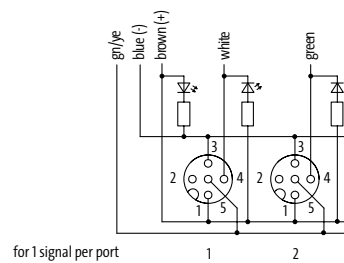
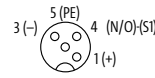

## 2 Cable Type

**Jacket Color** – No./diameter of wires

PUR/PVC  
PUR/PVC (UL/CSA), C-tracks  
PUR (UL/CSA), robots/C-tracks

**gray**  
**333** – 4 × 0.34 + 3 × 0.75 mm<sup>2</sup>  
**362** – 8 × 0.34 + 3 × 0.75 mm<sup>2</sup>  
**447** – 8 × 0.5 + 3 × 1.0 mm<sup>2</sup>

**gray**  
**362** – 8 × 0.34 + 3 × 0.75 mm<sup>2</sup>  
**447** – 8 × 0.5 + 3 × 1.0 mm<sup>2</sup>

## 3 Cable Length

5.0 m **0500**  
10.0 m **1000**

## Technical Data

Operating voltage	24 V DC	
Total current	max. 8 A	max. 10 A
Protection	IP65/IP67	
Temperature range	-20...+70 °C, depending on cable quality	

## Contact Layout

LED display	LED (green): Power / LED (yellow): (S1)
PIN 1	(+)
PIN 3	(-)
PIN 4	(NO)/(S1)
PIN 5	(Earth)

## Article No.

The composition of your article number is explained on page 3.1.i

**8 0 0 0** - - - - -

**1** Form

**2** Cable Type

**3** Cable Length

## Notes

Further cable lengths on request.

# M12 DISTRIBUTION SYSTEMS (PLASTIC)

For sensors and actuators

– with molded homerun cable

**Exact12**

4-way  
without LED



**Exact12**

8-way  
without LED

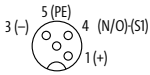
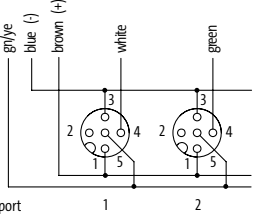
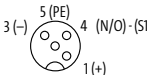
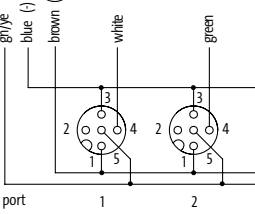

Approvals:  Listed

1 Form		84412	88412
Type		without LED, 4-pole	without LED, 4-pole
Contact layout		<p>M12-Females 4-pole</p>   <p>for 1 signal per port</p>	<p>M12-Females 4-pole</p>   <p>for 1 signal per port</p>
2 Cable Type		Jacket Color – No./diameter of wires	
		gray	gray
PUR/PVC		333 – 4 × 0.34 + 3 × 0.75 mm <sup>2</sup>	
PUR/PVC (UL/CSA), C-tracks			362 – 8 × 0.34 + 3 × 0.75 mm <sup>2</sup>
PUR (UL/CSA), robots/C-tracks			447 – 8 × 0.5 + 3 × 1.0 mm <sup>2</sup>
3 Cable Length			
5.0 m		0500	
10.0 m		1000	
Technical Data			
Operating voltage		125 V AC/DC	
Total current		max. 8 A	
Protection		IP65/IP67	
Temperature range		-20...+70 °C, depending on cable quality	
Contact Layout			
PIN 1		(+)	
PIN 3		(-)	
PIN 4		(NO)/(S1)	
PIN 5		(Earth)	
Article No.			
The composition of your article number is explained on page 3.1.i		<b>8 0 0 0</b> – _____ – _____	_____
		<b>1</b> Form	<b>2</b> Cable Type
			<b>3</b> Cable Length
Notes		Further cable lengths on request.	

# M12 DISTRIBUTION SYSTEMS (PLASTIC)

For sensors and actuators

– with molded homerun cable

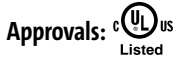

## Exact12

4-way  
for PNP signals 24 V DC



## Exact12

8-way  
for PNP signals 24 V DC



1 Form		84510	88510
Type		PNP, 5-pole	PNP, 5-pole
Contact layout		<p>M12-Females 5-pole</p> <p>for 2 signals per port</p>	<p>M12-Females 5-pole</p> <p>for 2 signals per port</p>
2 Cable Type		Jacket Color – No./diameter of wires	
		gray	gray
	PUR/PVC	363 – 8 × 0.34 + 3 × 0.75 mm <sup>2</sup>	452 – 16 × 0.5 + 3 × 1.0 mm <sup>2</sup>
	PUR (UL/CSA), robots/Ctracks	448 – 8 × 0.5 + 3 × 1.0 mm <sup>2</sup>	398 – 16 × 0.34 + 3 × 0.75 mm <sup>2</sup>
	PUR/PVC (UL/CSA), Ctracks		
3 Cable Length			
	3.0 m	0300	
	5.0 m	0500	
	10.0 m	1000	
	15.0 m	1500	
Technical Data			
	Operating voltage	24 V DC	
	Total current	max. 8 A	
	Protection	IP65/IP67	
	Temperature range	-20...+70 °C, depending on cable quality	
Contact Layout			
	LED display	LED (green): Power / LED (yellow): (S1) / LED (white): Signal (S2)	
	PIN 1	(+)	
	PIN 2	(NC)/(S2)	
	PIN 3	(-)	
	PIN 4	(NO)/(S1)	
	PIN 5	(Earth)	
Article No.			
The composition of your article number is explained on page 3.1.i		8 0 0 0	
		1 Form	2 Cable Type
			3 Cable Length
Notes		Further cable lengths on request.	

# M12 DISTRIBUTION SYSTEMS (PLASTIC)

For sensors and actuators

– with molded homerun cable

## Exact12

4-way  
for PNP signals 24 V DC  
ATEX Zone 2 and 22



## Exact12

8-way  
for PNP signals 24 V DC  
ATEX Zone 2 and 22

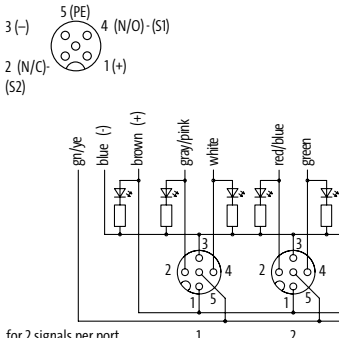
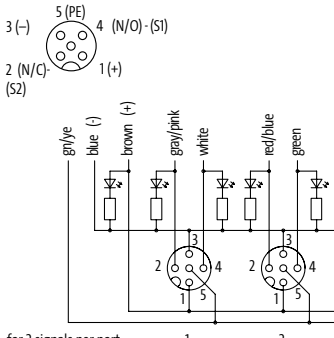

Approvals:  

1 Form		84510	88510
Type	PNP, 5-pole		PNP, 5-pole
Contact layout	M12-Females 5-pole 3 (-) 4 (N/O)-(S1) 2 (N/C)-(S2) 1 (+)  for 2 signals per port		M12-Females 5-pole 3 (-) 4 (N/O)-(S1) 2 (N/C)-(S2) 1 (+)  for 2 signals per port
2 Cable Type	Jacket Color – No./diameter of wires	gray	gray
		448 – 8 × 0.5 + 3 × 1.0 mm <sup>2</sup>	452 – 16 × 0.5 + 3 × 1.0 mm <sup>2</sup>
3 Cable Length			
		3.0 m	0300
		5.0 m	0500
		10.0 m	1000
		15.0 m	1500
Technical Data			
Operating voltage		24 V DC	
Total current		max. 8 A	
Protection		IP65/IP67	
Temperature range		-20...+70 °C, depending on cable quality	
Contact Layout			
LED display		LED (green): Power / LED (yellow): (S1) / LED (white): Signal (S2)	
PIN 1		(+)	
PIN 2		(NC)/(S2)	
PIN 3		(-)	
PIN 4		(NO)/(S1)	
PIN 5		(Earth)	
Article No.			
The composition of your article number is explained on page 3.1.i		<b>8 0 9 9</b> - - - - -	- - - - -
		<b>1</b> Form	<b>2</b> Cable Type
			<b>3</b> Cable Length
Notes		Further cable lengths on request.	



# M12 DISTRIBUTION SYSTEMS (PLASTIC)

For sensors and actuators

– with molded homerun cable

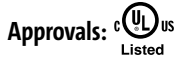

## Exact12

4-way  
for NPN signals 24 V DC



## Exact12

8-way  
for NPN signals 24 V DC



### 1 Form

### 84511

### 88511

Type  
Contact layout

NPN, 5-pole

NPN, 5-pole

M12-Females 5-pole

M12-Females 5-pole

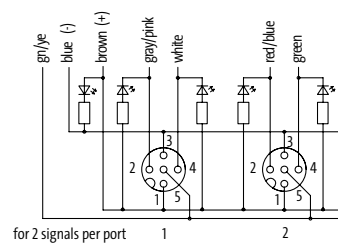
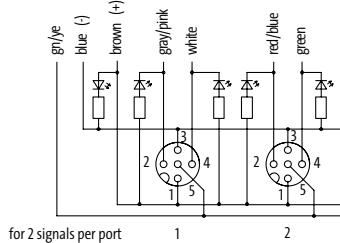
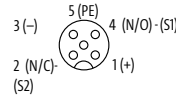
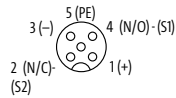

### 2 Cable Type

Jacket Color – No./diameter of wires

PUR/PVC  
PUR (UL/CSA), robots/C-tracks  
PUR/PVC (UL/CSA), C-tracks

gray  
363 – 8 × 0.34 + 3 × 0.75 mm<sup>2</sup>  
448 – 8 × 0.5 + 3 × 1.0 mm<sup>2</sup>

gray  
452 – 16 × 0.5 + 3 × 1.0 mm<sup>2</sup>  
398 – 16 × 0.34 + 3 × 0.75 mm<sup>2</sup>

### 3 Cable Length

5.0 m **0500**  
10.0 m **1000**

### Technical Data

Operating voltage 24 V DC  
Total current max. 8 A  
Protection IP65/IP67  
Temperature range -20...+70 °C, depending on cable quality

### Contact Layout

LED display LED (green): Power / LED (yellow): (S1) / LED (white): Signal (S2)  
PIN 1 (+)  
PIN 2 (NC)/(S2)  
PIN 3 (-)  
PIN 4 (NO)/(S1)  
PIN 5 (Earth)

### Article No.

The composition of your article number is explained on page 3.1.i

**8 0 0 0** - - - - -

**1** Form

**2** Cable Type

**3** Cable Length

### Notes

Further cable lengths on request.

# M12 DISTRIBUTION SYSTEMS (PLASTIC)

For sensors and actuators

– with molded homerun cable

**Exact12**

4-way  
without LED



**Exact12**

8-way  
without LED

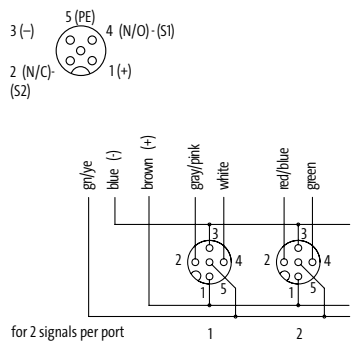
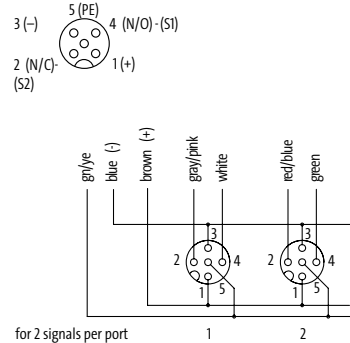

Approvals: 

1 Form		84512	88512
Type		without LED, 5-pole	without LED, 5-pole
Contact layout		<p>M12-Females 5-pole</p>  <p>for 2 signals per port</p>	<p>M12-Females 5-pole</p>  <p>for 2 signals per port</p>
2 Cable Type		<b>Jacket Color</b> – No./diameter of wires	
		<b>gray</b>	<b>gray</b>
PUR/PVC		<b>363</b> – 8 × 0.34 + 3 × 0.75 mm <sup>2</sup>	
PUR (UL/CSA), robots/C-tracks		<b>448</b> – 8 × 0.5 + 3 × 1.0 mm <sup>2</sup>	<b>452</b> – 16 × 0.5 + 3 × 1.0 mm <sup>2</sup>
PUR/PVC (UL/CSA), C-tracks			<b>398</b> – 16 × 0.34 + 3 × 0.75 mm <sup>2</sup>
3 Cable Length			
5.0 m		<b>0500</b>	
10.0 m		<b>1000</b>	
Technical Data			
Operating voltage		125 V AC/DC	
Total current		max. 8 A	
Protection		IP65/IP67	
Temperature range		-20...+70 °C, depending on cable quality	
Contact Layout			
PIN 1		(+)	
PIN 2		(NC)/(S2)	
PIN 3		(-)	
PIN 4		(NO)/(S1)	
PIN 5		(Earth)	
Article No.			
The composition of your article number is explained on page 3.1.i		<b>8 0 0 0</b> – _____ – _____	_____
		<b>1 Form</b>	<b>2 Cable Type</b>
			<b>3 Cable Length</b>
Notes		Further cable lengths on request.	

# M12 DISTRIBUTION SYSTEMS (PLASTIC)

For sensors and actuators

– Base modules



## Exact12

4-way  
for PNP signals 24 V DC



## Exact12

8-way  
for PNP signals 24 V DC



1 Form	84400	88400
<b>Type</b>	PNP, 4-pole	PNP, 4-pole
<b>Contact layout</b>	<p>M12-Females 4-pole</p> <p>for 1 signal per port</p>	<p>M12-Females 4-pole</p> <p>for 1 signal per port</p>
<b>Technical Data</b>		
Operating voltage	24 V DC	
Operating current per contact	max. 4 A	
Total current	max. 8 A	
Protection	IP65/IP67	
Housing	Plastic, flame retardant	
Temperature range	-20...+70 °C	
<b>Contact Layout</b>		
LED display	LED (green): Power / LED (yellow): (S1)	
PIN 1	(+)	
PIN 3	(-)	
PIN 4	(NO)/(S1)	
PIN 5	(Earth)	
<b>Article No.</b>		
The composition of your article number is explained on page 3.1.i	<div style="display: flex; justify-content: space-around; align-items: center;"> <span><u>8 0 0 0</u></span> <span>-</span> <span>_____</span> <span>-</span> <span><u>0 0 0</u></span> <span>  </span> <span><u>0 0 0 0</u></span> </div>	
<b>1 Form</b>		
<b>Notes</b>		

M12 Distribution Systems (Plastic)

# M12 DISTRIBUTION SYSTEMS (PLASTIC)

For sensors and actuators

– Base modules

**Exact12**

4-way  
for NPN signals 24 V DC





**Exact12**

8-way  
for NPN signals 24 V DC

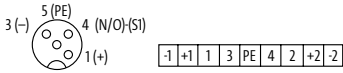
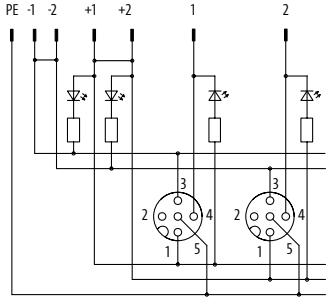
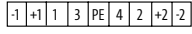

Approvals:  **UL**  
Listed

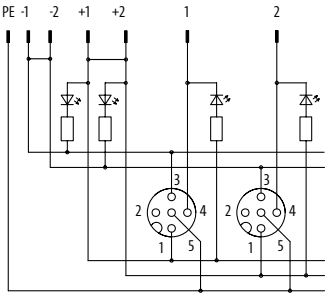
<b>1 Form</b>	<b>84401</b>	<b>88401</b>
	<b>NPN, 4-pole</b>	<b>NPN, 4-pole</b>
Type	M12-Females 4-pole	M12-Females 4-pole
Contact layout	  for 1 signal per port	   for 1 signal per port
<b>Technical Data</b>		
Operating voltage	24 V DC	
Operating current per contact	max. 4 A	
Total current	max. 8 A	
Protection	IP65/IP67	
Housing	Plastic, flame retardant	
Temperature range	-20...+70 °C	
<b>Contact Layout</b>		
LED display	LED (green): Power / LED (yellow): (S1)	
PIN 1	(+) / (S1)	
PIN 3	(-)	
PIN 4	(NO)/(S1)	
PIN 5	(Earth)	
<b>Article No.</b>		
The composition of your article number is explained on page 3.1.i	<div style="display: flex; justify-content: space-around; align-items: center;"> <span style="border: 1px solid black; padding: 2px 5px;"><b>8 0 0 0</b></span> <span>-</span> <span style="border: 1px solid black; padding: 2px 5px;"><b>0 0 0</b></span> <span>-</span> <span style="border: 1px solid black; padding: 2px 5px;"><b>0 0 0 0</b></span> </div>	
	<b>1 Form</b>	
<b>Notes</b>		

# M12 DISTRIBUTION SYSTEMS (PLASTIC)

For sensors and actuators

– Base modules

Approvals:  Listed

## Exact12

4-way  
without LED



## Exact12

8-way  
without LED



### 1 Form

Type  
Contact layout

### 84402

without LED, 4-pole

M12 Females 4-pole

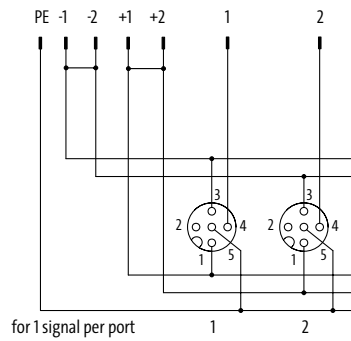
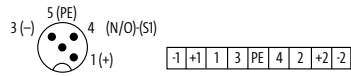

### 88402

without LED, 4-pole

M12-Females 4-pole

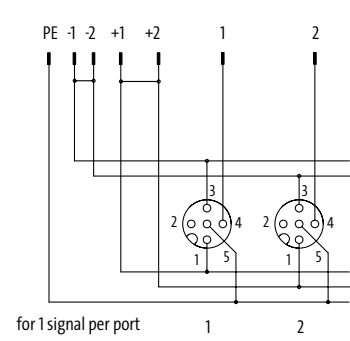
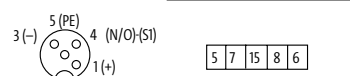

### Technical Data

Operating voltage	125 V AC/DC
Operating current per contact	max. 4 A
Total current	max. 8 A
Protection	IP65/IP67
Housing	Plastic, flame retardant
Temperature range	-20...+70 °C

### Contact Layout

PIN 1	(+)
PIN 3	(-)
PIN 4	(NO)/(S1)
PIN 5	(Earth)

### Article No.

The composition of your article number is explained on page 3.1.i

8 0 0 0

- - - - -

0 0 0

0 0 0 0

**1** Form

Notes

# M12 DISTRIBUTION SYSTEMS (PLASTIC)

For sensors and actuators

– Base modules

## Exact12

4-way  
for PNP signals 24 V DC



## Exact12

8-way  
for PNP signals 24 V DC



Approvals: UL US  
Listed

1 Form	84500	88500	
<b>Type</b>	<b>PNP, 5-pole</b>	<b>PNP, 5-pole</b>	
<b>Contact layout</b>	<p>M12-Females 5-pole</p> <p>for 2 signals per port</p>	<p>M12-Females 5-pole</p> <p>for 2 signals per port</p>	
<b>Technical Data</b>			
Operating voltage	24 V DC		
Operating current per contact	max. 4 A		
Total current	max. 8 A		
Protection	IP65/IP67		
Housing	Plastic, flame retardant		
Temperature range	-20...+70 °C		
<b>Contact Layout</b>			
LED display	LED (green): Power / LED (yellow): (S1) / LED (white): Signal (S2)		
PIN 1	(+) / (S1)		
PIN 2	(NC)/(S2)		
PIN 3	(-) / (S1)		
PIN 4	(NO)/(S1)		
PIN 5	(Earth)		
<b>Article No.</b>			
The composition of your article number is explained on page 3.1.i	<b>8 0 0 0</b>	<b>0 0 0</b>	<b>0 0 0 0</b>
	<b>1 Form</b>		
<b>Notes</b>			

# M12 DISTRIBUTION SYSTEMS (PLASTIC)

For sensors and actuators

– Base modules



## Exact12

4-way  
for NPN signals 24 V DC



## Exact12

8-way  
for NPN signals 24 V DC



### 1 Form

Type  
Contact layout

### 84501

NPN, 5-pole

M12-Females 5-pole

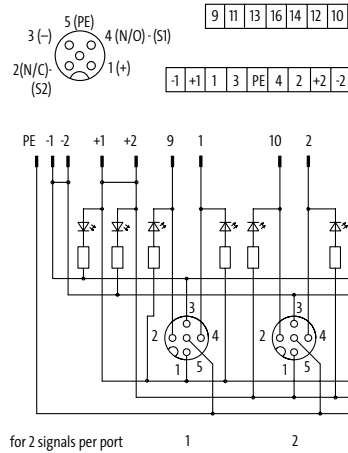

### 88501

NPN, 5-pole

M12-Females 5-pole

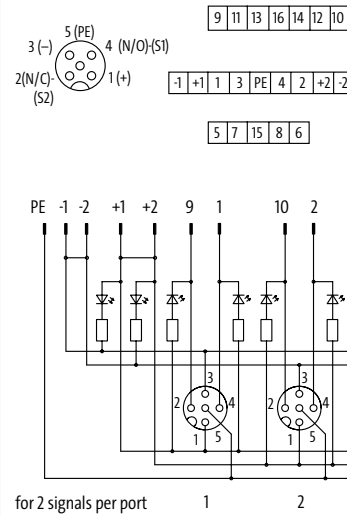

### Technical Data

Operating voltage	24 V DC
Operating current per contact	max. 4 A
Total current	max. 8 A
Protection	IP65/IP67
Housing	Plastic, flame retardant
Temperature range	-20...+70 °C

### Contact Layout

LED display	LED (green): Power / LED (yellow): (S1) / LED (white): Signal (S2)
PIN 1	(+)
PIN 2	(NC)/(S2)
PIN 3	(-)
PIN 4	(NO)/(S1)
PIN 5	(Earth)

### Article No.

The composition of your article number is explained on page 3.1.i

8 0 0 0

-

0 0 0

0 0 0 0

**1** Form

Notes

# M12 DISTRIBUTION SYSTEMS (PLASTIC)

For sensors and actuators

– Base modules



**Exact12**

4-way  
without LED



**Exact12**

8-way  
without LED



## 1 Form

<b>Type</b>	<b>84502</b> without LED, 5-pole	<b>88502</b> without LED, 5-pole
<b>Contact layout</b>	<p>M12-Females 5-pole</p> <p>for 2 signals per port</p>	<p>M12-Females 5-pole</p> <p>for 2 signals per port</p>

## Technical Data

Operating voltage	125 V AC/DC
Operating current per contact	max. 4 A
Total current	max. 8 A
Protection	IP65/IP67
Housing	Plastic, flame retardant
Temperature range	-20...+70 °C

## Contact Layout

PIN 1	(+)
PIN 2	(NC)/(S2)
PIN 3	(-)
PIN 4	(NO)/(S1)
PIN 5	(Earth)

## Article No.

The composition of your article number is explained on page 3.1.i	<b>8 0 0 0</b>	-	-	<b>0 0 0</b>	<b>0 0 0 0</b>
	<b>1</b>		<b>Form</b>		

## Notes



# M12 DISTRIBUTION SYSTEMS (PLASTIC)

For sensors and actuators

– Connection cap with homerun cable

## Exact12

for 4-way distribution boxes



1 Form	84459	84559	84659
Type	4-pole Screw plug-in terminals	5-pole Screw plug-in terminals	5-pole Screw plug-in terminals with potential separation
Contact layout	M12-Females 4-pole   for 1 signal per port	M12-Females 5-pole  Exact12   for 2 signals per port	
2 Cable Type	Jacket Color – No./diameter of wires		
	gray 333 – 4 × 0.34 + 3 × 0.75 mm <sup>2</sup>	gray 363 – 8 × 0.34 + 3 × 0.75 mm <sup>2</sup>	gray 374 – 8 × 0.34 + 5 × 0.75 mm <sup>2</sup>
	PUR/PVC PUR (UL/CSA), robots/Ctracks	448 – 8 × 0.5 + 3 × 1.0 mm <sup>2</sup>	
3 Cable Length			
	3.0 m	0300	
	5.0 m	0500	
	10.0 m	1000	
	15.0 m	1500	
	20.0 m	2000	
	25.0 m	2500	
	30.0 m	3000	
Technical Data			
Total current	max. 8 A		
Temperature range	-20...+80 °C, depending on cable quality		
Article No.			
The composition of your article number is explained on page 3.1.i	<div style="display: flex; justify-content: space-between; align-items: center;"> <span><u>8</u> <u>0</u> <u>0</u> <u>0</u></span> <span>–</span> <span>–</span> <span>–</span> </div>		
	<b>1</b> Form	<b>2</b> Cable Type	<b>3</b> Cable Length
Notes			

M12 Distribution Systems (Plastic)

# M12 DISTRIBUTION SYSTEMS (PLASTIC)

For sensors and actuators

– Connection cap with homerun cable

**Exact12**  
for 8-way distribution boxes



1 Form	88459	88559	88659
Type	4-pole Screw plug-in terminals	5-pole Screw plug-in terminals	5-pole Screw plug-in terminals with potential separation
Contact layout	<p>M12 Females 4-pole</p> <p>for 1 signal per port</p>	<p>M12-Females 5-pole</p> <p>for 2 signals per port</p>	
2 Cable Type	Jacket Color – No./diameter of wires		
	gray	gray	gray
PUR/PVC			404 – 16 × 0.34 + 5 × 0.75 mm <sup>2</sup>
PUR/PVC (UL/CSA), C-tracks	362 – 8 × 0.34 + 3 × 0.75 mm <sup>2</sup>	398 – 16 × 0.34 + 3 × 0.75 mm <sup>2</sup>	
PUR (UL/CSA), robots/C-tracks	447 – 8 × 0.5 + 3 × 1.0 mm <sup>2</sup>	452 – 16 × 0.5 + 3 × 1.0 mm <sup>2</sup>	
3 Cable Length			
3.0 m	0300		
5.0 m	0500		
10.0 m	1000		
15.0 m	1500		
20.0 m	2000		
25.0 m	2500		
30.0 m	3000		
Technical Data			
Total current	max. 8 A		
Temperature range	-20...+80 °C, depending on cable quality		
Article No.			
The composition of your article number is explained on page 3.1.i	<div style="display: flex; justify-content: space-between; align-items: center;"> <span><b>8 0 0 0</b></span> <span>–</span> <span>–</span> <span>–</span> <span>–</span> </div>		
	<b>1</b> Form	<b>2</b> Cable Type	<b>3</b> Cable Length
Notes			



# M12 DISTRIBUTION SYSTEMS (PLASTIC)

For sensors and actuators

– Sets (basic module and cap)

– Field-wireable

Approvals: UL<sub>us</sub> Listed

Exact12

4-way



1 Form	84440	84450	84451
<b>Type</b>	PNP, 4-pole Spring clamp plug-in terminals	PNP, 4-pole Screw plug-in terminals	NPN, 4-pole Screw plug-in terminals
<b>Contact layout</b>	M12-Females 4-pole 		M12-Females 4-pole 
<b>Technical Data</b>	Operating voltage: 24 V DC Operating current per contact: max. 4 A Total current: max. 8 A Connection: Spring clamp plug-in terminals: max. 1.5 mm <sup>2</sup> (AWG 16) / Screw plug-in terminals: max. 1.5 mm <sup>2</sup> (AWG 16) Protection: IP65/IP67 Housing: Plastic, flame retardant Temperature range: -20...+70 °C		
<b>Contact Layout</b>	LED display: LED (green): Power / LED (yellow): (S1) PIN 1: (+) PIN 3: (-) PIN 4: (NO)/(S1) PIN 5: (Earth)		
<b>Article No.</b>			
The composition of your article number is explained on page 3.1.i	<div style="display: flex; justify-content: space-around; align-items: center;"> <span style="border-bottom: 1px solid black; padding: 0 5px;">8</span> <span style="border-bottom: 1px solid black; padding: 0 5px;">0</span> <span style="border-bottom: 1px solid black; padding: 0 5px;">0</span> <span style="border-bottom: 1px solid black; padding: 0 5px;">0</span> <span style="font-size: 2em;">-</span> <span style="border-bottom: 1px solid black; padding: 0 5px;"> </span> <span style="border-bottom: 1px solid black; padding: 0 5px;"> </span> <span style="border-bottom: 1px solid black; padding: 0 5px;"> </span> <span style="border-bottom: 1px solid black; padding: 0 5px;"> </span> <span style="border-bottom: 1px solid black; padding: 0 5px;"> </span> <span style="font-size: 2em;">-</span> <span style="border-bottom: 1px solid black; padding: 0 5px;">0</span> <span style="border-bottom: 1px solid black; padding: 0 5px;">0</span> <span style="border-bottom: 1px solid black; padding: 0 5px;">0</span> <span style="border-bottom: 1px solid black; padding: 0 5px;">0</span> </div>		
	<b>1 Form</b>		
<b>Notes</b>			

# M12 DISTRIBUTION SYSTEMS (PLASTIC)

For sensors and actuators

– Sets (basic module and cap)

– Field-wireable

**Exact12**

4-way



## 1 Form

**8 4 4 5 2**

Type **without LED, 4-pole**  
Screw plug-in terminals

Contact layout M12-Females 4-pole

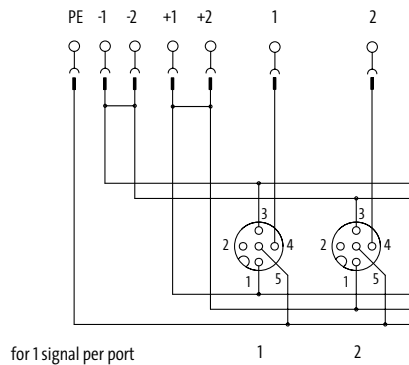

## Technical Data

Operating voltage	125 V AC/DC
Operating current per contact	max. 4 A
Total current	max. 8 A
Connection	Screw plug-in terminals: max. 1.5 mm <sup>2</sup> (AWG 16)
Protection	IP65/IP67
Housing	Plastic, flame retardant
Temperature range	-20...+70 °C

## Contact Layout

PIN 1	(+)
PIN 3	(-)
PIN 4	(NO)/(S1)
PIN 5	(Earth)

## Article No.

The composition of your article number is explained on page 3.1.i

8 0 0 0 - 8 4 4 5 2 - 0 0 0 0 0 0 0

**1** Form

Notes

# M12 DISTRIBUTION SYSTEMS (PLASTIC)

For sensors and actuators

– Sets (basic module and cap)

– Field-wireable



**Exact12**

4-way



1 Form	84540	84550
--------	-------	-------

Type	PNP, 5-pole Spring clamp plug-in terminals	PNP, 5-pole Screw plug-in terminals
------	---	--

Contact layout	<p>M12-Females 5-pole</p> <p>for 2 signals per port</p>	
----------------	---	--

### Technical Data

Operating voltage	24 V DC	
Operating current per contact	max. 4 A	
Total current	max. 8 A	
Connection	Spring clamp plug-in terminals: max. 1.5 mm <sup>2</sup> (AWG 16)	Screw plug-in terminals: max. 1.5 mm <sup>2</sup> (AWG 16)
Protection	IP65/IP67	
Housing	Plastic, flame retardant	
Temperature range	-20...+70 °C	

### Contact Layout

LED display	LED (green): Power / LED (yellow): (S1) / LED (white): Signal (S2)
PIN 1	(+)
PIN 2	(NC)/(S2)
PIN 3	(-)
PIN 4	(NO)/(S1)
PIN 5	(Earth)

### Article No.

The composition of your article number is explained on page 3.1.i	8 0 0 0 - - - - - 0 0 0 0 0 0 0 0
	<b>1 Form</b>

Notes

# M12 DISTRIBUTION SYSTEMS (PLASTIC)

For sensors and actuators

– Sets (basic module and cap)

– Field-wireable

**Exact12**

4-way



1 Form	84551	84552
<b>Approvals</b>	cULus	
<b>Type</b>	NPN, 5-pole	without LED, 5-pole
<b>Contact layout</b>	<p>M12-Females 5-pole</p> <p>9 11 13 16 14 12 10</p> <p>-1 +1 1 3 PE 4 2 +2 -2</p> <p>for 2 signals per port</p> <p>1 2</p>	<p>M12-Females 5-pole</p> <p>9 11 13 16 14 12 10</p> <p>-1 +1 1 3 PE 4 2 +2 -2</p> <p>for 2 signals per port</p> <p>1 2</p>
<b>Technical Data</b>		
Operating voltage	24 V DC	125 V AC/DC
Operating current per contact	max. 4 A	
Total current	max. 8 A	
Connection	Screw plug-in terminals: max. 1.5 mm <sup>2</sup> (AWG 16)	
Protection	IP65/IP67	
Housing	Plastic, flame retardant	
Temperature range	-20...+70 °C	
<b>Contact Layout</b>		
LED display	LED (green): Power / LED (yellow): (S1) / LED (white): Signal (S2)	–
PIN 1	(+)	
PIN 2	(NC)/(S2)	
PIN 3	(-)	
PIN 4	(NO)/(S1)	
PIN 5	(Earth)	
<b>Article No.</b>		
The composition of your article number is explained on page 3.1.i	<span style="border-bottom: 1px solid black; padding: 0 5px;">8</span> <span style="border-bottom: 1px solid black; padding: 0 5px;">0</span> <span style="border-bottom: 1px solid black; padding: 0 5px;">0</span> <span style="border-bottom: 1px solid black; padding: 0 5px;">0</span> <span style="font-size: 1.5em; vertical-align: middle;">-</span> <span style="border-bottom: 1px solid black; padding: 0 5px;"> </span> <span style="border-bottom: 1px solid black; padding: 0 5px;"> </span> <span style="border-bottom: 1px solid black; padding: 0 5px;"> </span> <span style="border-bottom: 1px solid black; padding: 0 5px;"> </span> <span style="font-size: 1.5em; vertical-align: middle;">-</span> <span style="border-bottom: 1px solid black; padding: 0 5px;"> </span> <span style="border-bottom: 1px solid black; padding: 0 5px;"> </span> <span style="border-bottom: 1px solid black; padding: 0 5px;"> </span> <span style="border-bottom: 1px solid black; padding: 0 5px;"> </span> <span style="border-bottom: 1px solid black; padding: 0 5px;">0</span> <span style="border-bottom: 1px solid black; padding: 0 5px;">0</span> <span style="border-bottom: 1px solid black; padding: 0 5px;">0</span> <span style="border-bottom: 1px solid black; padding: 0 5px;">0</span>	<span style="border-bottom: 1px solid black; padding: 0 5px;">0</span> <span style="border-bottom: 1px solid black; padding: 0 5px;">0</span> <span style="border-bottom: 1px solid black; padding: 0 5px;">0</span> <span style="border-bottom: 1px solid black; padding: 0 5px;">0</span>
	<b>1</b> Form	
<b>Notes</b>		

M12 Distribution Systems (Plastic)

# M12 DISTRIBUTION SYSTEMS (PLASTIC)

For sensors and actuators

- Sets (basic module and cap)
- Field-wireable

Approvals:  Listed

**Exact12**  
8-way

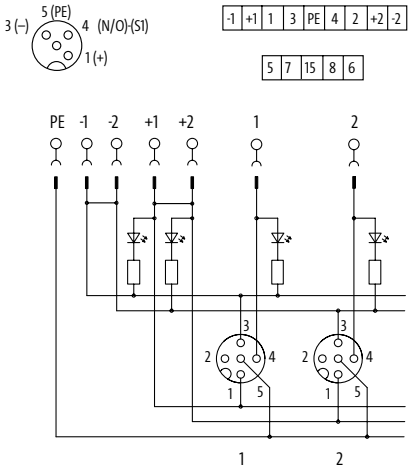

1 Form	<b>88440</b>	<b>88450</b>	
Type	PNP, 4-pole Spring clamp plug-in terminals	PNP, 4-pole Screw plug-in terminals	
Contact layout	<p>M12-Females 4-pole</p>  <p>for 1 signal per port</p>		
Technical Data			
Operating voltage	24 V DC		
Operating current per contact	max. 4 A		
Total current	max. 8 A		
Connection	Spring clamp plug-in terminals: max. 1.5 mm <sup>2</sup> (AWG 16)	Screw plug-in terminals: max. 1.5 mm <sup>2</sup> (AWG 16)	
Protection	IP65/IP67		
Housing	Plastic, flame retardant		
Temperature range	-20...+70 °C		
Contact Layout			
LED display	LED (green): Power / LED (yellow): (S1)		
PIN 1	(+) (S1)		
PIN 3	(-)		
PIN 4	(NO)/(S1)		
PIN 5	(Earth)		
Article No.			
The composition of your article number is explained on page 3.1.i	<b>8 0 0 0</b>	<b>0 0 0</b>	<b>0 0 0 0</b>
	<b>1 Form</b>		
Notes			



# M12 DISTRIBUTION SYSTEMS (PLASTIC)

For sensors and actuators

– Sets (basic module and cap)

– Field-wireable

**Exact12**

8-way



<b>1 Form</b>	<b>88451</b>	<b>88452</b>
---------------	--------------	--------------

<b>Approvals</b>	cULus	
<b>Type</b>	NPN, 4-pole	without LED, 4-pole
<b>Contact layout</b>	Screw plug-in terminals	Screw plug-in terminals

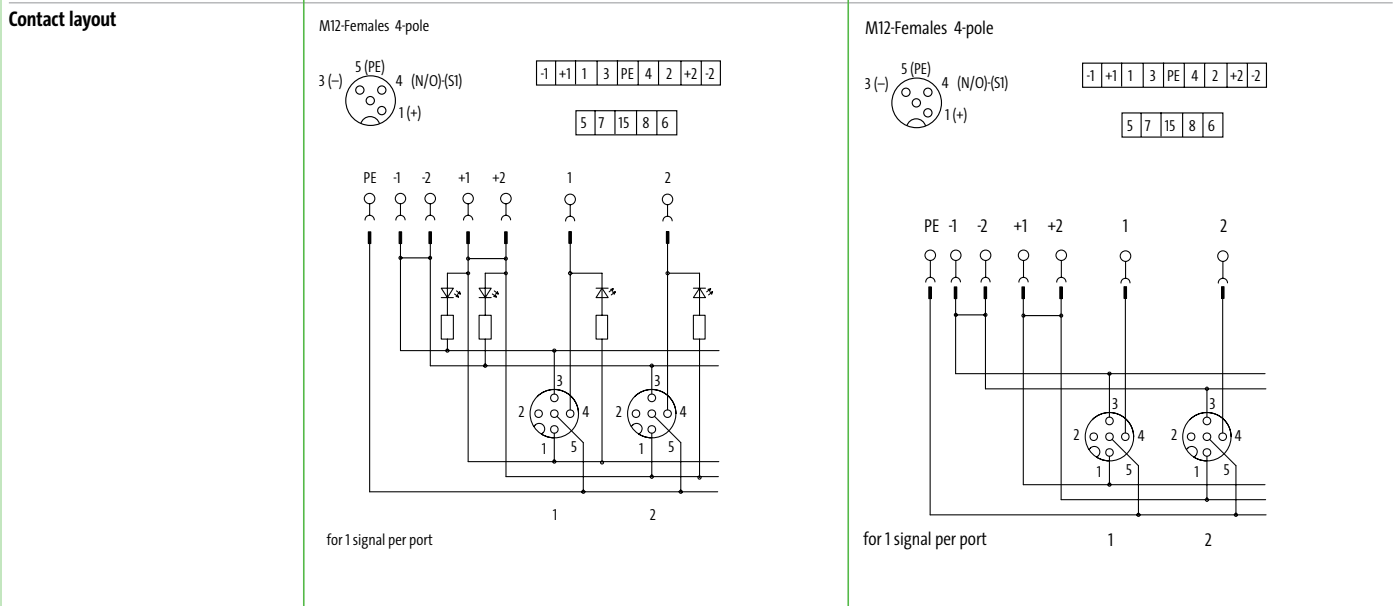

<b>Technical Data</b>		
-----------------------	--	--

Operating voltage	24 V DC	125 V AC/DC
Operating current per contact	max. 4 A	
Total current	max. 8 A	
Connection	Screw plug-in terminals: max. 1.5 mm <sup>2</sup> (AWG 16)	
Protection	IP65/IP67	
Housing	Plastic, flame retardant	
Temperature range	-20...+70 °C	

<b>Contact Layout</b>		
-----------------------	--	--

LED display	LED (green): Power / LED (yellow): (S1)	–
PIN 1	(+)	
PIN 3	(-)	
PIN 4	(NO)/(S1)	
PIN 5	(Earth)	

<b>Article No.</b>		
--------------------	--	--

The composition of your article number is explained on page 3.1.i	<b>8 0 0 0</b>	-	-	<b>0 0 0</b>	-	<b>0 0 0 0</b>
---	----------------	---	---	--------------	---	----------------

**1 Form**

Notes

# M12 DISTRIBUTION SYSTEMS (PLASTIC)

For sensors and actuators

– Sets (basic module and cap)

– Field-wireable

Approvals:  Listed

**Exact12**

8-way

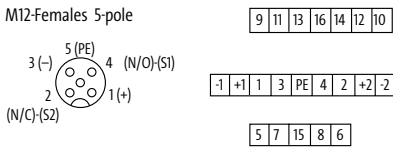
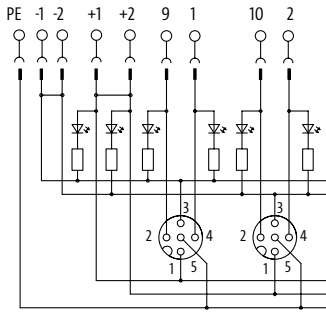

1 Form	88540	88550	
Type	PNP, 5-pole Spring clamp plug-in terminals	PNP, 5-pole Screw plug-in terminals	
Contact layout	<p>M12-Females 5-pole</p>  <p>3 (-) 5 (PE) 4 (N/O)/(S1) 1 (+) 2 (N/C)/(S2)</p>  <p>for 2 signals per port</p>		
<b>Technical Data</b>			
Operating voltage	24 V DC		
Operating current per contact	max. 4 A		
Total current	max. 8 A		
Connection	Spring clamp plug-in terminals: max. 1.5 mm <sup>2</sup> (AWG 16)	Screw plug-in terminals: max. 1.5 mm <sup>2</sup> (AWG 16)	
Protection	IP65/IP67		
Housing	Plastic, flame retardant		
Temperature range	-20...+70 °C		
<b>Contact Layout</b>			
LED display	LED (green): Power / LED (yellow): (S1) / LED (white): Signal (S2)		
PIN 1	(+) (S1)		
PIN 2	(NC)/(S2)		
PIN 3	(-) (S2)		
PIN 4	(NO)/(S1)		
PIN 5	(Earth)		
<b>Article No.</b>			
The composition of your article number is explained on page 3.1.i	<b>8 0 0 0</b>	<b>0 0 0</b>	<b>0 0 0 0</b>
	<b>1 Form</b>		
Notes			

# M12 DISTRIBUTION SYSTEMS (PLASTIC)

For sensors and actuators

– Sets (basic module and cap)

– Field-wireable

Exact12

8-way



<b>1 Form</b>	<b>88551</b>	<b>88552</b>
	<b>Approvals</b>	cULus
<b>Type</b>	<b>NPN, 5-pole</b>	<b>without LED, 5-pole</b>
<b>Contact layout</b>	<p>M12 Females 5-pole</p> <p>for 2 signals per port</p>	<p>M12 Females 5-pole</p> <p>for 2 signals per port</p>
<b>Technical Data</b>		
Operating voltage	24 V DC	125 V AC/DC
Operating current per contact	max. 4 A	
Total current	max. 8 A	
Connection	Screw plug-in terminals: max. 1.5 mm <sup>2</sup> (AWG 16)	
Protection	IP65/IP67	
Housing	Plastic, flame retardant	
Temperature range	-20...+70 °C	
<b>Contact Layout</b>		
LED display	LED (green): Power / LED (yellow): (S1) / LED (white): Signal (S2)	–
PIN 1	(+)	
PIN 2	(NC)/(S2)	
PIN 3	(-)	
PIN 4	(NO)/(S1)	
PIN 5	(Earth)	
<b>Article No.</b>		
The composition of your article number is explained on page 3.1.i	<b>8 0 0 0</b> – – – – – <b>0 0 0</b> <b>0 0 0 0</b>	
	<b>1 Form</b>	
<b>Notes</b>		

M12 Distribution Systems (Plastic)

# M12 DISTRIBUTION SYSTEMS (PLASTIC)

For sensors and actuators

– Rear connection

Approvals:  **UL** US  
Listed

Exact12



Exact12

with potential separation

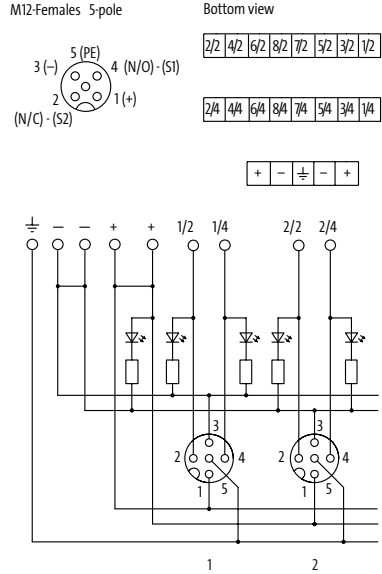
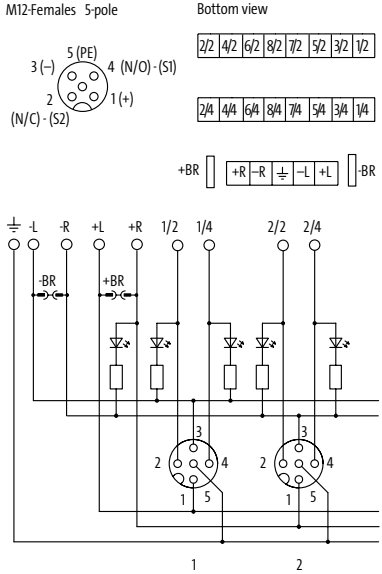

1 Form	88580	88680
Type	PNP, 5-pole Spring clamp terminals	PNP, 5-pole Spring clamp terminals
Contact layout	<p>M12-Females 5-pole Bottom view</p>  <p>for 2 signals per port</p>	<p>M12-Females 5-pole Bottom view</p>  <p>for 2 signals per port</p>
<b>Technical Data</b>		
Operating voltage	24 V DC	
Operating current per contact	max. 4 A	
Total current	max. 2 × 8 A	
Protection	IP65/IP67	
Housing	Plastic, flame retardant	
Temperature range	-20...+70 °C	
<b>Contact Layout</b>		
LED display	LED (green): Power / LED (yellow): (S1) / LED (white): Signal (S2)	
PIN 1	(+) / (NC)/(S2)	
PIN 2	(-)	
PIN 3	(NO)/(S1)	
PIN 4	(Earth)	
<b>Article No.</b>		
The composition of your article number is explained on page 3.1.i	<div style="display: flex; justify-content: space-around; align-items: center;"> <span style="border: 1px solid black; padding: 2px 5px;">8</span> <span style="border: 1px solid black; padding: 2px 5px;">0</span> <span style="border: 1px solid black; padding: 2px 5px;">0</span> <span style="border: 1px solid black; padding: 2px 5px;">0</span> <span style="font-size: 2em;">-</span> <span style="border: 1px solid black; padding: 2px 5px;">0</span> <span style="border: 1px solid black; padding: 2px 5px;">0</span> <span style="border: 1px solid black; padding: 2px 5px;">0</span> <span style="font-size: 2em;">-</span> <span style="border: 1px solid black; padding: 2px 5px;">0</span> <span style="border: 1px solid black; padding: 2px 5px;">0</span> <span style="border: 1px solid black; padding: 2px 5px;">0</span> <span style="border: 1px solid black; padding: 2px 5px;">0</span> </div>	
	1 Form	
Notes		

# M12 DISTRIBUTION SYSTEMS (PLASTIC)

For sensors and actuators

**Exact12**

Pluggable rear connection



**Exact12**

Pluggable rear connection  
with potential separation



Approvals: UL US  
Listed

1 Form	88590	88690
Type	PNP, 5-pole Spring clamp plug-in terminals	PNP, 5-pole Spring clamp plug-in terminals
Contact layout	<p>M12-Females 5-pole Bottom view</p> <p>for 2 signals per port</p>	<p>M12-Females 5-pole Bottom view</p> <p>for 2 signals per port</p>
<b>Technical Data</b>		
Operating voltage	24 V DC	
Operating current per contact	max. 4 A	
Total current	max. 2 × 8 A	
Protection	IP65/IP67	
Housing	Plastic, flame retardant	
Temperature range	-20...+70 °C	
<b>Contact Layout</b>		
LED display	LED (green): Power / LED (yellow): (S1) / LED (white): Signal (S2)	
PIN 1	(+) / (NC)/(S2)	
PIN 2	(-) / (NO)/(S1)	
PIN 3	(Earth)	
<b>Article No.</b>		
The composition of your article number is explained on page 3.1.i	<span style="font-size: 1.2em; font-weight: bold;">8 0 0 0</span> - <span style="font-size: 1.2em; font-weight: bold;">0 0 0</span> - <span style="font-size: 1.2em; font-weight: bold;">0 0 0 0</span>	
	<b>1 Form</b>	
<b>Notes</b>		

# M12 DISTRIBUTION SYSTEMS (PLASTIC)

For sensors and actuators

– M12 plug connection

**Exact12**

4-way



**Exact12**

8-way



**Exact12**

4-way



Approvals: **UL** <sup>us</sup>  
Listed

1 Form	84470	88460	84560
<b>Type</b>	5-, 4-pole M12 plug connection, 8-pole	5-, 4-pole M12 plug connection, 12-pole	5-pole M12 plug connection, 12-pole
<b>Contact layout</b>	<p>M12-Females</p> <p>5-pole 4-pole</p> <p>2 signals 1 signal</p> <p>M12-Plug</p> <p>8-pole</p> <p>M12-Plug 8-pole (-) (+) 7 5 1, 2, 6, 8 3+4</p> <p>1+2 3+4</p>	<p>M12-Females</p> <p>5-pole 4-pole</p> <p>2 signals 1 signal</p> <p>M12-Plug</p> <p>12-pole</p> <p>M12-Plug 12-pole (-) (+) 2 1 3, 4, 11, 12 5...10</p> <p>1+2 3...8</p>	<p>M12-Females</p> <p>5-pole</p> <p>M12-Plug</p> <p>12-pole</p> <p>M12-Plug 12-pole (-) (+) 2 1 5 3 9 4</p> <p>for 2 signals per port 1 2</p>
<b>Technical Data</b>			
Operating voltage	24 V DC		
Operating current per contact	max. 2 A	max. 1.5 A	
Total current	max. 2 A	max. 1.5 A	
Protection	IP65/IP67		
Housing	Plastic, flame retardant		
Temperature range	-20...+70 °C		
<b>Contact Layout</b>			
LED display	LED (green): Power / LED (yellow): (S1) / LED (white): Signal (S2)		
PIN 1	(+) (Earth)		
PIN 2	(NC)/(S2)		
PIN 3	(-)		
PIN 4	(NO)/(S1)		
PIN 5	(Earth)		
<b>Article No.</b>			
The composition of your article number is explained on page 3.1.i	<span style="font-size: 1.2em; font-weight: bold;">8 0 0 0</span> - <span style="font-size: 1.2em; font-weight: bold;">0 0 0</span> - <span style="font-size: 1.2em; font-weight: bold;">0 0 0 0</span>		
	<b>1 Form</b>		
<b>Notes</b>			

# M12 DISTRIBUTION SYSTEMS (PLASTIC)

For sensors and actuators

– M23 plug connection



**Exact12**  
4-way



**Exact12**  
8-way

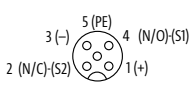
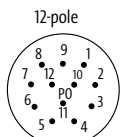
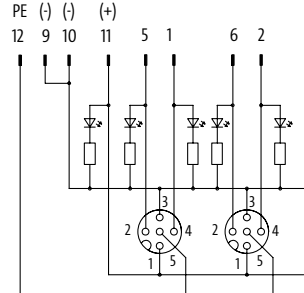
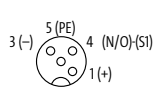
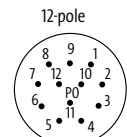
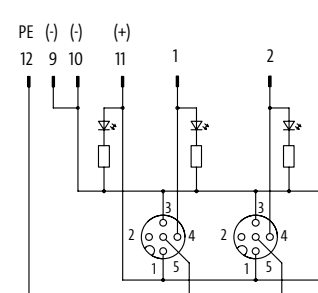

1 Form	84530	88430
Type	5-pole M23 plug connection, 12-pole	4-pole M23 plug connection, 12-pole
Contact layout	<p>M12-Females 5-pole</p>  <p>M23-Plug 12-pole</p>   <p>for 2 signals per port</p> <p>1 2</p>	<p>M12-Females 4-pole</p>  <p>M23-Plug 12-pole</p>   <p>for 1 signal per port</p> <p>1 2</p>
<b>Technical Data</b>		
Operating voltage	24 V DC	
Operating current per contact	max. 4 A	
Total current	max. 8 A	
Protection	IP65/IP67	
Housing	Plastic, flame retardant	
Temperature range	-20...+75 °C	
<b>Contact Layout</b>		
LED display	LED (green): Power / LED (yellow): (S1) / LED (white): Signal (S2)	
PIN 1	(+) / LED (white): Signal (S2)	LED (green): Power / LED (yellow): (S1)
PIN 2	(NC)/(S2)	-
PIN 3	(-)	
PIN 4	(NO)/(S1)	
PIN 5	(Earth)	
<b>Article No.</b>		
The composition of your article number is explained on page 3.1.i	<div style="display: flex; justify-content: space-around; align-items: center;"> <span><u>8 0 0 0</u></span> <span>-</span> <span>_____</span> <span>-</span> <span><u>0 0 0</u></span> <span>  </span> <span><u>0 0 0 0</u></span> </div>	
<b>1 Form</b>		
Notes		

M12 Distribution Systems (Plastic)

# M12 DISTRIBUTION SYSTEMS (PLASTIC)

For sensors and actuators

– M23 plug connection



**Exact12**

4-way



**Exact12**

8-way



<b>1 Form</b>	<b>84520</b>	<b>88520</b>
Type	5-pole M23 plug connection, 19-pole	5-pole M23 plug connection, 19-pole

Contact layout	<p>M12-Females 5-pole      M23-Plug 19-pole</p> <p>for 2 signals per port      1      2</p>	
----------------	---	--

<b>Technical Data</b>	
Operating voltage	24 V DC
Operating current per contact	max. 4 A
Total current	max. 8 A
Protection	IP65/IP67
Housing	Plastic, flame retardant
Temperature range	-20...+80 °C

<b>Contact Layout</b>	
LED display	LED (green): Power / LED (yellow): (S1) / LED (white): Signal (S2)
PIN 1	(+)
PIN 2	(NC)/(S2)
PIN 3	(-)
PIN 4	(NO)/(S1)
PIN 5	(Earth)

<b>Article No.</b>	
--------------------	--

The composition of your article number is explained on page 3.1.i	<b>8 0 0 0</b> - - - - - - - - - - <b>0 0 0</b> <b>0 0 0 0</b>
	<b>1 Form</b>

<b>Notes</b>	
--------------	--



# M12 DISTRIBUTION SYSTEMS (PLASTIC)

For general applications

– with molded homerun cable

Approvals:  Listed

## Exact12 UNIVERSAL

4-way

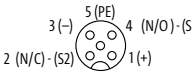
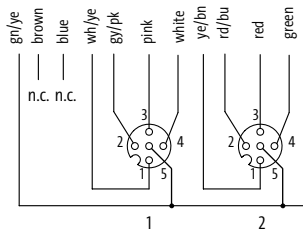

<b>1 Form</b>	<b>8 4 7 1 2</b>	
<b>Type</b>	without LED, 5-pole (for analog signals)	
<b>Contact layout</b>	<p>M12-Females 5-pole</p>   <p>free arrangeable, contact 1:1 on terminals for 4 signals per port, PINS bridged on terminals</p>	
<b>2 Cable Type</b>	<b>Jacket Color</b> – No./diameter of wires	
	gray	
	PUR/PVC (UL/CSA), Ctracks	398 – 16 × 0.34 + 3 × 0.75 mm <sup>2</sup>
<b>3 Cable Length</b>		
	3.0 m	0300
	5.0 m	0500
	10.0 m	1000
	15.0 m	1500
<b>Technical Data</b>		
Operating voltage	42 V AC/DC	
Total current	max. 10 A	
Protection	IP65/IP67	
Temperature range	-20...+70 °C, depending on cable quality	
<b>Contact Layout</b>		
PIN 1	(S1)	
PIN 2	(S2)	
PIN 3	(S3)	
PIN 4	(S4)	
PIN 5	(Earth)	
<b>Article No.</b>		
The composition of your article number is explained on page 3.1.i	<b>8 0 0 0</b> – <b>8 4 7 1 2</b> – _____	_____
	<b>1 Form</b>	<b>2 Cable Type</b>
		<b>3 Cable Length</b>
<b>Notes</b>		

M12 Distribution Systems (Plastic)

# M12 DISTRIBUTION SYSTEMS (PLASTIC)

For safety wiring

- with molded homerun cable
- Homerun cable with spring clamp terminals
- EN ISO 13849-2

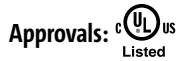

## Exact12 Safety

8-way  
for PNP signals 24 V DC



### 1 Form 98710

Type	<b>PNP, 5-pole, 4/3-pole</b>
Contact layout	<p>5-pole M12-Females 4-pole</p> <p>5 (PE) 4 (N/O)-(S1) 3 (3) 5 (PE) 4 (4)</p> <p>3 (-) 1 (+) 2 (2) 4 (4)</p> <p>2 signals 1...4 3 signals 5...8</p> <p>blue (-) brown (+)</p> <p>1 2 3 4 5 1 2 3 4 5</p> <p>1..4 5..8</p>

### 2 Cable Type Jacket Color - No./diameter of wires

	<b>gray</b>
PUR/PVC (UL/CSA)	<b>407 - 20 x 0.34 + 3 x 0.75 mm<sup>2</sup></b>

### 3 Cable Length

3.0 m	<b>0300</b>
5.0 m	<b>0500</b>
10.0 m	<b>1000</b>
15.0 m	<b>1500</b>

### Technical Data

Operating voltage	24 V DC
Total current	max. 8 A
Protection	IP65/IP67
Temperature range	-20...+60 °C, depending on cable quality

### Contact Layout

LED display	LED (green): Power / LED (yellow): (S1) / LED (white): Signal (S2) port 1...4
PIN 1	(+) port 1...4
PIN 2	(NC)/(S2) port 1...4; (S1) port 5...8
PIN 3	(-) port 1...4; (S2) port 5...8
PIN 4	(NO)/(S1) port 1...4; (S3) port 5...8
PIN 5	(Earth)

### Article No.

The composition of your article number is explained on page 3.1.i	<b>8 0 0 0 - 9 8 7 1 0 -</b>	_ _ _ _	_ _ _ _
	<b>1 Form</b>	<b>2 Cable Type</b>	<b>3 Cable Length</b>

Notes
-------

M12 Distribution Systems (Plastic)

# M12 DISTRIBUTION SYSTEMS (PLASTIC)

For safety wiring

– Basic module

– EN ISO 13849-2

Approvals:  Listed

## Exact12 Safety

8-way  
for PNP signals 24 V DC

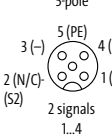
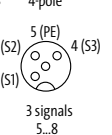
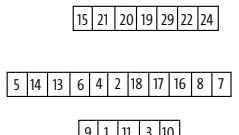
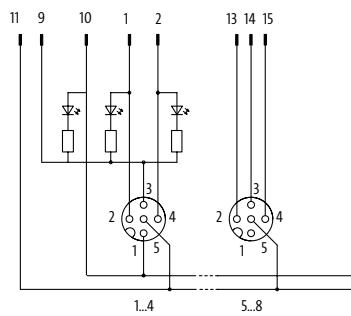

## 1 Form 98700

Type	PNP, 5-pole, 4/3-pole
Contact layout	<div style="display: flex; justify-content: space-around;"> <div style="text-align: center;"> <p>5-pole M12-Females</p>  <p>3 (-) 5 (PE) 4 (N/O)-(S1) 1 (+) 2 (N/C)-(S2) 2 signals 1..4</p> </div> <div style="text-align: center;"> <p>4-pole</p>  <p>3 (S2) 5 (PE) 4 (S3) 2 (S1) 3 signals 5..8</p> </div> </div> <div style="text-align: center; margin-top: 10px;">  </div> <div style="text-align: center; margin-top: 20px;">  <p>11 9 10 1 2 13 14 15</p> <p>1..4 5..8</p> </div>

## Technical Data

Operating voltage	24 V DC
Operating current per contact	max. 4 A
Total current	max. 8 A
Protection	IP65/IP67
Housing	Plastic, flame retardant
Locking of ports	Screw thread M12 × 1 mm
Temperature range	-20...+60 °C

## Contact Layout

LED display	LED (green): Power / LED (yellow): (S1) / LED (white): Signal (S2) port 1..4
PIN 1	(+) port 1..4
PIN 2	(NC)/(S2) port 1..4; (S1) port 5..8
PIN 3	(-) port 1..4; (S2) port 5..8
PIN 4	(NO)/(S1) port 1..4; (S3) port 5..8
PIN 5	(Earth)

## Article No.

The composition of your article number is explained on page 3.1.i	<span style="font-size: 1.2em; font-weight: bold;">8 0 0 0</span> - <span style="font-size: 1.2em; font-weight: bold;">9 8 7 0 0</span> - <span style="font-size: 1.2em; font-weight: bold;">0 0 0</span> <span style="font-size: 1.2em; font-weight: bold;">0 0 0 0</span>
	1 Form

## Notes

Notes	
-------	--

# M12 DISTRIBUTION SYSTEMS (PLASTIC)

For safety wiring

- Connection cap
- Homerun cable with spring clamp terminals
- EN ISO 13849-2

Approvals:  **UL** us  
Listed

**Exact12 Safety**  
for 8-way distribution boxes



## 1 Form 98749

**Type** 5-, 4-pole

**Contact layout**

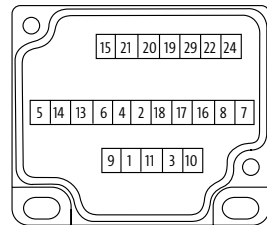
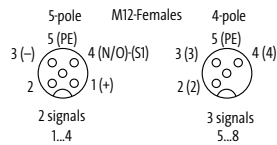

## 2 Cable Type Jacket Color – No./diameter of wires

**Jacket Color** gray

PUR (UL/CSA), robots/C-tracks 408 – 20 × 0.34 + 3 × 0.75 mm<sup>2</sup>

## 3 Cable Length

3.0 m	<b>0300</b>
5.0 m	<b>0500</b>
10.0 m	<b>1000</b>
15.0 m	<b>1500</b>
20.0 m	<b>2000</b>

## Technical Data

Total current max. 8 A

Temperature range -20...+80 °C, depending on cable quality

## Article No.

The composition of your article number is explained on page 3.1.i

**8 0 0 0** – **9 8 7 4 9** – \_\_\_\_\_

**1** Form **2** Cable Type **3** Cable Length

Notes

# M12 DISTRIBUTION SYSTEMS (PLASTIC)

For sensors and actuators

– Rear connection

– EN ISO 13849-2

Approvals:  Listed

## Exact12 Safety



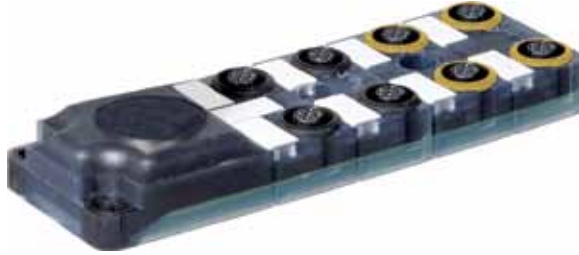

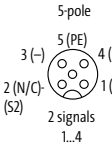
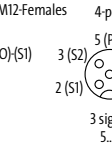
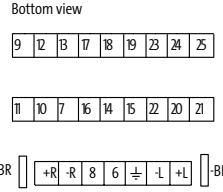
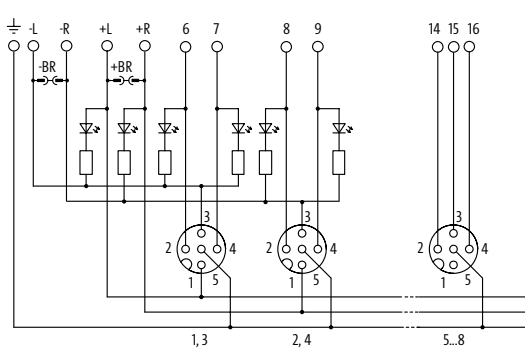
Rear connection  
with potential separation









<b>1 Form</b>	<b>98790</b>
Type	PNP, 5-pole, 4/3-pole Spring clamp terminals
Contact layout	<div style="display: flex; justify-content: space-around;"> <div style="text-align: center;"> <p>5-pole</p>  <p>2 signals 1...4</p> </div> <div style="text-align: center;"> <p>M12-Females</p>  <p>3 signals 5...8</p> </div> <div style="text-align: center;"> <p>Bottom view</p>  </div> </div> <div style="text-align: center; margin-top: 20px;">  </div>
<b>Technical Data</b>	
Operating voltage	24 V DC
Operating current per contact	max. 4 A
Total current	max. 8 A
Protection	IP65/IP67
Housing	Plastic, flame retardant
Locking of ports	Screw thread M12 × 1 mm
Temperature range	-20...+60 °C
<b>Contact Layout</b>	
LED display	LED (green): Power / LED (yellow): (S1) / LED (white): Signal (S2) port 1...4
PIN 1	(+) port 1...4
PIN 2	(NC)/(S2) port 1...4; (S1) port 5...8
PIN 3	(-) port 1...4; (S2) port 5...8
PIN 4	(NO)/(S1) port 1...4; (S3) port 5...8
PIN 5	(Earth)
<b>Article No.</b>	
The composition of your article number is explained on page 3.1.i	<span style="font-size: 1.2em; font-weight: bold; border-bottom: 1px solid black; padding: 0 5px;">8</span> <span style="font-size: 1.2em; font-weight: bold; border-bottom: 1px solid black; padding: 0 5px;">0</span> <span style="font-size: 1.2em; font-weight: bold; border-bottom: 1px solid black; padding: 0 5px;">0</span> <span style="font-size: 1.2em; font-weight: bold; border-bottom: 1px solid black; padding: 0 5px;">0</span> <span style="font-size: 1.2em; font-weight: bold; padding: 0 10px;">-</span> <span style="font-size: 1.2em; font-weight: bold; border-bottom: 1px solid black; padding: 0 5px;">9</span> <span style="font-size: 1.2em; font-weight: bold; border-bottom: 1px solid black; padding: 0 5px;">8</span> <span style="font-size: 1.2em; font-weight: bold; border-bottom: 1px solid black; padding: 0 5px;">7</span> <span style="font-size: 1.2em; font-weight: bold; border-bottom: 1px solid black; padding: 0 5px;">9</span> <span style="font-size: 1.2em; font-weight: bold; border-bottom: 1px solid black; padding: 0 5px;">0</span> <span style="font-size: 1.2em; font-weight: bold; padding: 0 10px;">-</span> <span style="font-size: 1.2em; font-weight: bold; border-bottom: 1px solid black; padding: 0 5px;">0</span> <span style="font-size: 1.2em; font-weight: bold; border-bottom: 1px solid black; padding: 0 5px;">0</span> <span style="font-size: 1.2em; font-weight: bold; border-bottom: 1px solid black; padding: 0 5px;">0</span> <span style="font-size: 1.2em; font-weight: bold; padding: 0 10px;">-</span> <span style="font-size: 1.2em; font-weight: bold; border-bottom: 1px solid black; padding: 0 5px;">0</span> <span style="font-size: 1.2em; font-weight: bold; border-bottom: 1px solid black; padding: 0 5px;">0</span> <span style="font-size: 1.2em; font-weight: bold; border-bottom: 1px solid black; padding: 0 5px;">0</span> <span style="font-size: 1.2em; font-weight: bold; border-bottom: 1px solid black; padding: 0 5px;">0</span>
	<b>1 Form</b>
<b>Notes</b>	

M12 Distribution Systems (Plastic)

# M12 DISTRIBUTION SYSTEMS (PLASTIC)

Mounting accessories			Art-No.
	<b>Torque wrench set</b> M12 (0.6 Nm, SW13)	M12 data connenctor molded (standard)	7000-99102-0000000
	<b>Torque wrench</b> M12 (0.6 Nm, SW13)	M12 data connenctor molded (standard)	7000-99109-0000000
	<b>Torque wrench</b> M12 (0.6 Nm, SW14)	M12 data connenctor moulded (Xtreme)	7000-99108-0000000
	<b>Torque wrench</b> M12 (0.6 Nm, SW17)	M12 field-wireable (IDC terminal)	7000-99094-0000000
	<b>Torque wrench</b> M12 (0.6 Nm, SW18)	M12 field-wireable via (screw terminals)	7000-99103-0000000
	<b>DIN-rail adapter</b> with fixing screws, plastic		27905
	<b>V2A guard</b> Exact12 ATEX, 4-way	for 8099-84510-448xxxx	996082
	<b>V2A guard</b> Exact12 ATEX, 8-way	for 8099-88510-452xxxx	996083
Plug accessories			Art-No.
	<b>Transfer module</b> for 1 × 11- and 1 × 12-pole spring clamp terminals		596154
	<b>Service adapter</b> with LED and SUB-D25	for transfer module Art-No. 596154	596153

## M12 DISTRIBUTION SYSTEMS (PLASTIC)

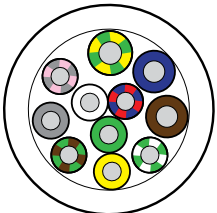
Plug accessories			Art-No.
	<b>Screw plug M12 x 1 mm</b> Metal, hex, 1 piece		996049
	<b>Screw plug M12 x 1 mm (for female)</b> Plastic, hex without gasket	Quantity: 10 pcs.	58627
	<b>Label plates</b> KES 20 x 8 (white)	(10 pieces/2 plates)	996067
	<b>Label plates</b> KES 17 x 9 (Type M) (12 pieces/2 plates)		996050
	<b>Adapter M8/M12</b> 3-pole	M12 Distribution Systems	7000-42201-000000
	<b>Adapter M8/M12</b> 4-pole	M12 Distribution Systems	7000-42211-000000
Homerun cable accessories			Art-No.
	<b>Coding element</b> for 6 codings		996054
	<b>Screw plug M23</b> Metal		55352
	<b>Screw plug M12 x 1 mm (for male)</b> Plastic	Quantity: 4 pcs.	56951
	<b>Cable rings (50 m), 5-pole, PUR/PVC</b> 8x0.34 + 3x0.75 mm <sup>2</sup>	4-way distribution boxes M12	8000-00000-3635000
	12x0.34 + 3x0.75 mm <sup>2</sup>	6-way distribution boxes M12	8000-00000-3885000
	16x0.34 + 3x0.75 mm <sup>2</sup>	8-way distribution boxes M12	8000-00000-3985000

# M12 DISTRIBUTION SYSTEMS (PLASTIC)

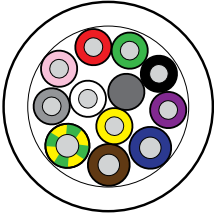
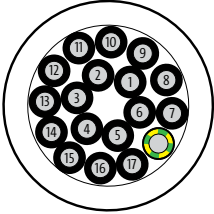
Homerun cable accessories			Art-No.	
	<b>Cable rings (50 m), 4-pole, PUR (UL/CSA), halogen free</b>	8-way distribution boxes M12	<b>8000-00000-4475000</b>	
		8×0.5 + 3×1.0 mm <sup>2</sup>	4-way distribution boxes M12	<b>8000-00000-4485000</b>
		8×0.5 + 3×1.0 mm <sup>2</sup>	8-way distribution boxes M12	<b>8000-00000-4525000</b>
		16×0.5 + 3×1.0 mm <sup>2</sup>	8-way distribution boxes M12, potentially separated	<b>8000-00000-4035000</b>
		16×0.34 + 5×0.75 mm <sup>2</sup>		
	<b>Cable rings (50 m), PUR/PVC</b>	4-way distribution box M12, UNIVERSAL	<b>8000-00000-5335000</b>	
		18 × 0.75 mm <sup>2</sup>	4-way distribution boxes M12	<b>8000-00000-3335000</b>
		4×0.34 + 3×0.75 mm <sup>2</sup>	8-way distribution boxes M12	<b>8000-00000-3625000</b>
		8×0.34 + 3×0.75 mm <sup>2</sup>	4-way distribution boxes M12, potentially separated	<b>8000-00000-3745000</b>
		8×0.34 + 5×0.75 mm <sup>2</sup>	8-way distribution boxes M12, potentially separated	<b>8000-00000-4045000</b>
		16×0.34 + 5×0.75 mm <sup>2</sup>		



# M12 DISTRIBUTION SYSTEMS (PLASTIC)

## M12 Distribution Systems Technical Data

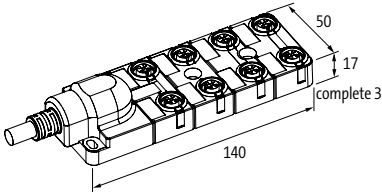
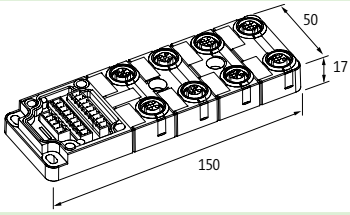
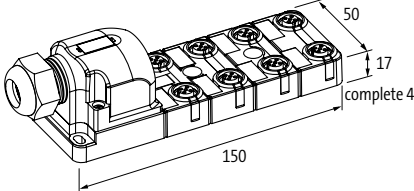
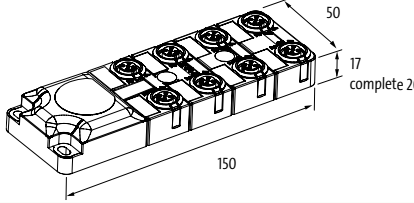
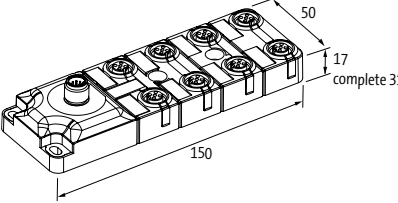
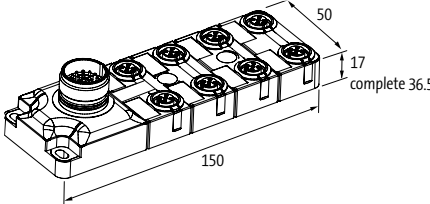
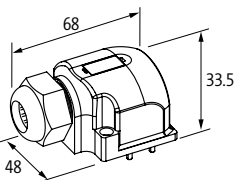
	Description	4-way	8-way
	<b>Exact12</b> Molded homerun cable	90 mm	140 mm
	<b>Exact12</b> Basic module	100 mm	150 mm
	<b>Exact12 and MSDS8</b> Sets: basic module and cap Field-wireable	100 mm	150 mm
	<b>Exact12</b> Rear connection	100 mm	150 mm
	<b>Exact12</b> M12 plug connection	100 mm	150 mm
	<b>Exact12</b> M23 plug connection	100 mm	150 mm
	<b>Exact12</b> Caps		

Art.-No., page	Art.-No., page	Art.-No., page	Art.-No., page	Art.-No., page
<b>5-digit Art.-No.</b>				
10415, 1.7.2	20103, 1.8.11	23163, 1.8.16	26619, 1.8.11	52003, 1.9.6
10416, 1.7.2	20680, 1.8.10	23164, 1.8.16	26720, 1.8.10	52004, 1.9.7
10460, 1.7.3	20682, 1.8.10	23170, 1.8.13	26722, 1.8.10	52005, 1.9.6
10461, 1.7.3	20683, 1.8.10	23171, 1.8.13	26723, 1.8.10	52015, 1.9.4
10462, 1.7.3	20687, 1.8.10	23172, 1.8.13	26724, 1.8.10	52030, 1.9.5
10463, 1.7.3	20688, 1.8.10	23173, 1.8.13	27905, 4.12.10, 4.13.35	52031, 1.9.8
10464, 1.7.3	21054, 1.8.4	23174, 1.8.13	50010, 1.10.13	52040, 1.9.5
10466, 1.7.3	21060, 1.8.7	23175, 1.8.13	50015, 1.10.16	52041, 1.9.8
10470, 1.7.4	21063, 1.8.7	23180, 1.8.16	50030, 1.10.23	52050, 1.9.4
10471, 1.7.4	21070, 1.8.7	23181, 1.8.16	50034, 1.10.22	52102, 1.9.9
10472, 1.7.4	21071, 1.8.7	23220, 1.8.15	50040, 1.10.12	52103, 1.9.9
10510, 1.7.5	21172, 1.8.1	26001, 1.8.10	50041, 1.10.12	52104, 1.9.10
10511, 1.7.5	21173, 1.8.1	26013, 1.8.3	50043, 1.10.16	52106, 1.9.10
10512, 1.7.5	22050, 1.8.9	26014, 1.8.3	50044, 1.10.16	52110, 1.9.9
10513, 1.7.5	22051, 1.8.9	26015, 1.8.3	50070, 1.10.13	52111, 1.9.9
10531, 1.7.7	22052, 1.8.9	26020, 1.8.11	50080, 1.10.14	52130, 1.9.9
10532, 1.7.7	22054, 1.8.9	26034, 1.8.9	50081, 1.10.14	52136, 1.9.9
10533, 1.7.7	23000, 1.8.15	26036, 1.8.9	50082, 1.10.15	52140, 1.9.9
10534, 1.7.7	23001, 1.8.15	26038, 1.8.9	50085, 1.10.15	52146, 1.9.9
10535, 1.7.7	23002, 1.8.15	26039, 1.8.9	50092, 1.10.23	52160, 1.9.11
10537, 1.7.7	23003, 1.8.15	26051, 1.8.9	50105, 1.10.12	52500, 1.10.5
10538, 1.7.7	23004, 1.8.15	26073, 1.8.10	50110, 1.10.14	52501, 1.10.3
10539, 1.7.7	23005, 1.8.15	26079, 1.8.1	50140, 1.10.17	52502, 1.10.2
10550, 1.7.8	23006, 1.8.15	26086, 1.8.4	51100, 1.9.15	52503, 1.10.9
10551, 1.7.8	23007, 1.8.15	26090, 1.8.11	51108, 1.9.15	52505, 1.10.3
10552, 1.7.8	23009, 1.8.15	26095, 1.8.11	51120, 1.9.15	52506, 1.10.6
10553, 1.7.8	23011, 1.8.12	26097, 1.8.11	51125, 1.9.15	52507, 1.10.6
10554, 1.7.8	23015, 1.8.15	26120, 1.8.10	51130, 1.9.16	52508, 1.10.7
10555, 1.7.8	23016, 1.8.15	26130, 1.8.11	51138, 1.9.16	52510, 1.10.8
10556, 1.7.8	23017, 1.8.15	26150, 1.8.11	51140, 1.9.16	52511, 1.10.9
10571, 1.7.6	23018, 1.8.15	26155, 1.8.11	51300, 1.9.18	52512, 1.10.8
10572, 1.7.6	23022, 1.8.12	26180, 1.8.10	51301, 1.9.18	52513, 1.10.11
10574, 1.7.6	23035, 1.8.12	26181, 1.8.10	51302, 1.9.18	52515, 1.10.2
10575, 1.7.6	23043, 1.8.12	26182, 1.8.10	51403, 1.9.19	52519, 1.10.4
10577, 1.7.6	23050, 1.8.12	26183, 1.8.10	51410, 1.9.17	52520, 1.10.4
10578, 1.7.6	23050, 1.8.12	26184, 1.8.10	51412, 1.9.17	52521, 1.10.5
10701, 1.7.1	23056, 1.8.12	26277, 1.8.1	51413, 1.9.17	52550, 1.10.18
20001, 1.8.10	23100, 1.8.12	26278, 1.8.1	51465, 1.9.17	52551, 1.10.18
20002, 1.8.10	23102, 1.8.12	26283, 1.8.9	51485, 1.9.17	52556, 1.10.20
20004, 1.8.10	23103, 1.8.12	26317, 1.8.9	51508, 1.9.13	52557, 1.10.20
20007, 1.8.3	23104, 1.8.12	26400, 1.8.5	51515, 1.9.13	52561, 1.10.21
20008, 1.8.3	23106, 1.8.12	26401, 1.8.5	51517, 1.9.14	52571, 1.10.19
20009, 1.8.3	23115, 1.8.12	26403, 1.8.5	51526, 1.9.14	52572, 1.10.10
20010, 1.8.10	23118, 1.8.12	26404, 1.8.5	51540, 1.9.17	54500, 4.5.1
20011, 1.8.10	23141, 1.8.13	26440, 1.8.1	51551, 1.9.13	54501, 4.5.1
20012, 1.8.10	23142, 1.8.13	26476, 1.8.7	51552, 1.9.13	54502, 4.5.2
20013, 1.8.10	23144, 1.8.13	26481, 1.8.7	51560, 1.9.14	54503, 4.5.2
20014, 1.8.10	23145, 1.8.13	26530, 1.8.9	51562, 1.9.13	54504, 4.5.3
20031, 1.8.11	23146, 1.8.13	26576, 1.8.9	51571, 1.9.14	54505, 4.5.4
20032, 1.8.11	23147, 1.8.13	26578, 1.8.9	51808, 1.9.12	54506, 4.5.4
20033, 1.8.11	23149, 1.8.13	26588, 1.8.9	51851, 1.9.12	55033, 4.10.1
20034, 1.8.11	23151, 1.8.16	26613, 1.8.11	51860, 1.9.14	55034, 4.10.1
20100, 1.8.11	23157, 1.8.16	26614, 1.8.11	52000, 1.9.4	55035, 4.10.1
20101, 1.8.11	23160, 1.8.16	26615, 1.8.11	52001, 1.9.4	55036, 4.10.1
20102, 1.8.11	23161, 1.8.16	26616, 1.8.11	52002, 1.9.4	55037, 4.10.1

# INDEX

Art.-No., page	Art.-No., page	Art.-No., page	Art.-No., page	Art.-No., page
55038, 4.10.2	55390, 4.4.17	56078, 4.2.11	56446, 4.9.3	56691, 4.1.13
55059, 4.10.4	55468, 4.10.7	56079, 4.2.11	56447, 4.9.6	56700, 4.1.17
55060, 4.10.4	55518, 4.7.8	56080, 4.2.11	56448, 4.9.7	56701, 4.1.17
55061, 4.10.5	55519, 4.7.8	56081, 4.2.11	56450, 4.2.3	56710, 4.1.19
55062, 4.10.5	55528, 4.4.7	56082, 4.2.12	56453, 4.10.4	56711, 4.1.19
55071, 4.6.10	55529, 4.4.7	56083, 4.2.12	56454, 4.10.2	56720, 4.1.19
55072, 4.6.10	55530, 4.4.10	56084, 4.2.11	56455, 4.10.7	56721, 4.1.19
55073, 4.6.10	55531, 4.4.11	56085, 4.2.11	56458, 4.8.1	56730, 4.1.17
55074, 4.6.10	55532, 4.4.11	56109, 4.2.11	56462, 4.9.4	56731, 4.1.17
55075, 4.6.9	55542, 4.4.14	56110, 4.2.11	56469, 4.8.1	56740, 4.1.18
55076, 4.6.9	55543, 4.4.15	56111, 4.2.11	56470, 4.8.1	56741, 4.1.18
55077, 4.6.9	55544, 4.4.15	56112, 4.2.5	56471, 4.8.1	56748, 4.1.18
55078, 4.6.9	55550, 2.5.1	56113, 4.2.11	56473, 4.8.1	56749, 4.1.18
55081, 4.6.8	55554, 4.4.18	56117, 4.2.6	56474, 4.9.7	56750, 4.1.15
55082, 4.6.8	55556, 4.4.13	56118, 4.2.7	56475, 4.8.3	56761, 4.1.16
55083, 4.6.8	55557, 4.4.13	56140, 4.2.4	56476, 4.8.3	56766, 4.1.14
55084, 4.6.8	55562, 4.4.12	56168, 4.2.5	56477, 4.8.3	56945, 4.1.32
55085, 4.6.5	55563, 4.4.12	56200, 4.2.8	56478, 4.8.3	56946, 4.1.32
55086, 4.6.5	55575, 4.10.1	56220, 4.2.10	56521, 4.1.1	56947, 4.1.32
55087, 4.6.5	55583, 4.2.11, 4.3.14	56230, 4.2.9	56526, 4.1.1	56948, 4.1.32
55088, 4.6.5	55584, 3.6.36	56240, 4.2.9	56527, 4.1.2	56949, 4.1.32
55089, 4.6.6	55584, 4.2.11, 4.3.14	56400, 4.9.2	56535, 4.1.2	56951, 4.1.30, 4.11.15, 4.13.36
55091, 4.6.2	55585, 3.6.36	56401, 4.9.2	56600, 4.1.7	56952, 4.1.30, 4.10.7
55092, 4.6.2	55585, 4.2.11, 4.3.14	56404, 4.9.2	56601, 4.1.9	56953, 4.1.31
55093, 4.6.2	55586, 3.6.37	56405, 4.9.1	56602, 4.1.4	56955, 4.1.31
55094, 4.6.2	55586, 4.2.11, 4.3.14	56406, 4.9.2	56603, 4.1.5	56960, 4.1.31
55099, 4.4.14	55587, 4.2.11, 4.3.14	56408, 4.9.2	56605, 4.1.20	56961, 4.1.31
55130, 4.6.3	55588, 4.2.11, 4.3.14	56412, 4.10.2	56606, 4.1.6	56962, 4.1.31, 4.10.6
55131, 4.6.4	55604, 4.10.1, 4.10.4	56413, 4.9.2	56610, 4.1.8	56963, 4.1.31, 4.10.6
55132, 4.6.4	55605, 4.10.1	56414, 4.9.2	56611, 4.1.9	56965, 4.1.31
55142, 4.6.6	55606, 4.10.1	56415, 4.9.3	56612, 4.1.4	56968, 4.1.3
55143, 4.6.7	55607, 4.10.1	56416, 4.10.2	56613, 4.1.5	57018, 4.4.16
55144, 4.6.7	55611, 4.10.1	56418, 4.9.4	56616, 4.1.6	57101, 4.3.1
55254, 4.4.6	55680, 4.9.1	56419, 4.9.4	56620, 4.1.8	57103, 4.3.2
55255, 4.4.6	55681, 4.9.1	56420, 4.9.4	56621, 4.1.10	57104, 4.3.3
55274, 4.4.2	55682, 4.9.1	56421, 4.9.5	56622, 4.1.4	57105, 4.3.2
55283, 4.4.8	55696, 4.10.3	56422, 4.9.6	56623, 4.1.5	57106, 4.3.1
55290, 4.4.2	55700, 4.8.2	56423, 4.9.6	56625, 4.1.11	57108, 4.3.3
55291, 4.4.3	55701, 4.8.2	56424, 4.9.5	56626, 4.1.6	57120, 4.3.4
55292, 4.4.4	55727, 4.10.3	56425, 4.9.5	56627, 4.1.11	57121, 4.3.4
55293, 4.4.5	55741, 4.10.2, 4.10.4	56426, 4.9.5	56631, 4.1.10	57122, 4.3.4
55307, 4.4.1	55742, 4.10.4	56427, 4.9.6	56640, 4.1.7	57130, 4.3.5
55308, 4.4.1	55743, 4.10.5	56428, 4.9.6	56641, 4.1.12	57131, 4.3.5
55309, 4.4.1	55744, 4.10.5	56432, 4.10.5	56642, 4.1.12	57190, 4.3.14
55316, 4.1.30	55746, 4.10.5	56433, 4.10.5	56650, 4.1.27	57191, 4.3.14
55317, 4.4.17	55749, 4.10.2, 4.10.4	56434, 4.9.3	56651, 4.1.23	57220, 4.3.6
55318, 4.1.30, 4.4.17, 4.5.5, 4.6.11, 4.7.10, 4.10.7	55760, 3.6.36	56435, 4.9.3	56653, 4.1.28	57230, 4.3.12
55339, 4.4.9	55760, 4.2.11, 4.3.14	56436, 4.9.4	56655, 4.1.23	57231, 4.3.11
55345, 4.6.1	55762, 3.6.36	56438, 4.9.6	56656, 4.1.23	57232, 4.3.11
55346, 4.6.1	55762, 4.2.11, 4.3.14	56439, 4.9.5	56657, 4.1.28	57233, 4.3.11
55347, 4.6.1	55779, 4.10.3	56440, 4.8.3	56661, 4.1.24	57240, 4.3.6
55348, 4.6.1	56001, 4.2.1	56442, 4.9.7	56662, 4.1.25	57261, 4.3.11
55352, 4.4.17, 4.12.11, 4.13.36	56005, 4.2.2	56443, 4.9.5	56663, 4.1.26	57262, 4.3.11
55385, 4.1.30, 4.6.11	56006, 4.2.1	56444, 4.9.5	56671, 4.1.25	57263, 4.3.11
	56077, 4.2.11	56445, 4.9.3	56681, 4.1.13	57265, 4.3.12

Art.-No., page	Art.-No., page	Art.-No., page	Art.-No., page	Art.-No., page
57280, 4.3.6	85131, 1.2.16	85644, 1.2.13	86154, 1.1.6	86485, 1.1.5
57290, 4.3.7	85132, 1.2.16	85650, 1.5.2	86155, 1.1.6	86486, 1.1.5
57320, 4.3.8	85133, 1.2.16	85655, 1.5.1	86157, 1.1.6	87011, 1.2.18
57325, 4.3.9	85135, 1.2.17	85656, 1.5.1	86306, 1.1.4	87012, 1.2.19
57327, 4.3.9	85137, 1.2.17	85657, 1.5.1	86307, 1.1.4	87013, 1.2.18
57331, 4.3.13	85148, 1.2.20	85658, 1.5.1	86308, 1.1.4	87014, 1.2.19
57333, 4.3.13	85349, 1.1.10	85659, 1.5.1	86309, 1.1.4	87015, 1.2.18
57340, 4.3.8	85350, 1.1.10	85660, 1.5.2	86310, 1.1.4	87016, 1.2.19
57345, 4.3.9	85351, 1.1.10	85676, 1.2.9	86311, 1.1.4	87017, 1.2.18
57361, 4.3.13	85352, 1.1.11	85690, 1.2.5	86326, 1.1.4	87018, 1.2.19
57363, 4.3.13	85353, 1.1.11	85691, 1.2.5	86327, 1.1.4	87111, 1.2.18
57380, 4.3.8	85354, 1.1.11	85692, 1.2.6	86328, 1.1.4	87112, 1.2.19
57390, 4.3.10	85355, 1.1.9	85693, 1.2.6	86329, 1.1.4	87113, 1.2.18
58151, 1.11.1	85356, 1.1.9	85695, 1.2.5	86330, 1.1.4	87114, 1.2.19
58152, 1.11.1	85357, 1.1.10	85696, 1.2.5	86331, 1.1.4	87115, 1.2.18
58160, 1.11.3	85360, 1.1.8	85697, 1.2.6	86340, 1.1.1	87116, 1.2.19
58161, 1.11.3	85361, 1.1.8	85698, 1.2.6	86341, 1.1.1	87117, 1.2.18
58170, 1.11.1	85362, 1.1.8	85700, 1.5.3	86342, 1.1.1	87118, 1.2.19
58171, 1.11.1	85363, 1.1.8	85702, 1.2.1	86343, 1.1.1	87690, 1.2.5
58172, 1.11.2	85364, 1.1.9	85703, 1.2.1	86345, 1.1.1	87691, 1.2.5
58173, 1.11.2	85381, 4.8.4	85704, 1.2.1	86346, 1.1.1	87692, 1.2.6
58181, 1.11.4	85382, 4.8.4	85710, 1.5.3	86347, 1.1.1	87693, 1.2.6
58182, 1.11.4	85383, 1.2.7	85712, 1.2.3	86348, 1.1.1	89550, 1.3.8
58183, 1.11.5	85383, 4.8.4	85722, 1.2.2	86349, 1.1.1	89552, 1.3.8
58184, 1.11.7	85394, 1.3.5	85723, 1.2.2	86351, 1.1.1	89553, 1.3.8
58185, 1.11.6	85396, 1.3.7	85724, 1.2.2	86360, 1.1.2	89554, 1.3.8
58186, 1.11.6	85400, 1.1.12	85730, 1.5.3	86361, 1.1.2	89555, 1.3.8
58627, 4.1.30, 4.5.5, 4.6.11, 4.7.10, 4.10.7, 4.13.36	85401, 1.1.12	85921, 1.1.13	86362, 1.1.2	90901, 1.9.28, 1.10.24
59401, 4.7.9	85402, 1.1.12	85923, 1.1.13	86363, 1.1.2	90931, 1.9.28, 1.10.24
59402, 4.7.9	85403, 1.1.12	85925, 1.1.13	86365, 1.1.2	90931, 4.5.5
59450, 4.7.7	85404, 1.1.12	85927, 1.1.13	86366, 1.1.2	90960, 1.9.28, 1.10.24
59451, 4.7.7	85405, 1.1.12	85929, 1.1.13	86367, 1.1.2	90961, 1.9.28, 1.10.24
59452, 4.7.10	85414, 1.3.1	85931, 1.1.13	86368, 1.1.2	90970, 1.9.28, 1.10.24
69000, 2.5.1	85415, 1.3.1	85933, 1.1.13	86369, 1.1.2	90971, 1.9.28, 1.10.24
69001, 2.5.1	85434, 1.2.3	85935, 1.1.13	86371, 1.1.2	90975, 1.9.28, 1.10.24
69002, 2.5.1	85437, 1.2.2	85937, 1.1.13	86450, 1.1.7	90976, 1.9.28, 1.10.24
69003, 2.5.1	85438, 1.2.2	85939, 1.1.13	86451, 1.1.7	90977, 1.9.29, 1.10.25
69004, 2.5.1	85439, 1.2.2	85953, 1.1.13	86452, 1.1.7	90980, 1.9.28, 1.10.24
69010, 2.5.1	85440, 1.2.1	85954, 1.1.13	86453, 1.1.7	90982, 1.9.28, 1.10.24
69011, 2.5.1	85441, 1.2.1	85955, 1.1.13	86454, 1.1.7	
69012, 2.5.1	85442, 1.2.1	85956, 1.1.13	86455, 1.1.7	
69013, 2.5.1	85449, 1.2.4	85957, 1.1.13	86456, 1.1.7	
69040, 2.5.1	85458, 1.3.2	86140, 1.1.3	86463, 1.1.5	
69041, 2.5.1	85459, 1.3.2	86141, 1.1.3	86464, 1.1.5	
69042, 2.5.1	85460, 1.3.3	86142, 1.1.3	86465, 1.1.5	
69043, 2.5.1	85462, 1.3.3	86143, 1.1.3	86466, 1.1.5	
85000, 1.2.10	85467, 1.3.4	86144, 1.1.3	86470, 1.1.7	
85001, 1.2.10	85468, 1.3.4	86145, 1.1.6	86471, 1.1.7	
85002, 1.2.11	85469, 1.3.4	86146, 1.1.6	86472, 1.1.7	
85004, 1.2.11	85495, 1.3.6	86147, 1.1.6	86473, 1.1.7	
85009, 1.2.14	85496, 1.3.6	86148, 1.1.6	86474, 1.1.7	
85010, 1.2.14	85600, 1.5.2	86150, 1.1.6	86475, 1.1.7	
85011, 1.2.14	85640, 1.2.12	86151, 1.1.6	86476, 1.1.7	
85016, 1.2.15	85641, 1.2.12	86152, 1.1.6	86483, 1.1.5	
	85642, 1.2.13	86153, 1.1.6	86484, 1.1.5	

# INDEX

Art.-No., page	Art.-No., page	Art.-No., page	Art.-No., page	Art.-No., page
6-digit Art.-No.	7-digit Art.-No.			
230563, 1.8.15	3124015, 1.8.17	5665111, 4.1.29	6652040, 1.9.5	6686361, 1.1.2
233463, 1.8.15	3124016, 1.8.17	5665112, 4.1.29	6652041, 1.9.8	6686362, 1.1.2
236082, 1.8.15	3124017, 1.8.17	5665113, 4.1.29	6652050, 1.9.4	6686363, 1.1.2
236139, 1.8.14	3124018, 1.8.17	5665114, 4.1.29	6652102, 1.9.9	6686365, 1.1.2
236141, 1.8.14	3124021, 1.8.17	5665115, 4.1.29	6652103, 1.9.9	6686366, 1.1.2
236142, 1.8.14	3124033, 1.8.17	5665116, 4.1.29	6652104, 1.9.10	6686367, 1.1.2
236148, 1.8.14	3124046, 1.8.17	5665118, 4.1.29	6652106, 1.9.10	6686368, 1.1.2
236149, 1.8.14	3124048, 1.8.17	5665119, 4.1.29	6652110, 1.9.9	6686369, 1.1.2
512498, 1.9.19	3124049, 1.8.17	5665120, 4.1.29	6652111, 1.9.9	6686371, 1.1.2
512764, 1.9.13	3124052, 1.8.17	5665151, 4.1.29	6652130, 1.9.9	8985349, 1.1.10
516014, 1.9.16	3124063, 1.8.17	5665500, 4.1.29	6652136, 1.9.9	8985350, 1.1.10
526071, 1.10.10	3124064, 1.8.17	5665501, 4.1.29	6652140, 1.9.9	8985351, 1.1.10
526100, 1.10.10	3124068, 1.8.17	5665502, 4.1.29	6652146, 1.9.9	8985360, 1.1.8
553260, 4.4.17	3124070, 1.8.17	5665503, 4.1.26	6652500, 1.10.5	8985361, 1.1.8
556510, 4.8.2	3124071, 1.8.17	5665600, 4.1.29	6652501, 1.10.3	8985362, 1.1.8
556511, 4.8.2	3124072, 1.8.17	5665601, 4.1.29	6652502, 1.10.2	
556613, 4.9.1	3124072, 1.8.17	5665602, 4.1.29	6652503, 1.10.9	
556614, 4.9.1	3124115, 1.8.18	5665603, 4.1.29	6652505, 1.10.3	
556625, 4.8.2	3124116, 1.8.18	5665604, 4.1.29	6652506, 1.10.6	
556639, 4.8.2	3124121, 1.8.18	5665604, 4.1.29	6652506, 1.10.6	
564201, 4.9.4	3124133, 1.8.18	5665605, 4.1.29	6652507, 1.10.6	
564501, 4.2.3	3124148, 1.8.18	5665606, 4.1.29	6652508, 1.10.7	
596153, 4.13.35	3124163, 1.8.18	5665607, 4.1.29	6652510, 1.10.8	
596154, 4.13.35	3124169, 1.8.18	5665609, 4.1.29	6652511, 1.10.9	
996049, 4.4.17, 4.12.10, 4.13.36	3124170, 1.8.18	5665610, 4.1.29	6652512, 1.10.8	
996050, 4.13.36	3124215, 1.8.17	5665611, 4.1.29	6652513, 1.10.11	
996054, 4.13.36	3124216, 1.8.17	5665613, 4.1.29	6652515, 1.10.2	
996064, 4.12.10	3124221, 1.8.17	5665614, 4.1.29	6652519, 1.10.4	
996065, 4.12.10	3124233, 1.8.17	5665615, 4.1.29	6652520, 1.10.4	
996066, 4.12.10	3124248, 1.8.17	5665616, 4.1.29	6652521, 1.10.5	
996067, 1.2.20, 1.4.14	3124249, 1.8.17	5665617, 4.1.29	6652550, 1.10.18	
996067, 4.11.15, 4.12.11, 4.13.36	3124263, 1.8.17	5665618, 4.1.29	6652551, 1.10.18	
996078, 1.4.14	3124269, 1.8.17	5665619, 4.1.29	6652556, 1.10.20	
996082, 4.13.35	3124811, 1.8.18	5665621, 4.1.29	6652557, 1.10.20	
996083, 4.13.35	3124815, 1.8.18	5666100, 4.1.24	6652561, 1.10.21	
	3124832, 1.8.18	5666200, 4.1.25	6652571, 1.10.19	
	3124833, 1.8.18	5666201, 4.1.26	6652572, 1.10.10	
	3124871, 1.8.18	5667100, 4.1.29	6686306, 1.1.4	
	3124873, 1.8.18	5667101, 4.1.29	6686307, 1.1.4	
	3124875, 1.8.18	5667102, 4.1.29	6686308, 1.1.4	
	3858627, 4.1.30, 4.10.7, 4.11.15	5667103, 4.1.29	6686309, 1.1.4	
	5652701, 4.1.2	5667104, 4.1.29	6686310, 1.1.4	
	5660160, 4.1.22	5667105, 4.1.29	6686311, 1.1.4	
	5661160, 4.1.22	5667106, 4.1.29	6686326, 1.1.4	
	5665000, 4.1.28	5668100, 4.1.13	6686327, 1.1.4	
	5665001, 4.1.28	5676660, 4.1.21	6686340, 1.1.1	
	5665002, 4.1.28	6650140, 1.10.17	6686341, 1.1.1	
	5665003, 4.1.27	6652000, 1.9.4	6686342, 1.1.1	
	5665004, 4.1.28	6652001, 1.9.4	6686343, 1.1.1	
	5665100, 4.1.29	6652002, 1.9.4	6686345, 1.1.1	
	5665101, 4.1.29	6652003, 1.9.6	6686346, 1.1.1	
	5665102, 4.1.29	6652004, 1.9.7	6686347, 1.1.1	
	5665103, 4.1.29	6652005, 1.9.6	6686348, 1.1.1	
	5665105, 4.1.29	6652015, 1.9.4	6686349, 1.1.1	
	5665106, 4.1.29	6652030, 1.9.5	6686351, 1.1.1	
	5665110, 4.1.29	6652031, 1.9.8	6686360, 1.1.2	

Art.-No., page	Art.-No., page	Art.-No., page	Art.-No., page	Art.-No., page
12-digit Art.-No.	14-digit Art.-No.	17-digit Art.-No.	18-digit Art.-No.	
M1850-040601, 2.6.1	M1856-24080611, 2.6.2	MVT1820-062406021, 2.6.2	2000-68200-1100000, 1.8.6	2000-69300-2320000, 1.8.7
M1850-040602, 2.6.1	M1856-24080612, 2.6.2	MVT1820-062406022, 2.6.3	2000-68200-1320000, 1.8.6	2000-69300-2420000, 1.8.7
M1850-060601, 2.6.1		MVT1820-062406041, 2.6.2	2000-68200-2420000, 1.8.6	2000-69300-4300000, 1.8.7
M1850-060602, 2.6.1		MVT1820-062406042, 2.6.3	2000-68200-4300000, 1.8.6	2000-69300-4400000, 1.8.7
M1850-080601, 2.6.1		MVT1820-062406061, 2.6.2	2000-68200-4400000, 1.8.6	2000-69300-5200000, 1.8.7
M1850-080602, 2.6.1		MVT1820-062406062, 2.6.3	2000-68200-5320000, 1.8.6	2000-69300-7300000, 1.8.7
M1850-100601, 2.6.1		MVT1821-062406021, 2.6.2	2000-68200-5420000, 1.8.6	2000-69300-7400000, 1.8.7
M1850-100602, 2.6.2		MVT1821-062406022, 2.6.3	2000-68200-7400000, 1.8.6	2000-69400-2320000, 1.8.7
M1851-040601, 2.6.1		MVT1821-062406041, 2.6.2	2000-68300-1100000, 1.8.2	2000-69400-2420000, 1.8.7
M1851-040602, 2.6.1		MVT1821-062406042, 2.6.3	2000-68300-4300000, 1.8.2	2000-69400-4300000, 1.8.7
M1851-060601, 2.6.1		MVT1821-062406061, 2.6.2	2000-68300-4400000, 1.8.2	2000-69400-4400000, 1.8.7
M1851-060602, 2.6.1		MVT1821-062406062, 2.6.3	2000-68400-2010000, 1.8.8	2000-69400-5320000, 1.8.7
M1851-080601, 2.6.1		MVT1825-262406041, 2.6.2	2000-68400-2320000, 1.8.8	2000-69400-5420000, 1.8.7
M1851-080602, 2.6.1		MVT1825-262406042, 2.6.3	2000-68400-2420000, 1.8.8	2000-69400-7300000, 1.8.7
M1851-100601, 2.6.1		MVT1825-262406061, 2.6.2	2000-68400-4300000, 1.8.8	2000-69400-7400000, 1.8.7
M1851-100602, 2.6.2		MVT1825-262406062, 2.6.3	2000-68400-4400000, 1.8.8	3000-16013-3100020, 1.9.1
			2000-68400-4410000, 1.8.8	3000-16013-3100025, 1.9.2
			2000-68400-5320000, 1.8.8	3000-16013-3100030, 1.9.2
			2000-68400-5420000, 1.8.8	3000-16013-3100040, 1.9.3
			2000-68400-7300000, 1.8.8	3000-16023-3100005, 1.9.1
			2000-68400-7400000, 1.8.8	3000-16023-3100022, 1.9.1
			2000-68400-7410000, 1.8.8	3000-16513-3100022, 1.9.2
			2000-68500-1100000, 1.8.8	3000-32512-2100040, 1.10.1
			2000-68500-2320000, 1.8.8	3000-33010-0000000, 1.9.29
			2000-68500-2420000, 1.8.8	3000-33113-1020012, 1.9.20
			2000-68500-2470000, 1.8.8	3000-33113-3020005, 1.9.22
			2000-68500-4300000, 1.8.8	3000-33113-3020012, 1.9.21
			2000-68500-4400000, 1.8.8	3000-33113-3020020, 1.9.23
			2000-68500-4410000, 1.8.8	3000-33113-3020025, 1.9.23
			2000-68500-5320000, 1.8.8	3000-33113-3020030, 1.9.25
			2000-68500-5420000, 1.8.8	3000-33113-3020050, 1.9.26
			2000-68500-7300000, 1.8.8	3000-33113-3020060, 1.9.24
			2000-68500-7400000, 1.8.8	3000-33113-3020065, 1.9.24
			2000-68500-7410000, 1.8.8	3000-33113-3020075, 1.9.27
			2000-68800-2300000, 1.8.5	3000-90000-0300010, 1.9.28
			2000-68800-2320000, 1.8.5	3000-90000-0300020, 1.9.28
			2000-68800-7300000, 1.8.5	4000-68000-0010000, 2.1.2
			2000-69000-2300000, 1.8.5	4000-68000-0020000, 2.1.2
			2000-69100-1100000, 1.8.2	4000-68000-0050000, 2.1.2
			2000-69100-2420000, 1.8.2	4000-68000-0060000, 2.1.3
			2000-69100-4300000, 1.8.2	4000-68000-0070000, 2.1.3
			2000-69100-4400000, 1.8.2	4000-68000-0090000, 2.1.4
			2000-69100-5420000, 1.8.2	4000-68000-0120000, 2.1.3
			2000-69100-7300000, 1.8.2	4000-68000-0160000, 2.1.2
			2000-69100-7400000, 1.8.2	4000-68000-0170000, 2.1.3
			2000-69101-2320000, 1.8.2	4000-68000-0180000, 2.1.3
			2000-69101-4300000, 1.8.2	4000-68000-0190000, 2.1.3
			2000-69200-1100000, 1.8.2	4000-68000-0820000, 2.1.5
			2000-69200-2320000, 1.8.2	4000-68000-0900000, 2.1.8
			2000-69200-2420000, 1.8.2	4000-68000-0910000, 2.1.5
			2000-69200-4300000, 1.8.2	4000-68000-0920000, 2.1.8
			2000-69200-4400000, 1.8.2	4000-68000-0930000, 2.1.8
			2000-69200-5420000, 1.8.2	4000-68000-0940000, 2.1.5
			2000-69200-7400000, 1.8.2	4000-68000-0950000, 2.1.8
			2000-69300-1100000, 1.8.7	4000-68000-0960000, 2.1.5

# INDEX

Art.-No., page	Art.-No., page	Art.-No., page	Art.-No., page	Art.-No., page
4000-68000-0970000, 2.1.5	4000-68000-4550001, 2.1.11	4000-68523-0000001, 2.1.1	4000-70403-0100240, 2.2.4	4000-75070-0000920, 2.4.4
4000-68000-0990000, 2.1.5	4000-68000-4570000, 2.1.11	4000-68523-0000003, 2.1.1	4000-70403-0100250, 2.2.4	4000-75070-0000921, 2.4.4
4000-68000-1040000, 2.1.5	4000-68000-4570001, 2.1.11	4000-68524-0000001, 2.1.1	4000-70403-0100260, 2.2.4	4000-75070-0000922, 2.4.5
4000-68000-1110000, 2.1.6	4000-68000-4580000, 2.1.11	4000-68524-0000003, 2.1.1	4000-70403-0100270, 2.2.4	4000-75324-5310000, 2.4.2
4000-68000-1200000, 2.1.6	4000-68000-4580001, 2.1.11	4000-69000-1000000, 2.2.1	4000-70403-0100280, 2.2.4	4000-75330-5310000, 2.4.2
4000-68000-1210000, 2.1.6	4000-68000-4610000, 2.1.12	4000-69000-1040000, 2.2.1	4000-70403-0100290, 2.2.4	4000-75800-0000900, 2.4.6
4000-68000-1220000, 2.1.6	4000-68000-4610001, 2.1.12	4000-69000-1050000, 2.2.1	4000-70403-0100300, 2.2.4	4000-75800-1715004, 2.4.5
4000-68000-1280000, 2.1.8	4000-68000-4610004, 2.1.12	4000-69000-1060000, 2.2.1	4000-70503-0001010, 2.2.4	4000-75800-1715008, 2.4.5
4000-68000-1300000, 2.1.8	4000-68000-4620001, 2.1.9	4000-69000-1080000, 2.2.1	4000-70503-0001020, 2.2.4	4000-75800-1715016, 2.4.5
4000-68000-1310000, 2.1.6	4000-68000-8500000, 2.1.17	4000-69000-1090000, 2.2.2	4000-70503-0001030, 2.2.4	4000-75800-1715024, 2.4.5
4000-68000-1400000, 2.1.8	4000-68000-8510000, 2.1.17	4000-69000-1100000, 2.2.2	4000-70503-0001050, 2.2.4	4000-75800-1715032, 2.4.5
4000-68000-1410000, 2.1.6	4000-68000-8900000, 2.1.16	4000-69000-2000000, 2.2.2	4000-70503-0001060, 2.2.4	4000-75801-1415006, 2.4.5
4000-68000-1420000, 2.1.6	4000-68000-8910000, 2.1.16	4000-69000-2040000, 2.2.2	4000-70503-0100010, 2.2.4	4000-75801-1415012, 2.4.5
4000-68000-1430000, 2.1.7	4000-68000-9000000, 2.1.17	4000-69000-2500000, 2.2.2	4000-70503-0100020, 2.2.4	4000-75801-1415018, 2.4.5
4000-68000-1440000, 2.1.7	4000-68000-9030010, 2.1.16	4000-69000-5200000, 2.2.2	4000-70603-0240120, 2.2.4	4000-75801-1415024, 2.4.5
4000-68000-1450000, 2.1.7	4000-68000-9030011, 2.1.16	4000-69000-9000000, 2.2.2	4000-70603-0240140, 2.2.4	4000-75827-1315000, 2.4.6
4000-68000-1620000, 2.1.7	4000-68000-9030020, 2.1.16	4000-69000-9500050, 2.2.3	4000-70603-0240170, 2.2.4	4000-75900-1715004, 2.4.5
4000-68000-1700000, 2.1.7	4000-68000-9030021, 2.1.16	4000-69000-9500060, 2.2.3	4000-70603-0240220, 2.2.4	4000-75900-1715008, 2.4.5
4000-68000-1800000, 2.1.7	4000-68000-9030040, 2.1.16	4000-69112-0000000, 2.2.1	4000-70603-0240230, 2.2.4	4000-75900-1715016, 2.4.5
4000-68000-1810000, 2.1.7	4000-68000-9030041, 2.1.16	4000-69122-0000000, 2.2.1	4000-70603-0240290, 2.2.4	4000-75900-1715024, 2.4.5
4000-68000-3010000, 2.1.2	4000-68000-9030050, 2.1.16	4000-69212-0000000, 2.2.1	4000-70703-0500040, 2.2.4	4000-75900-1715032, 2.4.5
4000-68000-3210000, 2.1.4	4000-68000-9030051, 2.1.16	4000-69222-0000000, 2.2.1	4000-70703-0500060, 2.2.4	4000-75901-1415006, 2.4.6
4000-68000-3220000, 2.1.2	4000-68000-9030052, 2.1.16	4000-70103-0004000, 2.2.3	4000-70703-0500080, 2.2.4	4000-75901-1415012, 2.4.6
4000-68000-3240000, 2.1.2	4000-68000-9030053, 2.1.16	4000-70103-0008000, 2.2.3	4000-70703-0630080, 2.2.5	4000-75901-1415018, 2.4.6
4000-68000-3250000, 2.1.4	4000-68000-9030054, 2.1.16	4000-70103-0010000, 2.2.3	4000-70703-0630130, 2.2.5	4000-75901-1415024, 2.4.6
4000-68000-3280000, 2.1.3	4000-68000-9030055, 2.1.16	4000-70103-0104000, 2.2.3	4000-70703-0630190, 2.2.5	4000-76050-0000923, 2.4.5
4000-68000-3290000, 2.1.4	4000-68000-9030060, 2.1.16	4000-70103-0106000, 2.2.3	4000-70704-0500000, 2.2.4	4000-76050-1011000, 2.4.1
4000-68000-3310000, 2.1.4	4000-68000-9030061, 2.1.16	4000-70103-0202000, 2.2.3	4000-70704-0630000, 2.2.5	4000-76050-1012000, 2.4.1
4000-68000-4030000, 2.1.9	4000-68000-9030062, 2.1.16	4000-70202-0001000, 2.2.5	4000-70902-0075220, 2.2.5	4000-76050-1013000, 2.4.2
4000-68000-4040000, 2.1.10	4000-68000-9040010, 2.1.15	4000-70202-0002000, 2.2.5	4000-70902-0160450, 2.2.5	4000-76050-1014000, 2.4.2
4000-68000-4100000, 2.1.12	4000-68000-9040011, 2.1.15	4000-70203-0100000, 2.2.5	4000-70902-0180800, 2.2.5	4000-76050-1015000, 2.4.2
4000-68000-4110000, 2.1.13	4000-68000-9040012, 2.1.15	4000-70302-0000010, 2.2.5	4000-70920-0000000, 2.2.5	4000-76050-1100002, 2.4.1
4000-68000-4120000, 2.1.13	4000-68000-9040022, 2.1.15	4000-70302-0000050, 2.2.5	4000-71001-0410003, 4.12.10	4000-76050-1100003, 2.4.1
4000-68000-4130000, 2.1.13	4000-68000-9040030, 2.1.15	4000-70302-0000090, 2.2.5	4000-71001-0410004, 4.1.30, 4.4.17	4000-76050-1100004, 2.4.1
4000-68000-4140000, 2.1.13	4000-68000-9040031, 2.1.15	4000-70403-0001030, 2.2.4	4000-71001-0610004, 2.1.16	4000-76070-0000901, 2.4.4
4000-68000-4300001, 2.1.12	4000-68000-9040032, 2.1.15	4000-70403-0001040, 2.2.4	4000-71001-0620004, 2.1.16	4000-76070-0000902, 2.4.4
4000-68000-4310001, 2.1.12	4000-68000-9040040, 2.1.15	4000-70403-0001050, 2.2.4	4000-71001-0630004, 2.1.16	4000-76070-0000903, 2.4.4
4000-68000-4320001, 2.1.13	4000-68000-9040041, 2.1.15	4000-70403-0001060, 2.2.4	4000-71003-0101403, 4.12.10	4000-76070-0000913, 2.4.4
4000-68000-4330001, 2.1.13	4000-68000-9040042, 2.1.15	4000-70403-0001070, 2.2.4	4000-73000-0010000, 2.1.14	4000-76070-0000918, 2.4.4
4000-68000-4340001, 2.1.13	4000-68000-9040045, 2.1.15	4000-70403-0001080, 2.2.4	4000-73000-0150000, 2.1.14	4000-76070-0000923, 2.4.5
4000-68000-4360001, 2.1.13	4000-68000-9040050, 2.1.16	4000-70403-0001090, 2.2.4	4000-73000-0160000, 2.1.14	4000-76070-1011000, 2.4.1
4000-68000-4390001, 2.1.12	4000-68000-9040051, 2.1.16	4000-70403-0001100, 2.2.4	4000-73000-0170000, 2.1.14	4000-76070-1012000, 2.4.1
4000-68000-4500000, 2.1.9	4000-68000-9060010, 2.1.17	4000-70403-0001110, 2.2.4	4000-73000-0180000, 2.1.14	4000-76070-1013000, 2.4.2
4000-68000-4500001, 2.1.9	4000-68000-9060020, 2.1.17	4000-70403-0001120, 2.2.4	4000-75030-0000903, 2.4.4	4000-76070-1014000, 2.4.2
4000-68000-4500004, 2.1.9	4000-68000-9060030, 2.1.17	4000-70403-0001130, 2.2.4	4000-75057-1111000, 2.4.3	4000-76070-1015000, 2.4.2
4000-68000-4510000, 2.1.9	4000-68000-9140000, 2.1.17	4000-70403-0001140, 2.2.4	4000-75057-1112000, 2.4.3	4000-76070-1100002, 2.4.1
4000-68000-4510001, 2.1.9	4000-68000-9180000, 2.1.17	4000-70403-0001150, 2.2.4	4000-75057-1113000, 2.4.3	4000-76070-1100003, 2.4.1
4000-68000-4520000, 2.1.10	4000-68512-0000001, 2.1.1	4000-70403-0100160, 2.2.4	4000-75057-1114000, 2.4.3	4000-76070-1100004, 2.4.1
4000-68000-4520001, 2.1.10	4000-68512-0000003, 2.1.1	4000-70403-0100170, 2.2.4	4000-75057-1115000, 2.4.3	4000-76070-1300002, 2.4.1
4000-68000-4530000, 2.1.10	4000-68513-0000001, 2.1.1	4000-70403-0100180, 2.2.4	4000-75057-1311000, 2.4.3	4000-76070-1400002, 2.4.1
4000-68000-4530001, 2.1.10	4000-68513-0000003, 2.1.1	4000-70403-0100190, 2.2.4	4000-75057-1312000, 2.4.3	4000-76070-1500002, 2.4.1
4000-68000-4530004, 2.1.10	4000-68514-0000001, 2.1.1	4000-70403-0100200, 2.2.4	4000-75057-1313000, 2.4.3	4000-76501-5310000, 2.4.2
4000-68000-4540000, 2.1.11	4000-68514-0000003, 2.1.1	4000-70403-0100210, 2.2.4	4000-75057-1314000, 2.4.3	4000-76502-5310000, 2.4.2
4000-68000-4540001, 2.1.11	4000-68522-0000001, 2.1.1	4000-70403-0100220, 2.2.4	4000-75057-1315000, 2.4.3	4000-76704-5310000, 2.4.2
4000-68000-4550000, 2.1.10	4000-68522-0000003, 2.1.1	4000-70403-0100230, 2.2.4	4000-75070-0000904, 2.4.4	4000-76705-5310000, 2.4.2

Art.-No., page	Art.-No., page	Art.-No., page	Art.-No., page	Art.-No., page
4000-76712-5310000, 2.4.2	7000-12861-0000000, 3.2.51	7000-21161-0000000, 3.6.33	7000-41131-0000000, 3.3.3	7000-48116-0000000, 2.6.3
4000-76713-5310000, 2.4.2	7000-12881-0000000, 3.2.51, 3.6.32	7000-29001-0000000, 3.12.27	7000-41131-0000000, 4.10.3	7000-50061-0000000, 3.3.5, 3.10.34
5000-00501-1100000, 4.7.1	7000-12901-0000000, 3.2.47	7000-29005-0000000, 3.12.39	7000-41135-0000000, 3.3.3	7000-50061-0000000, 4.1.31
5000-00501-1110000, 4.7.1	7000-12921-0000000, 3.2.47	7000-29021-0000000, 3.12.27	7000-41141-0000000, 3.3.2	7000-50111-0000000, 3.10.34
5000-00501-1200000, 4.7.2	7000-12931-0000000, 3.2.52	7000-29041-0000000, 3.12.27	7000-41141-0000000, 4.10.2	7000-51521-0000000, 3.4.13
5000-00501-1210000, 4.7.2	7000-12941-0000000, 3.2.48	7000-29061-0000000, 3.12.27	7000-41151-0000000, 3.3.3	7000-51531-0000000, 3.6.33
5000-00501-1300001, 4.7.3	7000-12961-0000000, 3.2.48, 3.6.32	7000-29081-0000000, 3.12.28	7000-41151-0000000, 4.10.2	7000-51541-0000000, 3.6.33
5000-00501-2100000, 4.7.4	7000-12981-0000000, 3.2.50	7000-29085-0000000, 3.12.39	7000-41155-0000000, 4.4.18	7000-74001-0000000, 3.6.32
5000-00501-2110000, 4.7.4	7000-13001-0000000, 3.2.50	7000-29101-0000000, 3.12.28	7000-41161-0000000, 3.3.2	7000-74011-0000000, 3.6.32
5000-00501-2200000, 4.7.5	7000-13011-0000000, 3.2.52	7000-29121-0000000, 3.12.29	7000-41181-0000000, 3.3.2	7000-74021-0000000, 3.6.32
5000-00501-2210000, 4.7.5	7000-13021-0000000, 3.2.51	7000-29141-0000000, 3.12.29	7000-41191-0000000, 3.3.3	7000-74031-0000000, 3.6.32
5000-00501-2300001, 4.7.6	7000-13041-0000000, 3.2.51, 3.6.32	7000-29161-0000000, 3.12.29	7000-41301-0000000, 3.12.23	7000-74041-0000000, 3.6.34
7000-08331-0000000, 3.1.14	7000-13301-0000000, 3.2.54	7000-29165-0000000, 3.12.39	7000-41321-0000000, 3.12.24	7000-74061-0000000, 3.6.35
7000-08351-0000000, 3.1.14	7000-13321-0000000, 3.2.54	7000-29181-0000000, 3.12.29	7000-41421-0000000, 3.12.23	7000-74071-0000000, 3.6.32
7000-08371-0000000, 3.1.14	7000-13341-0000000, 3.2.56	7000-29241-0000000, 3.12.28	7000-41441-0000000, 3.12.24	7000-74075-0000000, 3.6.32
7000-08391-0000000, 3.1.14	7000-13361-0000000, 3.2.56	7000-29245-0000000, 3.12.36	7000-41901-0000000, 3.12.25	7000-74081-0000000, 3.6.32
7000-08552-9700020, 3.1.17	7000-13381-0000000, 3.2.54	7000-29261-0000000, 3.12.28	7000-41961-0000000, 3.12.25	7000-74085-0000000, 3.6.32
7000-08562-9690020, 3.1.17	7000-13401-0000000, 3.2.54	7000-29281-0000000, 3.12.31	7000-42021-0000000, 3.12.26	7000-74091-0000000, 3.6.32
7000-08571-9700020, 3.1.17	7000-13421-0000000, 3.2.56	7000-29301-0000000, 3.12.31	7000-42081-0000000, 3.12.26	7000-74095-0000000, 3.6.32
7000-08581-9710020, 3.1.17	7000-13441-0000000, 3.2.56	7000-29361-0000000, 3.12.32	7000-42111-0000000, 2.2.3	7000-78081-0000000, 3.10.31
7000-08601-0000000, 3.1.13	7000-13461-0000000, 3.6.33	7000-29381-0000000, 3.12.32	7000-42111-0000000, 3.4.12, 3.6.34	7000-78091-0000000, 3.10.33
7000-08611-0000000, 3.1.13	7000-13481-0000000, 4.1.30, 4.4.17	7000-29401-0000000, 3.12.32	7000-42114-0000000, 2.6.3	7000-78101-0000000, 3.10.31
7000-08621-0000000, 3.1.13	7000-13501-9710020, 3.2.58	7000-29405-0000000, 3.12.36	7000-42116-0000000, 2.6.3	7000-78141-0000000, 3.10.31
7000-08631-0000000, 3.1.13	7000-13521-9720020, 3.2.58, 3.6.34	7000-29421-0000000, 3.12.32	7000-42201-0000000, 4.12.11,	7000-78201-0000000, 3.10.32
7000-08641-0000000, 3.1.15	7000-13541-9710020, 3.2.58	7000-29441-0000000, 3.12.31	4.13.36	7000-78211-0000000, 3.10.33
7000-08651-0000000, 3.1.15	7000-13561-9720020, 3.2.58, 3.6.34	7000-29461-0000000, 3.12.31	7000-42211-0000000, 4.12.11,	7000-78221-0000000, 3.10.32
7000-08661-0000000, 3.1.15	7000-14001-0000000, 3.6.31	7000-29481-0000000, 3.12.30	4.13.36	7000-78261-0000000, 3.10.32
7000-08671-0000000, 3.1.15	7000-14011-0000000, 3.6.31	7000-29501-0000000, 3.12.30	7000-42251-0000000, 4.4.17	7000-78301-0000000, 3.6.33
7000-12461-0000000, 3.2.41	7000-14021-0000000, 3.6.31	7000-29521-0000000, 3.12.30	7000-42252-0000000, 4.4.17	7000-78341-9780020, 3.10.34
7000-12481-0000000, 3.2.41	7000-14031-0000000, 3.6.31	7000-29541-0000000, 3.12.30	7000-42771-0000000, 4.7.10	7000-78381-9780020, 3.10.34
7000-12491-0000000, 3.2.42	7000-14041-0000000, 3.6.33	7000-29561-0000000, 3.12.33	7000-44111-0000000, 2.2.3	7000-80081-0000000, 3.12.35
7000-12501-0000000, 3.2.45	7000-14121-9750020, 3.6.34	7000-29565-0000000, 3.12.40	7000-44111-0000000, 3.4.12, 3.6.34	7000-88521-0000000, 4.11.15
7000-12515-0000000, 3.2.45	7000-14161-9750020, 3.6.34	7000-29581-0000000, 3.12.33	7000-44114-0000000, 2.6.3	7000-88531-0000000, 4.11.15
7000-12521-0000000, 3.2.45	7000-14201-0000000, 3.6.31	7000-29601-0000000, 3.12.33	7000-44116-0000000, 2.6.3	7000-88602-0000000, 3.3.1
7000-12541-0000000, 3.2.43	7000-14221-0000000, 3.6.31	7000-29621-0000000, 3.12.33	7000-44151-0000000, 3.6.31	7000-88602-0000000, 4.11.15
7000-12561-0000000, 3.2.43	7000-14501-9760020, 3.6.34	7000-29645-0000000, 3.12.40	7000-44161-0000000, 3.6.31	7000-88611-0000000, 3.3.1
7000-12581-0000000, 3.2.41	7000-14521-0000000, 3.6.31	7000-29685-0000000, 3.12.40	7000-44586-0000000, 2.6.3	7000-88621-0000000, 3.3.1
7000-12601-0000000, 3.2.41	7000-14581-0000000, 3.6.31	7000-29765-0000000, 3.12.37	7000-44611-0000000, 2.2.3	7000-94081-0000000, 3.12.35
7000-12611-0000000, 3.2.42	7000-14621-0000000, 3.6.31	7000-29801-0000000, 3.12.34	7000-44611-0000000, 3.4.13, 3.6.34	7000-99001-0000000, 1.9.28,
7000-12621-0000000, 3.2.46	7000-15041-0000000, 3.6.33	7000-29805-0000000, 3.12.41	7000-44624-0000000, 2.6.3	1.10.24
7000-12641-0000000, 3.2.46	7000-15041-0000000, 4.1.31	7000-29821-0000000, 3.12.34	7000-44671-0000000, 3.6.33	7000-99001-0000000, 3.12.44
7000-12661-0000000, 3.2.43	7000-15701-0000000, 3.6.33	7000-29841-0000000, 3.12.34	7000-44681-0000000, 3.6.33	7000-99002-0000000, 3.1.16, 3.2.57,
7000-12671-0000000, 3.2.44	7000-15711-0000000, 3.6.34	7000-29861-0000000, 3.12.34	7000-46091-0000000, 4.1.30	3.5.7, 3.6.38, 3.7.22
7000-12681-0000000, 3.2.43	7000-17161-9730020, 3.2.58	7000-29885-0000000, 3.12.41	7000-46101-0000000, 3.6.31	7000-99003-0000000, 1.10.24
7000-12691-0000000, 3.2.44	7000-17181-9730020, 3.2.58	7000-29925-0000000, 3.12.41	7000-46101-0000000, 4.1.30	7000-99003-0000000, 3.12.44
7000-12701-0000000, 3.2.47	7000-17301-0000000, 3.2.49	7000-30005-0000000, 3.12.37	7000-46111-0000000, 2.2.3	7000-99004-0000000, 3.1.16, 3.2.57,
7000-12721-0000000, 3.2.47	7000-17311-0000000, 3.2.49	7000-30055-0000000, 3.12.38	7000-46111-0000000, 3.4.12, 3.6.34	3.5.7, 3.6.37, 3.7.22
7000-12731-0000000, 3.2.52	7000-17321-0000000, 3.2.49	7000-30105-0000000, 3.12.42	7000-46111-0000000, 4.1.31	7000-99005-0000000, 3.1.16, 3.2.57,
7000-12741-0000000, 3.2.48	7000-17331-0000000, 3.2.49	7000-30115-0000000, 3.12.42	7000-46114-0000000, 2.6.3	3.5.7, 3.6.38, 3.7.22
7000-12761-0000000, 3.2.48, 3.6.32	7000-17341-0000000, 3.2.55	7000-30125-0000000, 3.12.42	7000-46116-0000000, 2.6.3	7000-99006-0000000, 3.1.16, 3.2.57,
7000-12781-0000000, 3.2.53	7000-17351-0000000, 3.2.55	7000-30155-0000000, 3.12.38	7000-47281-0000000, 3.4.13	3.5.7, 3.6.38, 3.7.22
7000-12801-0000000, 3.2.53	7000-17361-0000000, 3.2.55	7000-30205-0000000, 3.12.43	7000-47301-0000000, 3.3.4	7000-99008-0000000, 3.1.16
7000-12821-0000000, 3.2.50	7000-17371-0000000, 3.2.55	7000-30215-0000000, 3.12.43	7000-47311-0000000, 3.3.4	7000-99011-0000000, 3.12.44
7000-12841-0000000, 3.2.50	7000-21101-0000000, 3.6.33	7000-41121-0000000, 3.3.2	7000-48111-0000000, 3.4.12	7000-99012-0000000, 3.12.44
7000-12851-0000000, 3.2.52	7000-21151-0000000, 3.6.33	7000-41121-0000000, 4.10.3	7000-48114-0000000, 2.6.3	7000-99013-0000000, 3.12.44



# INDEX

Art.-No., page	Art.-No., page	Art.-No., page	Art.-No., page	Art.-No., page
7000-99014-0000000, 3.12.44	7000-99221-0000000, 3.12.45	7000-C0201-5880000, 4.10.6	70MH-GSFHQ-B01D000, 2.7.3	70MH-RF045-0000000, 2.7.5
7000-99015-0000000, 3.12.44	7000-99231-0000000, 3.12.45	7000-C0201-7960000, 3.6.36	70MH-GSFHQ-B02D000, 2.7.3	70MH-RG06B-0000000, 2.7.5
7000-99016-0000000, 3.12.44	7000-99235-0000000, 3.12.45	7000-C0201-7980000, 3.6.36	70MH-GSGHQ-B01D000, 2.7.3	70MH-RG06S-0000000, 2.7.5
7000-99017-0000000, 3.12.44	7000-99241-0000000, 3.12.45	7000-C0201-8030000, 3.6.35	70MH-GSGHQ-B02D000, 2.7.3	70MH-ZRJ45-1000000, 2.7.10
7000-99018-0000000, 3.12.44	7000-99245-0000000, 3.12.45	7000-C0201-8400000, 3.6.35	70MH-GTDNL-A01B000, 2.7.1	70MH-ZRJ45-2000000, 2.7.10
7000-99019-0000000, 3.12.44	7000-99251-0000000, 3.12.44	7000-C0201-8620000, 3.6.36	70MH-GTDNL-A02B000, 2.7.1	8000-00000-3335000, 4.13.37
7000-99020-0000000, 3.12.44	7000-99255-0000000, 3.12.44	7000-C9901-1660000, 4.10.5	70MH-GTENQ-A01C000, 2.7.1	8000-00000-3345000, 4.11.15
7000-99021-0000000, 3.12.44	7000-99261-0000000, 3.12.44	7000-C9901-1780000, 4.10.5	70MH-GTENQ-A02C000, 2.7.1	8000-00000-3375000, 4.11.15
7000-99022-0000000, 3.12.44	7000-99271-0000000, 3.12.44	7000-C9901-7790000, 4.10.5	70MH-GTFHQ-A01D000, 2.7.1	8000-00000-3505000, 4.11.16
7000-99023-0000000, 3.12.44	7000-99281-0000000, 3.12.44	7000-C9901-7840000, 4.10.5	70MH-GTFHQ-A02D000, 2.7.1	8000-00000-3565000, 4.11.16
7000-99024-0000000, 3.12.44	7000-99291-0000000, 3.12.44	7000-P4391-0000000, 3.10.9	70MH-GTGHQ-A01D000, 2.7.1	8000-00000-3575000, 4.11.16
7000-99025-0000000, 3.12.44	7000-99301-V011002, 3.1.16, 3.2.57, 3.5.7, 3.7.22	7000-P4421-0000000, 3.10.9	70MH-GTGHQ-A02D000, 2.7.2	8000-00000-3585000, 4.11.16
7000-99026-0000000, 3.12.44	7000-99301-V011018, 3.1.16, 3.2.57, 3.5.7, 3.7.22	7000-P6391-0000000, 3.10.7	70MH-MAA10-0000000, 2.7.5	8000-00000-3595000, 4.11.16
7000-99045-0000000, 3.2.57, 3.7.23	7000-99301-V012008, 3.1.16, 3.2.57, 3.5.7, 3.7.22	7000-P6411-0000000, 3.10.7	70MH-MAB1A-0020703, 2.7.6	8000-00000-3605000, 4.11.16
7000-99061-0000000, 4.7.10, 4.10.2, 4.10.3	7000-99301-V013020, 3.1.16, 3.2.57, 3.5.7, 3.7.22	7000-P7391-0000000, 3.10.8	70MH-MAB1A-0020706, 2.7.6	8000-00000-3625000, 4.13.37
7000-99062-0000000, 3.3.6	7000-99301-V014003, 3.1.16, 3.2.57, 3.5.7, 3.7.22	7000-P7411-0000000, 3.10.8	70MH-MAB1C-0030903, 2.7.7	8000-00000-3635000, 4.13.36
7000-99062-0000000, 4.7.10, 4.10.2, 4.10.3	7000-99301-V014006, 3.1.16, 3.2.57, 3.5.7, 3.7.22	7030-42291-0000000, 4.4.17	70MH-MAB1C-0040603, 2.7.7	8000-00000-3735000, 4.12.11
7000-99063-0000000, 3.3.6	7000-99301-V015005, 3.1.16, 3.2.57, 3.5.7, 3.7.22	7030-42602-0000000, 4.4.18	70MH-MAB1C-0060502, 2.7.8	8000-00000-3745000, 4.13.37
7000-99081-0000000, 3.1.16, 3.2.58, 3.5.7, 3.6.38, 3.7.23, 3.12.45	7000-99301-V016018, 3.1.16, 3.2.57, 3.5.7, 3.7.22	7030-42612-0000000, 4.4.18	70MH-MAB1C-0080402, 2.7.8	8000-00000-3845000, 4.11.16
7000-99091-0000000, 3.1.16	7000-99301-V017035, 3.1.16, 3.2.57, 3.5.7, 3.7.22	7030-42622-0000000, 2.5.2	70MH-MAB1C-0120801, 2.7.9	8000-00000-3855000, 4.11.16
7000-99091-0000000, 4.10.4	7000-99301-V019003, 3.1.16, 3.2.57, 3.5.7, 3.7.22	7050-12461-0000000, 3.5.5	70MH-MAB1C-0170201, 2.7.9	8000-00000-3865000, 4.11.16
7000-99094-0000000, 3.2.57, 3.7.22	7000-99301-V019004, 3.1.16, 3.2.57, 3.5.7, 3.7.22	7050-12481-0000000, 3.5.5	70MH-MAB1C-0200502, 2.7.9	8000-00000-3885000, 4.13.36
7000-99094-0000000, 4.10.3, 4.12.10, 4.13.35	7000-99401-0000000, 3.6.37	7050-12521-0000000, 3.5.6	70MH-MAB1P-0050402, 2.7.8	8000-00000-3895000, 4.11.16
7000-99096-0000000, 3.10.34	7000-99411-0000000, 3.6.37	7050-12581-0000000, 3.5.5	70MH-MAB2A-0010707, 2.7.6	8000-00000-3955000, 4.11.16
7000-99096-0000000, 4.10.4	7000-99421-0000000, 3.6.37	7050-12601-0000000, 3.5.5	70MH-MAB2A-0020704, 2.7.6	8000-00000-3965000, 4.11.16
7000-99097-0000000, 3.10.34	7000-99431-0000000, 3.6.37	7050-12641-0000000, 3.5.6	70MH-MAC1A-0020703, 2.7.7	8000-00000-3985000, 4.13.36
7000-99097-0000000, 4.10.4	7000-99441-0000000, 3.6.37	7060-12221-8620100, 4.10.7	70MH-MAC1A-0020706, 2.7.7	8000-00000-4015000, 4.12.11
7000-99101-0000000, 3.1.16, 3.6.38, 3.7.22	7000-99441-0000000, 4.2.11, 4.3.14	7060-40005-5880100, 4.10.6	70MH-MAC1C-0030903, 2.7.7	8000-00000-4035000, 4.12.11, 4.13.37
7000-99101-0000000, 4.10.3, 4.11.15	7000-99591-0000000, 3.6.34	7060-40021-8620100, 4.10.6	70MH-MAC1C-0040603, 2.7.8	8000-00000-4045000, 4.13.37
7000-99102-0000000, 3.2.57, 3.6.38, 3.7.22	7000-99601-0000000, 3.6.34	7060-40245-5880100, 4.10.6	70MH-MAC1C-0060502, 2.7.8	8000-00000-4050000, 4.13.37
7000-99102-0000000, 4.10.3, 4.12.10, 4.13.35	7000-99661-0000000, 3.6.35	7060-40261-8620100, 4.10.6	70MH-MAC1C-0080402, 2.7.8	8000-00000-4115000, 4.11.16
7000-99103-0000000, 3.2.57, 3.7.22	7000-99671-0000000, 3.6.35	7060-40485-5420100, 4.10.7	70MH-MAC1C-0120801, 2.7.9	8000-00000-4125000, 4.11.16
7000-99103-0000000, 4.10.3, 4.12.10, 4.13.35	7000-99691-0000000, 3.6.35	7060-40505-4940100, 4.10.7	70MH-MAC1C-0170201, 2.7.9	8000-00000-4150000, 4.11.16
7000-99104-0000000, 3.10.34	7000-99701-0000000, 3.6.35	7060-42701-0000000, 3.6.31	70MH-MAC1C-0200502, 2.7.9	8000-00000-4170000, 4.13.37
7000-99104-0000000, 4.10.4	7000-99801-0000000, 3.1.17, 3.2.58, 3.7.23	7060-42701-0000000, 4.10.6	70MH-MAC1P-0050402, 2.7.8	8000-00000-4185000, 4.12.11, 4.13.37
7000-99105-0000000, 3.10.34	7000-99811-0000000, 3.2.58, 3.7.23	7060-42703-0000000, 4.10.6	70MH-MAC2A-0010707, 2.7.6	8000-00000-4250000, 4.12.11, 4.13.37
7000-99107-0000000, 3.7.22	7000-99901-0000000, 3.4.14	70MH-EB006-DP03020, 2.7.4	70MH-MAC2A-0020704, 2.7.7	8000-00000-5335000, 4.13.37
7000-99108-0000000, 3.7.22	7000-99911-0000000, 3.4.14	70MH-EB010-EP03020, 2.7.4	70MH-MAD2C-0020101, 2.7.7	8000-00000-5350000, 4.13.37
7000-99108-0000000, 4.10.3, 4.12.10, 4.13.35	7000-99921-0000000, 3.4.14	70MH-EB016-FP03020, 2.7.4	70MH-MAE2C-0020101, 2.7.7	8000-54520-0000000, 4.12.6
7000-99109-0000000, 3.2.57	7000-99931-0000000, 3.4.14	70MH-EB024-GP03020, 2.7.4	70MH-MAF2C-0020704, 2.7.7	8000-54522-0000000, 4.12.7
7000-99109-0000000, 4.10.3, 4.12.10, 4.13.35	7000-99951-0000000, 3.4.14	70MH-ES006-DP03020, 2.7.3	70MH-MAG2C-0020704, 2.7.7	8000-54722-0000000, 4.12.9
7000-99201-0000000, 3.12.45	7000-C0201-5880000, 3.6.36	70MH-ES010-EP03020, 2.7.4	70MH-MAH1C-0000000, 2.7.9	8000-58520-0000000, 4.12.6
7000-99205-0000000, 3.12.45		70MH-ES016-FP03020, 2.7.4	70MH-MAL1C-0000000, 2.7.10	8000-58522-0000000, 4.12.7
7000-99211-0000000, 3.12.45		70MH-ES024-GP03020, 2.7.4	70MH-MAL10-0000000, 2.7.10	8000-80000-0000000, 4.11.5
		70MH-GADNL-B000000, 2.7.2	70MH-MAM10-0000000, 2.7.10	8000-80001-0000000, 4.11.6
		70MH-GAENQ-B000000, 2.7.2	70MH-MAP10-0020000, 2.7.10	8000-80060-0000000, 4.11.13
		70MH-GAGNQ-B000000, 2.7.2	70MH-MAP10-0030000, 2.7.10	8000-80949-0000000, 4.11.10, 4.11.15
		70MH-GKENQ-B01C000, 2.7.3	70MH-MAQ2A-0010707, 2.7.6	8000-84000-0000000, 4.11.5
		70MH-GKFNQ-B01D000, 2.7.3	70MH-MAR2A-0010707, 2.7.6	8000-84001-0000000, 4.11.6
		70MH-GKGHQ-B01D000, 2.7.3	70MH-RD02B-0000000, 2.7.5	8000-84060-0000000, 4.11.13
		70MH-GSDNL-B01B000, 2.7.2	70MH-RD02S-0000000, 2.7.5	8000-84070-0000000, 4.11.12
		70MH-GSDNL-B02B000, 2.7.2	70MH-RE03B-0000000, 2.7.5	8000-84100-0000000, 4.11.7
		70MH-GSEHQ-B02C000, 2.7.2	70MH-RE03S-0000000, 2.7.5	8000-84160-0000000, 4.11.14
		70MH-GSENG-B01C000, 2.7.2	70MH-RF04B-0000000, 2.7.5	8000-84400-0000000, 4.13.8

Art.-No., page	Art.-No., page	Art.-No., page	Art.-No., page	Art.-No., page
8000-84401-0000000, 4.13.9	9000-41000-0000000, 1.4.14	Form without cable type and length	7000-12421, 3.2.15	7000-19301, 3.2.19
8000-84402-0000000, 4.13.10	9000-41000-0000001, 1.4.14		7000-12441, 3.2.16	7000-19321, 3.2.22
8000-84440-0000000, 4.13.17	9000-41000-0000002, 1.4.14		7000-13061, 3.2.17	7000-19341, 3.2.25
8000-84450-0000000, 4.13.17	9000-41000-0000006, 1.4.14		7000-13081, 3.2.17	7000-19361, 3.2.28
8000-84451-0000000, 4.13.17	9000-41000-0000212, 1.4.1		7000-13101, 3.2.17	7000-21001, 3.6.15
8000-84452-0000000, 4.13.18	9000-41000-0002206, 1.4.1		7000-13105, 3.6.4	7000-21021, 3.6.15
8000-84470-0000000, 4.13.27	9000-41011-0200000, 1.4.2		7000-13121, 3.2.20	7000-23051, 3.9.1
8000-84500-0000000, 4.13.11	9000-41011-0400000, 1.4.2		7000-13125, 3.6.4	7000-23151, 3.9.1
8000-84501-0000000, 4.13.12	9000-41011-0600000, 1.4.2		7000-13141, 3.2.20	7000-23251, 3.9.2
8000-84502-0000000, 4.13.13	9000-41011-0800000, 1.4.2		7000-13161, 3.2.20	7000-23351, 3.9.3
8000-84520-0000000, 4.13.29	9000-41011-1000000, 1.4.2		7000-13181, 3.2.23	7000-23711, 3.9.4
8000-84530-0000000, 4.13.28	9000-41011-1600000, 1.4.2		7000-13201, 3.2.23	7000-23751, 3.9.4
8000-84540-0000000, 4.13.19	9000-41012-0200000, 1.4.2		7000-13221, 3.2.23	7000-40001, 3.2.29
8000-84550-0000000, 4.13.19	9000-41012-0400000, 1.4.2		7000-13225, 3.6.5	7000-40021, 3.2.29
8000-84551-0000000, 4.13.20	9000-41012-0600000, 1.4.2		7000-13241, 3.2.26	7000-40041, 3.2.29
8000-84552-0000000, 4.13.20	9000-41014-0200000, 1.4.2		7000-13251, 3.6.5	7000-40101, 3.2.32
8000-84560-0000000, 4.13.27	9000-41014-0400000, 1.4.2		7000-13261, 3.2.26	7000-40121, 3.2.32
8000-84949-0000000, 4.11.10, 4.11.15	9000-41014-0600000, 1.4.2		7000-13281, 3.2.26	7000-40141, 3.2.32
8000-86000-0000000, 4.11.5	9000-41034-0000001, 1.4.14		7000-13501, 3.4.2	7000-40321, 3.2.33
8000-86001-0000000, 4.11.6	9000-41034-0000002, 1.4.14		7000-13521, 3.4.2	7000-40341, 3.2.33
8000-86060-0000000, 4.11.13	9000-41034-0000003, 1.4.14		7000-13541, 3.4.3	7000-40361, 3.2.33
8000-86070-0000000, 4.11.12	9000-41034-0100400, 1.4.6		7000-13561, 3.4.3	7000-40381, 3.2.34
8000-86100-0000000, 4.11.7	9000-41034-0100600, 1.4.7		7000-14051, 3.6.1	7000-40481, 3.2.38
8000-88000-0000000, 4.11.5	9000-41034-0101000, 1.4.9		7000-14061, 3.6.2	7000-40501, 3.2.38
8000-88001-0000000, 4.11.6	9000-41034-0401000, 1.4.8	7000-14071, 3.6.2	7000-40521, 3.2.38	
8000-88060-0000000, 4.11.13	9000-41034-0401005, 1.4.9	7000-14081, 3.6.1	7000-40531, 3.6.6	
8000-88100-0000000, 4.11.7	9000-41042-0100400, 1.4.6	7000-14541, 3.6.12	7000-40551, 3.6.6	
8000-88400-0000000, 4.13.8	9000-41042-0100600, 1.4.7	7000-14561, 3.6.12	7000-40701, 3.2.35	
8000-88401-0000000, 4.13.9	9000-41042-0401000, 1.4.8	7000-15001, 3.6.28	7000-40721, 3.2.35	
8000-88402-0000000, 4.13.10	9000-41064-0200000, 1.4.11	7000-15021, 3.6.28	7000-40741, 3.2.36	
8000-88430-0000000, 4.13.28	9000-41064-0400000, 1.4.11	7000-15501, 3.6.13	7000-40761, 3.2.36	
8000-88440-0000000, 4.13.21	9000-41064-0600000, 1.4.11	7000-15521, 3.6.14	7000-40781, 3.2.37	
8000-88450-0000000, 4.13.21	9000-41068-0200000, 1.4.10	7000-15551, 3.6.13	7000-40801, 3.2.37	
8000-88451-0000000, 4.13.22	9000-41068-0200600, 1.4.12	7000-15571, 3.6.14	7000-40881, 3.12.19	
8000-88452-0000000, 4.13.22	9000-41068-0400000, 1.4.10	7000-17001, 3.2.2	7000-40921, 3.12.20	
8000-88460-0000000, 4.13.27	9000-41068-0600000, 1.4.10	7000-17021, 3.2.5	7000-40931, 3.12.20	
8000-88500-0000000, 4.13.11	9000-41078-0000002, 1.4.14	7000-17041, 3.2.8	7000-40961, 3.12.21	
8000-88501-0000000, 4.13.12	9000-41078-0000004, 1.4.14	7000-17061, 3.2.11	7000-41001, 3.12.21	
8000-88502-0000000, 4.13.13	9000-41078-0000006, 1.4.14	7000-17081, 3.2.18	7000-41041, 3.12.22	
8000-88520-0000000, 4.13.29	9000-41078-0000010, 1.4.14	7000-17101, 3.2.21	7000-41081, 3.12.22	
8000-88540-0000000, 4.13.23	9000-41078-0600001, 1.4.13	7000-17121, 3.2.24	7000-41501, 3.12.17	
8000-88549-0000000, 4.13.16	9000-41078-0600002, 1.4.13	7000-17141, 3.2.27	7000-41521, 3.12.17	
8000-88550-0000000, 4.13.23	9000-41084-0100400, 1.4.4	7000-17161, 3.4.2	7000-41541, 3.12.17	
8000-88551-0000000, 4.13.24	9000-41084-0100600, 1.4.4	7000-17181, 3.4.3	7000-41561, 3.12.18	
8000-88552-0000000, 4.13.24	9000-41084-0401000, 1.4.5	7000-18001, 3.12.1	7000-41581, 3.12.18	
8000-88559-0000000, 4.13.16	9000-41091-0101000, 1.4.3	7000-18021, 3.12.1	7000-41601, 3.12.18	
8000-88580-0000000, 4.13.25	9000-41091-1102000, 1.4.3	7000-18041, 3.12.1	7000-44001, 3.6.3	
8000-88590-0000000, 4.13.26	9000-41092-0101000, 1.4.3	7000-18061, 3.12.2	7000-44021, 3.6.3	
8000-88680-0000000, 4.13.25	9000-41094-0101000, 1.4.3	7000-18081, 3.12.2	7000-44511, 3.6.16	
8000-88690-0000000, 4.13.26	9000-41190-0000000, 1.4.1	7000-18121, 3.12.3	7000-44561, 3.6.16	
8000-98700-0000000, 4.13.32		7000-18141, 3.12.3	7000-44711, 3.6.17	
8000-98790-0000000, 4.13.34		7000-19001, 3.2.3	7000-44731, 3.6.17	
9000-11112-1962020, 1.2.8		7000-19021, 3.2.6	7000-46041, 3.6.29	
9000-11112-2062020, 1.2.8		7000-19041, 3.2.9	7000-46061, 3.6.29	
		7000-19061, 3.2.12	7000-47001, 3.6.18	

# INDEX

Art.-No., page	Art.-No., page	Art.-No., page	Art.-No., page	Art.-No., page
7000-47021, 3.6.18	7000-88041, 3.1.8	7000-P8281, 3.4.10	7072-70061, 3.8.1	7700-48551, 3.11.29
7000-47051, 3.6.18	7000-89401, 3.6.11	7000-P8291, 3.4.11	7072-70301, 3.8.2	7700-48561, 3.11.27
7000-48001, 3.2.30	7000-89431, 3.6.11	7000-P8301, 3.10.19	7072-70321, 3.8.2	7700-48571, 3.11.28
7000-48041, 3.2.39	7000-89501, 3.1.11	7000-P8321, 3.10.19	7072-70361, 3.8.2	7700-48851, 3.11.30
7000-50021, 3.10.30	7000-89511, 3.1.11	7000-P8331, 3.10.22	7072-72011, 3.8.3	7700-51001, 3.11.32
7000-50051, 3.10.30	7000-89521, 3.1.16	7000-P8332, 3.10.22	7072-72081, 3.8.3	7700-51011, 3.11.32
7000-51001, 3.6.19	7000-89531, 3.1.16	7000-P8341, 3.10.28	7072-72161, 3.8.4	7700-51021, 3.11.33
7000-51021, 3.6.19	7000-89701, 3.6.8	7000-P8381, 3.4.10	7072-72191, 3.8.5	7700-51101, 3.11.34
7000-51101, 3.6.20	7000-89721, 3.6.9	7000-P8391, 3.4.11	7072-72221, 3.8.4	7700-51201, 3.11.34
7000-51551, 3.6.20	7000-89771, 3.6.8	7014-12221, 3.7.10	7072-72301, 3.8.6	7700-51551, 3.11.35
7000-53001, 3.2.31	7000-89781, 3.6.9	7014-12341, 3.7.10	7072-72381, 3.8.6	7700-74101, 3.11.12
7000-53301, 3.2.40	7000-94001, 3.12.10	7014-12421, 3.7.11	7072-72461, 3.8.7	7700-74118, 3.11.16
7000-58001, 3.12.12	7000-94021, 3.12.10	7014-13221, 3.7.12	7072-72521, 3.8.7	7700-74301, 3.11.25
7000-58021, 3.12.12	7000-94041, 3.12.11	7014-13281, 3.7.12	7072-73001, 3.8.8	7700-74315, 3.11.35
7000-58041, 3.12.12	7000-94061, 3.12.11	7014-40021, 3.7.13	7072-73081, 3.8.8	7700-74718, 3.11.31
7000-58101, 3.12.14	7000-99621, 3.6.27	7014-40121, 3.7.13	7072-73161, 3.8.9	7700-A3001, 3.11.36
7000-58121, 3.12.14	7000-99641, 3.6.27	7014-40341, 3.7.14	7072-73221, 3.8.9	7700-A3011, 3.11.39
7000-58141, 3.12.14	7000-P3201, 3.10.1	7024-12001, 3.7.1	7072-73301, 3.8.10	7700-A3021, 3.11.42
7000-58201, 3.12.13	7000-P3221, 3.10.2	7024-12021, 3.7.2	7072-73381, 3.8.10	7700-A3031, 3.11.45
7000-58221, 3.12.13	7000-P3241, 3.10.5	7024-12041, 3.7.3	7072-73461, 3.8.11	7700-A3A01, 3.11.48
7000-58241, 3.12.13	7000-P4201, 3.10.1	7024-12081, 3.7.1	7072-73521, 3.8.11	7700-A3A31, 3.11.49
7000-58401, 3.12.15	7000-P4221, 3.10.2	7024-12101, 3.7.2	7700-12021, 3.11.1	7700-A4001, 3.11.37
7000-58411, 3.12.15	7000-P4241, 3.10.5	7024-12121, 3.7.3	7700-12041, 3.11.2	7700-A4011, 3.11.40
7000-58421, 3.12.15	7000-P4281, 3.4.5	7024-12181, 3.7.4	7700-12101, 3.11.1	7700-A4021, 3.11.43
7000-58431, 3.12.16	7000-P4291, 3.4.5	7024-12221, 3.7.5	7700-12121, 3.11.2	7700-A4031, 3.11.46
7000-58441, 3.12.16	7000-P6201, 3.10.3	7024-12241, 3.7.6	7700-12221, 3.11.3	7700-A4A01, 3.11.50
7000-58451, 3.12.16	7000-P6221, 3.10.4	7024-12321, 3.7.4	7700-12241, 3.11.4	7700-A4A31, 3.11.51
7000-74101, 3.6.21	7000-P6241, 3.10.6	7024-12341, 3.7.5	7700-12341, 3.11.3	7700-A5001, 3.11.38
7000-74121, 3.6.21	7000-P6281, 3.4.6	7024-12361, 3.7.6	7700-12361, 3.11.4	7700-A5011, 3.11.41
7000-74141, 3.6.21	7000-P6291, 3.4.6	7024-12441, 3.7.7	7700-14511, 3.11.11	7700-A5021, 3.11.44
7000-74161, 3.6.22	7000-P7201, 3.10.3	7024-40001, 3.7.8	7700-14541, 3.11.9	7700-A5031, 3.11.47
7000-74181, 3.6.22	7000-P7221, 3.10.4	7024-40021, 3.7.8	7700-14561, 3.11.10	7700-A5A01, 3.11.52
7000-74301, 3.6.23	7000-P7241, 3.10.6	7024-40041, 3.7.9	7700-17511, 3.11.15	7700-A5A31, 3.11.53
7000-74311, 3.6.24	7000-P7281, 3.4.7	7024-40281, 3.7.9	7700-17541, 3.11.13	8000-54510, 4.12.1
7000-74521, 3.6.23	7000-P7291, 3.4.7	7044-12021, 3.7.15	7700-17561, 3.11.13	8000-54512, 4.12.2
7000-74601, 3.6.26	7000-P8001, 3.10.20	7044-12101, 3.7.15	7700-17581, 3.11.14	8000-54513, 4.12.5
7000-74641, 3.6.26	7000-P8021, 3.10.21	7044-12221, 3.7.16	7700-40021, 3.11.5	8000-54515, 4.12.4
7000-74701, 3.6.25	7000-P8031, 3.10.23	7044-12241, 3.7.16	7700-40041, 3.11.7	8000-54712, 4.12.8
7000-74711, 3.6.25	7000-P8032, 3.10.24	7044-12292, 3.7.18	7700-40121, 3.11.5	8000-58510, 4.12.1
7000-78021, 3.10.29	7000-P8041, 3.10.27	7044-12341, 3.7.17	7700-40141, 3.11.7	8000-58511, 4.12.3
7000-78051, 3.10.29	7000-P8081, 3.4.8	7044-40021, 3.7.19	7700-40201, 3.11.6	8000-58512, 4.12.3
7000-78341, 3.4.4	7000-P8091, 3.4.9	7044-40121, 3.7.19	7700-40221, 3.11.8	8000-58513, 4.12.5
7000-78381, 3.4.4	7000-P8101, 3.10.10	7044-40201, 3.7.20	7700-40261, 3.11.6	8000-58515, 4.12.4
7000-80001, 3.12.8	7000-P8121, 3.10.11	7044-40261, 3.7.20	7700-40281, 3.11.8	8000-58610, 4.12.2
7000-80021, 3.12.8	7000-P8131, 3.10.14	7044-40312, 3.7.21	7700-44511, 3.11.17	8000-80010, 4.11.1
7000-80041, 3.12.9	7000-P8132, 3.10.15	7050-12221, 3.5.1	7700-44541, 3.11.18	8000-80011, 4.11.2
7000-80061, 3.12.9	7000-P8141, 3.10.26	7050-12341, 3.5.1	7700-44561, 3.11.19	8000-80040, 4.11.11
7000-87001, 3.1.9	7000-P8181, 3.4.8	7050-12421, 3.5.2	7700-44571, 3.11.20	8000-80049, 4.11.8
7000-87011, 3.1.9	7000-P8191, 3.4.9	7050-40021, 3.5.3	7700-44711, 3.11.22	8000-80110, 4.11.3
7000-87061, 3.1.14	7000-P8201, 3.10.12	7050-40121, 3.5.3	7700-44761, 3.11.23	8000-80111, 4.11.4
7000-87251, 3.1.14	7000-P8211, 3.10.16	7050-40341, 3.5.4	7700-44811, 3.11.21	8000-84010, 4.11.1
7000-88001, 3.1.6	7000-P8221, 3.10.13	7060-40005, 3.6.30	7700-44851, 3.11.24	8000-84011, 4.11.2
7000-88011, 3.1.6	7000-P8231, 3.10.17	7060-40021, 3.6.30	7700-48511, 3.11.26	8000-84040, 4.11.11
7000-88021, 3.1.7	7000-P8232, 3.10.18	7072-70001, 3.8.1	7700-48521, 3.11.29	8000-84049, 4.11.8
7000-88031, 3.1.7	7000-P8241, 3.10.25	7072-70021, 3.8.1	7700-48541, 3.11.26	8000-84110, 4.11.3

Art.-No., page

8000-84111, 4.11.4				
8000-84149, 4.11.9				
8000-84410, 4.13.1				
8000-84411, 4.13.2				
8000-84412, 4.13.3				
8000-84459, 4.13.14				
8000-84510, 4.13.4				
8000-84511, 4.13.6				
8000-84512, 4.13.7				
8000-84559, 4.13.14				
8000-84659, 4.13.14				
8000-84712, 4.13.30				
8000-86010, 4.11.1				
8000-86011, 4.11.2				
8000-86040, 4.11.11				
8000-86049, 4.11.8				
8000-86110, 4.11.3				
8000-86111, 4.11.4				
8000-86149, 4.11.9				
8000-88010, 4.11.1				
8000-88011, 4.11.2				
8000-88040, 4.11.11				
8000-88049, 4.11.8				
8000-88110, 4.11.3				
8000-88111, 4.11.4				
8000-88149, 4.11.9				
8000-88410, 4.13.1				
8000-88411, 4.13.2				
8000-88412, 4.13.3				
8000-88459, 4.13.15				
8000-88510, 4.13.4				
8000-88511, 4.13.6				
8000-88512, 4.13.7				
8000-88559, 4.13.15				
8000-88659, 4.13.15				
8000-98710, 4.13.31				
8000-98749, 4.13.33				
8099-84510, 4.13.5				
8099-88510, 4.13.5				

**MURR**  
**ELEKTRONIK**

*stay connected*



➤ [www.murrelektronik.com](http://www.murrelektronik.com)



9800012

# Mouser Electronics

Authorized Distributor

Click to View Pricing, Inventory, Delivery & Lifecycle Information:

## Murrelektronik:

[7000-14541-7962100](#) [7000-14541-7966500](#) [7000-15551-8050150](#) [7000-17001-1140600](#) [7000-17001-2922500](#)  
[7000-17001-2950053](#) [7000-17001-6070300](#) [7000-17041-2070200](#) [7000-17041-2070300](#) [7000-17041-2082000](#) [7000-](#)  
[17041-2950100](#) [7000-17041-2950250](#) [7000-14541-7980150](#) [7000-14541-8000650](#) [7000-14561-7960750](#) [7000-](#)  
[15001-4140800](#) [7000-15021-4140200](#) [7000-15521-8050050](#) [7000-15521-8051000](#) [7000-17001-2920750](#) [7000-](#)  
[17001-7220300](#) [7000-17021-2921000](#) [7000-17041-2071000](#) [7000-17041-2921250](#) [7000-14541-7940200](#) [7000-](#)  
[14541-7961300](#) [7000-14561-7980300](#) [7000-15021-4141000](#) [7000-15501-8050400](#) [7000-15571-8310300](#) [7000-](#)  
[17001-2920220](#) [7000-17001-2921000](#) [7000-17001-6640300](#) [7000-17021-2950300](#) [7000-17041-2080600](#) [7000-](#)  
[17041-2923500](#) [7000-17041-6647000](#) [7000-17041-7220300](#) [7000-17041-7222500](#) [7000-14511-7940200](#) [7000-](#)  
[14541-7940600](#) [7000-14541-7948000](#) [7000-15001-4141000](#) [7000-15501-8311500](#) [7000-15521-8310200](#) [7000-](#)  
[15551-8310050](#) [7000-17021-6640300](#) [7000-17041-2951750](#) [7000-17041-6643500](#) [7000-17041-7220600](#) [7000-](#)  
[14511-7960150](#) [7000-14541-7960750](#) [7000-14541-7982000](#) [7000-14541-8001250](#) [7000-14561-8000800](#) [7000-](#)  
[15001-4140700](#) [7000-15551-8051500](#) [7000-17001-1141500](#) [7000-17041-2070040](#) [7000-17041-2920250](#) [7000-](#)  
[17041-3761500](#) [7000-17041-6080500](#) [7000-17041-7221200](#) [7000-15001-4141700](#) [7000-14541-7920150](#) [7000-](#)  
[14541-7940300](#) [7000-14541-7949900](#) [7000-14541-7961200](#) [7000-14561-7960300](#) [7000-15571-8051000](#) [7000-](#)  
[17001-2070750](#) [7000-17021-2920500](#) [7000-17021-2951500](#) [7000-17041-1143000](#) [7000-17041-6071000](#) [7000-](#)  
[14541-7964000](#) [7000-14541-8001000](#) [7000-15001-4140100](#) [7000-15551-8310100](#) [7000-15571-8310050](#) [7000-](#)  
[17001-2070400](#) [7000-17001-2920500](#) [7000-17001-6640500](#) [7000-17001-7180500](#) [7000-17021-2920150](#) [7000-](#)  
[17021-6640150](#) [7000-17041-2920120](#) [7000-17041-6644000](#) [7000-14541-7949000](#) [7000-14541-7960050](#) [7000-](#)  
[14561-7960200](#) [7000-14561-7960500](#) [7000-14561-8000750](#) [7000-15001-4140900](#) [7000-15501-8050050](#) [7000-](#)  
[15571-8050750](#) [7000-17001-2920700](#) [7000-17001-2950750](#) [7000-17021-2920300](#) [7000-17021-2951000](#)