

LUGS 24 FOR SIGNAL TRANSFER 250V/8 A

Mounting rail/pluggable spring clamps

Art.No.: 6654102

Weight: 0.137

Country of origin: CZ

Model designation: LUGS 24 FK

24-pole

Push-In spring clamp terminals

[Link to Product](#)

Illustration

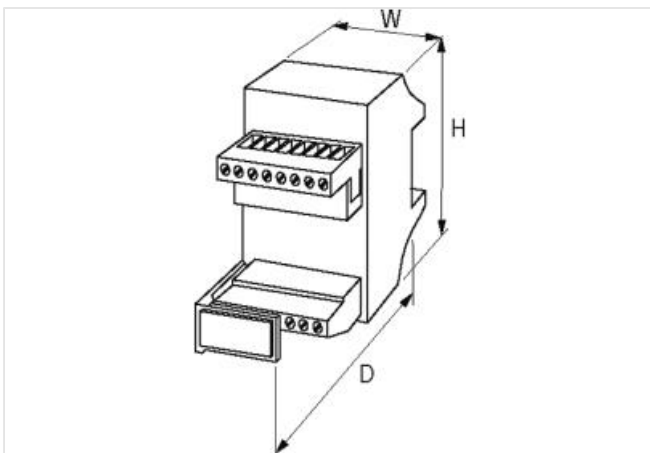
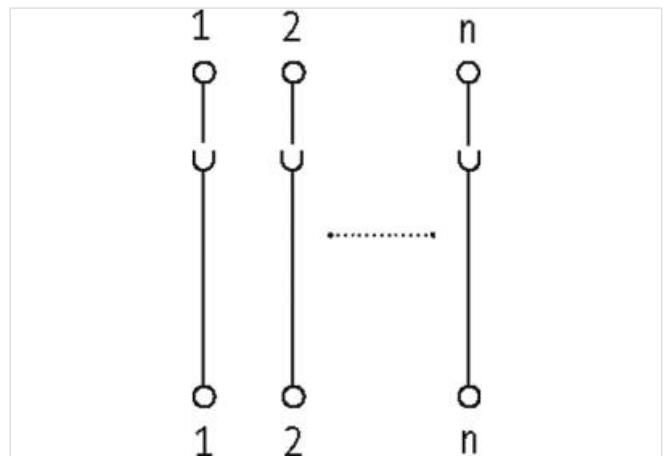

Product may differ from Image



Commercial data

ECLASS-6.0	27379201
ECLASS-6.1	27260708
ECLASS-7.0	27141152
ECLASS-8.0	27141152

ECLASS-9.0	27141152
ECLASS-10.1	27141152
ECLASS-11.1	27141152
ECLASS-12.0	27141152
ETIM-5.0	EC001283
customs tariff number	85369010
GTIN	4048879324137
Packaging unit	1

Electrical data | Supply

Operating voltage AC	250 V
Operating current max.	8 A

Installation

Connection cross section max.	2,5 mm ²
AWG number	14

Installation | Connection

Connection	Spring clamp plug-in terminals
------------	--------------------------------

Device protection | Electrical

Overvoltage category (EN 50178)	I
---------------------------------	---

Mechanical data | Mounting data

Mounting method	geschnappt
Suitable for mounting type	mounting rail, (EN 60715)
Height	75 mm
Width	70 mm
Depth	75 mm

Environmental characteristics | Climatic

Operating temperature min.	-20 °C
Operating temperature max.	60 °C

Mouser Electronics

Authorized Distributor

Click to View Pricing, Inventory, Delivery & Lifecycle Information:

[Murrelektronik:](#)

[6654102](#)