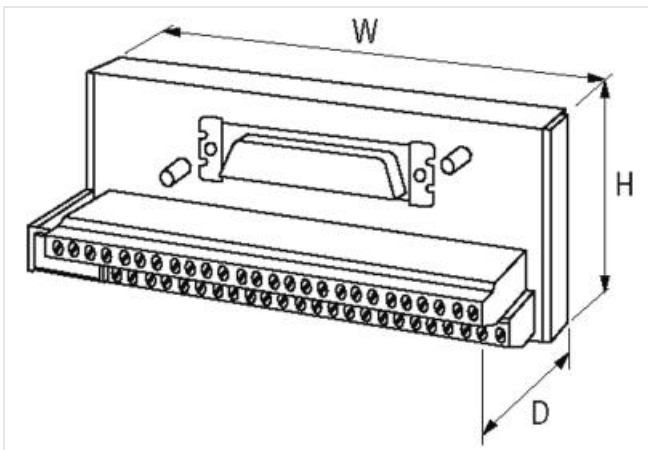
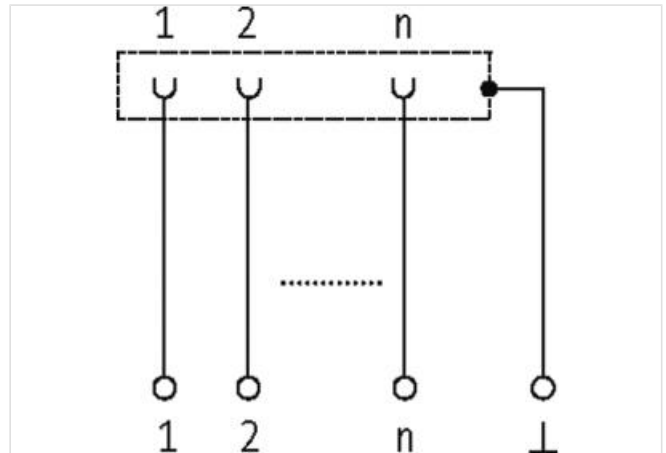

SV-SUB D 37ST.-KL FK

Art.No.: 6654033
 Weight: 0.172
 Country of origin: CZ
 Model designation: SV-SUB D 37St.-KL FK

Male connector
 37-pole
 Spring clamp terminals

[Link to Product](#)**Illustration**

Product may differ from Image

**Commercial data**

ECLASS-6.0	27379201
ECLASS-6.1	27260708
ECLASS-7.0	27141152
ECLASS-8.0	27141152
ECLASS-9.0	27141152

ECLASS-10.1	27141152
ECLASS-11.1	27141152
ECLASS-12.0	27141152
ETIM-5.0	EC001283
customs tariff number	85366990
GTIN	4048879021593
Packaging unit	1

Electrical data | Supply

Operating voltage AC	125 V
Operating voltage DC	150 V
Operating current max.	2 A

Device protection | Electrical

Overvoltage category (EN 60664-1)	II
-----------------------------------	----

Mechanical data | Mounting data

Mounting method	geschnappt
Suitable for mounting type	mounting rail, (EN 60715)
Height	63 mm
Width	75 mm
Depth	58 mm
Looking techniques	Standard UNC 4-40 screw thread bolt (EN 60807)

Environmental characteristics | Climatic

Operating temperature min.	-20 °C
Operating temperature max.	70 °C

Mouser Electronics

Authorized Distributor

Click to View Pricing, Inventory, Delivery & Lifecycle Information:

[Murrelektronik:](#)

[6654033](#)