

**PKJ8200 series DC-DC Converters**  
 Input 9-75 V, Output up to 16.7 A / 200 W

28701-BMR7148200 Rev B      October 2023  
 © Flex

### Key Features

- Ultra-wide input voltage range 8:1
- Industry standard case dimensions  
 61.0 \* 57.9 \* 12.7 mm (2.40 \* 2.28 \* 0.5 in)
- High Efficiency up to 91%
- 2250 Vdc input to output isolation
- EN50155 Compliant with External Circuits
- Meets safety requirements according to IEC/EN/UL 62368-1
- Shock & Vibration EN50155 (EN61373) Compliant
- Fire & Smoke EN45545-2 Compliant



### General Characteristics

- Input under voltage shutdown
- Remote control
- Output over voltage protection
- Over temperature protection
- Output short-circuit protection
- Output voltage adjust function
- ISO 9001/14001 certified supplier

### Safety Approvals



### Design for Environment



Meets requirements in high-temperature lead-free soldering processes.

### Contents

Ordering Information	2
General Information	2
Safety Specification	3
Absolute Maximum Ratings	4
Electrical Specification	
12 V, 16.7 A / 200W	PKJ8213PI(P)..... 6
24 V, 8.4 A / 200W	PKJ8216ZPI(P)..... 10
48 V, 4.2 A / 200W	PKJ8216JPI(P)..... 14
54 V, 3.7 A / 200W	PKJ8216HPI(P)..... 18
EMC Specification	22
Operating Information	23
Thermal Consideration	25
Connections	26
Mechanical Information	27
Soldering Information	29
Delivery Information	29
Product Qualification Specification	30

## Technical Specification

**PKJ8200 series DC-DC Converters**  
Input 9-75 V, Output up to 16.7 A / 200 W

28701-BMR7148200 Rev B      October 2023

© Flex

**Ordering Information**

Product program	Output
PKJ8213PI	12 V, 16.7 A / 200 W
PKJ8216ZPI	24 V, 8.4 A / 200 W
PKJ8216JPI	48 V, 4.2 A / 200 W
PKJ8216HPI	54 V, 3.7 A / 200 W

**Product number and Packaging**

PKJ821XXPI n <sub>1</sub>	
Options	n <sub>1</sub>
Remote Control logic	o

Options	Description
n <sub>1</sub>	Negative* P Positive

Example: a 12V output, positive logic module would be PKJ8213PIP.

The products are delivered in trays. See details in Delivery Package Information.

\* Standard variant (i.e., no option selected).

**General Information****Reliability**

The failure rate ( $\lambda$ ) and mean time between failures (MTBF =  $1/\lambda$ ) is calculated at max output power and an operating ambient temperature ( $T_A$ ) of +40°C. Flex Power Modules uses Telcordia SR-332 Issue 3 Method 1 to calculate the mean steady-state failure rate and standard deviation ( $\sigma$ ).

Telcordia SR-332 Issue 3 also provides techniques to estimate the upper confidence levels of failure rates based on the mean and standard deviation.

Mean steady-state failure rate, $\lambda$	Std. deviation, $\sigma$
254.10278 nFailures/h	12.3675 nFailures/h

MTBF (mean value) for the PKJ8200 series = 3.93 Mh.  
MTBF at 90% confidence level = 2.39 Mh

**Compatibility with RoHS requirements**

The products are compatible with the relevant clauses and requirements of the RoHS directive 2011/65/EU and have a maximum concentration value of 0.1% by weight in homogeneous materials for lead, mercury, hexavalent chromium, PBB and PBDE and of 0.01% by weight in homogeneous materials for cadmium.

Exemptions in the RoHS directive utilized in Flex products are found in the Statement of Compliance document.

Flex fulfills and will continuously fulfill all its obligations under regulation (EC) No 1907/2006 concerning the registration, evaluation, authorization and restriction of chemicals (REACH) as they enter into force and is through product materials declarations preparing for the obligations to communicate information on substances in the products.

**Quality Statement**

The products are designed and manufactured in an industrial environment where quality systems and methods like ISO 9000, Six Sigma, and SPC are intensively in use to boost the continuous improvements strategy. Infant mortality or early failures in the products are screened out and they are subjected to an ATE-based final test. Conservative design rules, design reviews and product qualifications, plus the high competence of an engaged work force, contribute to the high quality of the products.

**Warranty**

Warranty period and conditions are defined in Flex General Terms and Conditions of Sale.

**Limitation of Liability**

Flex does not make any other warranties, expressed or implied including any warranty of merchantability or fitness for a particular purpose (including, but not limited to, use in life support applications, where malfunctions of product can cause injury to a person's health or life).

**© Flex 2023**

The information and specifications in this technical specification is believed to be correct at the time of publication. However, no liability is accepted for inaccuracies, printing errors or for any consequences thereof. Flex reserves the right to change the contents of this technical specification at any time without prior notice.

## Technical Specification

**PKJ8200 series DC-DC Converters**  
Input 9-75 V, Output up to 16.7 A / 200 W

28701-BMR7148200 Rev B      October 2023

© Flex

## Safety Specification

### General information

Flex Power DC/DC converters and DC/DC regulators are designed in accordance with the safety standards IEC 62368-1, EN 62368-1 and UL 62368-1 *Audio/video, information and communication technology equipment - Part 1: Safety requirements*

IEC/EN/UL 62368-1 contains requirements to prevent injury or damage due to the following hazards:

- Electrical shock
- Electrically-caused fire
- Injury caused by hazardous substances
- Mechanically-caused injury
- Skin burn
- Radiation-caused injury

On-board DC/DC converters, Power interface modules and DC/DC regulators are defined as component power supplies. As components they cannot fully comply with the provisions of any safety requirements without “conditions of acceptability”. Clearance between conductors and between conductive parts of the component power supply and conductors on the board in the final product must meet the applicable safety requirements. Certain conditions of acceptability apply for component power supplies with limited stand-off (see Mechanical Information for further information). It is the responsibility of the installer to ensure that the final product housing these components complies with the requirements of all applicable safety standards and regulations for the final product.

Component power supplies for general use shall comply with the requirements in IEC/EN/UL 62368-1. Product related standards, e.g. IEEE 802.3af *Power over Ethernet*, and ETS-300132-2 *Power interface at the input to telecom equipment, operated by direct current (dc)* are based on IEC/EN/UL 62368-1 with regards to safety.

Flex Power DC/DC converters, Power interface modules and DC/DC regulators are UL 62368-1 recognized and certified in accordance with EN 62368-1. The flammability rating for all construction parts of the products meet requirements for V-0 class material according to IEC 60695-11-10, *Fire hazard testing, test flames – 50 W* horizontal and vertical flame test methods.

### Isolated DC/DC converters & Power interface modules

The product may provide basic or functional insulation between input and output according to IEC/EN/UL 62368-1 (see Safety Certificate), different conditions shall be met if the output of a basic or a functional insulated product shall be considered as ES1 energy source.

For basic insulated products (see Safety Certificate) the output is considered as ES1 energy source if one of the

following conditions is met:

- The input source provides supplementary or double or reinforced insulation from the AC mains according to IEC/EN/UL 62368-1.
- The input source provides functional or basic insulation from the AC mains and the product’s output is reliably connected to protective earth according to IEC/EN/UL 62368-1.

For functional insulated products (see Safety Certificate) the output is considered as ES1 energy source if one of the following conditions is met:

- The input source provides double or reinforced insulation from the AC mains according to IEC/EN/UL 62368-1.
- The input source provides basic or supplementary insulation from the AC mains and the product’s output is reliably connected to protective earth according to IEC/EN/UL 62368-1.
- The input source is reliably connected to protective earth and provides basic or supplementary insulation according to IEC/EN/UL 62368-1 and the maximum input source voltage is 60 Vdc.

Galvanic isolation between input and output is verified in an electric strength test and the isolation voltage ( $V_{iso}$ ) meets the voltage strength requirement for basic insulation according to IEC/EN/UL 62368-1.

It is recommended to use a slow blow fuse at the input of each DC/DC converter. If an input filter is used in the circuit the fuse should be placed in front of the input filter. In the rare event of a component problem that imposes a short circuit on the input source, this fuse will provide the following functions:

- Isolate the fault from the input power source so as not to affect the operation of other parts of the system
- Protect the distribution wiring from excessive current and power loss thus preventing hazardous overheating

Technical Specification

<b>PKJ8200 series DC-DC Converters</b> Input 9-75 V, Output up to 16.7 A / 200 W	28701-BMR7148200 Rev B	October 2023
	© Flex	

Absolute Maximum Ratings

Characteristics		min	typ	max	Unit
$T_{P1}$	Operating Temperature (see Thermal Consideration section)	-40		+110	°C
$T_S$	Storage temperature	-55		+125	°C
$V_I$	Input voltage	9		75	V
$V_{iso}$	Isolation voltage (Input to Output)			2250	Vdc
$V_{iso}$	Isolation voltage (Input to Baseplate)			1500	Vdc
$V_{iso}$	Isolation voltage (Baseplate to Output)			1000	Vdc
$V_{tr}$	Input voltage transient (tp 1s)			80	V
$V_{RC}$	Remote Control pin voltage (see Operating Information section)	Positive logic option		5	V
		Negative logic option	0	5	V

Stresses above those listed under Absolute Maximum Ratings may cause permanent damage to the device. This is a stress rating only; functional operation of the device at these or any other conditions above those indicated in the Electrical Specification section of this specification is not implied. Exposure to absolute maximum rating conditions for extended periods may affect device reliability.

Fundamental Circuit Diagram For PKJ8213PI (P)

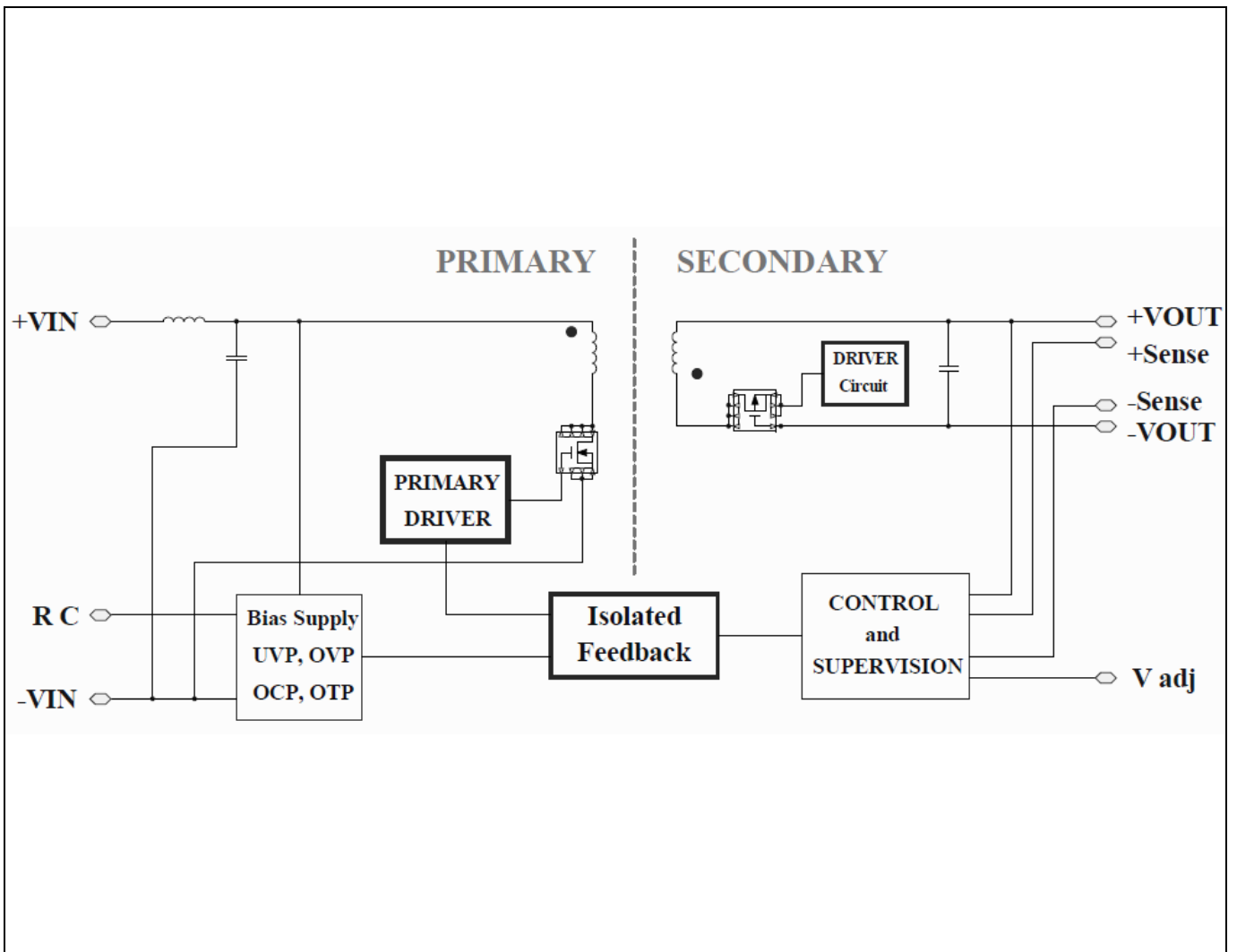

**PKJ8200 series DC-DC Converters**  
 Input 9-75 V, Output up to 16.7 A / 200 W

28701-BMR7148200 Rev B      October 2023  
 © Flex

**Fundamental Circuit Diagram For PKJ8216ZPI (P), PKJ8216JPI (P), PKJ8216HPI(P)**

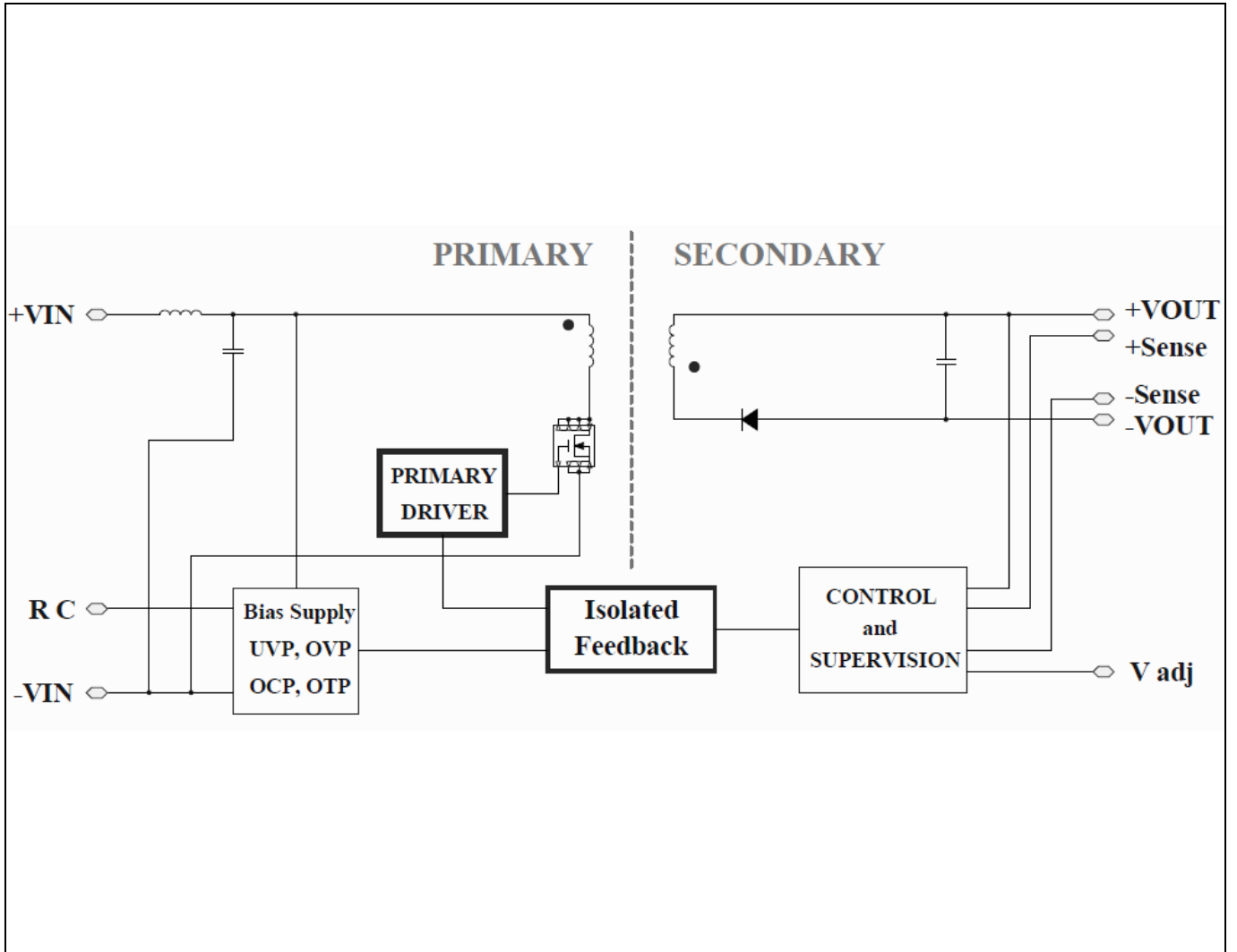

## Technical Specification

**PKJ8200 series DC-DC Converters**  
Input 9-75 V, Output up to 16.7 A / 200 W

28701-BMR7148200 Rev B      October 2023  
© Flex

**Electrical Specification**  
**12 V, 16.7 A / 200 W**

**PKJ8213PI(P)**

$T_{P1} = -40$  to  $+110^{\circ}\text{C}$ ,  $V_I = 9$  to  $75$  V, sense pins connected to output pins unless otherwise specified under Conditions.

Typical values given at:  $T_{P1} = +25^{\circ}\text{C}$ ,  $V_I = 36$  V, max  $I_O$ , unless otherwise specified under Conditions.

At least 330  $\mu\text{F}$  E-Cap is to be added in the input terminal for stabilizing input voltage source.  $C_O = 100$   $\mu\text{F}$

Characteristics		Conditions	min	typ	max	Unit
$V_I$	Input voltage range		9		75	V
$V_{\text{loff}}$	Turn-off input voltage	Decreasing input voltage	7.5	8	8.5	V
$V_{\text{lon}}$	Turn-on input voltage	Increasing input voltage	8	8.5	9	V
$C_i$	Internal input capacitance			44		$\mu\text{F}$
$P_O$	Output power		0		200	W
$\eta$	Efficiency	50% of max $I_O$ , $V_I = 36$ V		92		
		max $I_O$ , $V_I = 36$ V		91.5		
$P_d$	Power Dissipation	max $I_O$		18.7		W
$P_{\text{li}}$	Input idling power	$I_O = 0$ A, $V_I = 36$ V		1.5		W
$P_{\text{RC}}$	Input standby power	$V_I = 36$ V (turned off with RC)		0.3		W
$f_s$	Switching frequency	0-100 % of max $I_O$		200		kHz

$V_{O_i}$	Output voltage initial setting and accuracy	$T_{P1} = +25^{\circ}\text{C}$ , $V_I = 36$ V, $I_O = 16.7$ A	11.88	12	12.12	V
$V_O$	Output adjust range	0-100% of max $I_O$ at 10-75Vin range , $P_{\text{out}} \leq$ max rated power	6		13.2	V
	Output voltage tolerance band	0-100% of max $I_O$	11.88	12	12.12	V
	Idling voltage	$I_O = 0$ A	11.88	12	12.12	V
	Line regulation	max $I_O$			$\pm 120$	mV
	Load regulation	$V_I = 36$ V, 25-100% of max $I_O$			$\pm 120$	mV
$V_{\text{tr}}$	Load transient voltage deviation	$V_I = 36$ V, Load step 50-75-50% of max $I_O$ , $di/dt = 100\text{mA}/\mu\text{s}$ , $\pm 1\%$ error band		$\pm 120$		mV
$t_{\text{tr}}$	Load transient recovery time				500	$\mu\text{s}$
$t_r$	Ramp-up time (from 10-90% of $V_{O_i}$ )	10-100% of max $I_O$ , $T_{P1} = 25^{\circ}\text{C}$ , $V_I = 36$ V		11		ms
$t_s$	Start-up time (from $V_I$ connection to 90% of $V_{O_i}$ )			60		ms
$t_{\text{RC}}$	RC start-up time (from $V_{\text{RC}}$ connection to 90% of $V_{O_i}$ )	max $I_O$		12		ms
RC	Sink current	See operating information	0.5			mA
	Trigger level	Decreasing / Increasing RC-voltage		0.8/2.5		V
$t_f$	$V_I$ shut-down fall time (from $V_I$ off to 10% of $V_O$ )	max $I_O$		1.8		ms
$I_O$	Output current		0		16.7	A
$I_{\text{lim}}$	Current limit threshold	$T_{P1} < \text{max } T_{P1}$	20		35	A
$I_{\text{sc}}$	Short circuit current	$T_{P1} = 25^{\circ}\text{C}$ , see Note 1		1.35		A
$C_{\text{out}}$	Recommended Capacitive Load	$T_{P1} = 25^{\circ}\text{C}$	100		10000	$\mu\text{F}$
$V_{\text{Oac}}$	Output ripple & noise	See ripple & noise section, $V_{O_i}$ , max $I_O$ , see Note 2		30	150	mVp-p
OVP	Over voltage protection	$T_{P1} = +25^{\circ}\text{C}$ , $V_I = 36$ V, 0-100% of max $I_O$	15		18	V

Note 1: RMS current at OCP in hiccup mode.

Note 2: Measured by 20 MHz bandwidth with 47  $\mu\text{F}/25$  V POS-CAP and a 1  $\mu\text{F}$  ceramic

**PKJ8200 series DC-DC Converters**  
 Input 9-75 V, Output up to 16.7 A / 200 W

28701-BMR7148200 Rev B      October 2023  
 © Flex

**Typical Characteristics**  
**12 V, 16.7 A / 200 W**

**PKJ8213PI(P)**

**Efficiency**

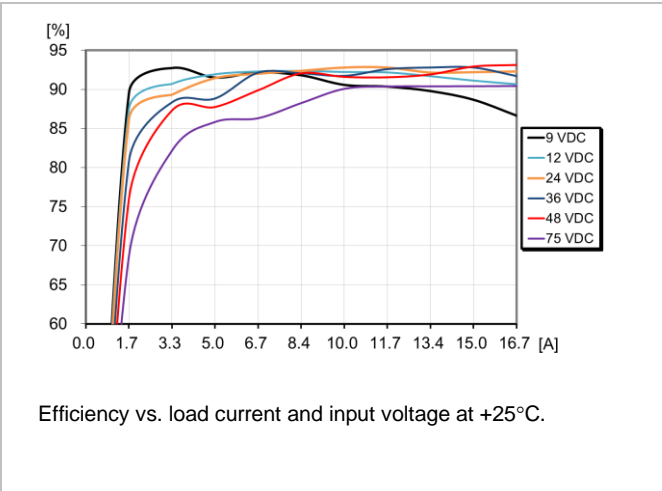

**Power Dissipation**

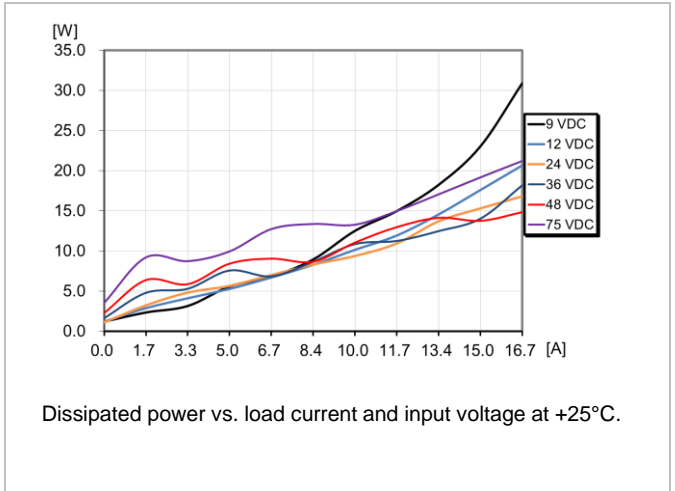

**Output Current Derating**

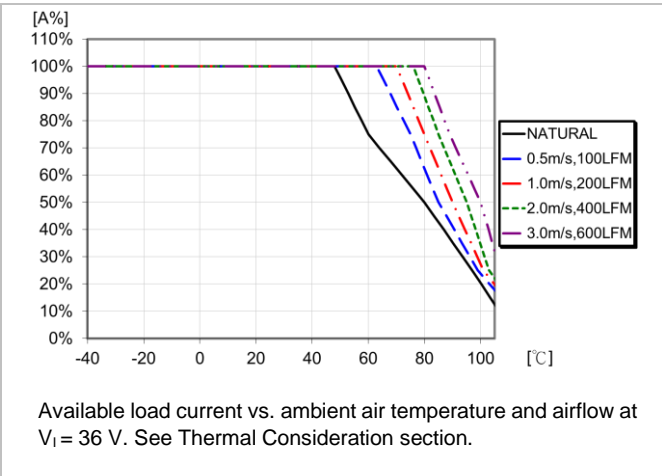

**Current Limit Characteristics**

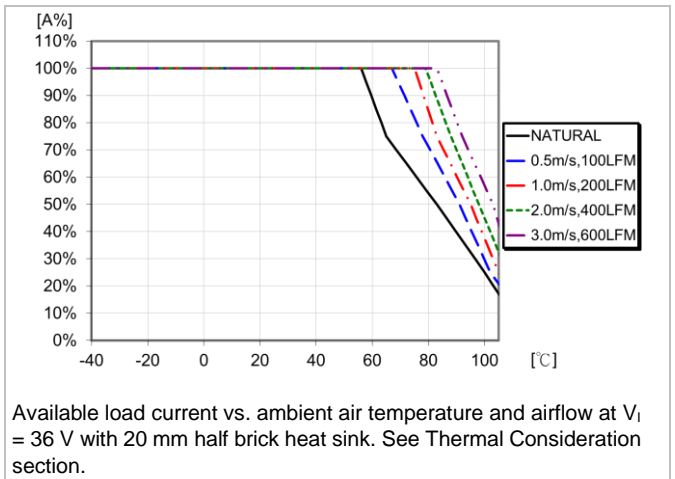
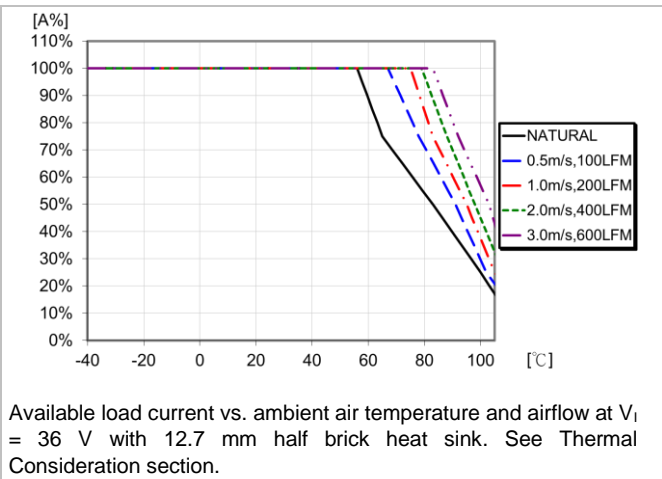
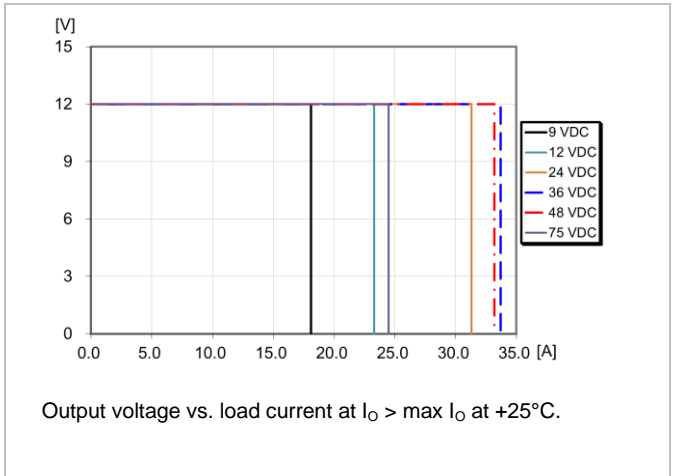

Technical Specification

**PKJ8200 series DC-DC Converters**  
 Input 9-75 V, Output up to 16.7 A / 200 W

28701-BMR7148200 Rev B      October 2023  
 © Flex

**Typical Characteristics**  
**12 V, 16.7 A / 200 W**

**PKJ8213PI(P)**

**Output Current Derating – Cold wall sealed box**

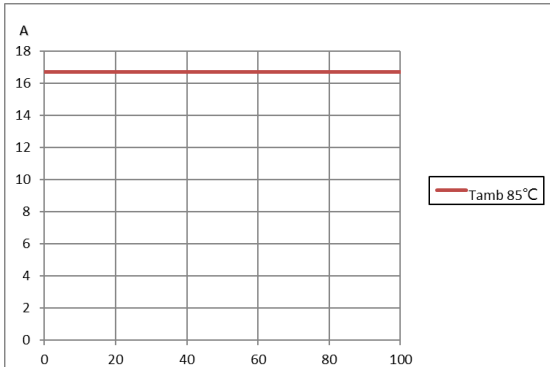

Available load current vs. cold wall temperature.  $V_1 = 36\text{ V}$ . See Thermal Consideration section.

**Max adjustable output voltage**

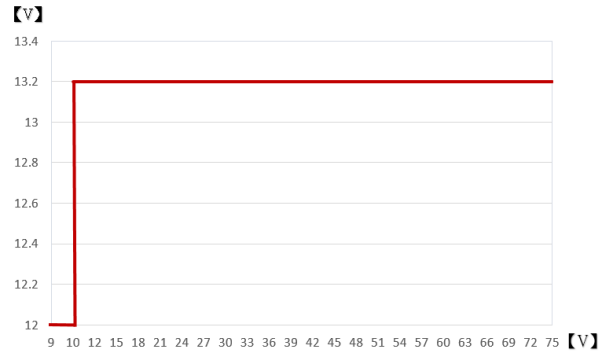

Max adjustable output voltage vs. input voltage at  $TP_1 = +25\text{ °C}$ .  
 Max adjustable output voltage  $\geq 12\text{ V}$  at  $V_1 = 9\text{ V}$ ,  $P_o = 200\text{ W}$



**PKJ8200 series DC-DC Converters**  
 Input 9-75 V, Output up to 16.7 A / 200 W

28701-BMR7148200 Rev B      October 2023  
 © Flex

**Typical Characteristics**  
**12 V, 16.7 A / 200 W**

**PKJ8213PI(P)**

**Start-up**

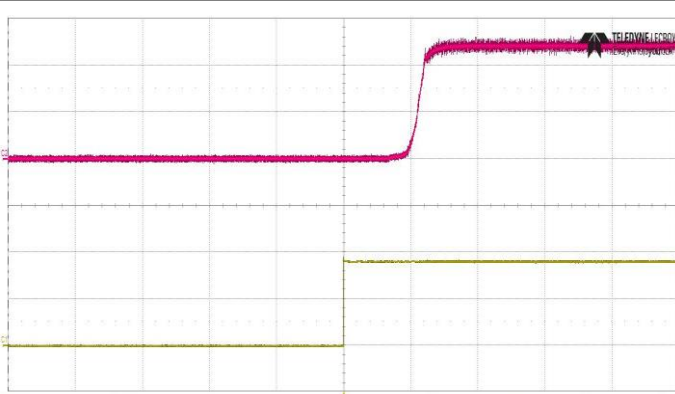

Start-up enabled by connecting  $V_i$  at:  
 $T_{P1} = +25^{\circ}\text{C}$ ,  $V_i = 36\text{ V}$ ,  
 $I_o = 16.7\text{ A}$  resistive load.  
 Top trace: output voltage (20 V/div.).  
 Bottom trace: input voltage (5 V/div.).  
 Time scale: (50 ms/div.).

**Shut-down**



Shut-down enabled by disconnecting  $V_i$  at:  
 $T_{P1} = +25^{\circ}\text{C}$ ,  $V_i = 36\text{ V}$ ,  
 $I_o = 16.7\text{ A}$  resistive load.  
 Top trace: output voltage (20 V/div.).  
 Bottom trace: input voltage (5 V/div.).  
 Time scale: (1 ms/div.).

**Output Ripple & Noise**

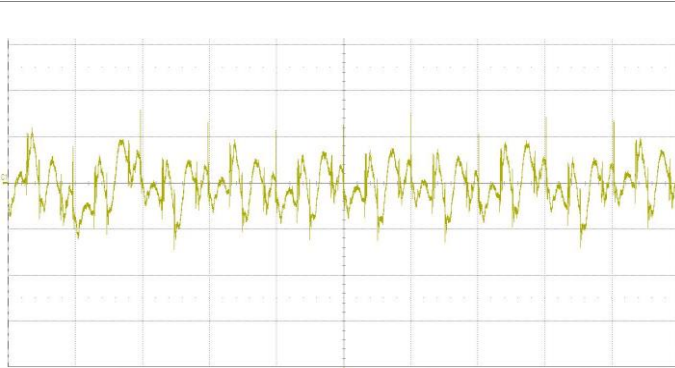

Output voltage ripple at:  
 $T_{P1} = +25^{\circ}\text{C}$ ,  $V_i = 36\text{ V}$ ,  
 $I_o = 16.7\text{ A}$  resistive load.  
 Trace: output voltage (10 mV/div.).  
 Time scale: (5 μs/div.).  
 20 MHz bandwidth.

**Output Load Transient Response**



Output voltage response to load current step-change (8.4-12.5-8.4 A) at:  
 $T_{P1} = +25^{\circ}\text{C}$ ,  $V_i = 36\text{ V}$ .  
 Top trace: output voltage (500 mV/div.).  
 Bottom trace: load current (5 A/div.).  
 Time scale: (500 μs/div.).

**Output Voltage Adjust (TRIM UP/TRIM DOWN)**

**Output Voltage = 12 V**

The resistor value for an adjusted output voltage is calculated by using the following equations:

Output Voltage Adjust, Increase:

$$R_{ADJ\_UP} = \left( \frac{5.11 \times V_{o,set} \times (100 + \Delta\%)}{1.225 \times \Delta\%} - \frac{511}{\Delta\%} - 10.22 \right) k\Omega$$

Output Voltage Adjust, Decrease:

$$R_{ADJ\_DOWN} = \left( \frac{511}{\Delta\%} - 10.22 \right) k\Omega$$

$$\Delta\% = \frac{V_{desird} - V_{o,set}}{V_{o,set}} \times 100$$

Example:

To trim up the 12 V model by 8% to 12.96 V the required external resistor is:

$$R_{ADJ\_UP} = \left( \frac{5.11 \times 12 \times (100 + 8)}{1.225 \times 8} - \frac{511}{8} - 10.22 \right) = 601.6 k\Omega$$

Example:

To trim down the 12 V model by 7% to 11.16 V the required external resistor is:

$$R_{ADJ\_DOWN} = \left( \frac{511}{7} - 10.22 \right) = 62.78 k\Omega$$

## Technical Specification

**PKJ8200 series DC-DC Converters**  
Input 9-75 V, Output up to 16.7 A / 200 W

28701-BMR7148200 Rev B      October 2023  
© Flex

**Electrical Specification**  
**24 V, 8.4 A / 200 W**

**PKJ8216ZPI(P)**

$T_{P1} = -40$  to  $+110^{\circ}\text{C}$ ,  $V_I = 9$  to  $75$  V, sense pins connected to output pins unless otherwise specified under Conditions.

Typical values given at:  $T_{P1} = +25^{\circ}\text{C}$ ,  $V_I = 36$  V, max  $I_O$ , unless otherwise specified under Conditions.

At least 330  $\mu\text{F}$  E-Cap is to be added in the input terminal for stabilizing input voltage source.  $C_O = 100$   $\mu\text{F}$

Characteristics		Conditions	min	typ	max	Unit
$V_I$	Input voltage range		9		75	V
$V_{\text{loff}}$	Turn-off input voltage	Decreasing input voltage	7.5	8	8.5	V
$V_{\text{lon}}$	Turn-on input voltage	Increasing input voltage	8	8.5	9	V
$C_i$	Internal input capacitance			44		$\mu\text{F}$
$P_O$	Output power		0		200	W
$\eta$	Efficiency	50% of max $I_O$ , $V_I = 36$ V		90.5		
		max $I_O$ , $V_I = 36$ V		91.5		
$P_d$	Power Dissipation	max $I_O$		18.7		W
$P_{\text{li}}$	Input idling power	$I_O = 0$ A, $V_I = 36$ V		1.5		W
$P_{\text{RC}}$	Input standby power	$V_I = 36$ V (turned off with RC)		0.3		W
$f_s$	Switching frequency	0-100 % of max $I_O$		200		kHz

$V_{O_i}$	Output voltage initial setting and accuracy	$T_{P1} = +25^{\circ}\text{C}$ , $V_I = 36$ V, $I_O = 8.4$ A	23.76	24	24.24	V
$V_O$	Output adjust range	See operating information	12		26.4	V
	Output voltage tolerance band	0-100% of max $I_O$	23.76	24	24.24	V
	Idling voltage	$I_O = 0$ A	23.76	24	24.24	V
	Line regulation	max $I_O$			$\pm 240$	mV
	Load regulation	$V_I = 36$ V, 25-100% of max $I_O$			$\pm 240$	mV
$V_{\text{tr}}$	Load transient voltage deviation	$V_I = 36$ V, Load step 50-75-50% of max $I_O$ , $di/dt = 100\text{mA}/\mu\text{s}$ , $\pm 1\%$ error band		$\pm 240$		mV
$t_{\text{tr}}$	Load transient recovery time			500		$\mu\text{s}$
$t_r$	Ramp-up time (from 10-90% of $V_{O_i}$ )	10-100% of max $I_O$ , $T_{P1} = 25^{\circ}\text{C}$ , $V_I = 36$ V		11		ms
$t_s$	Start-up time (from $V_I$ connection to 90% of $V_{O_i}$ )			60		ms
$t_{\text{RC}}$	RC start-up time (from $V_{\text{RC}}$ connection to 90% of $V_{O_i}$ )		max $I_O$		12	
RC	Sink current	See operating information	0.5			mA
	Trigger level	Decreasing / Increasing RC-voltage		0.8/2.5		V
$t_f$	$V_I$ shut-down fall time (from $V_I$ off to 10% of $V_O$ )	max $I_O$		1.8		ms
$I_O$	Output current		0		8.4	A
$I_{\text{lim}}$	Current limit threshold	$T_{P1} < \text{max } T_{P1}$	10		16	A
$I_{\text{sc}}$	Short circuit current	$T_{P1} = 25^{\circ}\text{C}$ , see Note 1		1.35		A
$C_{\text{out}}$	Recommended Capacitive Load	$T_{P1} = 25^{\circ}\text{C}$	100		3000	$\mu\text{F}$
$V_{\text{Oac}}$	Output ripple & noise	See ripple & noise section, $V_{O_i}$ , max $I_O$ , see Note 2		40	100	mVp-p
OVP	Over voltage protection	$T_{P1} = +25^{\circ}\text{C}$ , $V_I = 36$ V, 0-100% of max $I_O$	28		38	V

Note 1: RMS current at OCP in hiccup mode.

Note 2: Measured by 20 MHz bandwidth with 47  $\mu\text{F}/25$  V POS-CAP and a 1  $\mu\text{F}$  ceramic

**PKJ8200 series DC-DC Converters**  
 Input 9-75 V, Output up to 16.7 A / 200 W

28701-BMR7148200 Rev B      October 2023  
 © Flex

**Typical Characteristics**  
**24 V, 8.4 A / 200 W**

**PKJ8216ZPI(P)**

**Efficiency**

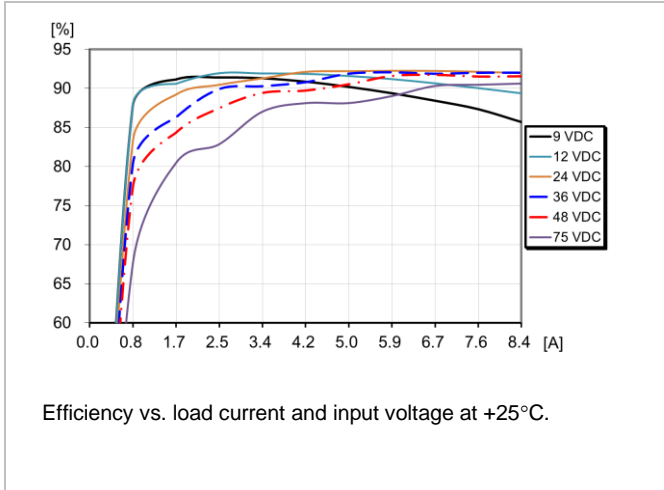

**Power Dissipation**

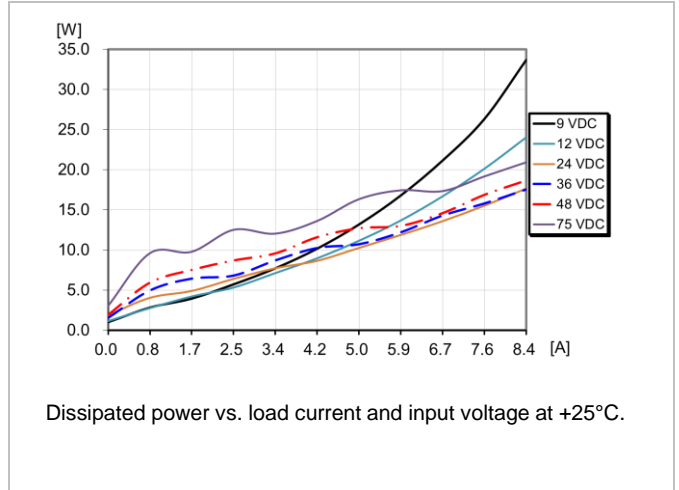

**Output Current Derating**

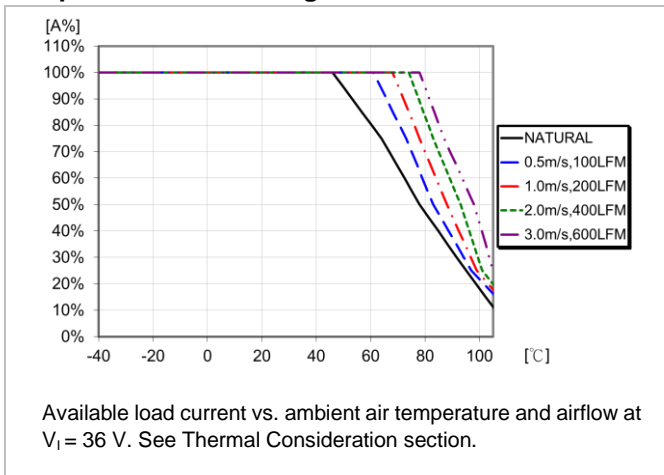

**Current Limit Characteristics**

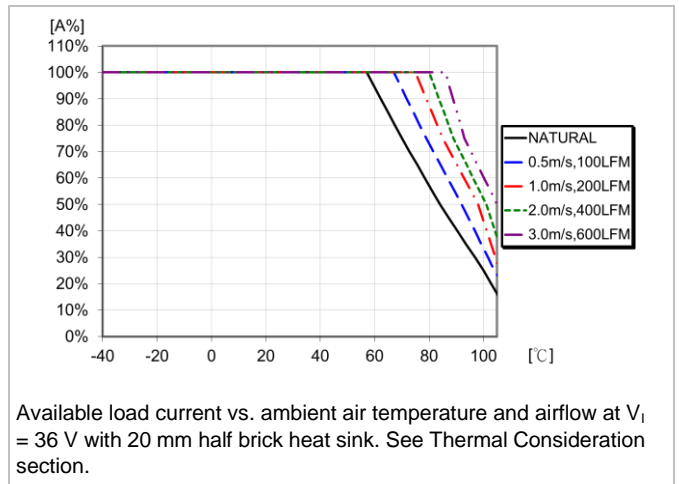
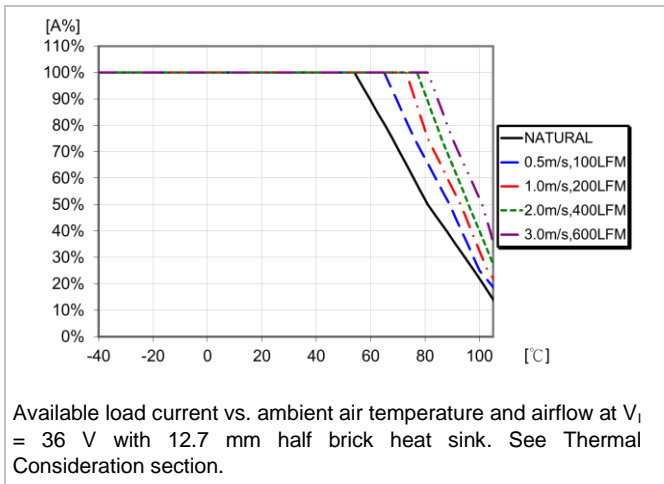
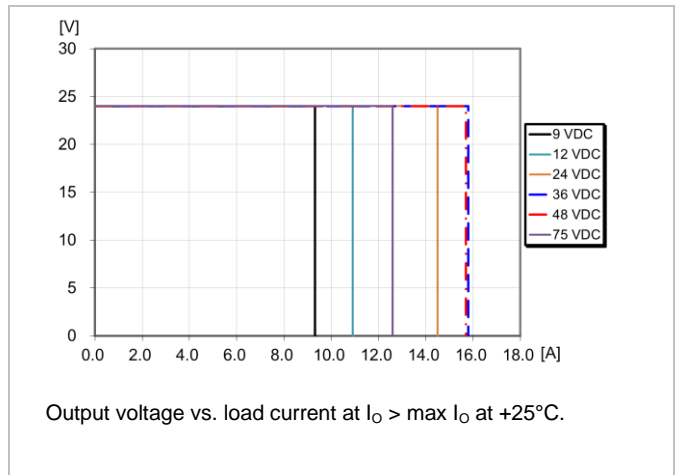

Technical Specification

**PKJ8200 series DC-DC Converters**  
 Input 9-75 V, Output up to 16.7 A / 200 W

28701-BMR7148200 Rev B      October 2023  
 © Flex

**Typical Characteristics**  
**24 V, 8.4 A / 200 W**

**PKJ8216ZPI(P)**

**Output Current Derating – Cold wall sealed box**

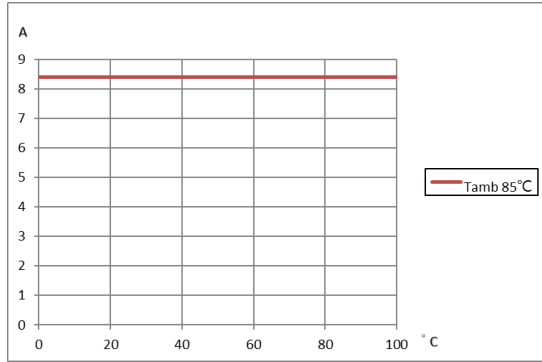

Available load current vs. cold wall temperature.  $V_i = 36$  V. See Thermal Consideration section.

**Max adjustable output voltage**

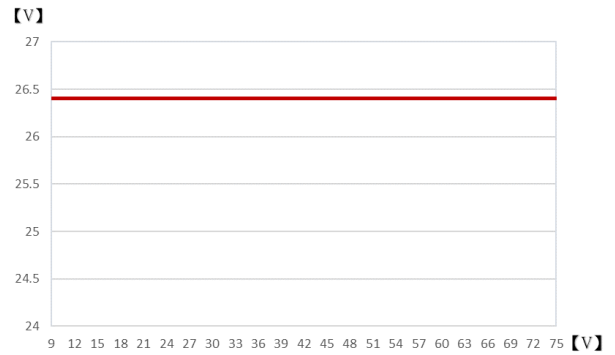

Max adjustable output voltage vs. input voltage at  $TP_1 = +25$  °C.  
 Max adjustable output voltage  $\geq 26.4$  V,  $P_o = 200$  W

**PKJ8200 series DC-DC Converters**  
 Input 9-75 V, Output up to 16.7 A / 200 W

28701-BMR7148200 Rev B      October 2023  
 © Flex

**Typical Characteristics**  
**24 V, 8.4 A / 200 W**

**PKJ8216ZPI(P)**

**Start-up**

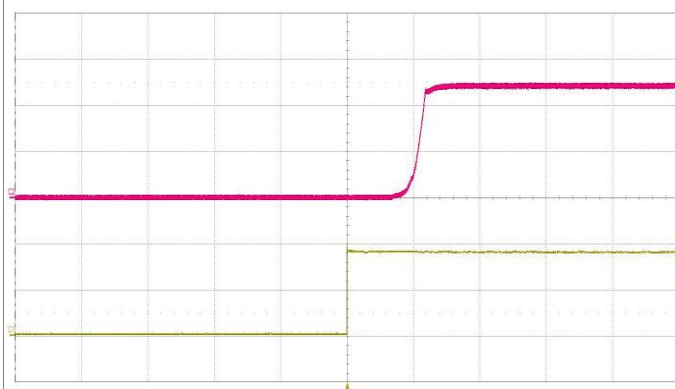

Start-up enabled by connecting  $V_i$  at:  
 $T_{P1} = +25^\circ\text{C}$ ,  $V_i = 36\text{ V}$ ,  
 $I_o = 8.4\text{ A}$  resistive load.  
 Top trace: output voltage (10 V/div.).  
 Bottom trace: input voltage (20 V/div.).  
 Time scale: (50 ms/div.).

**Shut-down**

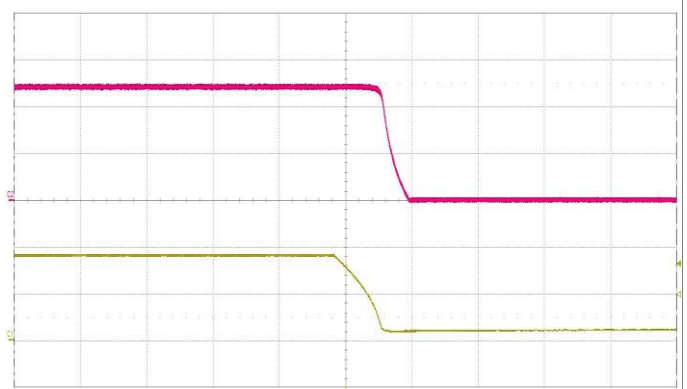

Shut-down enabled by disconnecting  $V_i$  at:  
 $T_{P1} = +25^\circ\text{C}$ ,  $V_i = 36\text{ V}$ ,  
 $I_o = 8.4\text{ A}$  resistive load.  
 Top trace: output voltage (10 V/div.).  
 Bottom trace: input voltage (20 V/div.).  
 Time scale: (1 ms/div.).

**Output Ripple & Noise**

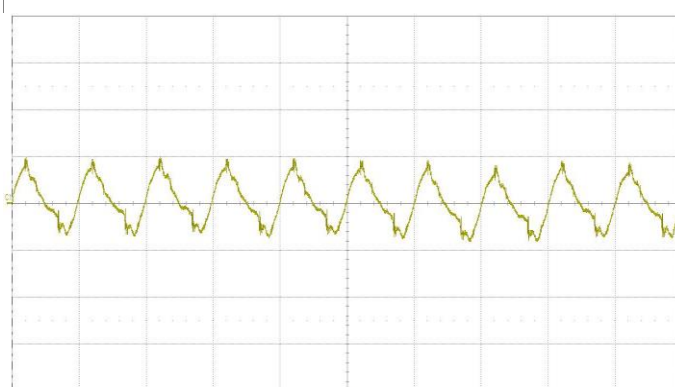

Output voltage ripple at:  
 $T_{P1} = +25^\circ\text{C}$ ,  $V_i = 36\text{ V}$ ,  
 $I_o = 8.4\text{ A}$  resistive load.  
 Trace: output voltage (20 mV/div.).  
 Time scale: (5 μs/div.).  
 20 MHz bandwidth.

**Output Load Transient Response**

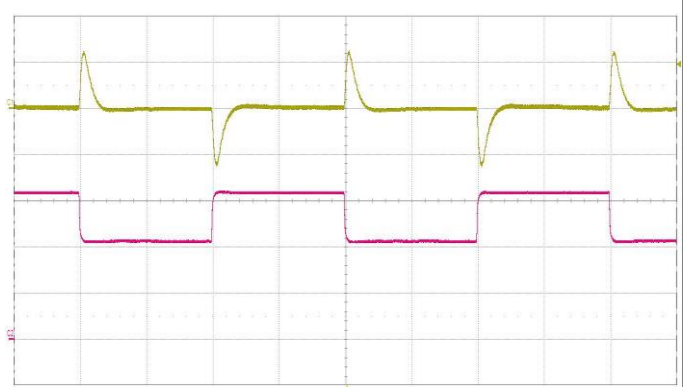

Output voltage response to load current step-change (4.2-6.3-4.2 A) at:  
 $T_{P1} = +25^\circ\text{C}$ ,  $V_i = 36\text{ V}$ .  
 Top trace: output voltage (500 mV/div.).  
 Bottom trace: load current (2 A/div.).  
 Time scale: (500 μs/div.).

**Output Voltage Adjust (TRIM UP/TRIM DOWN)**

**Output Voltage = 24 V**

The resistor value for an adjusted output voltage is calculated by using the following equations:

Output Voltage Adjust, Increase:

$$R_{ADJ\_UP} = \left( \frac{5.11 \times V_{o,set} \times (100 + \Delta\%)}{1.225 \times \Delta\%} - \frac{511}{\Delta\%} - 10.22 \right) k\Omega$$

Output Voltage Adjust, Decrease:

$$R_{ADJ\_DOWN} = \left( \frac{511}{\Delta\%} - 10.22 \right) k\Omega$$

$$\Delta\% = \frac{V_{desired} - V_{o,set}}{V_{o,set}} \times 100$$

Example:

To trim up the 24 V model by 8% to 25.92 V the required external resistor is:

$$R_{ADJ\_UP} = \left( \frac{5.11 \times 24 \times (100 + 8)}{1.225 \times 8} - \frac{511}{8} - 10.22 \right) = 1277.45 k\Omega$$

Example:

To trim down the 24 V model by 7% to 22.32 V the required external resistor is:

$$R_{ADJ\_DOWN} = \left( \frac{511}{7} - 10.22 \right) = 62.78 k\Omega$$

## Technical Specification

**PKJ8200 series DC-DC Converters**  
Input 9-75 V, Output up to 16.7 A / 200 W

28701-BMR7148200 Rev B      October 2023  
© Flex

**Electrical Specification**  
**48 V, 4.2 A / 200 W**

**PKJ8216JPI(P)**

$T_{P1} = -40$  to  $+110^{\circ}\text{C}$ ,  $V_I = 9$  to  $75$  V, sense pins connected to output pins unless otherwise specified under Conditions.

Typical values given at:  $T_{P1} = +25^{\circ}\text{C}$ ,  $V_I = 36$  V, max  $I_O$ , unless otherwise specified under Conditions.

At least  $330\ \mu\text{F}$  E-Cap is to be added in the input terminal for stabilizing input voltage source.  $C_O = 100\ \mu\text{F}$

Characteristics		Conditions	min	typ	max	Unit
$V_I$	Input voltage range		9		75	V
$V_{Ioff}$	Turn-off input voltage	Decreasing input voltage	7.5	8	8.5	V
$V_{Ion}$	Turn-on input voltage	Increasing input voltage	8	8.5	9	V
$C_I$	Internal input capacitance			44		$\mu\text{F}$
$P_O$	Output power		0		200	W
$\eta$	Efficiency	50% of max $I_O$ , $V_I = 36$ V		89		
		max $I_O$ , $V_I = 36$ V		91.5		
$P_d$	Power Dissipation	max $I_O$		18.7		W
$P_{ii}$	Input idling power	$I_O = 0$ A, $V_I = 36$ V		1.5		W
$P_{RC}$	Input standby power	$V_I = 36$ V (turned off with RC)		0.3		W
$f_s$	Switching frequency	0-100 % of max $I_O$		200		kHz

$V_{Oi}$	Output voltage initial setting and accuracy	$T_{P1} = +25^{\circ}\text{C}$ , $V_I = 36$ V, $I_O = 4.2$ A	47.52	48	48.48	V
$V_O$	Output adjust range	See operating information	24		52.8	V
	Output voltage tolerance band	0-100% of max $I_O$	47.28	48	48.72	V
	Idling voltage	$I_O = 0$ A	47.28	48	48.72	V
	Line regulation	max $I_O$			$\pm 480$	mV
	Load regulation	$V_I = 36$ V, 25-100% of max $I_O$			$\pm 480$	mV
$V_{tr}$	Load transient voltage deviation	$V_I = 36$ V, Load step 50-75-50% of max $I_O$ , $di/dt = 100\text{mA}/\mu\text{s}$ , $\pm 1\%$ error band		$\pm 480$		mV
$t_{tr}$	Load transient recovery time			500		$\mu\text{s}$
$t_r$	Ramp-up time (from 10-90% of $V_{Oi}$ )	10-100% of max $I_O$ , $T_{P1} = 25^{\circ}\text{C}$ , $V_I = 36$ V		11		ms
$t_s$	Start-up time (from $V_I$ connection to 90% of $V_{Oi}$ )			50		ms
$t_{RC}$	RC start-up time (from $V_{RC}$ connection to 90% of $V_{Oi}$ )		max $I_O$		12	
RC	Sink current	See operating information	0.5			mA
	Trigger level	Decreasing / Increasing RC-voltage		0.8/2.5		V
$t_f$	$V_I$ shut-down fall time (from $V_I$ off to 10% of $V_O$ )	max $I_O$		1.8		ms
$I_O$	Output current		0		4.2	A
$I_{lim}$	Current limit threshold	$T_{P1} < \text{max } T_{P1}$	5		10	A
$I_{sc}$	Short circuit current	$T_{P1} = 25^{\circ}\text{C}$ , see Note 1		1.35		A
$C_{out}$	Recommended Capacitive Load	$T_{P1} = 25^{\circ}\text{C}$	100		1000	$\mu\text{F}$
$V_{Oac}$	Output ripple & noise	See ripple & noise section, $V_{Oi}$ , max $I_O$ , see Note 2		200	300	mVp-p
OVP	Over voltage protection	$T_{P1} = +25^{\circ}\text{C}$ , $V_I = 36$ V, 0-100% of max $I_O$	58		72	V

Note 1: RMS current at OCP in hiccup mode.

Note 2: Measured by 20 MHz bandwidth with  $47\ \mu\text{F}/25$  V POS-CAP and a  $1\ \mu\text{F}$  ceramic

**PKJ8200 series DC-DC Converters**  
 Input 9-75 V, Output up to 16.7 A / 200 W

28701-BMR7148200 Rev B      October 2023  
 © Flex

**Typical Characteristics**  
**48 V, 4.2 A / 200 W**

**PKJ8216JPI(P)**

**Efficiency**

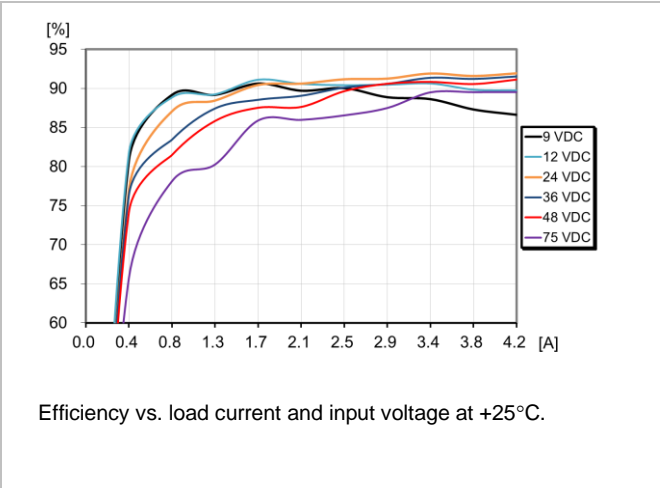

**Power Dissipation**

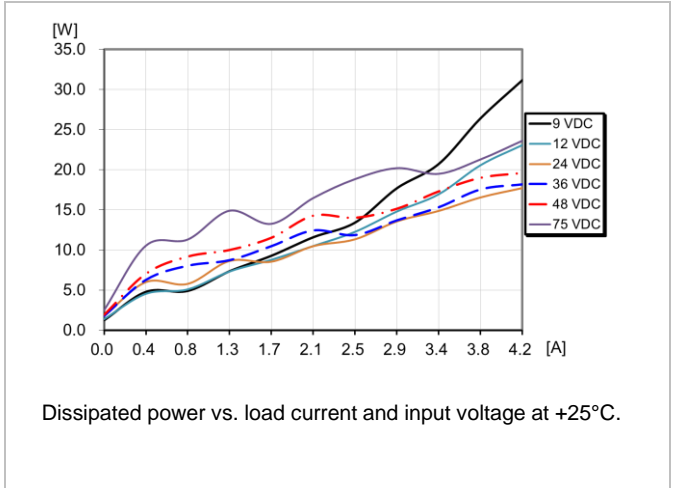

**Output Current Derating**

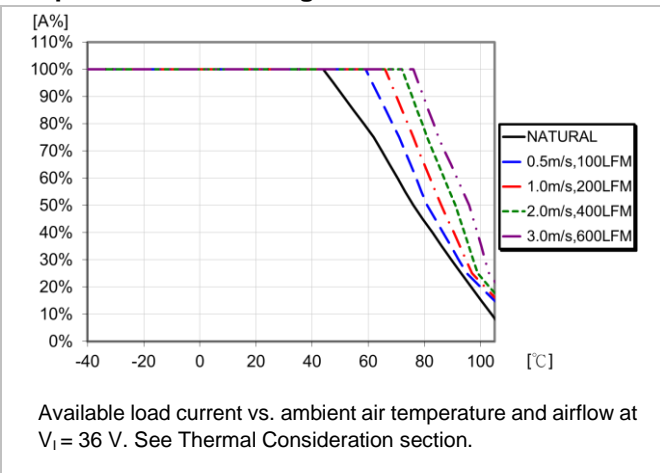

**Current Limit Characteristics**

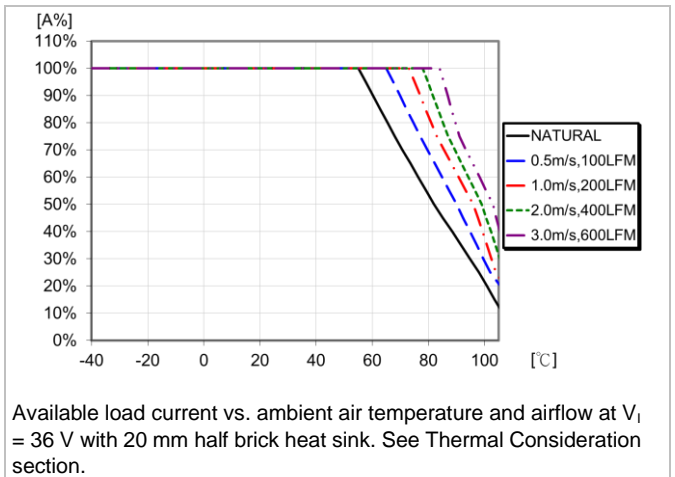
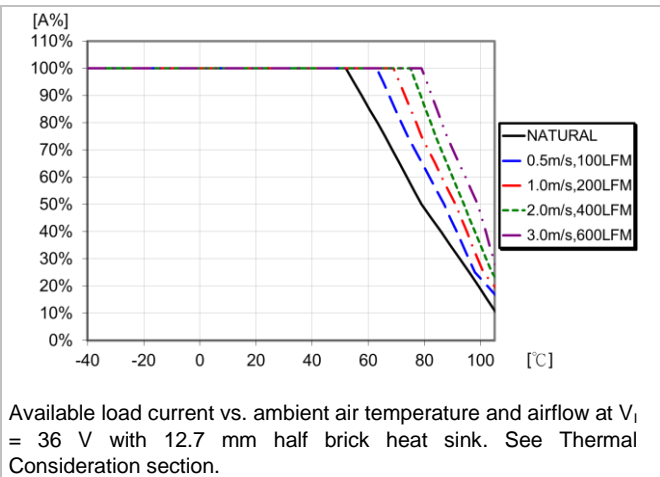
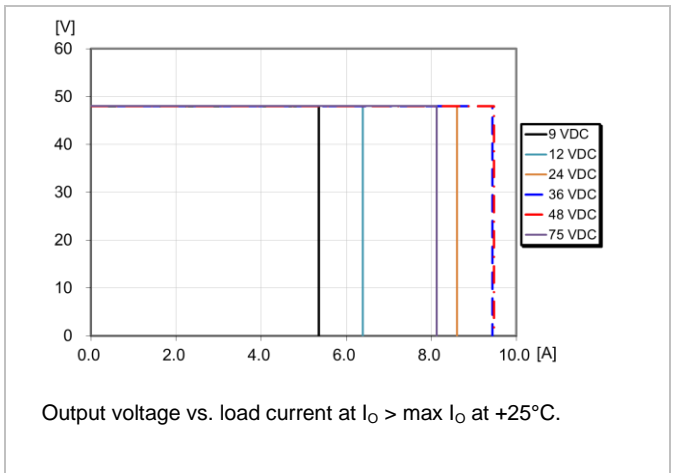

Technical Specification

**PKJ8200 series DC-DC Converters**  
 Input 9-75 V, Output up to 16.7 A / 200 W

28701-BMR7148200 Rev B      October 2023  
 © Flex

**Typical Characteristics**  
**48 V, 4.2 A / 200 W**

**PKJ8216JPI(P)**

**Output Current Derating – Cold wall sealed box**

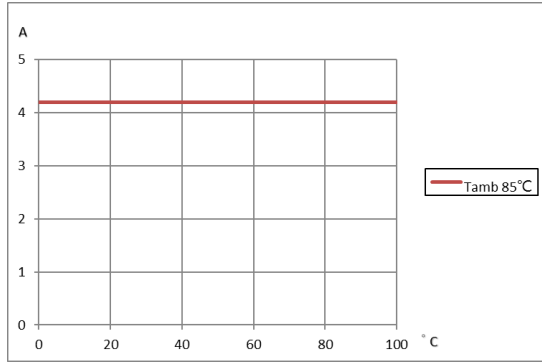

Available load current vs. cold wall temperature.  $V_i = 36$  V. See Thermal Consideration section.

**Max adjustable output voltage**

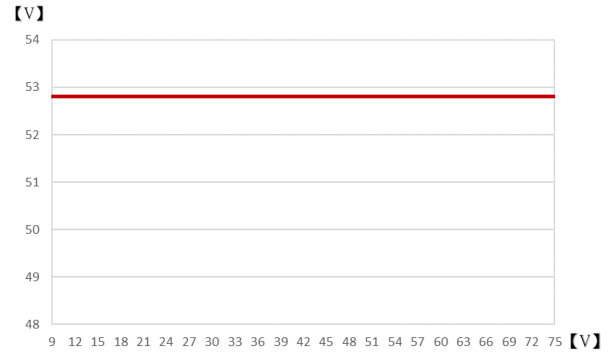

Max adjustable output voltage vs. input voltage at  $TP_1 = +25$  °C.  
 Max adjustable output voltage  $\geq 52.8$  V at  $V_i = 9$  V,  $P_o = 200$  W



**PKJ8200 series DC-DC Converters**  
 Input 9-75 V, Output up to 16.7 A / 200 W

28701-BMR7148200 Rev B      October 2023  
 © Flex

**Typical Characteristics**  
**48 V, 4.2 A / 200 W**

**PKJ8216JPI(P)**

**Start-up**

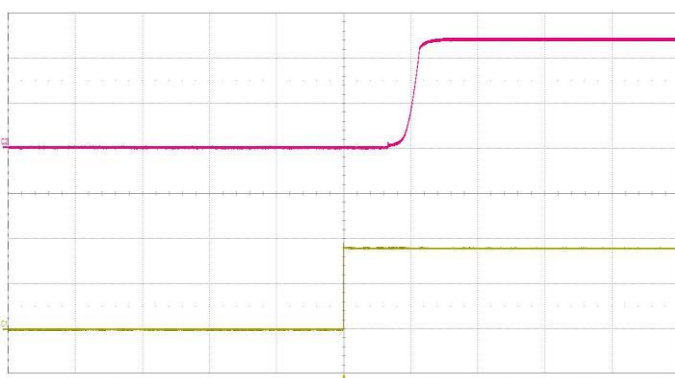

Start-up enabled by connecting  $V_i$  at:  
 $T_{P1} = +25^\circ\text{C}$ ,  $V_i = 36\text{ V}$ ,  
 $I_o = 4.2\text{ A}$  resistive load.  
 Top trace: output voltage (20 V/div.),  
 Bottom trace: input voltage (20 V/div.),  
 Time scale: (50 ms/div.).

**Shut-down**

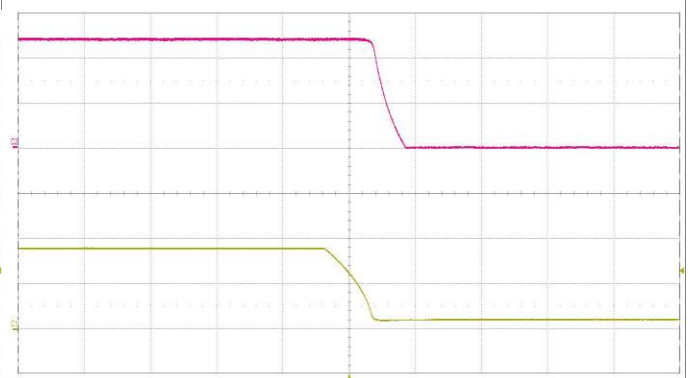

Shut-down enabled by disconnecting  $V_i$  at:  
 $T_{P1} = +25^\circ\text{C}$ ,  $V_i = 36\text{ V}$ ,  
 $I_o = 4.2\text{ A}$  resistive load.  
 Top trace: output voltage (20 V/div.),  
 Bottom trace: input voltage (20 V/div.),  
 Time scale: (1 ms/div.).

**Output Ripple & Noise**

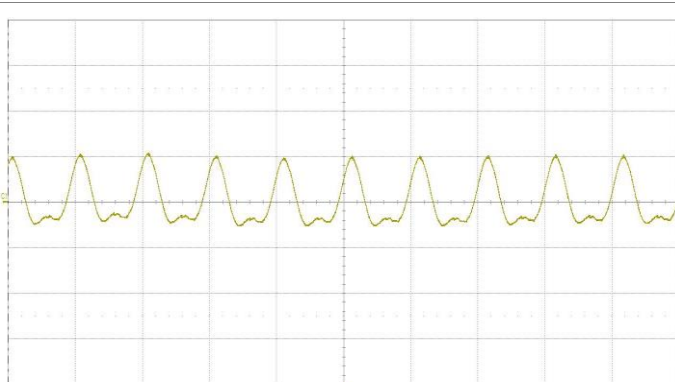

Output voltage ripple at:  
 $T_{P1} = +25^\circ\text{C}$ ,  $V_i = 36\text{ V}$ ,  
 $I_o = 4.2\text{ A}$  resistive load.  
 Trace: output voltage (100 mV/div.),  
 Time scale: (5 μs/div.),  
 20 MHz bandwidth.

**Output Load Transient Response**

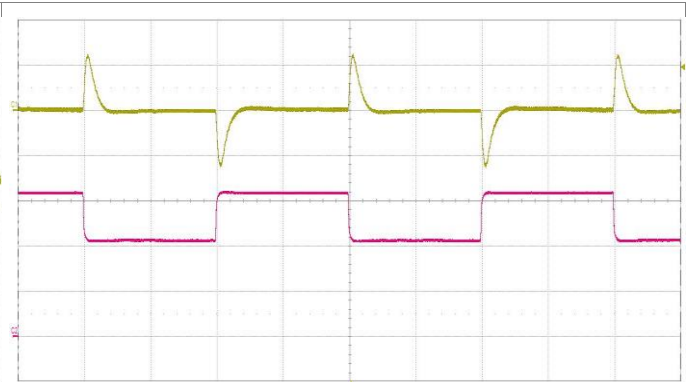

Output voltage response to load current step-change (2.1-3.15-2.1 A) at:  
 $T_{P1} = +25^\circ\text{C}$ ,  $V_i = 36\text{ V}$ .  
 Top trace: output voltage (500 mV/div.),  
 Bottom trace: load current (2 A/div.),  
 Time scale: (500 μs/div.).

**Output Voltage Adjust (TRIM UP/TRIM DOWN)**

**Output Voltage = 48 V**

The resistor value for an adjusted output voltage is calculated by using the following equations:

Output Voltage Adjust, Increase:

$$R_{ADJ\_UP} = \left( \frac{5.11 \times V_{o,set} \times (100 + \Delta\%)}{1.225 \times \Delta\%} - \frac{511}{\Delta\%} - 10.22 \right) k\Omega$$

Output Voltage Adjust, Decrease:

$$R_{ADJ\_DOWN} = \left( \frac{511}{\Delta\%} - 10.22 \right) k\Omega$$

$$\Delta\% = \frac{V_{desird} - V_{o,set}}{V_{o,set}} \times 100$$

Example:

To trim up the 48 V model by 8% to 51.84 V the required external resistor is:

$$R_{ADJ\_UP} = \left( \frac{5.11 \times 48 \times (100 + 8)}{1.225 \times 8} - \frac{511}{8} - 10.22 \right) = 2629 k\Omega$$

Example:

To trim down the 48 V model by 7% to 44.64 V the required external resistor is:

$$R_{ADJ\_DOWN} = \left( \frac{511}{7} - 10.22 \right) = 62.78 k\Omega$$

## Technical Specification

**PKJ8200 series DC-DC Converters**  
Input 9-75 V, Output up to 16.7 A / 200 W

28701-BMR7148200 Rev B October 2023  
© Flex

**Electrical Specification**  
**54 V, 3.7 A / 200 W**

**PKJ8216HPI(P)**

$T_{P1} = -40$  to  $+110^{\circ}\text{C}$ ,  $V_I = 9$  to  $75$  V, sense pins connected to output pins unless otherwise specified under Conditions.

Typical values given at:  $T_{P1} = +25^{\circ}\text{C}$ ,  $V_I = 36$  V, max  $I_O$ , unless otherwise specified under Conditions.

At least 330  $\mu\text{F}$  E-Cap is to be added in the input terminal for stabilizing input voltage source.  $C_O = 100$   $\mu\text{F}$

Characteristics		Conditions	min	typ	max	Unit
$V_I$	Input voltage range		9		75	V
$V_{\text{loff}}$	Turn-off input voltage	Decreasing input voltage	7.5	8	8.5	V
$V_{\text{lon}}$	Turn-on input voltage	Increasing input voltage	8	8.5	9	V
$C_i$	Internal input capacitance			44		$\mu\text{F}$
$P_O$	Output power		0		200	W
$\eta$	Efficiency	50% of max $I_O$ , $V_I = 36$ V		89		
		max $I_O$ , $V_I = 36$ V		91.5		
$P_d$	Power Dissipation	max $I_O$		18.7		W
$P_{\text{li}}$	Input idling power	$I_O = 0$ A, $V_I = 36$ V		1.5		W
$P_{\text{RC}}$	Input standby power	$V_I = 36$ V (turned off with RC)		0.3		W
$f_s$	Switching frequency	0-100 % of max $I_O$		200		kHz

$V_{O_i}$	Output voltage initial setting and accuracy	$T_{P1} = +25^{\circ}\text{C}$ , $V_I = 36$ V, $I_O = 8.4$ A	53.46	54	54.54	V
$V_O$	Output adjust range	0-100% of max $I_O$ at 10-75Vin range , $P_{\text{out}} \leq$ max rated power	27		59.4	V
	Output voltage tolerance band	0-100% of max $I_O$	53.19	54	54.81	V
	Idling voltage	$I_O = 0$ A	53.19	54	54.81	V
	Line regulation	max $I_O$			$\pm 540$	mV
	Load regulation	$V_I = 36$ V, 25-100% of max $I_O$			$\pm 540$	mV
$V_{\text{tr}}$	Load transient voltage deviation	$V_I = 36$ V, Load step 50-75-50% of max $I_O$ , $di/dt = 100\text{mA}/\mu\text{s}$ , $\pm 1\%$ error band		$\pm 540$		mV
$t_{\text{tr}}$	Load transient recovery time			500		$\mu\text{s}$
$t_r$	Ramp-up time (from 10–90% of $V_{O_i}$ )	10-100% of max $I_O$ , $T_{P1} = 25^{\circ}\text{C}$ , $V_I = 36$ V		11		ms
$t_s$	Start-up time (from $V_I$ connection to 90% of $V_{O_i}$ )			50		ms
$t_{\text{RC}}$	RC start-up time (from $V_{\text{RC}}$ connection to 90% of $V_{O_i}$ )	max $I_O$		12		ms
RC	Sink current	See operating information	0.5			mA
	Trigger level	Decreasing / Increasing RC-voltage		0.8/2.5		V
$t_f$	$V_I$ shut-down fall time (from $V_I$ off to 10% of $V_O$ )	max $I_O$		1.8		ms
$I_O$	Output current		0		3.7	A
$I_{\text{lim}}$	Current limit threshold	$T_{P1} < \text{max } T_{P1}$	4.5		9	A
$I_{\text{sc}}$	Short circuit current	$T_{P1} = 25^{\circ}\text{C}$ , see Note 1		1.35		A
$C_{\text{out}}$	Recommended Capacitive Load	$T_{P1} = 25^{\circ}\text{C}$	100		1000	$\mu\text{F}$
$V_{\text{Oac}}$	Output ripple & noise	See ripple & noise section, $V_{O_i}$ , max $I_O$ , see Note 2		200	300	mVp-p
OVP	Over voltage protection	$T_{P1} = +25^{\circ}\text{C}$ , $V_I = 36$ V, 0-100% of max $I_O$	64.8		81	V

Note 1: RMS current at OCP in hiccup mode.

Note 2: Measured by 20 MHz bandwidth with 47  $\mu\text{F}/25$  V POS-CAP and a 1  $\mu\text{F}$  ceramic

**PKJ8200 series DC-DC Converters**  
 Input 9-75 V, Output up to 16.7 A / 200 W

28701-BMR7148200 Rev B      October 2023  
 © Flex

**Typical Characteristics**  
**54 V, 3.7 A / 200 W**

**PKJ8216HPI(P)**

**Efficiency**

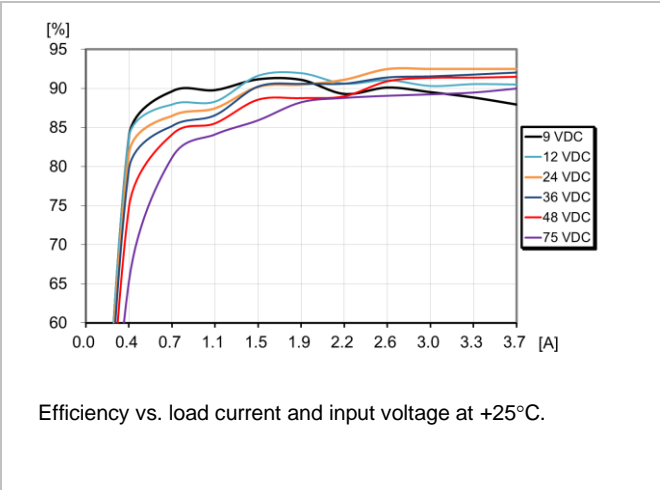

**Power Dissipation**

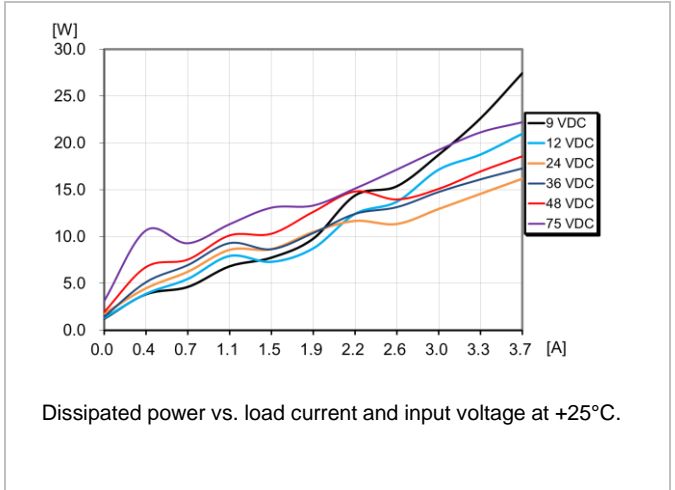

**Output Current Derating**

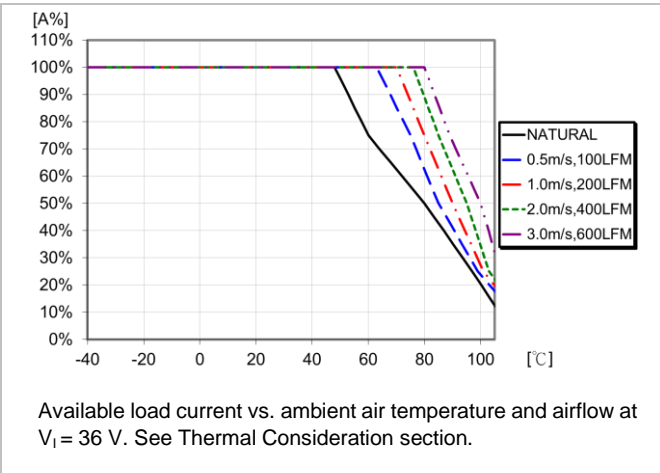

**Current Limit Characteristics**

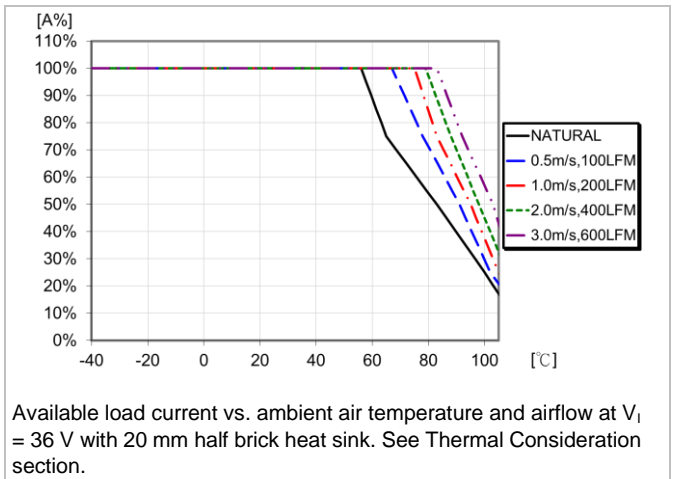
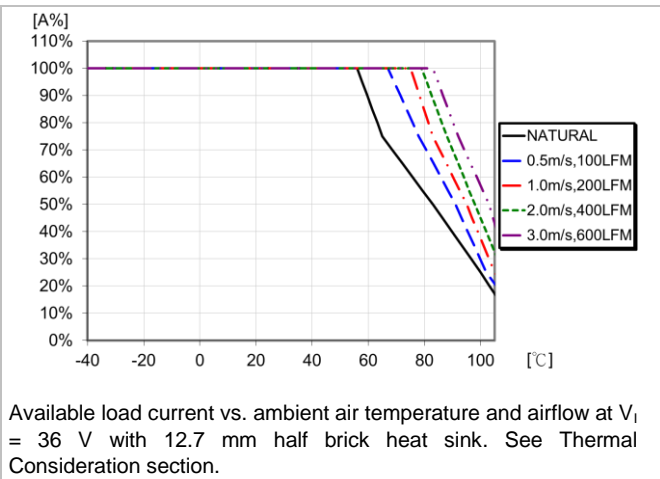
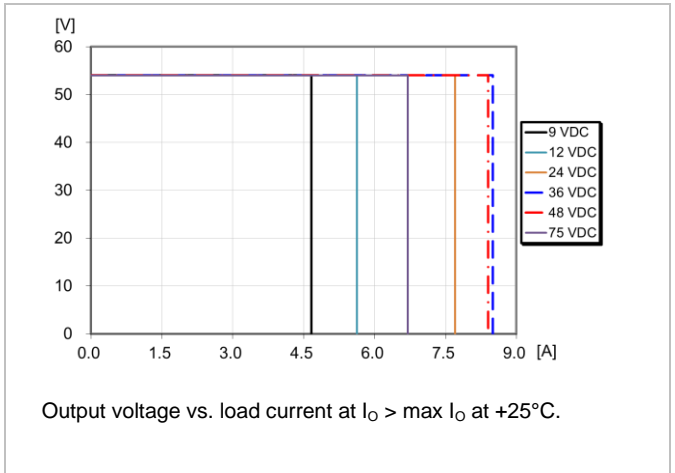

Technical Specification

**PKJ8200 series DC-DC Converters**  
 Input 9-75 V, Output up to 16.7 A / 200 W

28701-BMR7148200 Rev B      October 2023  
 © Flex

**Typical Characteristics**  
**54 V, 3.7 A / 200 W**

**PKJ8216HPI(P)**

**Output Current Derating – Cold wall sealed box**

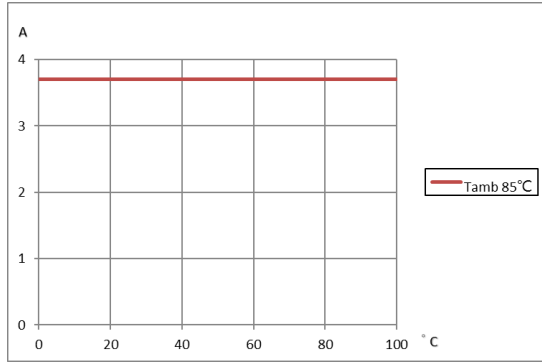

Available load current vs. cold wall temperature.  $V_i = 36$  V. See Thermal Consideration section.

**Max adjustable output voltage**

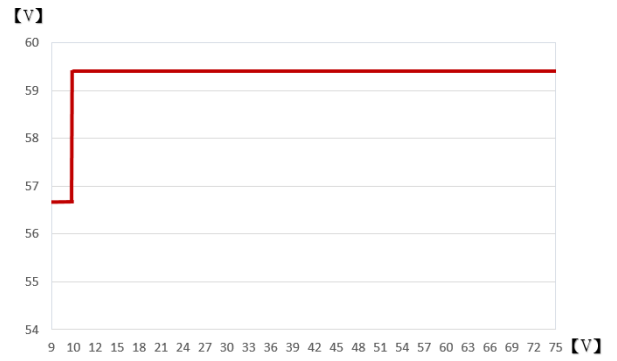

Max adjustable output voltage vs. input voltage at  $TP_1 = +25$  °C.  
 Max adjustable output voltage  $\geq 56.7$  V at  $V_i = 9$  V,  $P_o = 200$  W

Technical Specification

**PKJ8200 series DC-DC Converters**  
 Input 9-75 V, Output up to 16.7 A / 200 W

28701-BMR7148200 Rev B      October 2023  
 © Flex

**Typical Characteristics**  
**54 V, 3.7 A / 200 W**

**PKJ8216HPI(P)**

**Start-up**

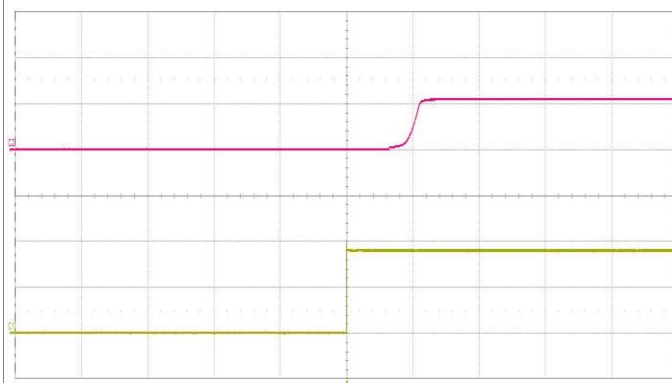

Start-up enabled by connecting  $V_I$  at:  
 $T_{P1} = +25^{\circ}\text{C}$ ,  $V_I = 36\text{ V}$ ,  
 $I_O = 3.7\text{ A}$  resistive load.  
 Top trace: output voltage (50 V/div.).  
 Bottom trace: input voltage (20 V/div.).  
 Time scale: (50 ms/div.).

**Shut-down**

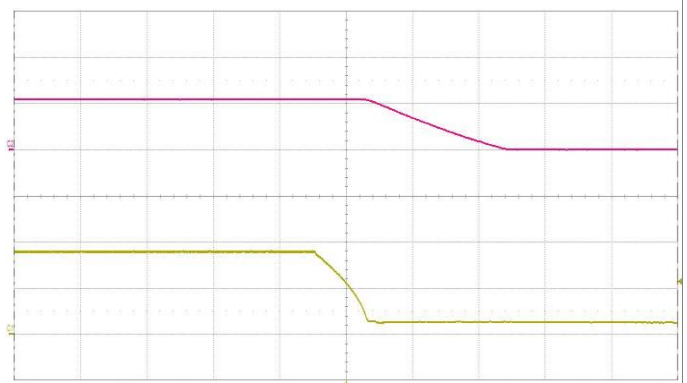

Shut-down enabled by disconnecting  $V_I$  at:  
 $T_{P1} = +25^{\circ}\text{C}$ ,  $V_I = 36\text{ V}$ ,  
 $I_O = 3.7\text{ A}$  resistive load.  
 Top trace: output voltage (50 V/div.).  
 Bottom trace: input voltage (20 V/div.).  
 Time scale: (1 ms/div.).

**Output Ripple & Noise**

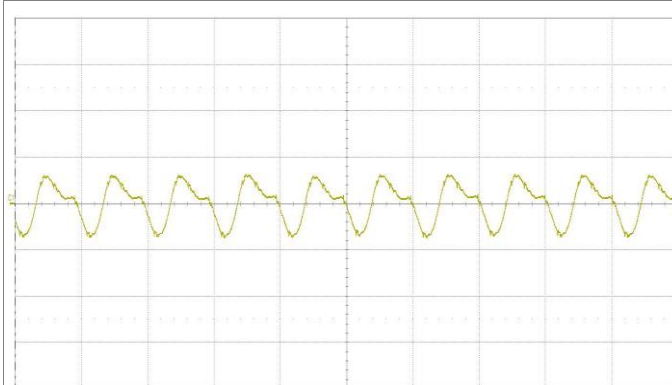

Output voltage ripple at:  
 $T_{P1} = +25^{\circ}\text{C}$ ,  $V_I = 36\text{ V}$ ,  
 $I_O = 3.7\text{ A}$  resistive load.  
 Trace: output voltage (100 mV/div.).  
 Time scale: (5 μs/div.).  
 20 MHz bandwidth.

**Output Load Transient Response**

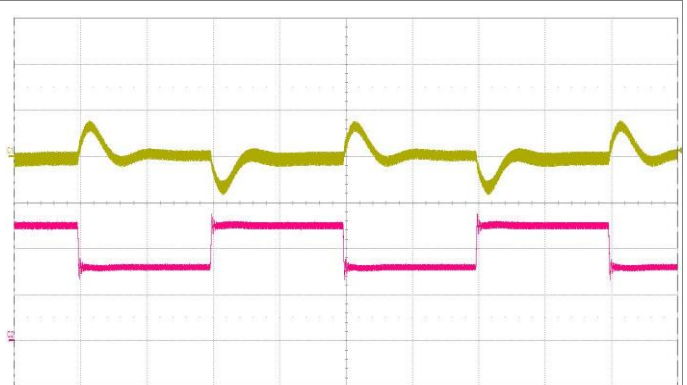

Output voltage response to load current step-change (1.85-2.775-1.85 A) at:  
 $T_{P1} = +25^{\circ}\text{C}$ ,  $V_I = 36\text{ V}$ .  
 Top trace: output voltage (500 mV/div.).  
 Bottom trace: load current (2 A/div.).  
 Time scale: (500 μs/div.).

**Output Voltage Adjust (TRIM UP/TRIM DOWN)**

**Output Voltage = 54 V**

The resistor value for an adjusted output voltage is calculated by using the following equations:

Output Voltage Adjust, Increase:

$$R_{ADJ\_UP} = \left( \frac{5.11 \times V_{O, \text{set}} \times (100 + \Delta\%)}{1.225 \times \Delta\%} - \frac{511}{\Delta\%} - 10.22 \right) k\Omega$$

Output Voltage Adjust, Decrease:

$$R_{ADJ\_DOWN} = \left( \frac{511}{\Delta\%} - 10.22 \right) k\Omega$$

$$\Delta\% = \frac{V_{\text{desired}} - V_{O, \text{set}}}{V_{O, \text{set}}} \times 100$$

Example:

To trim up the 54 V model by 8% to 58.32 V the required external resistor is:

$$R_{ADJ\_UP} = \left( \frac{5.11 \times 54 \times (100 + 8)}{1.225 \times 8} - \frac{511}{8} - 10.22 \right) = 3024 k\Omega$$

Example:

To trim down the 54 V model by 7% to 50.22 V the required external resistor is:

$$R_{ADJ\_DOWN} = \left( \frac{511}{7} - 10.22 \right) = 62.78 k\Omega$$

Technical Specification

**PKJ8200 series DC-DC Converters**  
 Input 9-75 V, Output up to 16.7 A / 200 W

28701-BMR7148200 Rev B October 2023  
 © Flex

**EMC Specification**

Conducted EMI measured according to EN55032, CISPR 32 and FCC part 15J (see test set-up). See Design Note 009 for further information. The fundamental switching frequency is 200 kHz for PKJ8200 series at  $V_i = 36\text{ V}$  and max  $I_o$ .

**Conducted EMI Input terminal value (typ)**

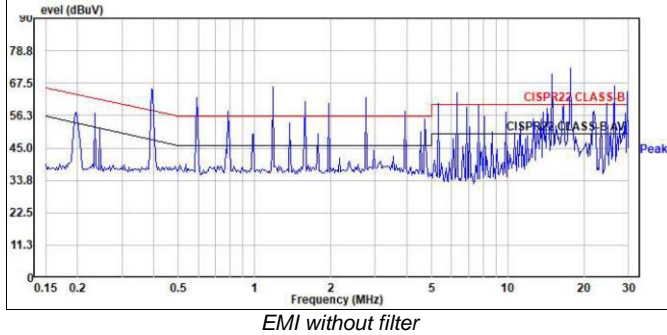

**Optional external filter for class B**

Suggested external input filter in order to meet class B in EN 55032, CISPR 32 and FCC part 15J.

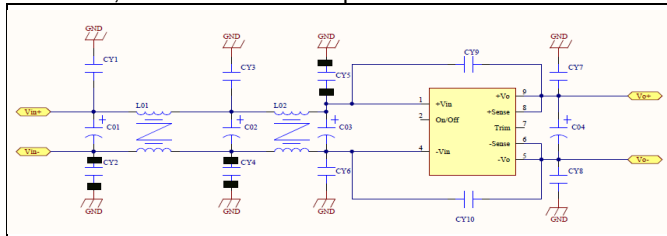

**PKJ82xx Filter components:**

- C01 = 4.5  $\mu\text{F}$ , C02 = 3  $\mu\text{F}$
- C03 = 220  $\mu\text{F}$ , C04 = 100  $\mu\text{F}$  (EE-CAP)
- CY2 = 680 pF, CY3 = 330 pF, CY4 = 330 pF, CY5 = 330 pF, CY7 = 680 pF, CY10 = 1.5 nF (Y-CAP)
- L1 = 3.25 mH, L2 = 19.5 mH (CM CHOKE)
- BEAD CORE CY2, CY4, CY5 (L43RH 3.5\*3\*1.2)
- NC: CY1, CY6, CY8, CY9

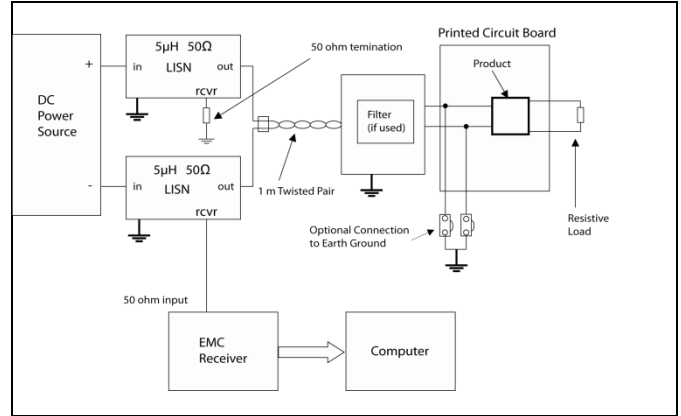
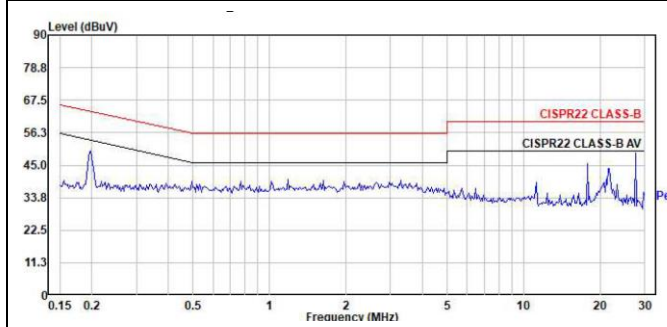

*Test set-up*

**Layout recommendations**

The radiated EMI performance of the product will depend on the PWB layout and ground layer design. It is also important to consider the stand-off of the product. If a ground layer is used, it should be connected to the output of the product and the equipment ground or chassis.

A ground layer will increase the stray capacitance in the PWB and improve the high frequency EMC performance.

**Output ripple and noise**

Output ripple and noise measured according to figure below. See Design Note 022 for detailed information.

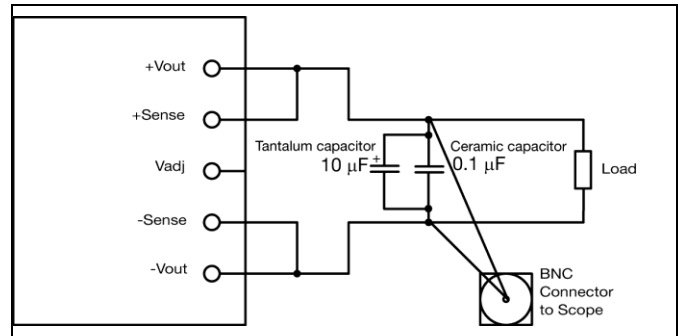

*Output ripple and noise test setup*

## Technical Specification

**PKJ8200 series DC-DC Converters**  
Input 9-75 V, Output up to 16.7 A / 200 W

28701-BMR7148200 Rev B      October 2023

© Flex

## Operating Information

### Input Voltage

The input voltage range 9 to 75 Vdc, At input voltages exceeding 75 V, the power loss will be higher than at normal input voltage and  $T_{P1}$  must be limited to absolute max +110°C. The absolute maximum continuous input voltage is 75 Vdc.

Short duration transient disturbances can occur on the DC distribution and input of the product when a short circuit fault occurs on the equipment side of a protective device (fuse or circuit breaker). The voltage level, duration and energy of the disturbance are dependant on the particular DC distribution network characteristics and can be sufficient to damage the product unless measures are taken to suppress or absorb this energy. The transient voltage can be limited by capacitors and other energy absorbing devices like zener diodes connected across the positive and negative input conductors at a number of strategic points in the distribution network. The end-user must secure that the transient voltage will not exceed the value stated in the Absolute maximum ratings. ETSI TR 100 283 examines the parameters of DC distribution networks and provides guidelines for controlling the transient and reduce its harmful effect.

### Turn-off Input Voltage

The products monitor the input voltage and will turn on and turn off at predetermined levels. The minimum hysteresis between turn on and turn off input voltage is 1.0V.

### Remote Control (RC)

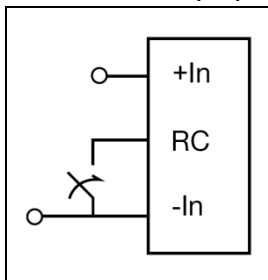

The products are fitted with a remote control function referenced to the primary negative input connection (-In), with negative and positive logic options available. The RC function allows the product to be turned on/off by an external device like a semiconductor or mechanical switch. The RC pin has an internal pull up resistor to +In.

The external device must provide a minimum required sink current to guarantee a voltage not higher than maximum voltage on the RC pin (see Electrical characteristics table). When the RC pin is left open, the voltage generated on the RC pin is 3 - 5 V.

The standard product is provided with "negative logic" RC and will be on until the RC pin is connected to the -In. To turn off the product the RC pin should be left open, or connected to a voltage higher than 2 V referenced to -In. In situations where it is desired to have the product to power up automatically without the need for control signals or a switch, the RC pin can be wired directly to -In.

The second option is "positive logic" remote control, which can be ordered by adding the suffix "P" to the end of the part number. When the RC pin is left open, the product starts up automatically when the input voltage is applied. Turn off is achieved by connecting the RC pin to the -In. The product will restart automatically when this connection is opened.

See Design Note 021 for detailed information.

### Input and Output Impedance

The impedance of both the input source and the load will interact with the impedance of the product. It is important that the input source has low characteristic impedance. The products are designed for stable operation with a minimum of 330uF external capacitor connected to the input. The electrolytic capacitors will be degraded in low temperature and the ESR value may increase. The needed input capacitance in low temperature should be equivalent to 330uF at 20°C. This means that the input capacitor value may need to be substantially larger to guarantee a stable input at low temperatures. The performance in some applications can be enhanced by addition of external capacitance as described under External Decoupling Capacitors. The minimum required capacitance value depends on the output power and the input voltage. The higher output power the higher input capacitance is needed.

### External Decoupling Capacitors

When powering loads with significant dynamic current requirements, the voltage regulation at the point of load can be improved by addition of decoupling capacitors at the load. The most effective technique is to locate low ESR ceramic and electrolytic capacitors as close to the load as possible, using several parallel capacitors to lower the effective ESR. The ceramic capacitors will handle high-frequency dynamic load changes while the electrolytic capacitors are used to handle low frequency dynamic load changes. It is equally important to use low resistance and low inductance PWB layouts and cabling.

External decoupling capacitors will become part of the product's control loop. The control loop is optimized for a wide range of external capacitance and the maximum recommended value that could be used without any additional analysis is found in the Electrical specification. The ESR of the capacitors is a very important parameter. Stable operation is guaranteed with a verified ESR value of >5 mΩ across the output connections.

For further information please contact your local Ericsson Power Modules representative.

## Technical Specification

**PKJ8200 series DC-DC Converters**  
Input 9-75 V, Output up to 16.7 A / 200 W

28701-BMR7148200 Rev B      October 2023

© Flex

### Output Voltage Adjust ( $V_{adj}$ )

The products have an Output Voltage Adjust pin ( $V_{adj}$ ). This pin can be used to adjust the output voltage above or below Output voltage initial setting.

When increasing the output voltage, the voltage at the output pins (including any remote sense compensation ) must be kept below the threshold of the over voltage protection, (OVP) to prevent the product from shutting down. At increased output voltages the maximum power rating of the product remains the same, and the max output current must be decreased correspondingly.

To increase the voltage the resistor should be connected between the  $V_{adj}$  pin and +Sense pin.. The resistor value of the Output voltage adjust function is according to information given under the Output section for the respective product.

To decrease the output voltage, the resistor should be connected between the  $V_{adj}$  pin and -Sense pin.

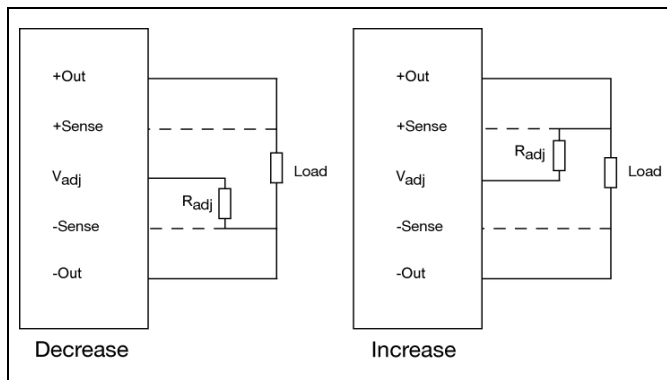

resume normal operation automatically when the temperature has dropped  $>10^{\circ}\text{C}$  below the temperature threshold.

### Over Voltage Protection (OVP)

The products have output over voltage protection that will shut down the product in over voltage conditions. The product will make continuous attempts to start up (non-latching mode) and resume normal operation automatically after removal of the over voltage condition.

### Over Current Protection (OCP)

The products include current limiting circuitry for protection at continuous overload. The output voltage will decrease towards zero for output currents in excess of max output current (max  $I_o$ ). The product will resume normal operation after removal of the overload. The load distribution should be designed for the maximum output short circuit current specified.

### Parallel Operation

Two products may be paralleled for redundancy if the total power is equal or less than  $P_o$  max. It is not recommended to parallel the products without using external current sharing circuits.

See Design Note 006 for detailed information.

### Remote Sense

The products have remote sense that can be used to compensate for voltage drops between the output and the point of load. The sense traces should be located close to the PWB ground layer to reduce noise susceptibility. The remote sense circuitry will compensate for up to 10% voltage drop between output pins and the point of load.

If the remote sense is not needed +Sense should be connected to +Out and -Sense should be connected to -Out.

### Over Temperature Protection (OTP)

The products are protected from thermal overload by an internal over temperature shutdown circuit.

When  $T_{P1}$  as defined in thermal consideration section exceeds  $120^{\circ}\text{C}$  the product will shut down. The product will make continuous attempts to start up (non-latching mode) and



Technical Specification

**PKJ8200 series DC-DC Converters**  
 Input 9-75 V, Output up to 16.7 A / 200 W

28701-BMR7148200 Rev B      October 2023  
 © Flex

**Thermal Consideration**

**General**

The products are designed to operate in different thermal environments and sufficient cooling must be provided to ensure reliable operation.

For products mounted on a PWB without a heat sink attached, cooling is achieved mainly by conduction, from the pins to the host board, and convection, which is dependant on the airflow across the product. Increased airflow enhances the cooling of the product. The Output Current Derating graph found in the Output section for each model provides the available output current vs. ambient air temperature and air velocity at  $V_i = 36V$ .

The product is tested on a 250 x 250 mm, 70  $\mu m$  (2 oz), 8-layer test board mounted vertically in a wind tunnel with a cross-section of 256 x 256 mm.

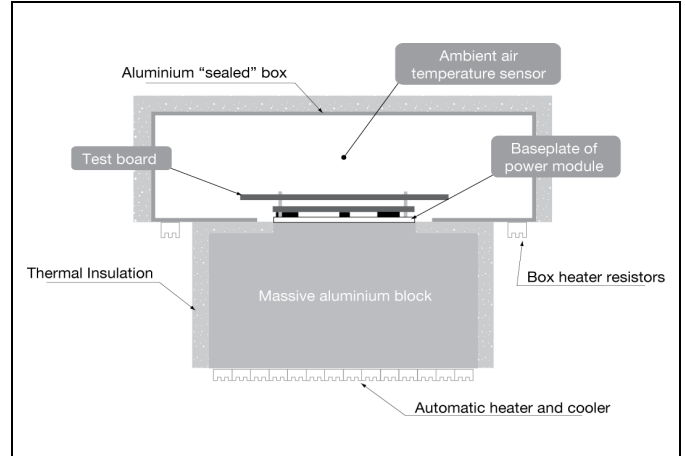

Position	Description	Max Temp.
P1	Reference point	$T_{P1} = 110^{\circ} C$

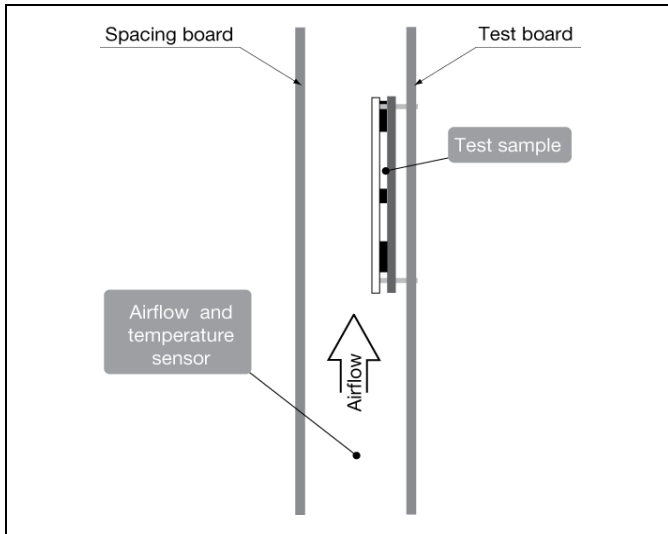

For products with base plate used in a sealed box/cold wall application, cooling is achieved mainly by conduction through the cold wall. The Output Current Derating graphs are found in the Output section for each model. The product is tested in a sealed box test set up with ambient temperatures 85, 55 and 25°C. See Design Note 028 for further details.

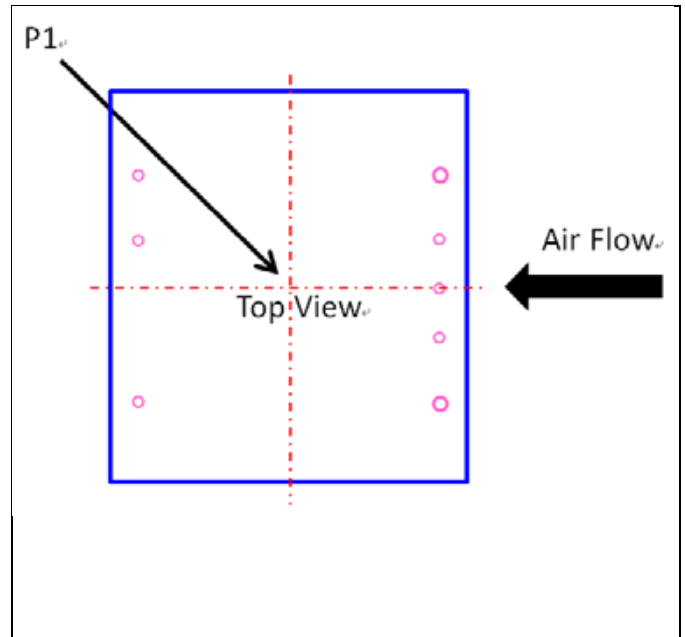

Base plate

## Technical Specification

**PKJ8200 series DC-DC Converters**  
 Input 9-75 V, Output up to 16.7 A / 200 W

28701-BMR7148200 Rev B      October 2023

© Flex

## Connections

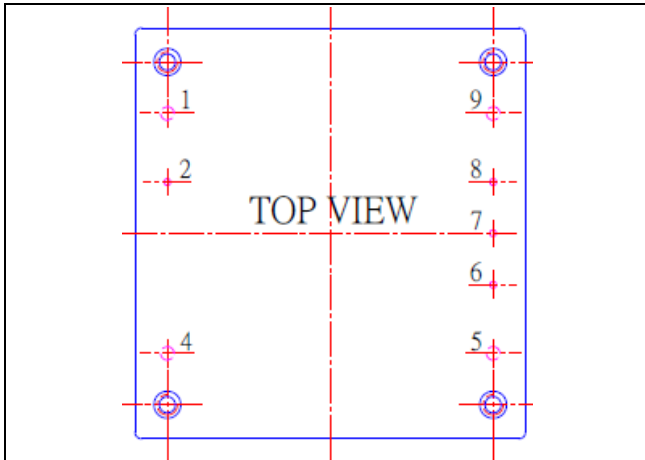

Pin	Designation	Function
1	+In	Positive input
2	RC	Remote control
4	-In	Negative input
5	-Out	Negative output
6	-Sense	Negative remote sense
7	V <sub>adj</sub>	Output voltage adjust
8	+Sense	Positive remote sense
9	+Out	Positive output

Technical Specification

**PKJ8200 series DC-DC Converters**  
 Input 9-75 V, Output up to 16.7 A / 200 W

28701-BMR7148200 Rev B      October 2023  
 © Flex

**Mechanical Information - Enclosure Type**

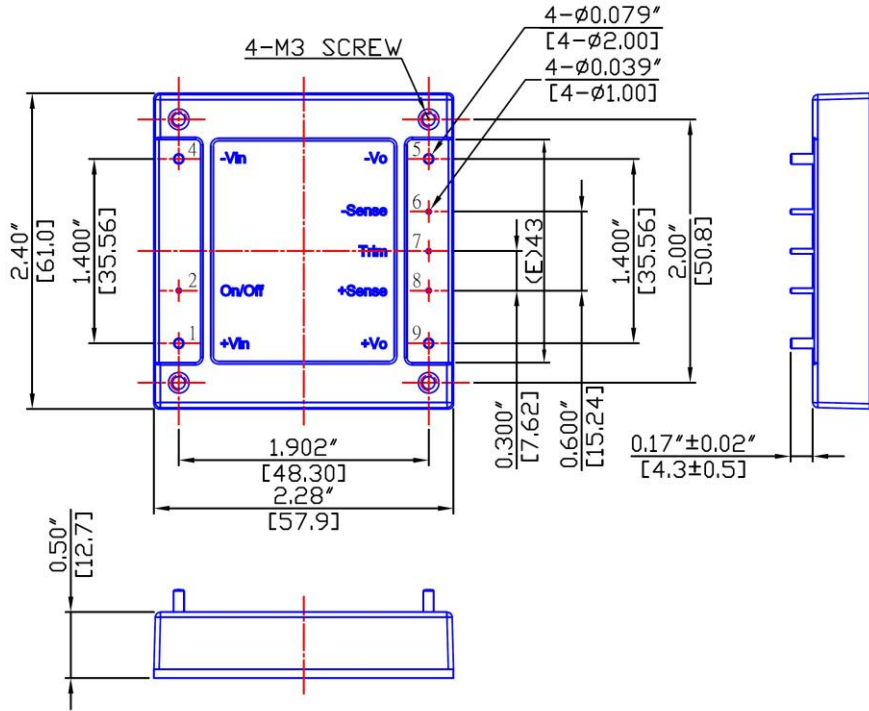

Notes:

1.Pins:

Material: Copper alloy

Plating: Matte Tin over Nickle plate

2.Weight: typical 110g

All dimensions in inches (mm).

Tolerance .xx= ±0.02"

.xxx=±0.010"

3. The screw locked torque: MAX 4.0kgfcm/0.39N-m

All component placements – whether shown as physical components or symbolical outline – are for reference only and are subject to change throughout the product's life cycle, unless explicitly described and dimensioned in this drawing.

Technical Specification

**PKJ8200 series DC-DC Converters**  
 Input 9-75 V, Output up to 16.7 A / 200 W

28701-BMR7148200 Rev B      October 2023  
 © Flex

**Recommended Footprint**

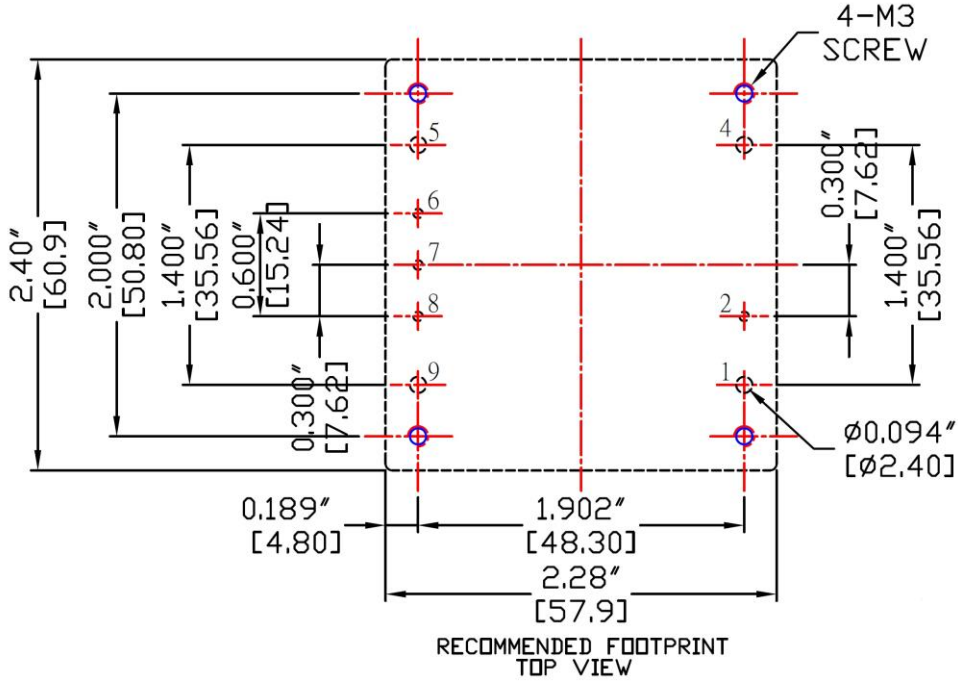

Technical Specification

**PKJ8200 series DC-DC Converters**  
 Input 9-75 V, Output up to 16.7 A / 200 W

28701-BMR7148200 Rev B      October 2023  
 © Flex

**Soldering Information - Hole Mounting**

The hole mounted product is intended for plated through hole mounting by wave or manual soldering. The pin temperature is specified to maximum to 270°C for maximum 10 seconds.

A maximum preheat rate of 4°C/s and maximum preheat temperature of 150°C is suggested. When soldering by hand, care should be taken to avoid direct contact between the hot soldering iron tip and the pins for more than a few seconds in order to prevent overheating.

A no-clean flux is recommended to avoid entrapment of cleaning fluids in cavities inside the product or between the product and the host board. The cleaning residues may affect long time reliability and isolation voltage.

**Delivery Package Information**

The products are delivered in antistatic clamshell trays

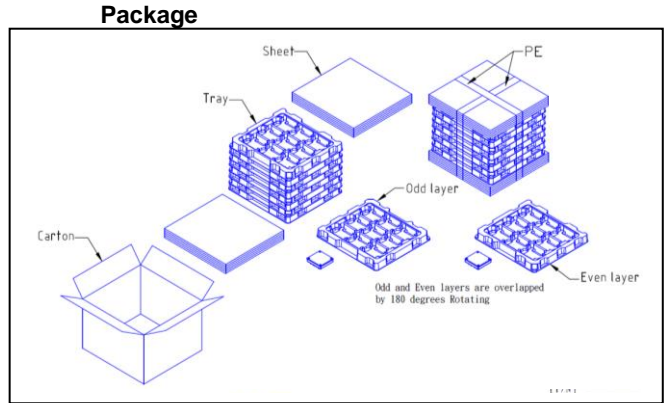

Tray Specifications	
<b>Material</b>	Antistatic PS
<b>Surface resistance</b>	$10^7 < \text{Ohm/square} < 10^{11}$
<b>Bake ability</b>	This tray is not bakeable
<b>Tray thickness</b>	26 mm [1.0236 inch]
<b>Box capacity</b>	72 products (8 full trays/box)
<b>Tray weight</b>	80 g empty, 980g full tray

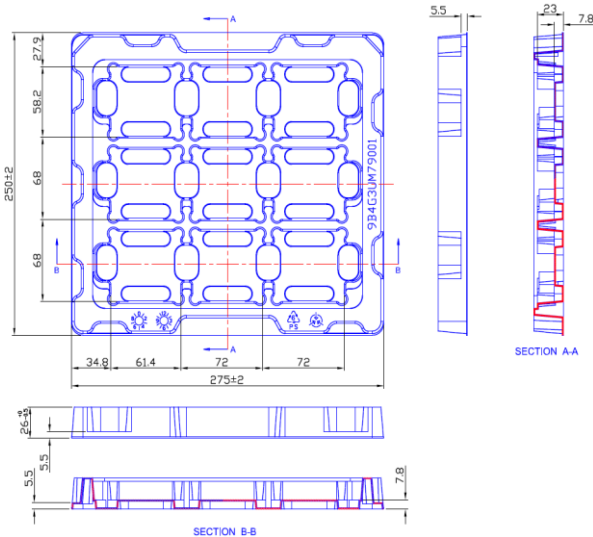

## Technical Specification

<b>PKJ8200 series DC-DC Converters</b> Input 9-75 V, Output up to 16.7 A / 200 W	28701-BMR7148200 Rev B	October 2023
	© Flex	

## Product Qualification Specification

Characteristics			
External visual inspection	IPC-A-610		
Change of temperature (Temperature cycling)	IEC 60068-2-14 Na	Temperature range Number of cycles Dwell/transfer time	-55 to 105°C 20 30 min/3 min
Cold (in operation)	IEC 60068-2-1 Ad	Temperature T <sub>A</sub> Duration	-40°C 72 h
Damp heat	IEC 60068-2-30	Temperature Humidity Duration	45°C 95 % RH 72 hours
Dry heat	IEC 60068-2-2 Bd	Temperature Duration	125°C 1000 h
Electrostatic discharge susceptibility	IEC 61340-3-1, JESD 22-A114	Human body model (HBM)	Class 2, 2000 V
Mechanical shock	IEC 60068-2-27 Ea	Peak acceleration Duration	200 g 6 ms
Moisture reflow sensitivity <sup>1</sup>	J-STD-020E	Level 1 (SnPb-eutectic) Level 3 (Pb Free)	225°C 260°C
Operational life test	MIL-STD-202G, method 108A	Duration	1000 h
Resistance to soldering heat	IEC 60068-2-20 Tb, method 1A	Solder temperature Duration	270°C 10-13 s
Robustness of terminations	IEC 60068-2-21 Test Ua1	Through hole mount products	All leads
Solderability	IEC 60068-2-20 test Ta <sup>1</sup>	Preconditioning Temperature, SnPb Eutectic Temperature, Pb-free	235°C 245°C
Vibration, broad band random	IEC 61373	Frequency RMS acceleration Duration	5 to 150 Hz 5 grms 5 hrs in each direction

## Notes

<sup>1</sup> Only for products intended for wave soldering (plated through hole products)

# Mouser Electronics

Authorized Distributor

Click to View Pricing, Inventory, Delivery & Lifecycle Information:

[Flex:](#)

[PKJ8213PI](#) [PKJ8216HPI](#) [PKJ8216JPI](#) [PKJ8216ZPI](#)