



A Product Line of
Diodes Incorporated



SPECIFICATION FOR APPROVAL

CUSTOMER _____

NOMINAL FREQUENCY 135.000000 MHz



PRODUCT TYPE TYPE NX 3.2x2.5 SEAM SEALED CRYSTAL CLOCK OSCILLATOR

SPEC. NO. (P/N) NX33D5001Q

CUSTOMER P/N _____

ISSUE DATE February 27, 2018

VERSION A

APPROVED	PREPARED	QA
		

Diodes Incorporated

No.2, Ziqiang 5th Rd., Zhongli Industrial Park,
Zhongli Dist., Taoyuan City 32063, Taiwan (R.O.C.)
TEL: 886-3-451-8888
FAX: 886-3-461-3865
<https://www.diodes.com>

- *Pb-free
- *RoHS Compliant
- *HF-Halogen Free
- *REACH Compliant
- *AEC-Q200 Compliant

TYPE NX 3.2x2.5 SEAM SEALED CRYSTAL CLOCK OSCILLATOR

NX33D5001Q

VER. A 27-Feb-18

VERSION HISTORY

Version No.	Version Date	Description	Notes
A	Feb.27,2018	Initial Release	



TYPE NX 3.2x2.5 SEAM SEALED CRYSTAL CLOCK OSCILLATOR

NX33D5001Q

VER. A 27-Feb-18

ELECTRICAL SPECIFICATIONS

SRe Part Number : NX33D5001Q

Item	Symbol	Specifications	Units	Notes
Nominal Frequency	F ₀	135.000000	MHz	
Frequency Stability	FT	± 50	ppm	**See note
Operating Temperature Range	TR	-40 to +85	°C	
Supply Voltage	V _{CC}	+3.3 ± 5.0%	V	
Logic Type	LT	LVDS		
Supply Current, Output Enabled	I _{CC/OE}	70	mA	Max.
Supply Current, Output Disabled	I _{CC/OD}	40	mA	Max.
Duty Cycle (Symmetry)	DC/SY	45 / 55	%	Measured 50% of Waveform
Rise / Fall Time	T _R /T _F	0.4	ns	Max. measured 20/80% of Waveform
Output Voltage "0" Level	V _{OL}	1.10 / 0.9	V	Typ. / Min.
Output Voltage "1" Level	V _{OH}	1.43 / 1.6	V	Typ. / Max.
Output Load		100Ω connected between outputs		Output requires termination
Differential Output Voltage	V _{OD}	247 / 454	mV	Min. / Max.
Jitter, Phase	RMS	1	ps	Max. 12kHz ~ 20MHz Frequency Band
Jitter, Accumulated	RMS(1-σ)	6	ps	Max. 20,000 Consecutive Periods
Jitter, Peak to Peak	Pk-Pk	40	ps	Max. 100,000 Random Periods
Storage Temperature Range		-55 to +125	°C	

※ This product doesn't include harmful substance that stipulated by SONY SS-00259 Level 1 and S-AT2-001 Level 1 standard. RoHS Compliant (Pb - Free).

**Stability includes all combinations of Operating Temperature, Load changes, rated Input (Supply) Voltage changes, Initial Calibration Tolerance (25°C), Aging (1 year at 25°C Average Effective Ambient Temperature), Shock and Vibration.

Output Enable / Disable Function

Parameter	Min.	Typ.	Max.	Units	Notes
Input Voltage (Pin1), Output Enable	0.7V _{CC}			V	Or Open
Input Voltage (Pin1), Output Disable (low power standby)			0.3V _{CC}	V	Output is Hi-Z
Output Disable Delay			100	ns	
Output Enable Delay			100	ns	
Start Up Time			10	ms	



TYPE NX 3.2x2.5 SEAM SEALED CRYSTAL CLOCK OSCILLATOR

NX33D5001Q

VER. A 27-Feb-18

TEST CIRCUIT

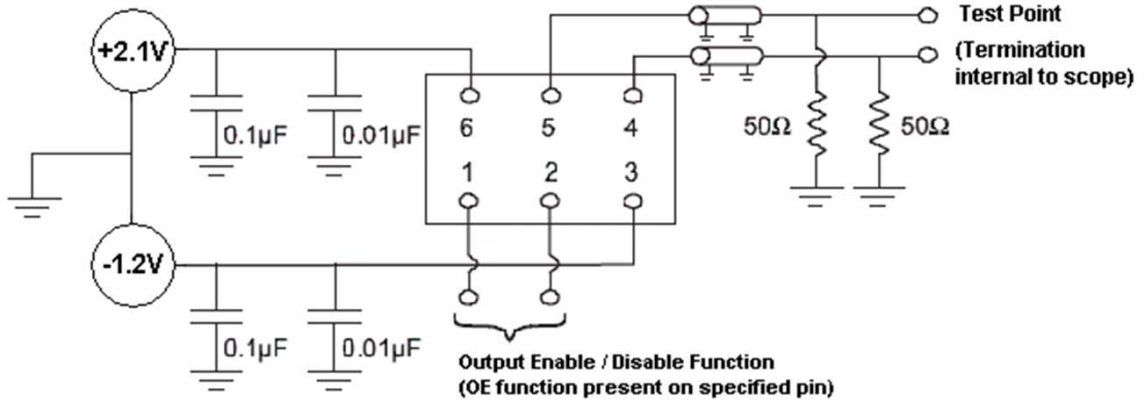

OUTPUT WAVEFORM

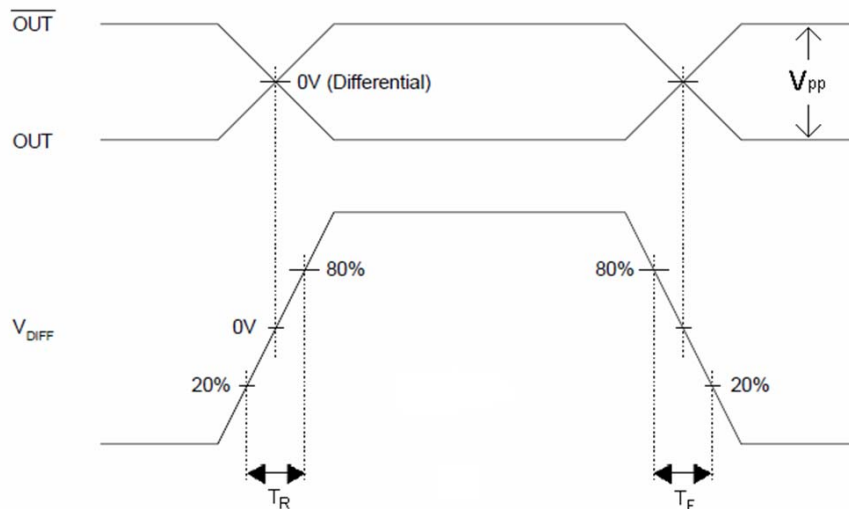
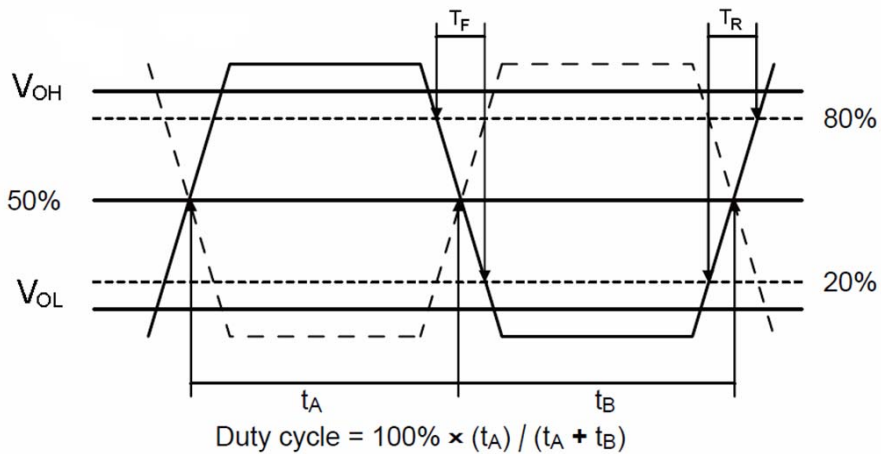

TYPE NX 3.2x2.5 SEAM SEALED CRYSTAL CLOCK OSCILLATOR

NX33D5001Q

VER. A 27-Feb-18

AEC-Q200 RELIABILITY TEST SPECIFICATIONS:

1. Initial

- 1.1 Physical Dimensions: JESD22, Method JB1-100
- 1.2 External Visual: MIL-STD-883, Method 2009
- 1.3 Freq. Vs. Temperature: Per Specification/Datasheet

2. Mechanical

- 2.1 Mechanical Shock: MIL-STD-202 Method 213
- 2.2 Vibration: MIL-STD-202 Method 204
- 2.3 Solderability: J-STD-002
- 2.4 Board Flex: AEC Q200-005
- 2.5 Terminal Strength (SMD): AEC Q200-006

3.Environmental

- 3.1 Temp Cycle: JESD22, Method JA-104
- 3.2 Resistance to Solder Heat: MIL-STD-202 Method 210
- 3.3 High Temperature Operating Life: MIL-STD-202, Method 108
- 3.4 High Temp Exposure: MIL-STD-202, Method 108
- 3.5 High Temp & High humidity: MIL-STD-202, Method 103
- 3.6 Thermal Shock: MIL-STD-202, Method 107

SUGGESTED IR REFLOW PROFILE

*As per IPC-JEDEC J-STD-020D

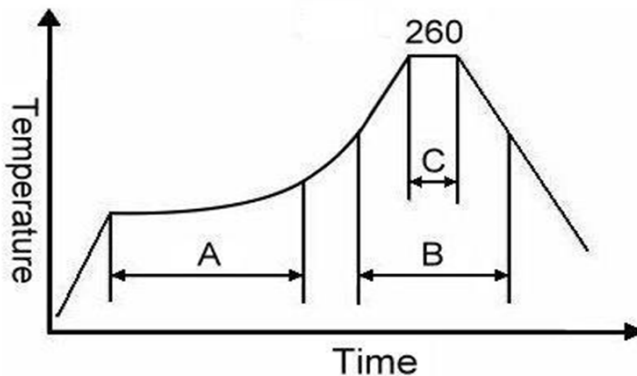

Note:

	Stage	Temperature	Time
A	Preheat	150~200°C	60~120 Sec
B	Primary Heat	217°C	60~150 Sec
C	Peak	260°C	10 Sec

TYPE NX 3.2x2.5 SEAM SEALED CRYSTAL CLOCK OSCILLATOR

NX33D5001Q

VER. A 27-Feb-18

MARKING

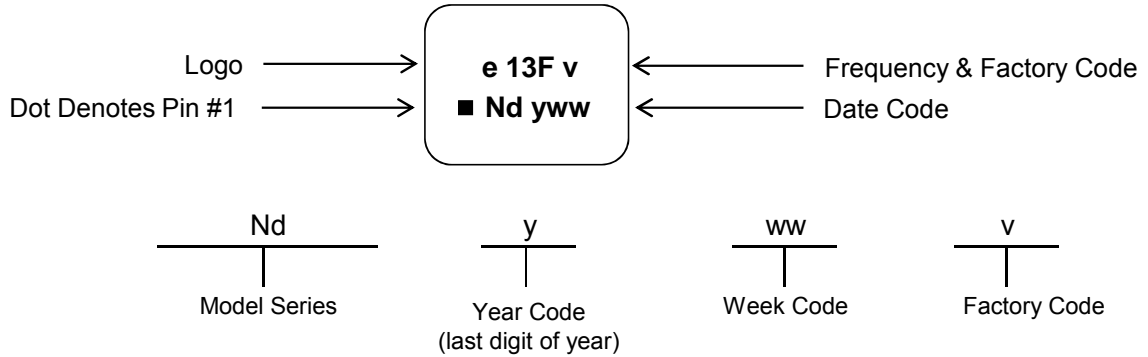

MECHANICAL DRAWINGS (Scale: None. Dimensions are in mm.)

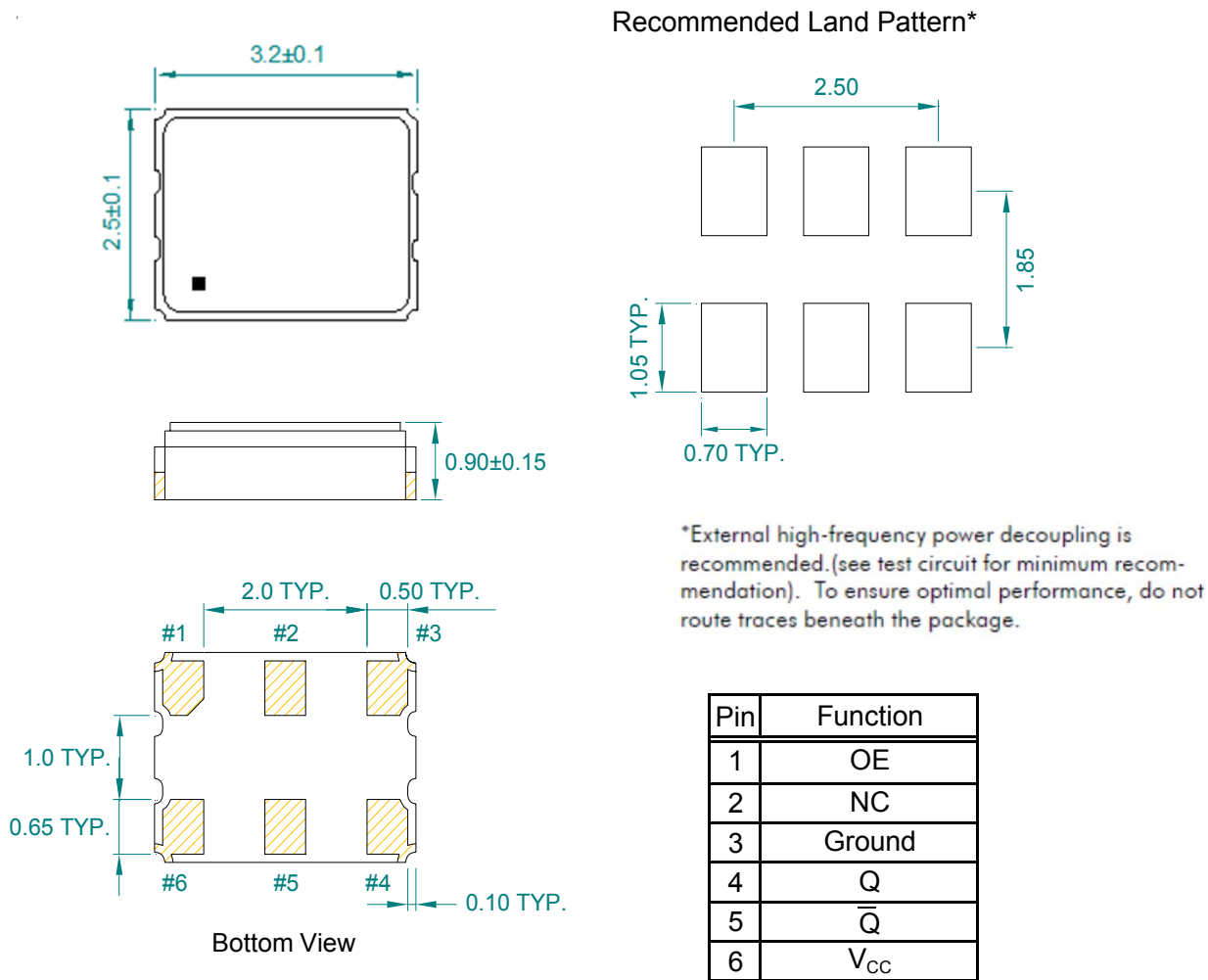

TYPE NX 3.2x2.5 SEAM SEALED CRYSTAL CLOCK OSCILLATOR

NX33D5001Q

VER. A 27-Feb-18

TAPE & REEL

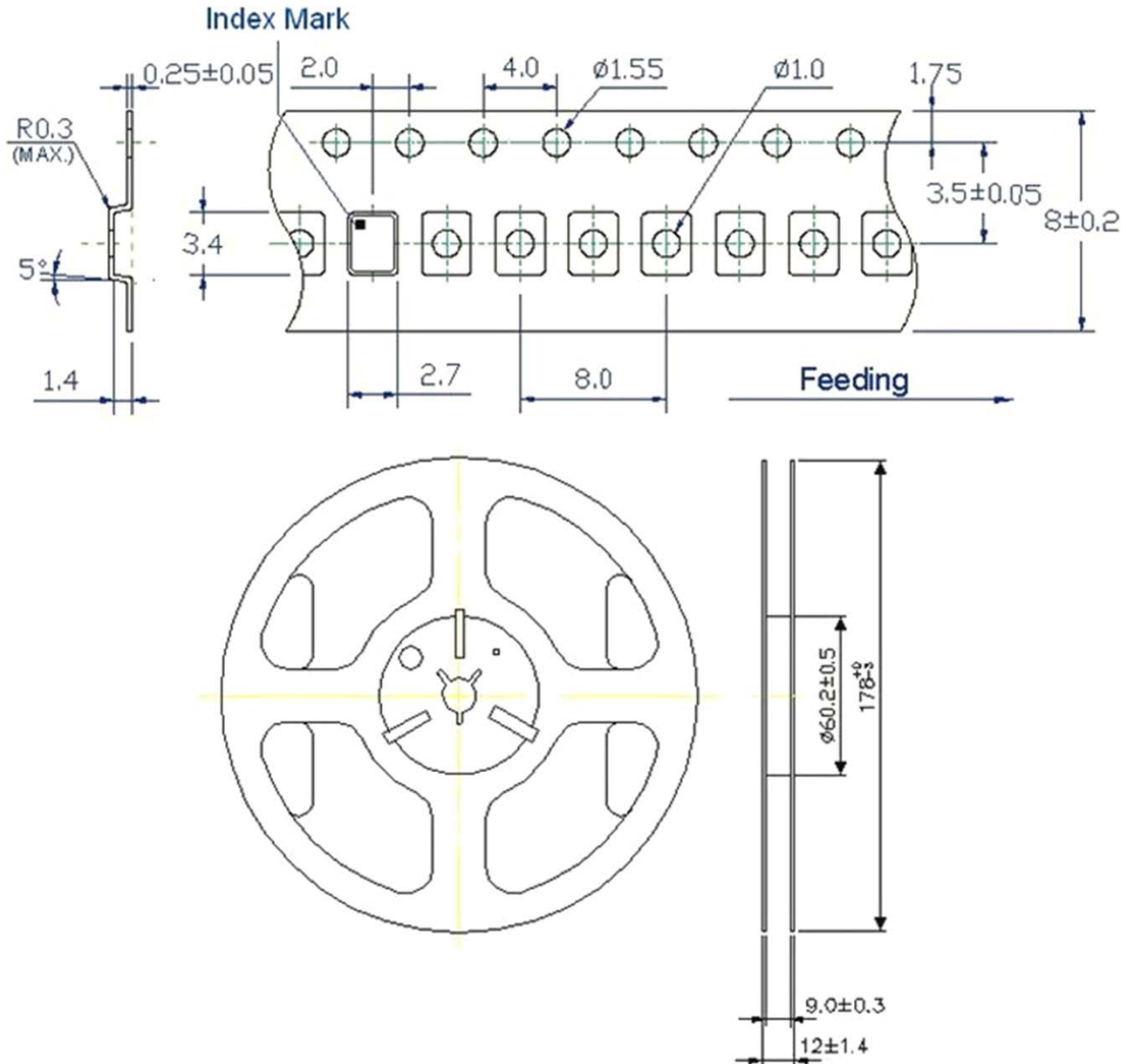

1. 230mm minimum leader which consist of carrier and/or tape followed by a minimum of 160mm of empty carrier tape sealed with cover tape.
2. 160mm minimum trailer of empty carrier tape sealed with cover tape.

TYPE NX 3.2x2.5 SEAM SEALED CRYSTAL CLOCK OSCILLATOR

NX33D5001Q

VER. A 27-Feb-18

PACKING

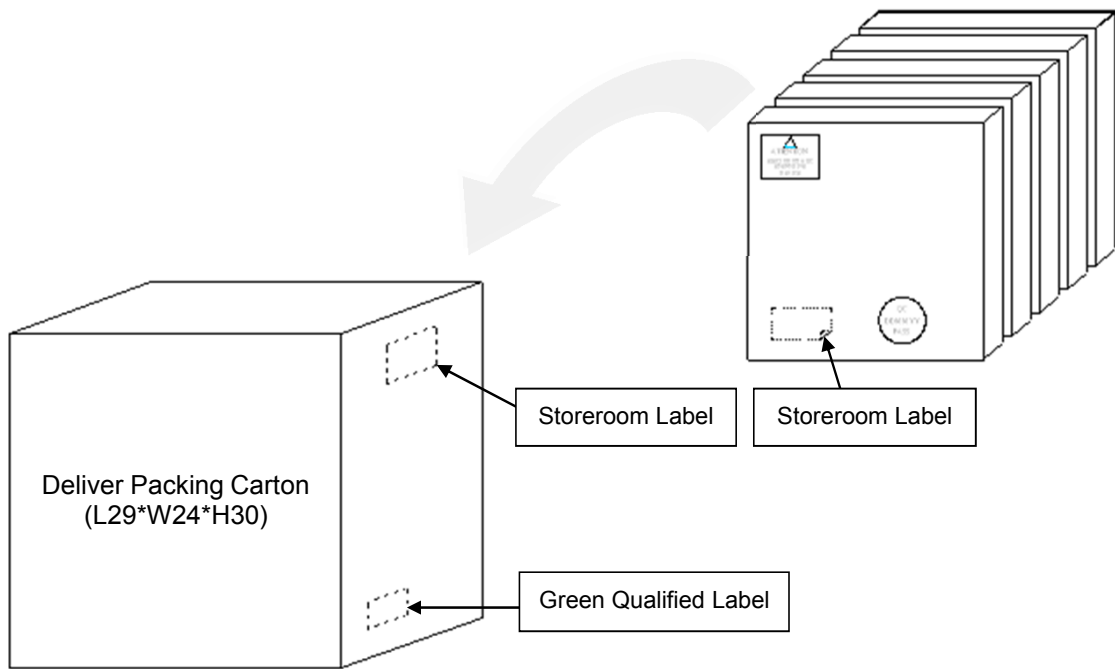
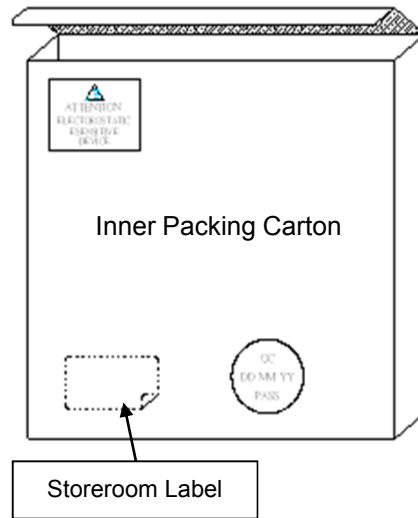
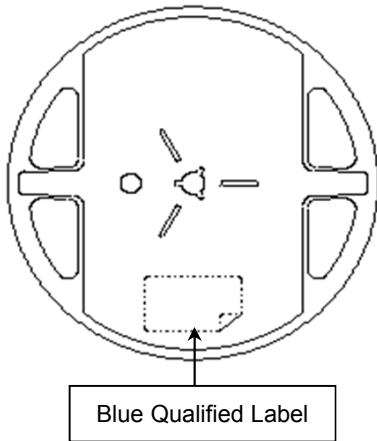
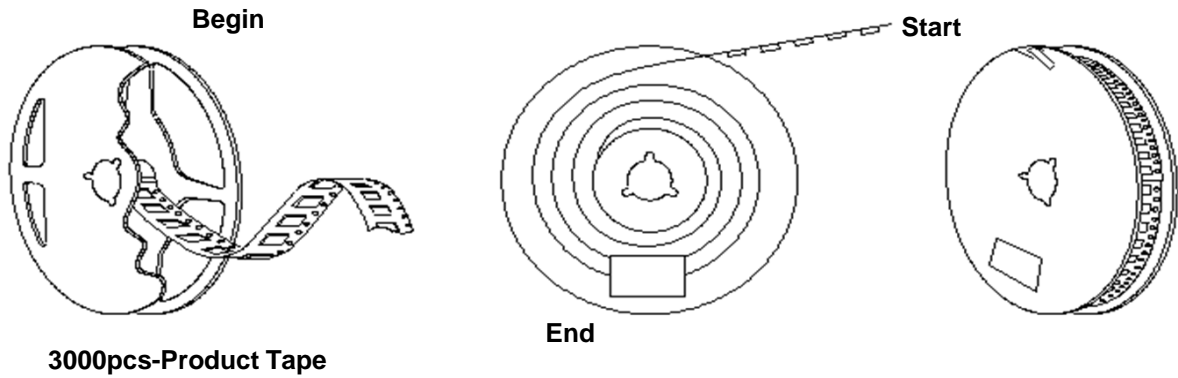

Mouser Electronics

Authorized Distributor

Click to View Pricing, Inventory, Delivery & Lifecycle Information:

[Diodes Incorporated:](#)

[NX33D5001Q](#)