

Description

The AZ1084C is a series of low-dropout positive-voltage regulators with a maximum dropout of 1.5V at 5A of load current.

The series features on-chip thermal limiting, which provides protection against any combination of overload and ambient temperatures that would create excessive junction temperatures. It also includes a trimmed bandgap reference and a current-limiting circuit.

The AZ1084C is available in 1.5V, 1.8V, 2.5V, 3.3V and 5.0V versions. The fixed versions integrate the adjust resistors. It is also available in an adjustable version which can set the output voltage with two external resistors.

The AZ1084C series is available in the standard packages of TO252-2 (3), TO252-2 (4), TO252-2 (5) and TO252 (Type CJ).

Features

- Low Dropout Voltage: 1.35V typical at 5A
- Current Limiting and Thermal Protection
- Output Current: 5A
- Current Limit: 6.5A
- Operating Junction Temperature Range: 0°C to +125°C
- Compatible with Low ESR Ceramic Capacitor
- Line Regulation (Adj Version): 0.015% (typ)
- Load Regulation (Adj Version): 0.1% (typ)
- **Totally Lead-Free & Fully RoHS Compliant (Notes 1 & 2)**
- **Halogen and Antimony Free. "Green" Device (Note 3)**
- **For automotive applications requiring specific change control (i.e. parts qualified to AEC-Q100/101/104/200, PPAP capable, and manufactured in IATF 16949 certified facilities), please [contact us](mailto:contact_us) or your local Diodes representative. <https://www.diodes.com/quality/product-definitions/>**

Applications

- High-efficiency linear regulators
- Battery chargers
- Post-regulation for switching supplies
- Microprocessor supplies
- Desktop PCs, RISC and embedded processors' supplies

Notes: 1. No purposely added lead. Fully EU Directive 2002/95/EC (RoHS), 2011/65/EU (RoHS 2) & 2015/863/EU (RoHS 3) compliant.
2. See <https://www.diodes.com/quality/lead-free/> for more information about Diodes Incorporated's definitions of Halogen- and Antimony-free, "Green" and Lead-free.
3. Halogen- and Antimony-free "Green" products are defined as those which contain <900ppm bromine, <900ppm chlorine (<1500ppm total Br + Cl) and <1000ppm antimony compounds.

Pin Assignments

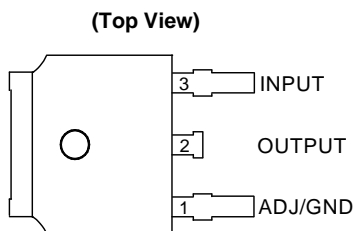

TO252-2 (3) Option 1

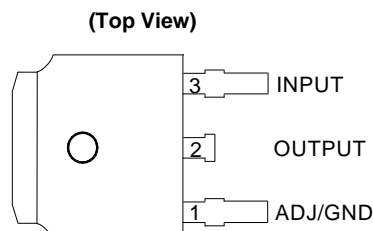

TO252-2 (3) Option 2 / TO252 (Type CJ)

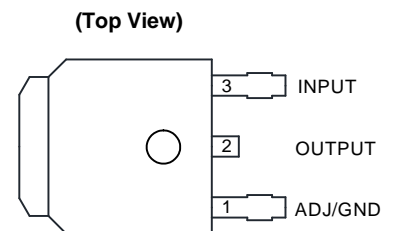

TO252-2 (4)

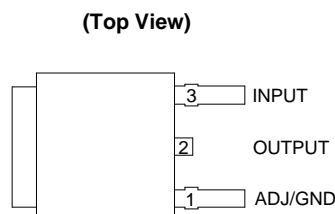

TO252-2 (5)

Typical Applications Circuit

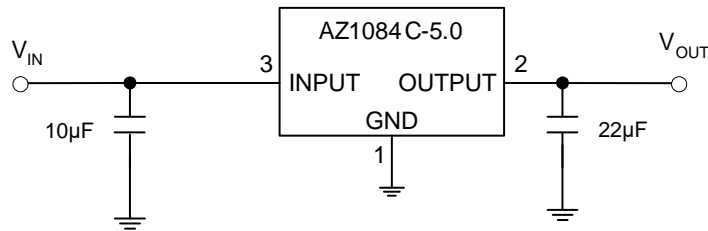
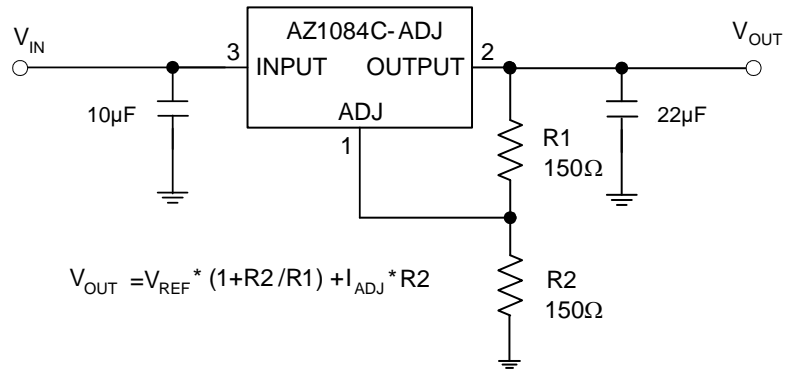

Functional Block Diagram

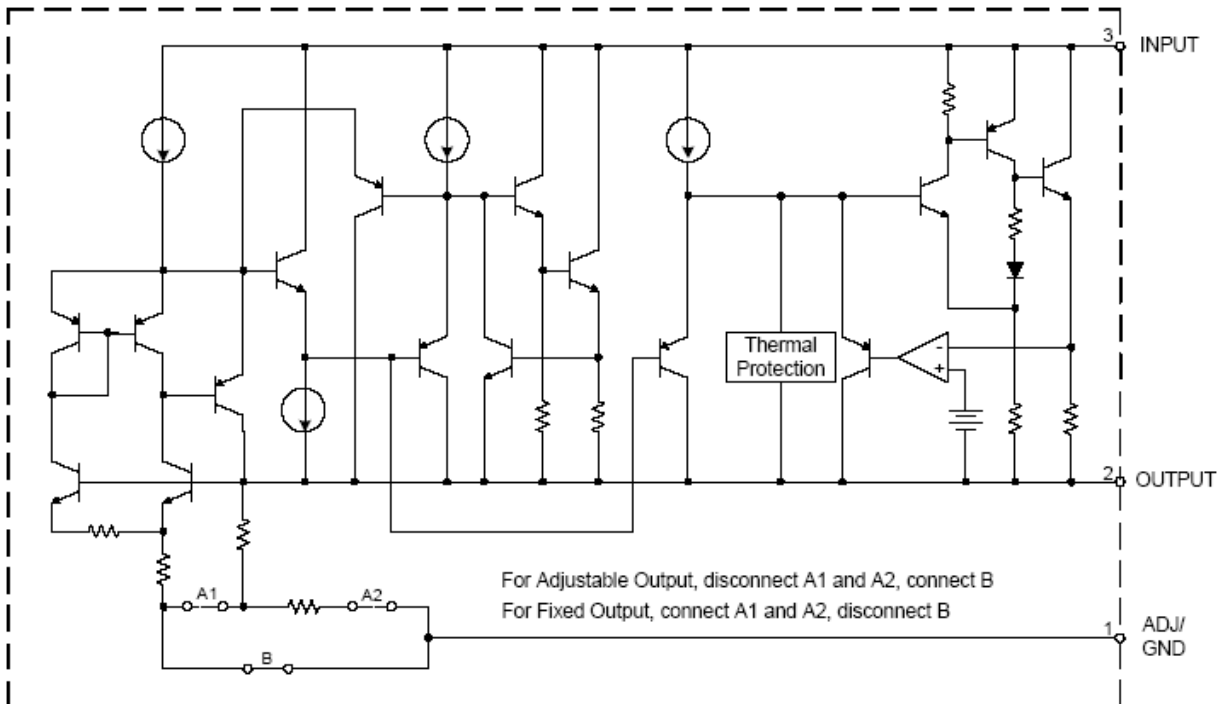

Absolute Maximum Ratings (Note 4)

Symbol	Parameter	Rating	Unit
V _{IN}	Input Voltage	13.2	V
T _J	Operating Junction Temperature	+150	°C
T _{STG}	Storage Temperature Range	-65 to +150	°C
T _{LEAD}	Lead Temperature (Soldering, 10sec.)	+260	°C
θ _{JA}	Thermal Resistance (Note 5)	100	°C/W
ESD	ESD (Human Body Model)	2000	V
ESD	ESD (Machine Model)	400	V

- Notes:
- Stresses greater than those listed under “*Absolute Maximum Ratings*” can cause permanent damage to the device. These are stress ratings only, and functional operation of the device at these or any other conditions beyond those indicated under “*Recommended Operating Conditions*” is not implied. Exposure to “*Absolute Maximum Ratings*” for extended periods can affect device reliability.
 - Absolute maximum ratings indicate limits beyond which damage to the component may occur. Electrical specifications do not apply when operating the device outside of its operating ratings. The maximum allowable power dissipation is a function of the maximum junction temperature, T_{J(MAX)}, the junction to-ambient thermal resistance, θ_{JA}, and the ambient temperature, T_A. The maximum allowable power dissipation at any ambient temperature is calculated using: P_{D(MAX)} = (T_{J(MAX)} - T_A)/θ_{JA}. Exceeding the maximum allowable power dissipation will result in excessive die temperature, and the regulator will go into thermal shutdown.

Recommended Operating Conditions

Symbol	Parameter	Min	Max	Unit
V _{IN}	Input Voltage	—	12	V
T _J	Operating Junction Temperature Range	0	+125	°C

Electrical Characteristics (Typicals and limits appearing in normal type apply for $T_J = +25^\circ\text{C}$. Limits appearing in **Boldface** type apply over the entire operating junction temperature range.)

Symbol	Parameter	Conditions	Min	Typ	Max	Unit
V_{REF}	Reference Voltage	AZ1084C-ADJ, $I_{OUT} = 10\text{mA}$, $V_{IN}-V_{OUT} = 3\text{V}$, $10\text{mA} \leq I_{OUT} \leq 5\text{A}$, $1.5\text{V} \leq V_{IN}-V_{OUT} \leq 5\text{V}$	1.238 1.225	1.250 1.250	1.262 1.270	V
V_{OUT}	Output Voltage	AZ1084C-1.5, $I_{OUT} = 0\text{mA}$, $V_{IN} = 4.5\text{V}$, $10\text{mA} \leq I_{OUT} \leq 5\text{A}$, $3.0\text{V} \leq V_{IN} \leq 6\text{V}$	1.485 1.47	1.5 1.5	1.515 1.53	V
		AZ1084C-1.8, $I_{OUT} = 0\text{mA}$, $V_{IN} = 4.8\text{V}$, $10\text{mA} \leq I_{OUT} \leq 5\text{A}$, $3.3\text{V} \leq V_{IN} \leq 6\text{V}$	1.782 1.764	1.8 1.8	1.818 1.836	V
		AZ1084C-2.5, $I_{OUT} = 0\text{mA}$, $V_{IN} = 5.5\text{V}$, $10\text{mA} \leq I_{OUT} \leq 5\text{A}$, $4.0\text{V} \leq V_{IN} \leq 7\text{V}$	2.475 2.45	2.5 2.5	2.525 2.55	V
		AZ1084C-3.3, $I_{OUT} = 0\text{mA}$, $V_{IN} = 6.3\text{V}$, $10\text{mA} \leq I_{OUT} \leq 5\text{A}$, $4.8\text{V} \leq V_{IN} \leq 8\text{V}$	3.267 3.234	3.3 3.3	3.333 3.366	V
		AZ1084C-5.0, $I_{OUT} = 0\text{mA}$, $V_{IN} = 8\text{V}$, $10\text{mA} \leq I_{OUT} \leq 5\text{A}$, $6.5\text{V} \leq V_{IN} \leq 10\text{V}$	4.95 4.9	5 5	5.05 5.1	V
ΔV_{OUT}	Line Regulation	AZ1084C-ADJ, $I_{OUT} = 10\text{mA}$, $2.85\text{V} \leq V_{IN} \leq 10\text{V}$	—	0.015 0.035	0.2	%
		AZ1084C-1.5, $I_{OUT} = 10\text{mA}$, $3.0\text{V} \leq V_{IN} \leq 10\text{V}$	—	0.5 1	6 6	mV
		AZ1084C-1.8, $I_{OUT} = 10\text{mA}$, $3.3\text{V} \leq V_{IN} \leq 10\text{V}$	—	0.5 1	6 6	mV
		AZ1084C-2.5, $I_{OUT} = 10\text{mA}$, $4.0\text{V} \leq V_{IN} \leq 10\text{V}$	—	0.5 1	6 6	mV
		AZ1084C-3.3, $I_{OUT} = 10\text{mA}$, $4.8\text{V} \leq V_{IN} \leq 10\text{V}$	—	0.5 1	6 6	mV
		AZ1084C-5.0, $I_{OUT} = 10\text{mA}$, $6.5\text{V} \leq V_{IN} \leq 10\text{V}$	—	0.5 1	10 10	mV
		AZ1084C-ADJ, $0\text{mA} \leq I_{OUT} \leq 5\text{A}$, $V_{IN}-V_{OUT} = 3\text{V}$	—	0.1 0.2	0.3 0.4	%
ΔV_{OUT}	Load Regulation	AZ1084C-1.5, $0\text{mA} \leq I_{OUT} \leq 5\text{A}$, $V_{IN}-V_{OUT} = 3\text{V}$	—	3 7	15 20	mV
		AZ1084C-1.8, $0\text{mA} \leq I_{OUT} \leq 5\text{A}$, $V_{IN}-V_{OUT} = 3\text{V}$	—	3 7	15 20	mV
		AZ1084C-2.5, $0\text{mA} \leq I_{OUT} \leq 5\text{A}$, $V_{IN}-V_{OUT} = 3\text{V}$	—	3 7	15 20	mV
		AZ1084C-3.3, $0\text{mA} \leq I_{OUT} \leq 5\text{A}$, $V_{IN}-V_{OUT} = 3\text{V}$	—	3 7	15 20	mV
		AZ1084C-5.0, $0\text{mA} \leq I_{OUT} \leq 5\text{A}$, $V_{IN}-V_{OUT} = 3\text{V}$	—	5 10	20 35	mV
		V_{DRO}	Dropout Voltage	$I_{OUT} = 4.5\text{A}$, ΔV_{REF} , $\Delta V_{OUT} = 1\%$	—	1.35
θ_{JC}	Thermal Resistance (Junction to Case)	—	—	7.36	—	$^\circ\text{C}/\text{W}$

Electrical Characteristics (continued. Typical and limits appearing in normal type apply for $T_J = +25^\circ\text{C}$. Limits appearing in **Boldface** type apply over the entire operating junction temperature range.)

Symbol	Parameter	Conditions	Min	Typ	Max	Unit
I_{LIMIT}	Current Limit	$V_{IN}-V_{OUT} = 3V$	5.5	6.5	—	A
$I_{LOAD (MIN)}$	Minimum Load Current	$V_{IN} = 10V$ (AZ1084C-ADJ)	—	3	10	mA
I_Q	Quiescent Current	$V_{IN} = 10V$ (AZ1084C)	—	5	10	mA
PSRR	Ripple Rejection	$f_{RIPPLE} = 120\text{Hz}$, $C_{OUT} = 25\mu\text{F}$ Tantalum, $I_{OUT} = 5A$, $V_{IN}-V_{OUT} = 3V$	60	72	—	dB
I_{ADJ}	Adjust Pin Current	$V_{IN} = 4.25V$, $I_{OUT} = 10\text{mA}$	—	55	120	μA
ΔI_{ADJ}	Adjust Pin Current Change	$10\text{mA} \leq I_{OUT} \leq 5A$, $1.5V \leq (V_{IN}-V_{OUT}) \leq 4.5V$	—	0.2	5	μA
—	Temperature Stability	$I_{OUT} = 10\text{mA}$, $V_{IN}-V_{OUT} = 1.5V$	—	0.5	—	%
—	Long Term Stability	$T_A = +125^\circ\text{C}$, 1000Hrs	—	0.5	—	%
—	RMS Noise (% of V_{OUT})	$10\text{Hz} \leq f \leq 10\text{kHz}$	—	0.003	—	%

Performance Characteristics

Dropout Voltage vs. Output Current

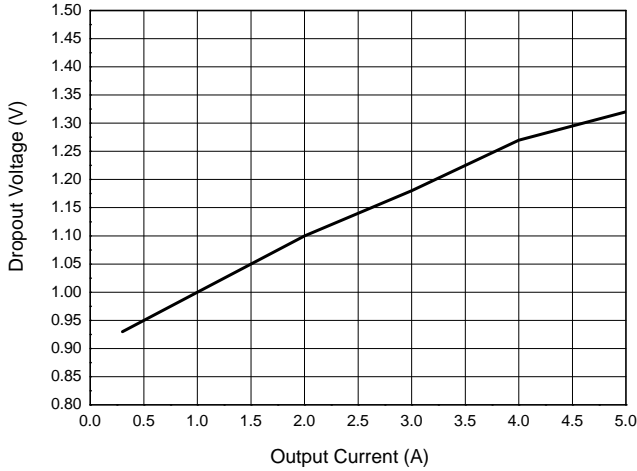

Output Voltage vs. Junction Temperature

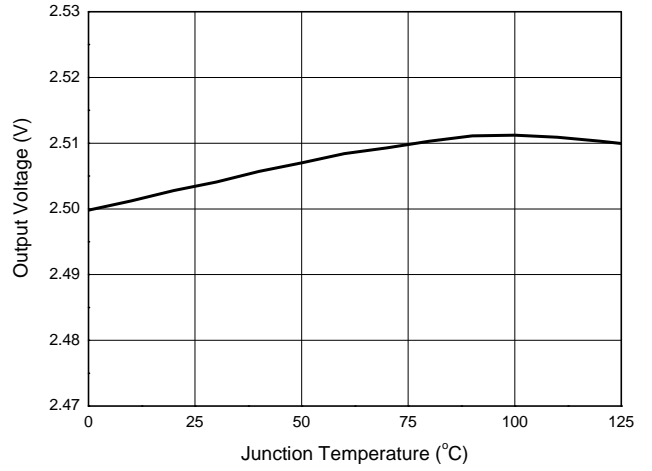

Reference Voltage vs. Junction Temperature

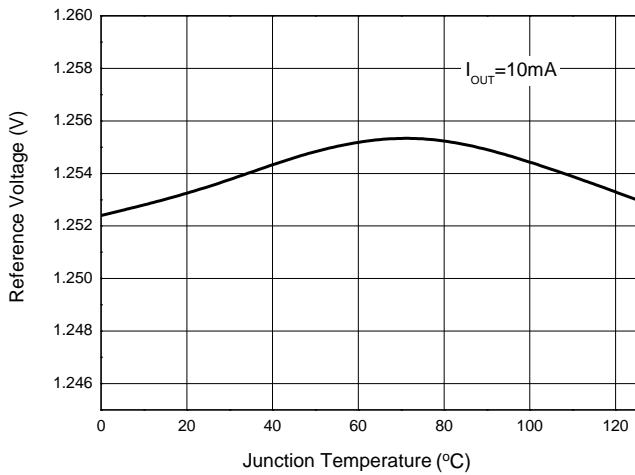

Minimum Load Current vs. Junction Temperature

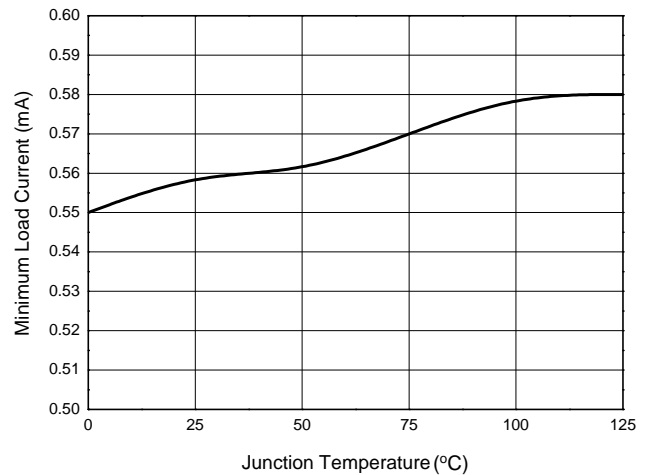

Adjust Pin Current vs. Junction Temperature

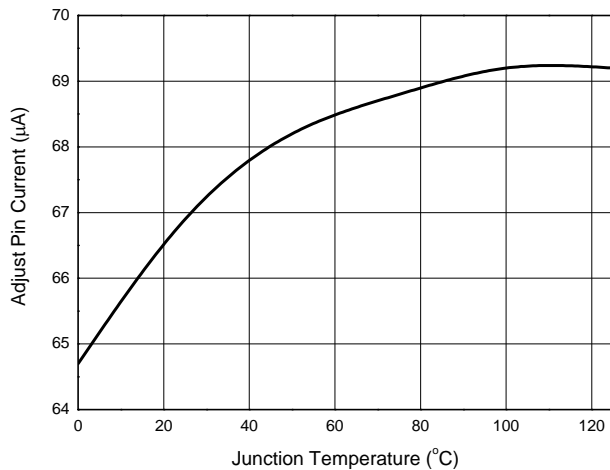

Line Regulation vs. Junction Temperature

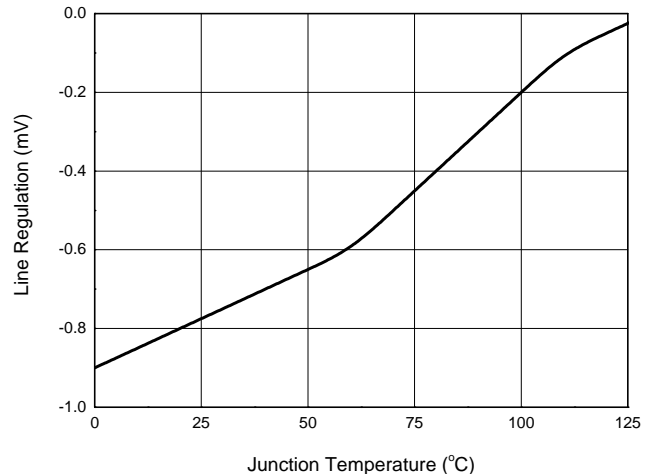

Performance Characteristics (continued)

Adjust Pin Current vs. Output Current

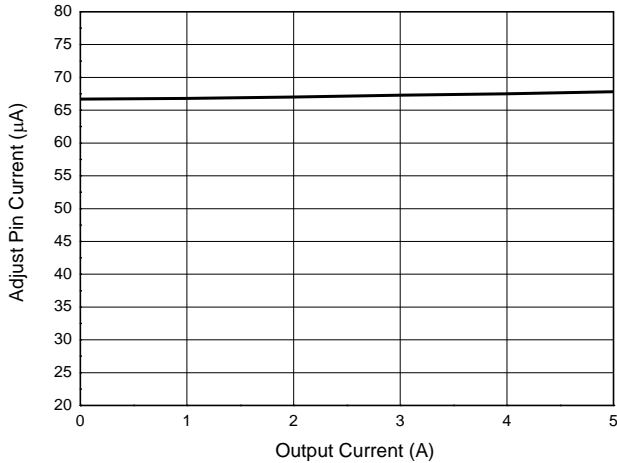

Dropout Voltage vs. Junction Temperature

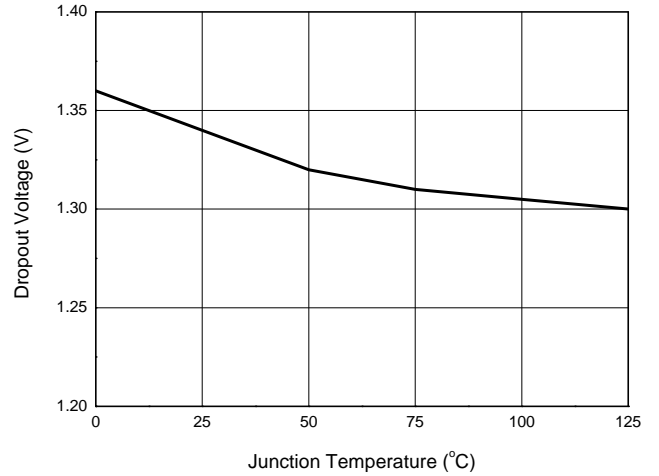

Short Circuit Current vs. Dropout Voltage

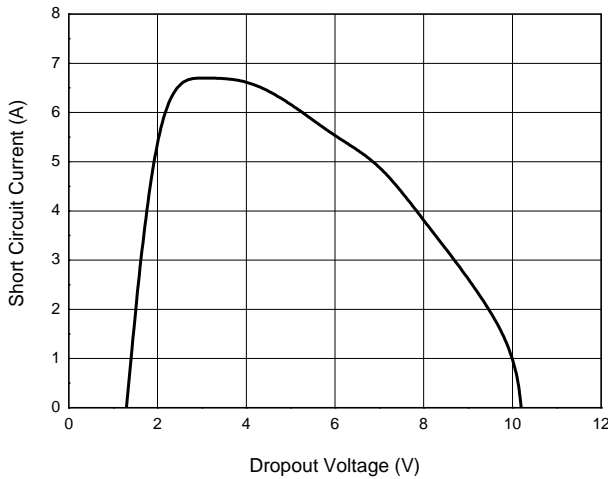

PSRR vs. Frequency

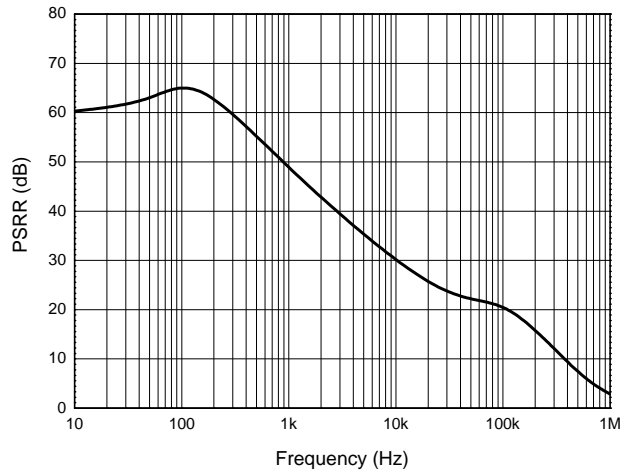

Load Transient Response
(Conditions: $V_{IN} = 5.5V$, $V_{OUT} = 2.5V$,
 $I_{OUT} = 10mA$ to $5A$, $C_{IN} = 10\mu F$, $C_{OUT} = 10\mu F$)

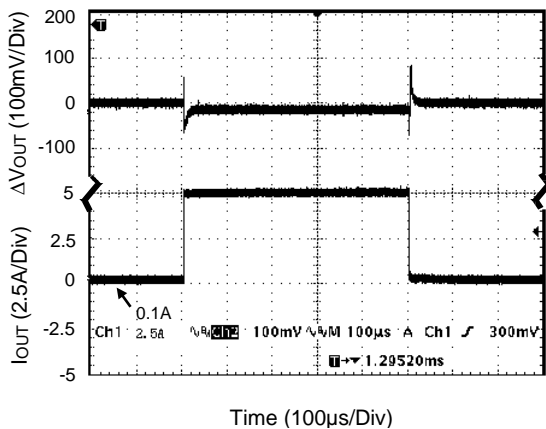

Line Transient Response
(Conditions: $V_{IN} = 4.5V$ to $6.5V$, $V_{OUT} = 2.5V$,
 $I_{OUT} = 200mA$, $C_{OUT} = 10\mu F$)

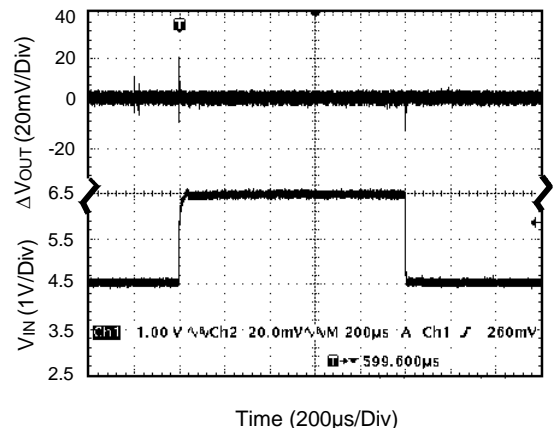

Ordering Information

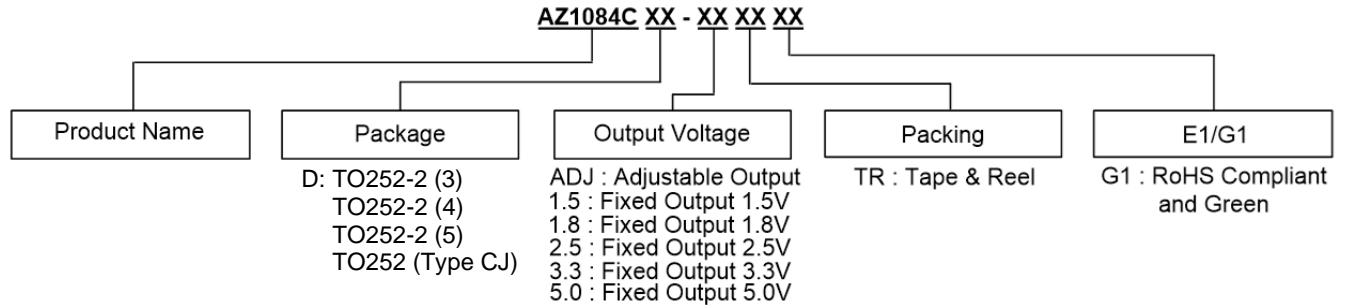

Part Number	Package	Temperature Range	Marking ID	Packing	
			RoHS Compliant and Green	Qty.	Carrier
AZ1084CD-ADJTRG1	TO252-2 (3)/(4)/(5) TO252 (Type CJ)	0°C to +125°C	AZ1084CD-ADJG1	2500	Tape & Reel
AZ1084CD-1.5TRG1	TO252-2 (3)/(4)/(5) TO252 (Type CJ)	0°C to +125°C	AZ1084CD-1.5G1	2500	Tape & Reel
AZ1084CD-1.8TRG1	TO252-2 (3)/(4)/(5) TO252 (Type CJ)	0°C to +125°C	AZ1084CD-1.8G1	2500	Tape & Reel
AZ1084CD-2.5TRG1	TO252-2 (3)/(4)/(5) TO252 (Type CJ)	0°C to +125°C	AZ1084CD-2.5G1	2500	Tape & Reel
AZ1084CD-3.3TRG1	TO252-2 (3)/(4)/(5) TO252 (Type CJ)	0°C to +125°C	AZ1084CD-3.3G1	2500	Tape & Reel
AZ1084CD-5.0TRG1	TO252-2 (3)/(4)/(5) TO252 (Type CJ)	0°C to +125°C	AZ1084CD-5.0G1	2500	Tape & Reel

Marking Information

(1) TO252-2 (3)/TO252-2 (4)/TO252-2 (5)/TO252 (Type CJ)

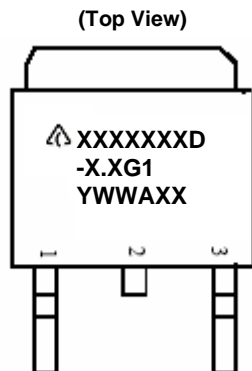

First and Second Lines: Logo and Marking ID
(See Ordering Information)
Third Line: Date Code
Y: Year
WW: Work Week of Molding
A: Assembly House Code
XX: 7th and 8th Digits of Batch Number

Package Outline Dimensions (All dimensions in mm)

Please see <http://www.diodes.com/package-outlines.html> for the latest version.

(1) Package Type: TO252-2 (3)

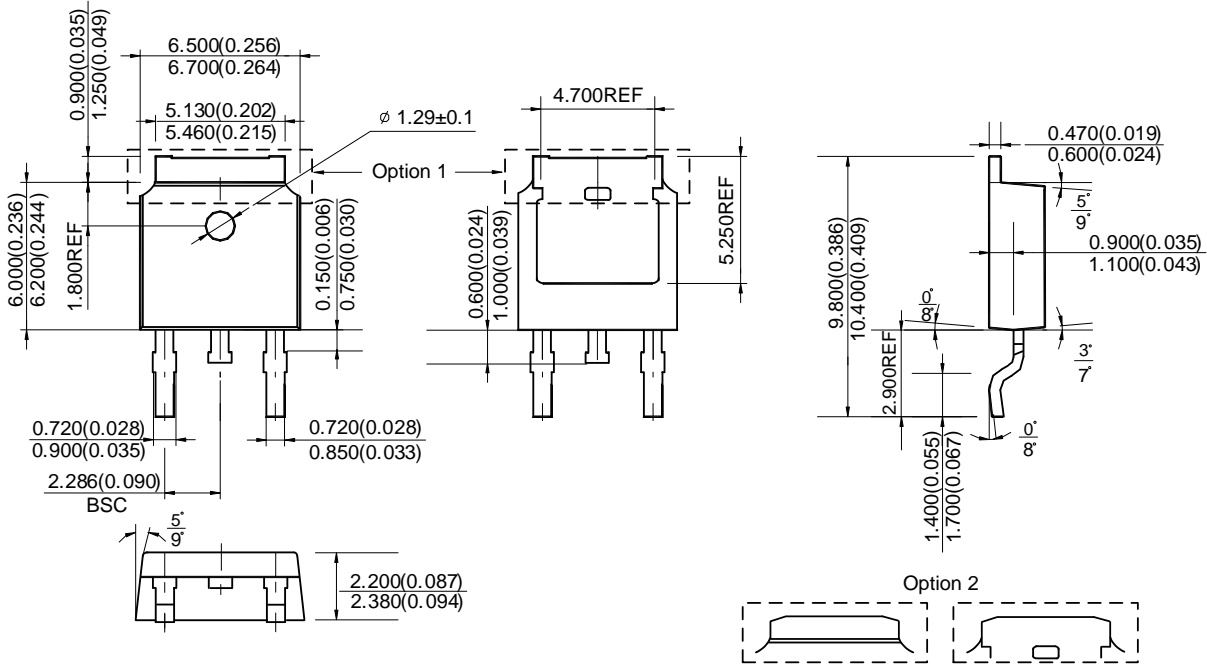

Package Outline Dimensions (All dimensions in mm) (continued)

Please see <http://www.diodes.com/package-outlines.html> for the latest version.

(2) Package Type: TO252-2 (4)

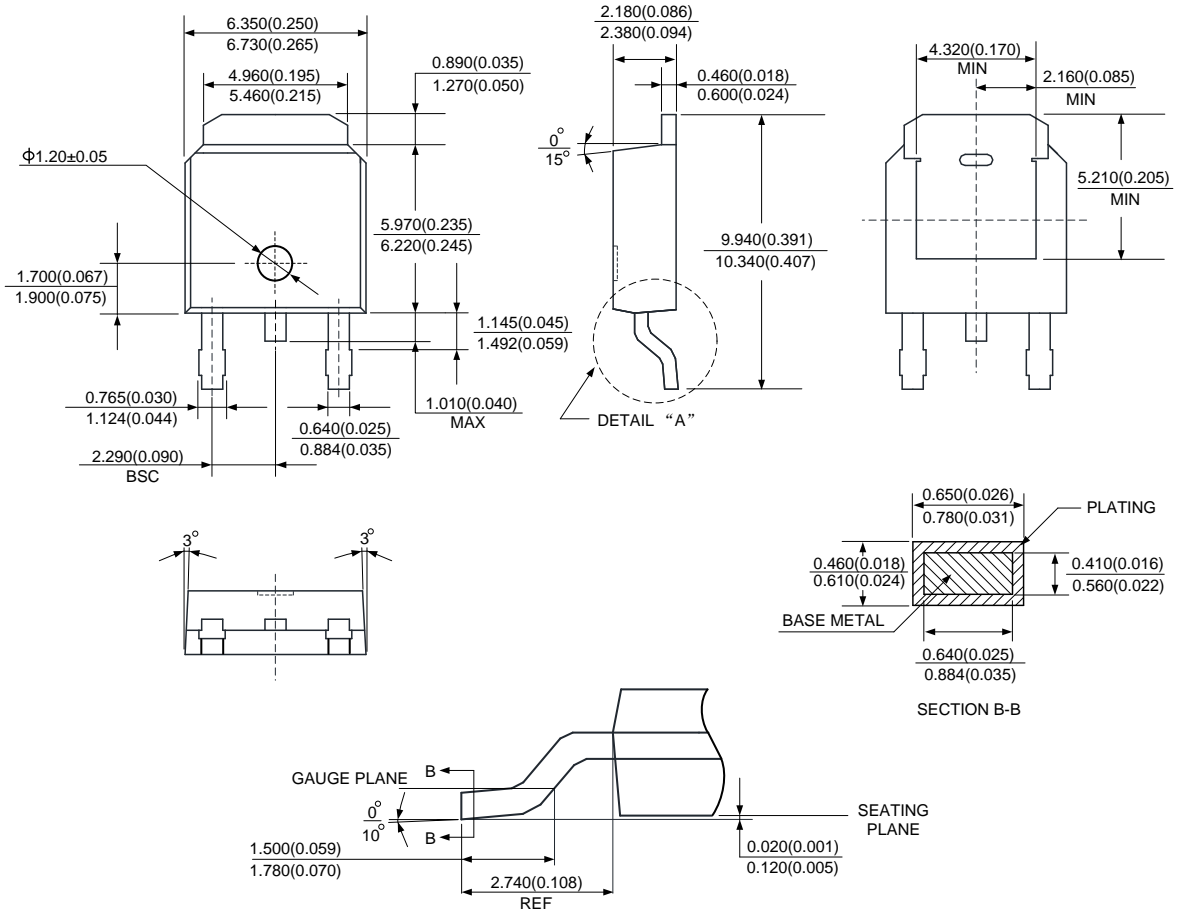

Package Outline Dimensions (All dimensions in mm) (continued)

Please see <http://www.diodes.com/package-outlines.html> for the latest version.

(3) Package Type: TO252-2 (5)

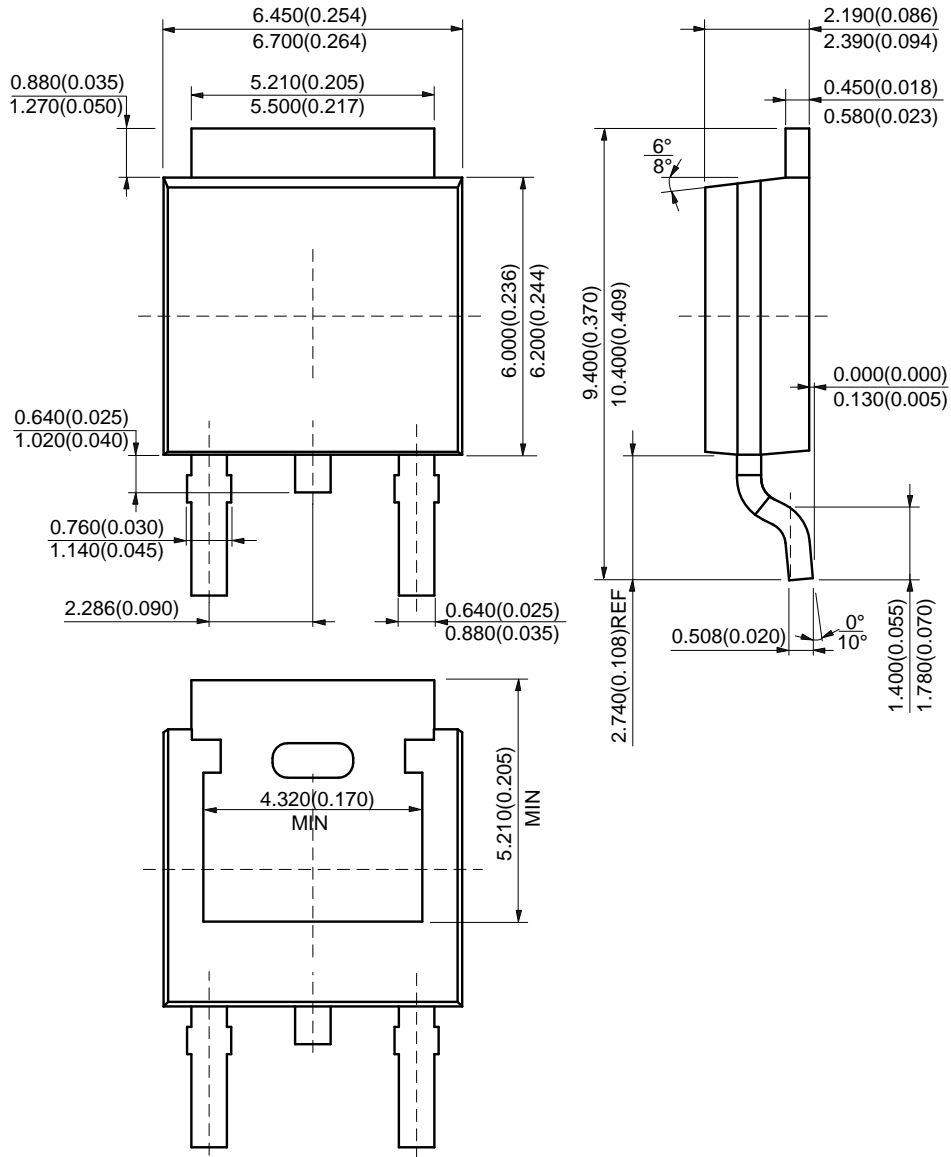

Package Outline Dimensions (continued)

Please see <http://www.diodes.com/package-outlines.html> for the latest version.

(4) Package Type: TO252 (Type CJ)

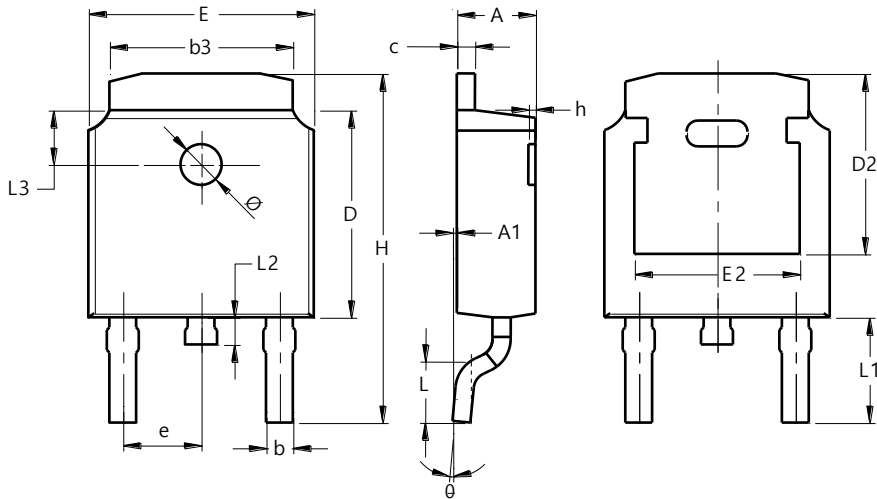

TO252 (Type CJ)			
Dim	Min	Max	Typ
A	2.200	2.400	--
A1	0.000	0.127	--
b	0.635	0.770	--
b3	5.100	5.460	--
c	0.460	0.580	--
D	6.000	6.200	--
D2	5.250 REF		
E	6.500	6.700	--
E2	4.830 REF		
e	2.186	2.386	--
h	0.000	0.300	--
H	9.712	10.312	--
L	1.400	1.700	--
L1	2.900 REF		
L2	0.600	1.000	--
L3	1.600 REF		
Ø	1.100	1.300	--
θ	0°	8°	--
All Dimensions in mm			

Suggested Pad Layout

Please see <http://www.diodes.com/package-outlines.html> for the latest version.

(1) Package Type: TO252-2 (3)

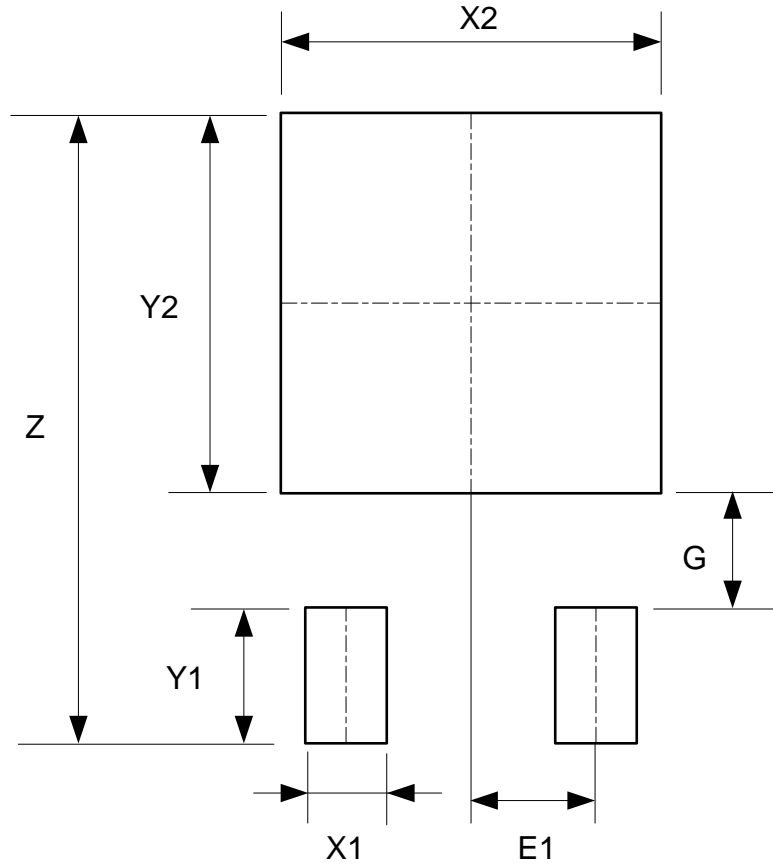

Dimensions	Z (mm)/(inch)	X1 (mm)/(inch)	X2=Y2 (mm)/(inch)	Y1 (mm)/(inch)	G (mm)/(inch)	E1 (mm)/(inch)
Value	11.600/0.457	1.500/0.059	7.000/0.276	2.500/0.098	2.100/0.083	2.300/0.091

Suggested Pad Layout (continued)

Please see <http://www.diodes.com/package-outlines.html> for the latest version.

(2) Package Type: TO252-2 (4)

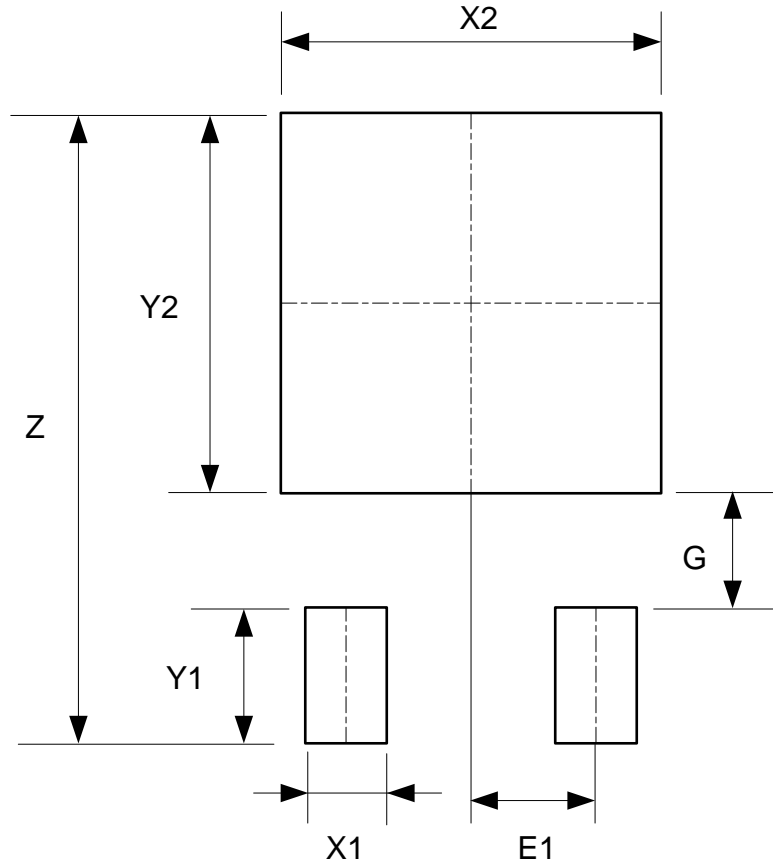

Dimensions	Z (mm)/(inch)	X1 (mm)/(inch)	X2=Y2 (mm)/(inch)	Y1 (mm)/(inch)	G (mm)/(inch)	E1 (mm)/(inch)
Value	11.600/0.457	1.500/0.059	7.000/0.276	2.500/0.098	2.100/0.083	2.300/0.091

Suggested Pad Layout (continued)

Please see <http://www.diodes.com/package-outlines.html> for the latest version.

(3) Package Type: TO252-2 (5)

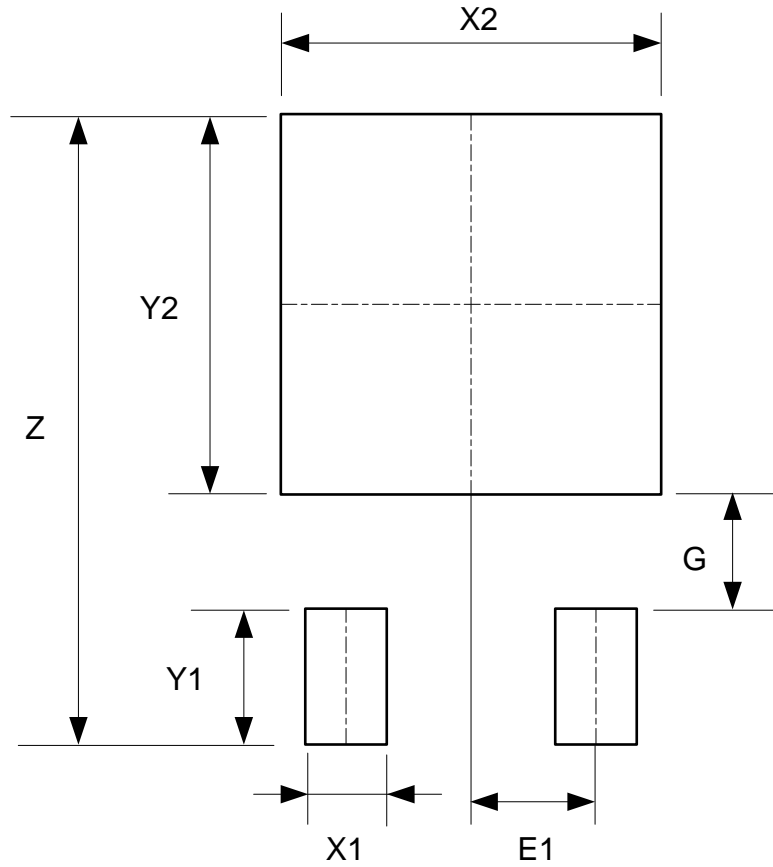

Dimensions	Z (mm)/(inch)	X1 (mm)/(inch)	X2=Y2 (mm)/(inch)	Y1 (mm)/(inch)	G (mm)/(inch)	E1 (mm)/(inch)
Value	11.600/0.457	1.500/0.059	7.000/0.276	2.500/0.098	2.100/0.083	2.300/0.091

Suggested Pad Layout (continued)

Please see <http://www.diodes.com/package-outlines.html> for the latest version.

(4) Package Type: TO252 (Type CJ)

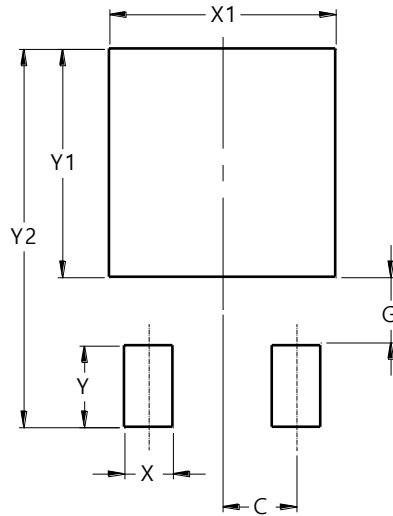

Dimensions	Value (in mm)
C	2.300
G	2.100
X	1.500
X1	7.000
Y	2.500
Y1	7.000
Y2	11.600

Mechanical Data

- Moisture Sensitivity: Level 3 per J-STD-020
- Terminals: Finish—Matte Tin Plated Leads, Solderable per MIL-STD-202, Method 208 e3
- Weight: 0.312 grams (Approximate)

IMPORTANT NOTICE

1. DIODES INCORPORATED (Diodes) AND ITS SUBSIDIARIES MAKE NO WARRANTY OF ANY KIND, EXPRESS OR IMPLIED, WITH REGARDS TO ANY INFORMATION CONTAINED IN THIS DOCUMENT, INCLUDING, BUT NOT LIMITED TO, THE IMPLIED WARRANTIES OF MERCHANTABILITY, FITNESS FOR A PARTICULAR PURPOSE OR NON-INFRINGEMENT OF THIRD PARTY INTELLECTUAL PROPERTY RIGHTS (AND THEIR EQUIVALENTS UNDER THE LAWS OF ANY JURISDICTION).
2. The Information contained herein is for informational purpose only and is provided only to illustrate the operation of Diodes' products described herein and application examples. Diodes does not assume any liability arising out of the application or use of this document or any product described herein. This document is intended for skilled and technically trained engineering customers and users who design with Diodes' products. Diodes' products may be used to facilitate safety-related applications; however, in all instances customers and users are responsible for (a) selecting the appropriate Diodes products for their applications, (b) evaluating the suitability of Diodes' products for their intended applications, (c) ensuring their applications, which incorporate Diodes' products, comply the applicable legal and regulatory requirements as well as safety and functional-safety related standards, and (d) ensuring they design with appropriate safeguards (including testing, validation, quality control techniques, redundancy, malfunction prevention, and appropriate treatment for aging degradation) to minimize the risks associated with their applications.
3. Diodes assumes no liability for any application-related information, support, assistance or feedback that may be provided by Diodes from time to time. Any customer or user of this document or products described herein will assume all risks and liabilities associated with such use, and will hold Diodes and all companies whose products are represented herein or on Diodes' websites, harmless against all damages and liabilities.
4. Products described herein may be covered by one or more United States, international or foreign patents and pending patent applications. Product names and markings noted herein may also be covered by one or more United States, international or foreign trademarks and trademark applications. Diodes does not convey any license under any of its intellectual property rights or the rights of any third parties (including third parties whose products and services may be described in this document or on Diodes' website) under this document.
5. Diodes' products are provided subject to Diodes' Standard Terms and Conditions of Sale (<https://www.diodes.com/about/company/terms-and-conditions/terms-and-conditions-of-sales/>) or other applicable terms. This document does not alter or expand the applicable warranties provided by Diodes. Diodes does not warrant or accept any liability whatsoever in respect of any products purchased through unauthorized sales channel.
6. Diodes' products and technology may not be used for or incorporated into any products or systems whose manufacture, use or sale is prohibited under any applicable laws and regulations. Should customers or users use Diodes' products in contravention of any applicable laws or regulations, or for any unintended or unauthorized application, customers and users will (a) be solely responsible for any damages, losses or penalties arising in connection therewith or as a result thereof, and (b) indemnify and hold Diodes and its representatives and agents harmless against any and all claims, damages, expenses, and attorney fees arising out of, directly or indirectly, any claim relating to any noncompliance with the applicable laws and regulations, as well as any unintended or unauthorized application.
7. While efforts have been made to ensure the information contained in this document is accurate, complete and current, it may contain technical inaccuracies, omissions and typographical errors. Diodes does not warrant that information contained in this document is error-free and Diodes is under no obligation to update or otherwise correct this information. Notwithstanding the foregoing, Diodes reserves the right to make modifications, enhancements, improvements, corrections or other changes without further notice to this document and any product described herein. This document is written in English but may be translated into multiple languages for reference. Only the English version of this document is the final and determinative format released by Diodes.
8. Any unauthorized copying, modification, distribution, transmission, display or other use of this document (or any portion hereof) is prohibited. Diodes assumes no responsibility for any losses incurred by the customers or users or any third parties arising from any such unauthorized use.
9. This Notice may be periodically updated with the most recent version available at <https://www.diodes.com/about/company/terms-and-conditions/important-notice>

The Diodes logo is a registered trademark of Diodes Incorporated in the United States and other countries.
All other trademarks are the property of their respective owners.
© 2024 Diodes Incorporated. All Rights Reserved.

www.diodes.com

Mouser Electronics

Authorized Distributor

Click to View Pricing, Inventory, Delivery & Lifecycle Information:

[Diodes Incorporated:](#)

[AZ1084CS2-3.3TRE1](#) [AZ1084CS-ADJTRG1](#) [AZ1084CS2-ADJTRE1](#) [AZ1084CD-3.3TRG1](#) [AZ1084CS-3.3TRG1](#)
[AZ1084CD-ADJTRG1](#) [AZ1084CS-ADJTRE1](#) [AZ1084CS-3.3TRE1](#) [AZ1084CD-2.5TRG1](#) [AZ1084CS2-3.3TRG1](#)
[AZ1084CS2-2.5TRE1](#) [AZ1084CD-1.8TRG1](#) [AZ1084CD-5.0TRG1](#) [AZ1084CS-2.5TRE1](#) [AZ1084CS-1.8TRE1](#)
[AZ1084CS-5.0TRE1](#) [AZ1084CS-1.5TRE1](#) [AZ1084CS2-1.8TRE1](#) [AZ1084CS2-1.5TRE1](#) [AZ1084CS2-ADJTRG1](#)
[AZ1084CS2-5.0TRE1](#) [AZ1084CD-1.5TRG1](#)