

## A89333 Evaluation Board User Manual

### DESCRIPTION

In all applications where reliability and performance are the main goals, a proper cooling system is needed. The A89333 is a motor controller device suited for different cooling fans. The ability to choose the most suitable MOSFETs makes the A89333 suited for a wide range of applications. With the APEK89333 evaluation board (EVB) and Allegro-provided graphic user interface (GUI), it is possible to test the device in application, determine configuration parameters needed for the application, and program the A89333 with the parameters. The GUI also provides the opportunity to visualize the plots of the main electrical quantities.

This user manual describes how to use the EVB and how to set the algorithms and underlying features that make this device suited for different scenario and suitable for many motors. The step-by-step procedures provided in this manual provide the quickest way to set up the IC and configure its parameters.



Figure 1: APEK89333 Evaluation Board

### EVALUATION BOARD CONTENTS

- APEK89332GEX-01-T-3 evaluation board

Table 1: A89333 Evaluation Kit/Board Configurations

Configuration Name	Part Number
APEK89333GEX-01-T-3	A89333GECSR

### Table of Contents

Description.....	1	Set Motor Electrical Parameters.....	15
Evaluation Board Contents.....	1	Calculation of BEMF Constant ( $K_e$ ).....	15
Overview.....	1	Set Torque Control Mode.....	16
Introduction.....	2	Set PWM and Dead Time.....	16
A89333 Evaluation Board Quick Startup Guide.....	3	Disable Advanced Feature.....	17
Evaluation Setup.....	3	Set Startup Variables.....	18
Make Evaluation Board Connections.....	4	Phase 1: Align or IPD.....	18
Launch A89333 GUI.....	5	Phase 2: Ramp-up.....	22
Read EEPROM and Show Settings.....	6	Phase 3: Drive—Closed-Loop Tuning.....	22
Read Status.....	8	Phase 4: Drive—Speed-Loop Tuning.....	25
(If Required) Load Saved Configuration or Restore EEPROM to Default.....	9	Saving Parameters to EEPROM.....	27
(If Required) Load Configuration from EEPROM into Shadow Registers in RAM.....	10	GUI Tab Explanations and Advanced Features.....	28
(If Required) Verify EEPROM Contents.....	10	Status Tab.....	28
Set Command Duty and Start Motor.....	11	Motor Tab.....	29
Save Configuration to EEPROM or File.....	11	CONFIG2 Tab.....	30
Tips: Load Configuration File and Start Evaluation Without EEPROM Programming and Power Cycling.....	12	Config 3 Tab.....	32
Basic Startup of Motor.....	13	Config 4 Tab.....	35
Set Maximum System Variables.....	13	Startup Tab.....	36
Maximum System Speed.....	13	Brake, Soft-Off Tab.....	37
Maximum System Current and Bus Current Sensing.....	13	Advanced Tab.....	39
DC-Link Voltage.....	14	Speed/UCC Curve.....	40
Maximum Electrical Power.....	14	Faults Tab.....	43
		Schematic.....	44
		Layout.....	45
		Related Links.....	47

## INTRODUCTION

The A89333 is a three-phase sensorless motor controller used for brushless DC (BLDC) motors or permanent-magnet synchronous motors (PMSMs).

The A89333 integrates a code-free sensorless field-oriented control (FOC) algorithm using a single-shunt resistor. The FOC algorithm contains a faster inner current loop to control the current during dynamic load conditions, guaranteeing minimum torque ripple and maximum efficiency. The integrated buck converter allows operation from the maximum  $V_{BB}$  with high efficiency and good thermal performance. The A89333 requires minimal external components, thanks to the single-shunt technique used for current sensing and the advanced algorithm that reconstructs the current on each phase.

Allegro-proprietary algorithms have been used to achieve high efficiency, minimum acoustic noise, fast startup, and high dynamic response in a single easy-to-use device.

The A89333 features multiple options to control the motor—pulse-width modulation (PWM), analog voltage, or inter-inte-

grated circuit (I<sup>2</sup>C)—depending on the application. The variable control loop allows motor control in speed, torque, or power mode with the FOC algorithm maintaining regulation in the presence of load and supply voltage changes. The A89333 integrates advanced diagnostic functions to detect internal and external power-stage and motor faults. Faults are reported through a dedicated fault pin, and the detailed diagnostic status is available through the I<sup>2</sup>C register. An internal nonvolatile memory (NVM) allows configuration of the motor parameters and FOC algorithm based on the specific application.

This guide provides all the steps required to spin a BLDC or PMSM motor using the EVB and the GUI. This guide is divided into three parts:

- A89333 Evaluation Board Quick Startup Guide
- Basic Startup of Motor: Fast procedure to easily spin a motor for basic startup
- GUI Tab Explanations and Advanced Features: Advanced procedure to set all the features of the device

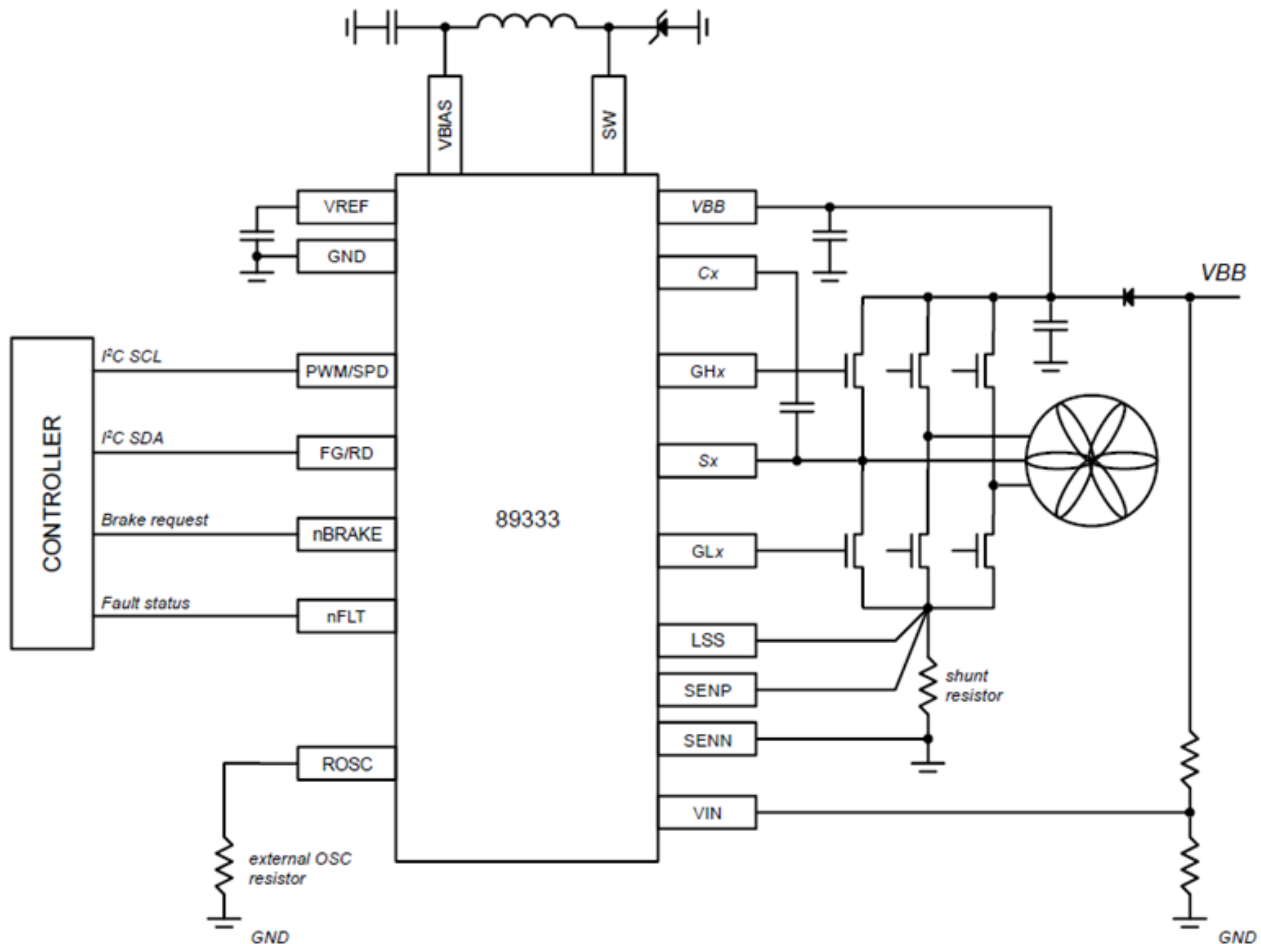

Figure 2: Typical Application Diagram

## A89333 EVALUATION BOARD QUICK STARTUP GUIDE

The APEK89333 evaluation board is designed to aid users in evaluating the operation and performance of the A89333 motor controller IC. It features USB communication to allow GUI software to control and program the device via I<sup>2</sup>C interface and test points to monitor and evaluate performance.

The A89333 evaluation board is connected to a PC with a standard mini-USB cable. A switch (SW2) on the evaluation board is used to select the USB connection directly to A89333 or to an external connector (CN4). The external connector can be used to program A89333 which is already built into a fan module through PWM/SPD and FG/RD pins. See Figure 3.

### Evaluation Setup

The evaluation set up requires:

- A89333 evaluation board (board number: 85-0955)
- A89333 application GUI program (available for download from <http://registration.allegromicro.com/login>)
- PC or laptop computer with USB port capable of running the GUI and controlling the motor
- A BLDC or PMSM motor to be tuned and its electrical parameters
- A DC power supply rated for the application
- Basic laboratory equipment: Oscilloscope with voltage and current probe.

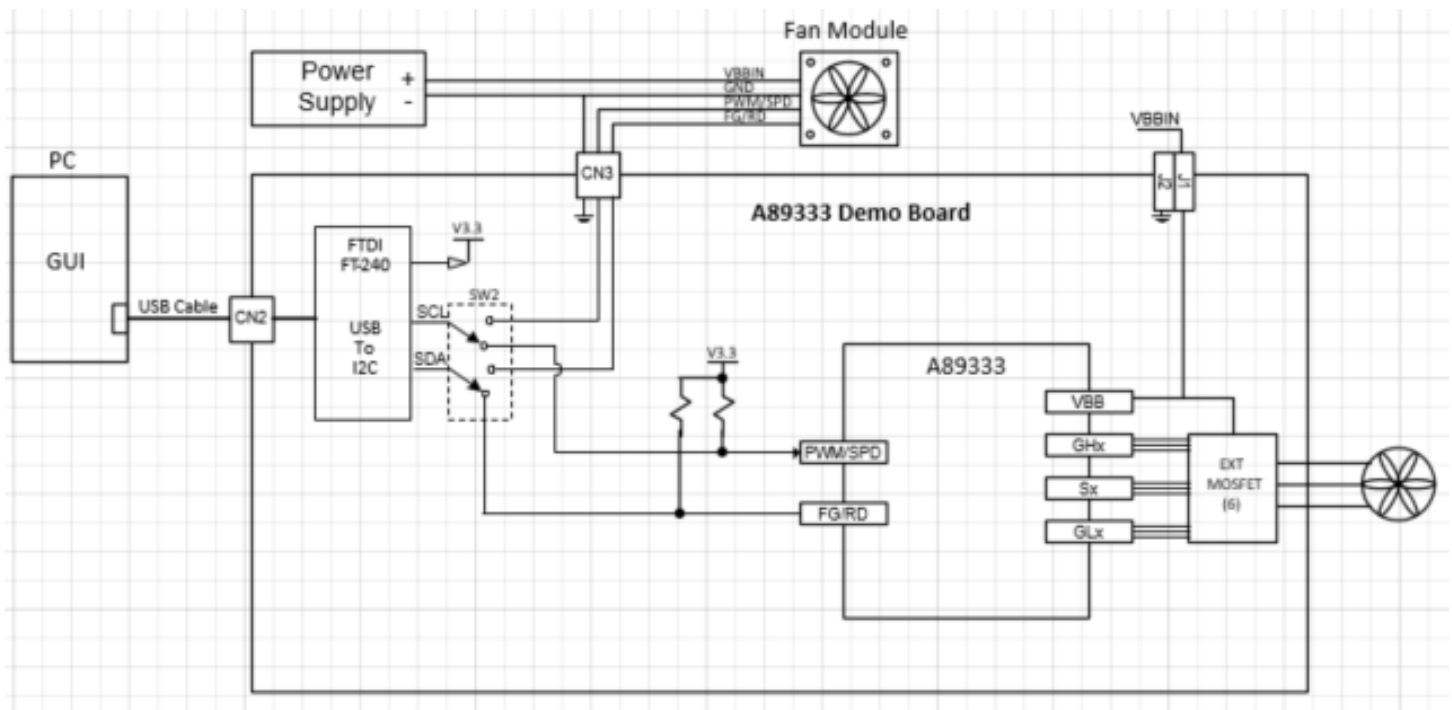

Figure 3: EVB and GUI Interface Setup

## 1. Make Evaluation Board Connections

Make the following connections, as shown in Figure 4:

- A. Mini-USB connection (CN2): Connect the USB cable from the computer.
- B. Power supply input (J1, J2): Connect the power supply to J1 (POS) and J2 (GND).
- C. Motor terminal connection (J3, J4, and J5; or CN3): Connect to the motor terminal.  
  
CAUTION: The default settings in the A89333 may not be appropriate for the motor used, which could cause damage to the IC or motor. Initially, limit the power supply current to 25 – 50% of the rated current of the motor; when the optimal setting is reached, remove the limit.
- D. I<sup>2</sup>C selection (SW2): Toggle the switch to the U1 PROG position to enable the I<sup>2</sup>C interface with the device.

- E. Jumper (JMP2, JMP3):
  - i. JMP2: External PWM/SPD pin pull-up to 3.3 V selection. [1] The default is without the jumper.
  - ii. JMP3: External FG/RD pin pull-up to 3.3 V selection. [1] The default is without the jumper.
- F. Jumper (JMP1): 48 V transient-voltage suppressor (TVS) protection diode selection for application with  $V_{BB}$  less than 48 V. The default is without the jumper.
- G. Jumper (JMP6): nFLT brake function selection. The default is without the jumper, function disabled.
- H. Jumper (JMP4, JMP5):
  - i. JMP4: External nBRAKE pin pull-up to 3.3 V selection. [1] The default is without the jumper.
  - ii. JMP5: nFLT LED selection. The default is without the jumper.
- I. Current sense resistors (R3/R4).
- J. Set the power supply to the appropriate voltage and current, and turn on.

[1] Device internal pull-ups are used.

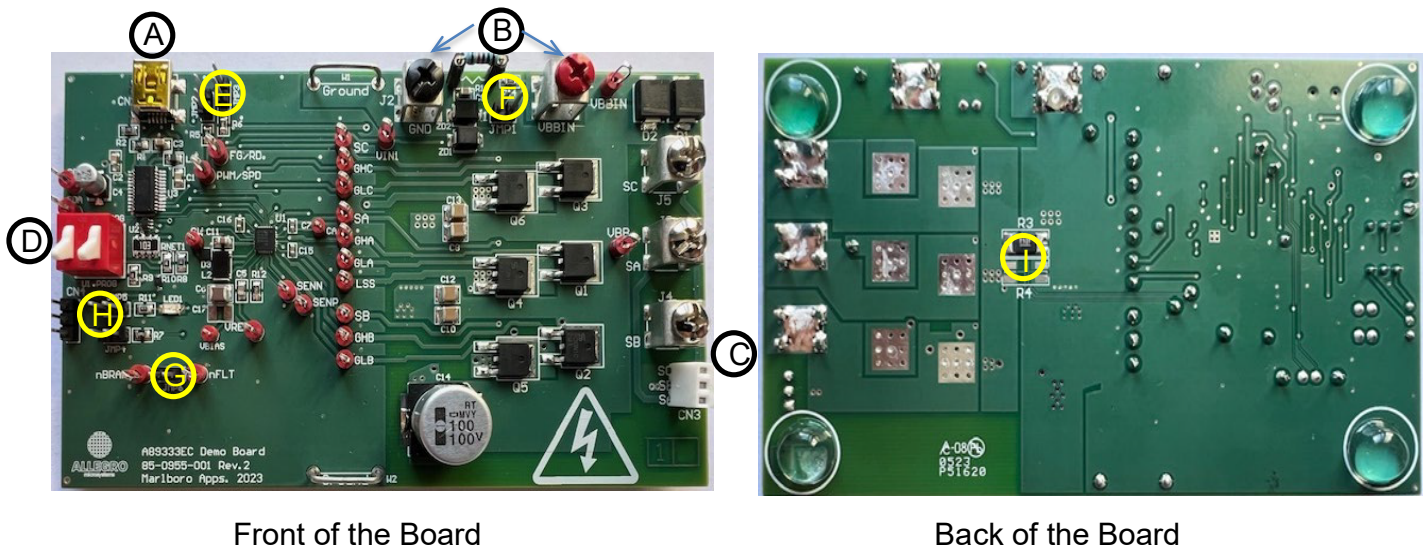

Figure 4: Evaluation Board Connections

## 2. Launch A89333 GUI

The screenshot displays the A89333 BB Application GUI (Version 0.129). The interface includes a menu bar with options like 'Save/Open Configuration', 'Read/Write', and 'Options'. Below the menu, there are buttons for 'Read EEPROM and show settings', 'Write all settings to EEPROM', and 'Toggle Run/Stop'. A speed control section shows '0.00' and 'Set %' buttons. A 'Continuously read status' button is also present.

The main control area features a 'Status' tab and several control panels:

- User Controls:** Includes 'Direction' (radio buttons for ABC and ACB), 'Brake' (radio buttons for Brake and Normal), and 'Unlock the IC' (password field and 'Unlock' button).
- Mode Selection:** Buttons for 'Enter APP mode', 'Enter USER mode', and 'Check IC mode'.
- Status Panel:** Contains a 'Read status' button, a 'Read status continuously with button above' option, and a '# of samples to average' field set to 30.
- Motor Control Mode:** Radio buttons for off, standby, rotate, brake, and fall.
- Motor Control FSM State:** Radio buttons for idle, standby, windmill, brake, and drive.
- IPD Status:** Indicators for OK, STG1 error, STG2 error, and IPD angle.
- Windmill Status:** Indicators for OK, ERR BEMF sequence, ERR BEMF value, and Windmill angle.
- Temperature:** 'Die temperature' indicator.
- Address 0 Status:** Indicators for Over-voltage, Under-voltage, Over-temp, Over-current latch (OCP), EEPROM error, Rotor stalled latch, System OK, Vq limit, Vd limit, Speed limit, Power limit, Voltage (generator) limit, Over-voltage variable limit, and Rotor synced.
- Motor Frequency and Position:** Indicators for Motor frequency, Rotor position, Q voltage, Q current, D voltage, D current, and Q voltage estimate.
- Input/Output:** Indicators for VBB, IBB, Vcmd, Input CMD (ref\_cmd), Input CMD (mca\_extcommand), Processed CMD (mca\_command), Q duty-cycle, D duty-cycle, and Combined Q/D duty-cycle.

A version check window on the right side of the GUI displays the following information:

```

Checking the latest version number at
https://registration.allegromicro.com/...
Latest version = 0.128
This version = 0.129
This version is up to date.
    
```

The bottom right corner of the GUI features the ALLEGRO microsystems logo and the tagline 'INNOVATIONS WITH PURPOSE'.

### 3. Read EEPROM and Show Settings

Click on Read EEPROM and Show Settings. This displays the programmed EEPROM values in the console window to the right. For an unprogrammed device, all zeros are displayed.

The screenshot shows the A89333 BB Application software interface. The 'Read EEPROM and show settings' button is highlighted with a green box. The console window on the right displays the EEPROM read data, also highlighted with a green box. The interface includes various control panels for motor status, temperature, and motor control parameters.

**EEPROM Read Data (from console window):**

```

read EEPROM
Read from 0x04C0 (0x1300) = 0xF8D3876D (417461233)
0x04C1 (0x1304) = 0x28BFF844 (683669572)
0x04C2 (0x1308) = 0x03601D0F (56830543)
0x04C3 (0x130C) = 0xFE4D86E5 (4266493669)
0x04C4 (0x1310) = 0x13FC8C72 (335309938)
0x04C5 (0x1314) = 0x00605558 (6313304)
0x04C6 (0x1318) = 0x02CB0160 (46858592)
0x04C7 (0x131C) = 0x01409C8 (20974024)
0x04C8 (0x1320) = 0x65460800 (1699088384)
0x04C9 (0x1324) = 0x01380FC0 (20451264)
0x04CA (0x1328) = 0xF0005002 (4026552322)
0x04CB (0x132C) = 0x0150003C (22672124)
0x04CC (0x1330) = 0x0A000000 (167772160)
0x04CD (0x1334) = 0x0C0C0000 (202113024)
0x04CE (0x1338) = 0x00002894 (10388)
0x04CF (0x133C) = 0x342F2C48 (875506760)
0x04D0 (0x1340) = 0x00000000 (0)
0x04D1 (0x1344) = 0x00037800 (227328)
0x04D2 (0x1348) = 0x00800000 (8388608)
0x04D3 (0x134C) = 0x00E00000 (14680064)
0x04D4 (0x1350) = 0x020D0000 (34406400)
0x04D5 (0x1354) = 0x5F012332 (1593910066)
0x04D6 (0x1358) = 0x7FFF0000 (2147418112)
0x04D7 (0x135C) = 0x00000000 (0)
0x04D8 (0x1360) = 0x00000000 (0)
0x04D9 (0x1364) = 0x00000000 (0)
0x04DA (0x1368) = 0x00000000 (0)
0x04DB (0x136C) = 0x7FFF0000 (2147418112)
0x04DC (0x1370) = 0x00000000 (0)
0x04DD (0x1374) = 0x00000000 (0)
0x04DE (0x1378) = 0x00000000 (0)
0x04DF (0x137C) = 0x00000000 (0)

disable EEPROM
Read from 0x04E1 (0x1384) = 0x00000000 (0)
Wrote to 0x04E1 (0x1384) : 0x00000004 (4)
Wrote to 0x0041 (0x0104) : 0x0000CADE (51934)
    
```

Some error messages that may occur while using the GUI and the recommended course of action follows.

If this error message occurs:  
Ensure the USB cable is connected.  
If the cable is connected, installation of the FTDI D2XX driver may be required.

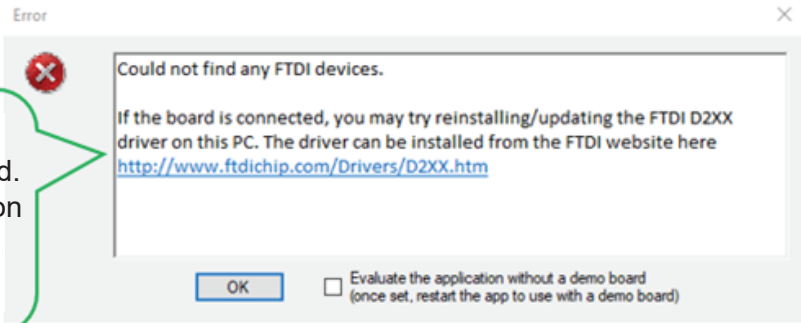

If this error message occurs:  
Ensure the power supply is ON  
and SW2 is set to the U1 PROG  
position.

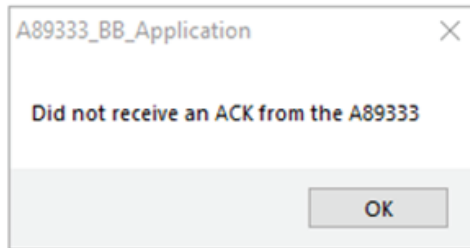

If this error message occurs:  
1. Attempt to communicate with the device a few more times. These additional attempts may be successful because I2C\_SDA is shared with the FG/RD pin, and it could be pulled low by typical FG function.  
2. RD function could be selected, which can also pull the pin low. In this case, reduce VBBB to less than the UVLO level of the device and try again.

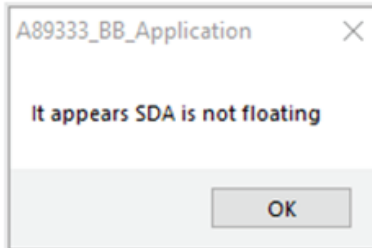

## 4. Read Status

Click on Read Status. A snapshot of the current device status displays. Note the highlighted reading of  $V_{BB}$ . It should match the power supply voltage; this is a good indication that the setup is functioning.

The screenshot shows the Allegro MicroSystems A89333 BB Application software interface. The main window displays various motor control parameters and status indicators. A "Read status" button is highlighted with a green box. The status window shows the following data:

Parameter	Value
Motor control mode	standby
Motor control FSM state	standby
IPD status	OK (finished successfully)
Windmill status	OK (finished successfully)
Temperature	Die temperature = 34.6 °C, 94.2 °F
Motor frequency	0.0 Hz (avg 0.0)
Rotor position	0.0 °
Q voltage	0.0 V (avg 0.00)
Q current	0.000 A (avg 0.000)
D voltage	0.0 V (avg 0.00)
D current	0.000 A (avg 0.000)
Q voltage estimate	0.00 V (avg 0.00)
VBB	48.60 V (avg 48.60)
IBB	0.000 A (avg 0.000)
Vcmd	0.00 V (avg 0.00)
Input CMD (ref_cmd)	0.000 %
Input CMD (mca_extcommand)	0.000 %
Processed CMD (mca_command)	0.000 %
Q duty-cycle	0.0 % (avg 0.00)
D duty-cycle	0.0 % (avg 0.00)
Combined Q/D duty-cycle	0.0 % (avg 0.00)

The  $V_{BB}$  reading is highlighted in yellow, indicating it matches the power supply voltage. The status window also shows a list of memory addresses and their corresponding values, such as 0x04A8 (0x12A0) = 0x00000000 (0).



## 5. (If Required) Load Saved Configuration or Restore EEPROM to Default

If the device already has the desired configuration data programmed in the EEPROM, skip this step.

- A. The A89333 uses a set of configuration data for a particular application. This configuration data can be programmed to EEPROM or saved to a file. If a file for this (or similar) application has been created, open that file as follows:
  - i. Navigate to the Save/Open Configuration tab.
  - ii. Select the open device configuration file.
  - iii. Follow the prompts from the GUI software.

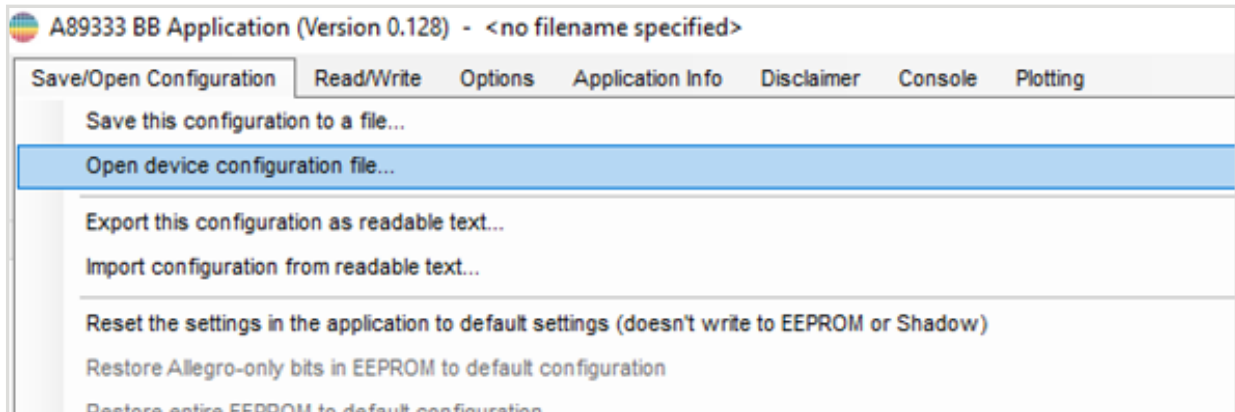

- B. After the file is loaded, click on Write All Settings to EEPROM; this programs the device. EEPROM programming requires  $V_{BB}$  of at least 25 V.

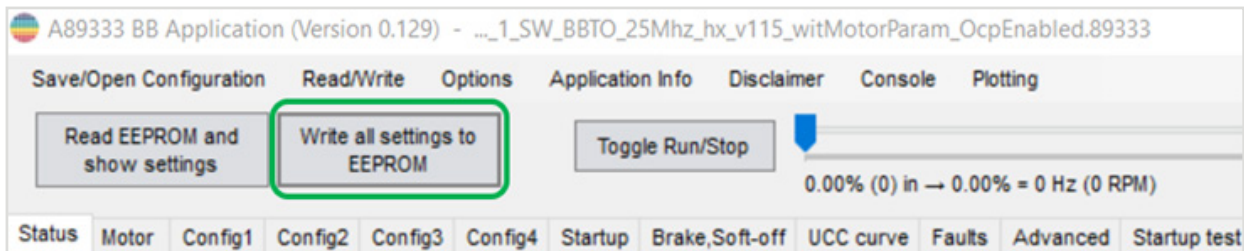

- C. For nonprogrammed devices, the default configurations (12 V default and 48 V default) are provided as a starting point by selecting the appropriate option.

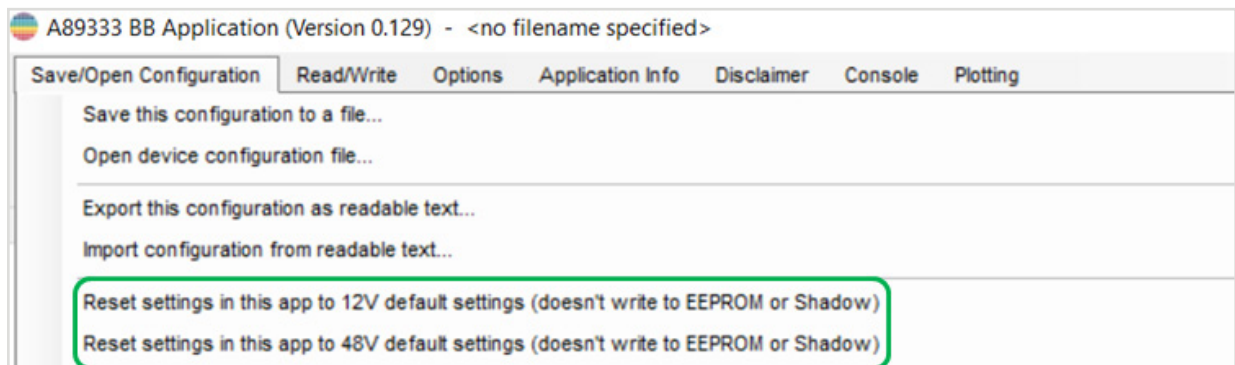

- D. After the file loads, click on Write All Settings to EEPROM; this programs the device.

## 6. (If Required) Load Configuration from EEPROM into Shadow Registers in RAM

If the device already has the desired configuration data programmed in the EEPROM, skip this step.

- A. Cycle the power; this loads the configuration from EEPROM into the shadow registers in RAM. Configuration data needs to be loaded from EEPROM to shadow registers in RAM for A89333 to operate, which happens upon power up.

## 7. (If Required) Verify EEPROM Contents

If the device already has the desired configuration data programmed in the EEPROM, skip this step.

After the power-cycle process completes, click on Read EEPROM and Show Settings (this is the same as step 3) and verify that the EEPROM contents are correct.

The screenshot displays the Allegro A89333 BB Application software interface. The top menu bar includes options like 'Save/Open Configuration', 'Read/Write', 'Options', 'Application Info', 'Disclaimer', 'Console', and 'Plotting'. A toolbar contains buttons for 'Read EEPROM and show settings' (highlighted with a green box), 'Write all settings to EEPROM', 'Toggle Run/Stop', and 'Continuously read status'. The main window is divided into several sections:

- Motor Control:** Includes 'Direction' (ABC/ACB) and 'Brake' (Brake/Normal) settings.
- Status:** A large section with a 'Read status' button and a list of various status indicators such as 'Motor control mode', 'Motor control FSM state', 'IPD status', 'Windmill status', 'Temperature', 'Address 0 status', and 'Motor frequency'.
- read EEPROM:** A window on the right showing a list of memory addresses and their values, with the title 'read EEPROM' highlighted by a green box. The list includes addresses from 0x04C0 to 0x04DF.

The Allegro MicroSystems logo is visible in the bottom right corner of the application window.

## 8. Set Command Duty and Start Motor

To set the command duty and start the motor, follow this iterative process, starting from the default setting and making adjustments to the configuration parameters until a good result is achieved for the application:

- A. Set the command duty using the command slider; begin with a low demand.
- B. Start the motor by clicking Toggle Run/Stop.
- C. Start the evaluation.
- D. To control the motor through the GUI, ensure EXT\_CMD\_SRC is set to I<sup>2</sup>C in the Config1 tab.

NOTE: When adjusting the parameters using the GUI, the motor must be stopped then started for changes to take effect. To run/stop the motor, click Toggle Run/Stop.

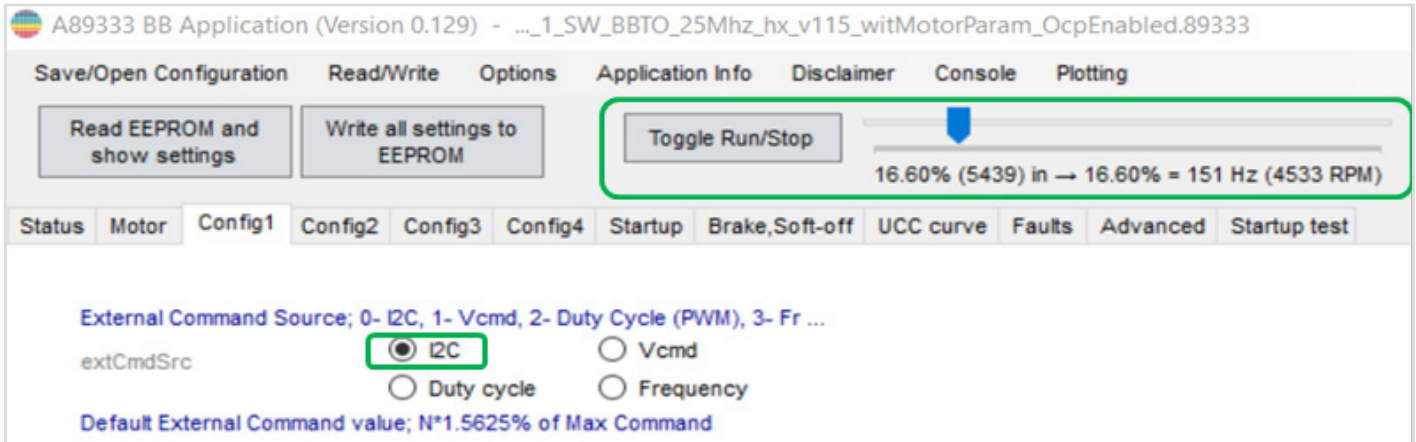

## 9. Save Configuration to EEPROM or File

After a satisfying configuration is achieved, the configuration can be written directly to EEPROM as follows:

- A. Ensure  $V_{BB} \geq 25$  V (this is required to program the EEPROM).
- B. Click Write All Settings to EEPROM or save the configuration to a file using the Save/Open Configuration tab and following the prompts.

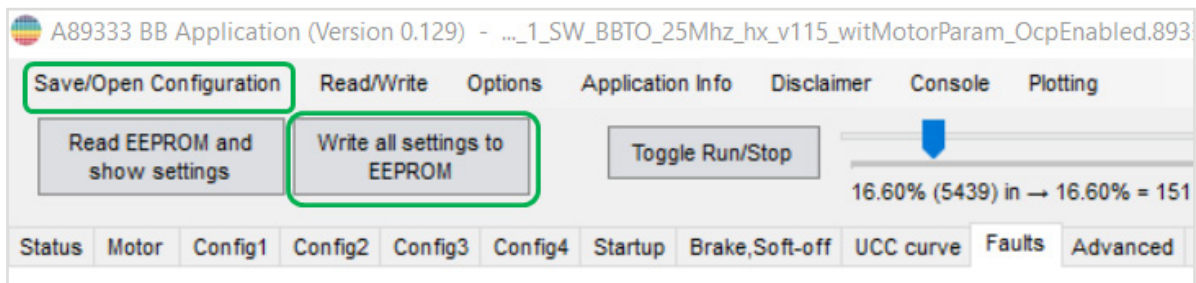

## Tips: Load Configuration File and Start Evaluation Without EEPROM Programming and Power Cycling

After the configuration file is loaded as in step 5, use the Read/Write tab to write the configuration file to shadow registers directly without affecting the existing data in EEPROM. Once the file is written to the shadow registers, the device is ready without the need for power cycling. For the few parameters that are marked in the GUI, changes made to the shadow registers do not take effect until a COMMAND\_OFF and COMMAND\_ON cycle is applied by using the Toggle Run/Stop button.

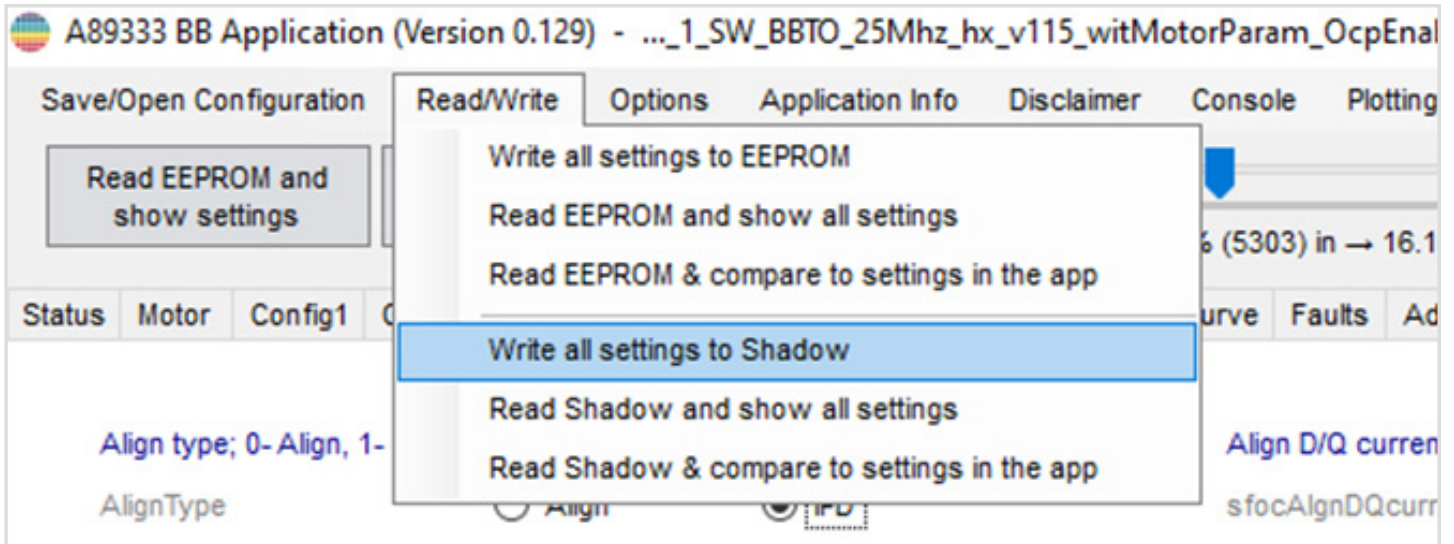

NOTE: Because motor parameters and configurations may be different for different motors, it is advisable to save a specific configuration file for each motor when different motors are used. If the wrong configuration is loaded, it is possible to damage the motor or the evaluation board.

This concludes the EVB quick startup process.

## BASIC STARTUP OF MOTOR

### 1. Set Maximum System Variables

Important application parameters accessed via the Motor Tab of the GUI (as shown in Figure 5) are:

- Single shunt (SENSE\_RESISTOR): Defines the maximum system current and bus current sensing.
- Gain of the CSA (SFOC\_CS\_AGAIN): Defines the maximum system current and bus current sensing.
- DC voltage supply (VBB\_NOM)
- Frequency resolution (SFOC\_FREQ\_RES): Defines the maximum speed of the system.

These parameters are selected as described next.

#### MAXIMUM SYSTEM SPEED

The maximum system speed ( $f_{max}$  [Hz]) is the maximum electrical frequency of the system, and the value is determined by the frequency resolution,  $f_{res}$ , according to:

Equation 1:

$$f_{max} = \text{round}(2^{15} \times f_{res}),$$

where the frequency resolution,  $f_{res}$  [Hz/LSB], is set through the SFOC\_FREQ\_RES register according to:

Equation 2:

$$f_{res} = \frac{1}{9 \cdot 2^{\text{SFOC\_FREQ\_RES}}} \frac{[Hz]}{[LSB]}.$$

SFOC\_FREQ\_RES must be selected so that the resulting maximum system frequency is greater than the rated maximum electrical speed [Hz] of the motor at nominal  $V_{BB}$  supply voltage. For motors with lower speed, it may be preferred to use a lower SFOC\_FREQ\_RES in order to have a higher resolution.

NOTE: Motor speed depends on the supply voltage,  $V_{BB}$ ; therefore, the maximum demand may not result in maximum motor speed if a voltage lower than rated  $V_{BB}$  supply voltage is applied.

#### MAXIMUM SYSTEM CURRENT AND BUS CURRENT SENSING

A89333 uses a single shunt resistor to measure motor phase current involved in the FOC algorithm. The shunt resistor is connected through the SENN and SENP pins. The maximum system current depends on:

- Reference ADC voltage of the ADC ( $ADC_{VREF}$ ), which should equal 1.2 V.
- Gain of the sense amplifier ( $CSA_{GAIN}$ ), which can be set in the SFOC\_CS\_AGAIN parameter in NVM to 10 V/V or 20 V/V.
- Shunt resistance ( $R_{shunt}$ ), which can be set in the SENSE\_RESISTOR parameter in NVM, usually 100 m $\Omega$ .

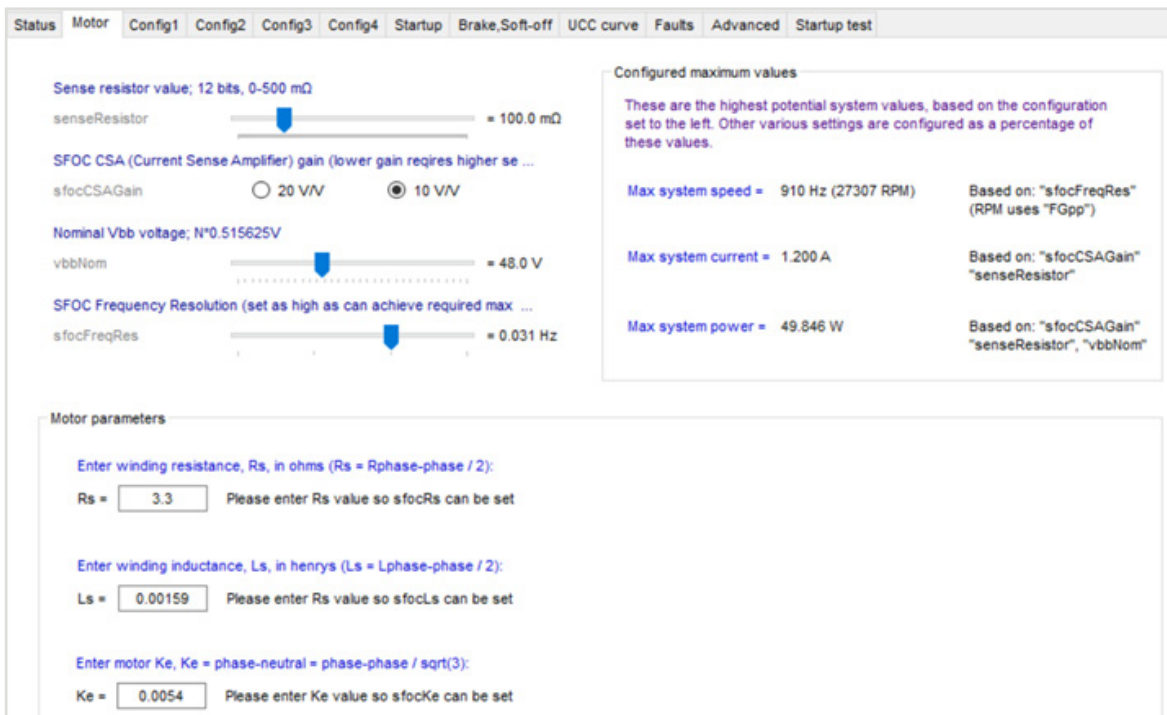

Figure 5: Motor Tab

The maximum current can be expressed as:

Equation 3:

$$I_{max}[A] = \frac{ADC_{VREF}}{R_{shunt} \times CSA_{GAIN}}$$

The maximum system current must be greater than the maximum current rating of the motor. The recommended shunt resistor is one that allows the maximum system current to match the motor used, with 20% margin. Different maximum system current values require different shunt resistors (see Table 2).

**Table 2: Maximum System Current as Function of Shunt Resistance**

Shunt Resistance [mΩ]	Maximum System Current [A]
20	6
50	2.4
100	1.2

NOTE: There are advantages and disadvantages in the selection of CSA gain. With the same current,  $I_{max}$ :

- Low value 10 V/V requires use of an  $R_{shunt}$  that has double the value with respect to 20 V/V  $C_{SA}$  gain; this implies more power dissipation.
- High value 20 V/V causes more noise in the measure.

## DC-LINK VOLTAGE

The nominal DC-link voltage should be set in the VBB\_NOM parameter in NVM.

NOTE: For proper device function, the nominal  $V_{BB}$  used to power the device must be configured correctly in the VBB\_NOM parameter in NVM.

## MAXIMUM ELECTRICAL POWER

The maximum electrical power [W] value is calculated according to:

Equation 4:

$$P_{max}[W] = \frac{3}{2} I_{max} \times 1.1547 \times \frac{V_{BB_{Nom}}}{2}$$

For example, for  $I_{max} = 6.25$  A and  $V_{BB_{nom}} = 12$  V, the maximum electrical power is 64.95 W.

Verify that the desired values of the nominal supply voltage, maximum system current, maximum frequency, and maximum power, match with the configured values reported in the right box of the GUI motor tab as shown in Figure 6.

Proper system operation requires these parameters to be set correctly.

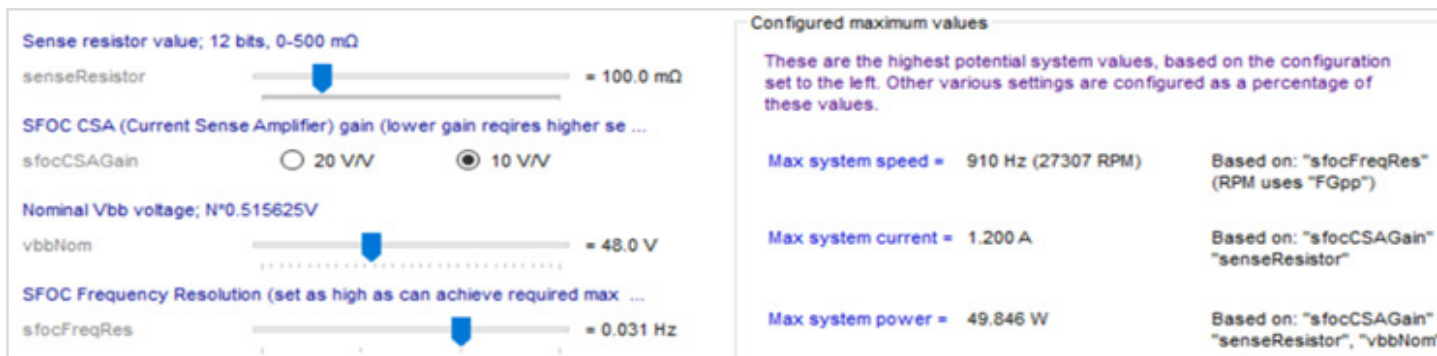

**Figure 6: Motor Tab—Configured Maximum Values**

## 2. Set Motor Electrical Parameters

The Electrical Parameters of the motor must be written in the GUI motor tab (Figure 5); the A89333 algorithms needs the values of:

- Winding stator resistance,  $R_s$  (phase to neutral)
  - $R_s$  phase to neutral =  $R_s$  (line to line)/2 [ $\Omega$ ]
- Winding stator inductance,  $L_s$  (phase to neutral)
  - $L_s$  phase to neutral =  $L_s$  (line to line)/2 [H]
- BEMF constant of the motor,  $K_e$  (phase to neutral)
  - $K_e$  phase to neutral =  $[K_e$  (line to line) / ( $\sqrt{3}$ )] [ $V_{pk} \times \text{sec/rad}$ ]

### CALCULATION OF BEMF CONSTANT ( $K_e$ )

To measure the BEMF of the motor, an external source of torque is often used. For instance, the source of torque can be another motor (M1 on scheme) with its shaft mechanically connected to the test motor (M2 on scheme). This allows spin of the test motor by driving M1. One motor wire of M2 is connected to the voltage probe of the oscilloscope and another wire is connected to the ground end of the probe. An example of the suggested measurement is shown in Figure 7.

Measurement workflow:

- A. Connect the test motor M2 shaft to the drive motor M1.
- B. Connect one phase of M2 to the oscilloscope voltage probe and connect another phase of M2 to the ground of the voltage probe.

- C. Drive motor M1 to rotate at a speed that is approximately 20% to 40% of the rated speed of M2.
- D. When both motors are rotating at steady speed, capture phase voltage data from the oscilloscope (a few periods) and the rotation speed of the test motor.
- E. Stop M1.

The motor electrical constant for both the delta-connected motor and the wye-connected motor can be evaluated using the formula for the motor electrical constant:

Equation 5:

$$k_{e \text{ line to line}} = \frac{U_{peak}}{2\pi f} \left[ \frac{V \cdot s}{rad} \right],$$

where  $U_{peak}$  is the peak voltage amplitude of the M2 phase-to-phase BEMF voltage (any two phases can be used for calculation),  $f = 1/T$  (Hz) is the electrical frequency of BEMF voltage, and  $T[s]$  is the period of BEMF voltage, as shown in Figure 8.

In the formula, the number of pole-pairs is not considered, so the unit of radian stands for electrical rotational frequency, not mechanical frequency.

The measured  $K_e$  is calculated between two phases of the motor, so it is a line-to-line quantity, where the line-to-neutral constant is:

Equation 6:

$$k_{e \text{ line to neutral}} = \frac{k_{e \text{ line to line}}}{\sqrt{3}} \left[ \frac{V \cdot s}{rad} \right]$$

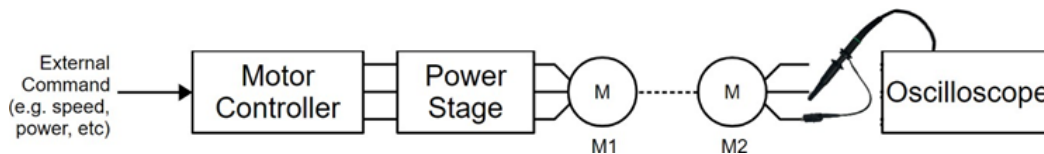

Figure 7: Back EMF Measurement Setup

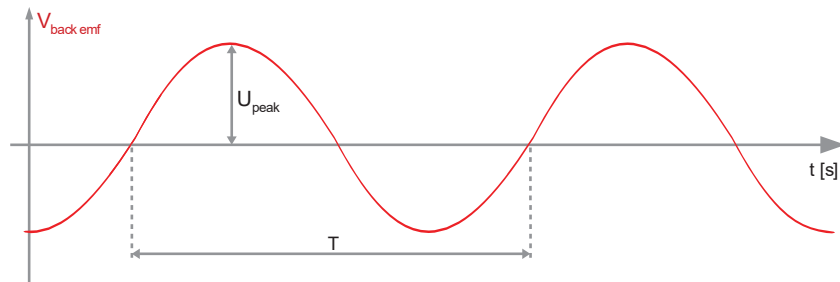

Figure 8: BEMF Phase-to-Phase Voltage

### 3. Set Torque Control Mode

Select the torque control mode—which is among the speed, power, and torque options on the Config1 Tab in the GUI—for the SFOC\_VAR\_CTRL\_MODE parameter in NVM, as shown in Figure 9.

The other speed/power PI controller is not involved in the torque control mode. The rotor position observer, on the other hand, is active and should be appropriately configured with the respective parameters. For the first tuning, set the torque mode to use only the inner current loop control and position observer, avoiding the outer loop that can control the speed or power.

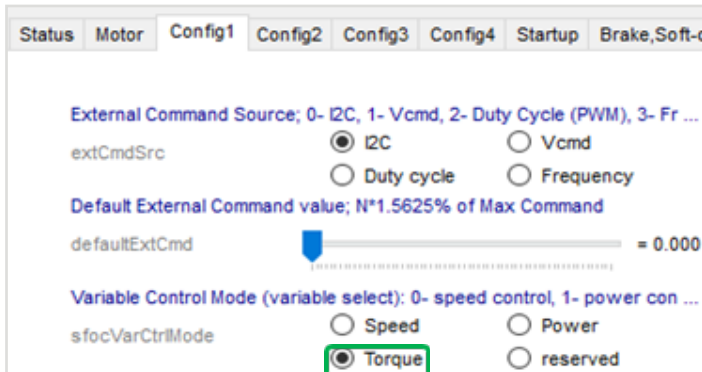

Figure 9: Config1 Tab—Variable Control Mode

### 4. Set PWM and Dead Time

Select the PWM output frequency applied to the motor windings through the PWM\_PERIOD parameter in NVM on the Config1 Tab in GUI. In general, any value around 25 kHz is good. For high-speed applications, there could be a benefit to running at a higher PWM frequency because there are more PWM cycles per electrical period. With more samples per period, the sine wave profile has more resolution, which can result in an improved current waveform. For applications where the motor needs to run at very low speed, the applied duty can be very small, in the 10% range. In this situation, because the calculated duty cycles may approach the dead time of the output stage, there can be a limitation that introduces distortion in the driving waveform. Using a lower PWM frequency improves the distortion at low duty. Decreasing the PWM output frequency may lead to discontinuous phase current for very-low-inductance motors.

To avoid shoot-through current in the MOSFET bridges, dead time is implemented, which delays the high side from turning ON after the low side turns OFF, and delays the low side from turning ON after the high side turns OFF. The desired dead time can be programmed using the PWM\_DEAD\_TIME parameter in NVM.

The dead time depends on the switching characteristics of the selected MOSFET and the available current from the gate drive; therefore, the dead time is affected by the gate-drive slew-current rate. The dead time is set according to the time needed to switch ON or OFF the MOSFET: It must be set sufficiently high that it avoids a short circuit in the single leg of the inverter, yet sufficiently low that it does not increase harmonic distortions.

For the evaluation board and the MOSFET mounted to the board, the recommended dead time is 700 ns. This time is given by:

- Lowest slew current setting.
- MOSFET characteristics.

NOTE: With higher slew rate, the dead time setting can be reduced.



Figure 10: Config 4 Tab—Gate Drive Slew-Rate Settings

#### Turn Off

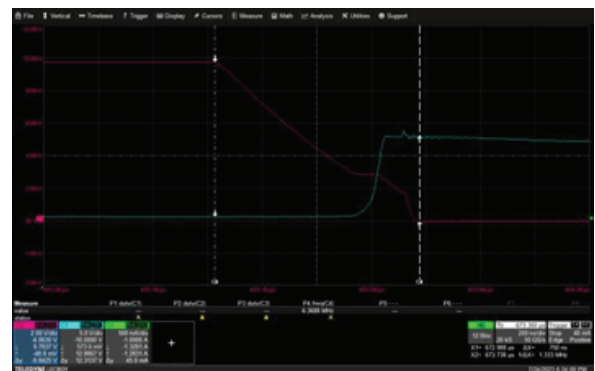

#### Turn On



Figure 11: Turn-Off and Turn-On Behavior—C2 Power MOSFET,  $V_{GS}$ ; C3 Power MOSFET,  $V_{DS}$



## 5. Disable Advanced Feature

For the basic tuning, all the advanced parameter settings must be disabled initially. This includes:

- All the rate-limit variables on the Config2 tab: Select the highest value to avoid the limiting action of these controls, as shown in Figure 12.
- BEMF compensation algorithm: Disabled by setting BEMF\_COMP\_AMPLITUDE = 0 on the Config3 tab.

- Stall detection algorithm: Disabled by setting ROT\_STALL\_DET\_CTRL = 0 on the Faults tab.

NOTE: The focus of this step is to set the base parameters to spin the motor, advanced parameters related to the limiters and the protection could influence the action of the motor controller. For this reason, they are disabled at this time and are detailed in the GUI Tab Explanations and Advanced Features section later in this user manual.

The screenshot displays the Allegro MicroSystems GUI, specifically the Config2 tab. The interface includes a top navigation bar with options like 'Save/Open Configuration', 'Read/Write', 'Options', 'Application Info', 'Disclaimer', 'Console', and 'Plotting'. Below this, there are buttons for 'Read EEPROM and show settings', 'Write all settings to EEPROM', and 'Toggle Run/Stop'. A status bar shows '16.18% (5303) in -- 16.18% = 0.194 A'. The main area is divided into two columns of parameter sliders, each with a numerical value and a unit. The right column also includes a 'Continuously read status' button and a display showing '0.0 Hz (avg 0.0)' and '0.0 RPM (avg 0)'. A console window on the right shows a list of memory addresses and values. The bottom right corner features the Allegro MicroSystems logo and tagline 'INNOVATION WITH PURPOSE'.

Parameter Name	Value	Unit
Current PI Controller proportional gain (signed), 2 <sup>N</sup>	2	
Current PI Controller integral gain (signed), 2 <sup>N</sup>	2048	
Position Observer Theta gain (signed), 2 <sup>N</sup>	256	
Position Observer Frequency gain (signed), 2 <sup>N</sup>	16	
Variable Control (Speed/Power) integral gain (signed), 2 <sup>N</sup>	2	
Variable Control (Speed/Power) proportional gain (signed), 2 <sup>N</sup>	1	
Voltage limit, 100%+N% 78125% of Nominal voltage	57.3	V
Voltage limit threshold (below Voltage limit), (N+1)x0.78125% of Nomina...	53.2	V
Power limit, Nx1.5625% of ((32)x(Max Current) x 1.1547x(Nominal Vol) ...	49.068	W
Speed limit, (N+1)/0.78125% of Max (system) speed	910.2	Hz
	27307	RPM
Speed limit threshold (below Speed limit), (N+1)x0.78125% of Speed li...	903.1	Hz
	27093	RPM
Generator (regenerative brake) Q Current Limit, N%1.5625% of Max cur ...	1.182	A
Current rate limit in Drive mode, [2 <sup>N</sup> (N+1)] x 0.745u% of Max current p...	0.600	A / VCL update
Current rate limit in Generator mode, [2 <sup>N</sup> (N+1)] x 0.745u% of Max curr ...	0.600	A / VCL update
Down current rate limit, [2 <sup>N</sup> (N+1)] x 0.745u% of Max current per VCL ...	0.600	A / VCL update
Reference rate limit, [0.09312u% x 2 <sup>N</sup> ] of Max (system) speed per VC ...	5820.2	Hz / VCL update
Drive Q Current Limit, (N+1)/3.125% of Max current	1.200	A

Figure 12: Config2 Tab—Set Limits and Rates to Maximum

## 6. Set Startup Variables

Startup variables are selected via the Startup tab of the GUI.

With any sensorless motor driver design, a startup process is used to spin the motor from standstill so that BEMF voltage is sufficiently high for the algorithm to detect the rotor position.

The startup has three distinct areas of operation, as shown in Figure 13:

1. Align or initial position detection (IPD)
2. Ramp-up
3. Drive to the target speed or reference variable

The GUI is shown in Figure 14.

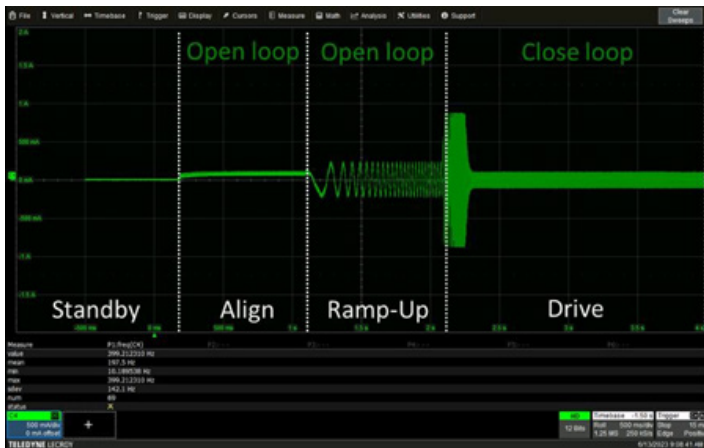

Figure 13: Motor Phase Current During Startup

### PHASE 1: ALIGN OR IPD

The purpose of the align or IPD phase is to move the rotor to a defined location: The rotor is aligned to a known position (align) or the actual position of the rotor is determined (IPD), then the ramp-up acceleration stage begins.

For the align phase, two methods are available:

- DC align: Fixed DC currents (SFOC\_ALIGN\_D\_CURR\_REF) are applied to the motor for a fixed duration (SFOC\_ALIGN\_TIME).
- AC align: AC currents (SFOC\_ALIGN\_D\_CURR\_REF) with frequency equal to  $1/\text{SFOC\_ALIGN\_TIME}$  is used.

NOTE: AC align can be very useful in some cases, such as when a startup failure results from an initial rotor position that is  $180^\circ$  out of phase with the fixed DC alignment.

The most common method to start the motor is the align method. This is because the IPD method does not work for a motor that has zero or very small saliency.

The DC align method can be selected in the GUI as follows:



Figure 14: Startup Tab

DC align is controlled by the current reference (SFOC\_ALGN\_D\_CURR\_REF) and align duration (SFOC\_ALGN\_TIME) parameters.

- Align duration (SFOC\_ALGN\_TIME) holds the position for a programmed duration. This parameter should be set to a value that provides the rotor sufficient time to settle to the align position once the oscillations cease. The duration selected should provide consideration for various stopping locations of the rotor. The worst-case time to settle typically occurs at the point located halfway between two defined motor stopping positions. For initial setup, an align time of approximately 1 s is suggested.
- Current reference (SFOC\_ALGN\_D\_CURR\_REF) sets the applied current during the align phase. This parameter should be set high enough to move the rotor and overcome the inertia and friction. The suggested current setting is approximately 25% of the maximum system current. (Ensure that the maximum system current is set properly for the motor that is used.)

### Tuning Align PI Controllers

In the DC align phase, the PI controller gains are defined by the SFOC\_ALGN\_D\_Q\_CURR\_KP and SFOC\_ALGN\_D\_Q\_CURR\_KI parameters in NVM. These  $K_p$  and  $K_i$  gains apply to the DC align phase only.

AC align is actually part of the ramp-up phase, and the PI controller gains are defined by SFOC\_D\_CURR\_KP and SFOC\_D\_CURR\_KI, and its tuning is detailed in the Current Loop PI Tuning section.

Because torque is linearly proportional to current, in torque mode, the command reference is the current flowing through the motor. Select the current command value using the slider at the top of the GUI (see Figure 15).

To tune the DC align PI controller, the default configuration of the universal curve controller (UCC) is recommended (see Figure 16); for detailed information, refer to the datasheet. With the default UCC, the slider assumes values between 0 and maximum system current.

The recommended reference level is at least equal to 25% of the maximum system current. If the motor struggles to align, increase both the command reference and SFOC\_ALGN\_D\_CURR\_REF

NOTE: Motor startup requires a command reference greater than the threshold of the CMD\_ON\_TH parameter in NVM; similarly, motor turn-off requires a command reference less than the threshold of the CMD\_OFF\_TH parameter in NVM. The difference between the two thresholds defines the hysteresis. Both thresholds are also in the startup tab, as shown in Figure 13. Ensure that both thresholds are set properly.

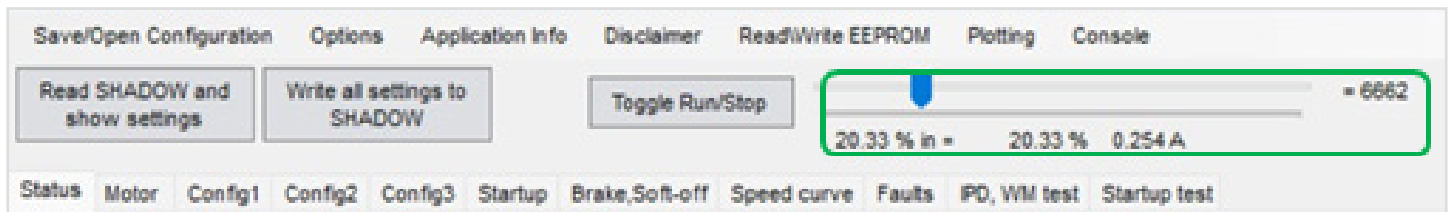

Figure 15: Command Slider in Torque Mode, Showing Current as Reference

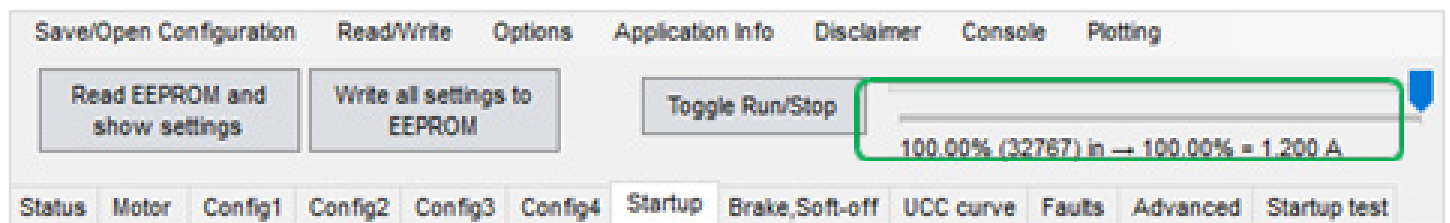

Figure 16: Command Slider, Showing 100% Demand Equal To Maximum System Current

## Align PI Tuning

To tune the align PI controllers:

A. Initiate the align test as follows:

- i. Select the Record/Plot Startup Data on the Plotting tab of the GUI.
- ii. Set the duration of the test to Run/Record of the Test coherent with the choice of the align time.

The duration of the test is set by writing to the Duration to Record field.

iii. Start the test by clicking Test Startup Now.

After clicking the button, the GUI starts and runs the test for the set time, then turns off automatically.

iv. (If desired) To stop the motor, click Command Off.

Stopping the motor is not required.

B. Perform the align PI controller tuning procedure as follows:

- i. Start with configuration  $K_p = 1$  and  $K_i = 1$ .

- ii. Increase  $K_p$  one step at a time, up to the instability. Take the last  $K_p$  before the instability.
- iii. Increase  $K_i$  one step at a time to speed up the action of the controller and reach the current reference of SFOC\_ALIGN\_DCURREF until the instability occurs. Take the last  $K_i$  before the instability.

The results of the tuning process are shown in the figures presented next in the Align PI Tuning Examples that follow:

- When  $K_p$  and  $K_i$  are tuned correctly, the align current of Phase A has no ripple, as shown for  $K_p = 2$ ,  $K_i = 7$  in Figure 19.
- When  $K_p$  is too high, unstable PI controller action is observed in the D current, and oscillations around the current reference are observed on the phase current, as shown for  $K_p = 4$ ,  $K_i = 7$  in Figure 20.
- When  $K_i$  is too high, a ripple is observed in the D current, as shown for  $K_p = 2$ ,  $K_i = 8$  in Figure 21.

NOTE: Tuning results are application-dependent; results will differ from those shown in this user manual.

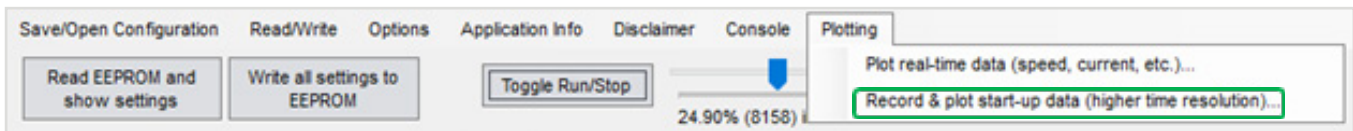

Figure 17: Plotting Tab

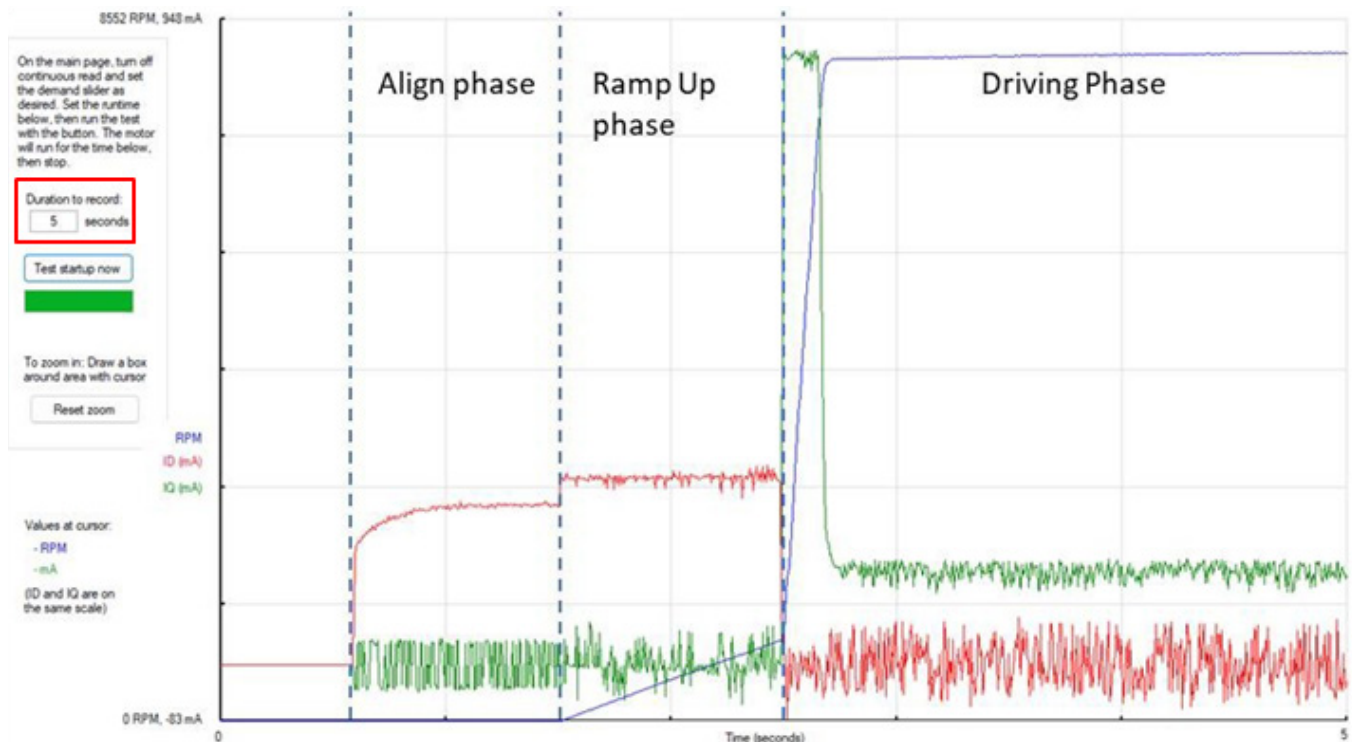

Figure 18: Startup Test Plotting Example

Align PI Tuning Examples

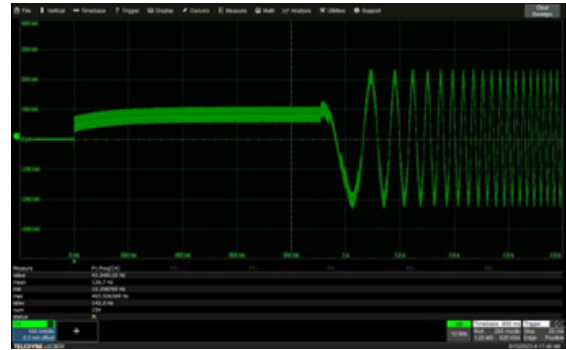
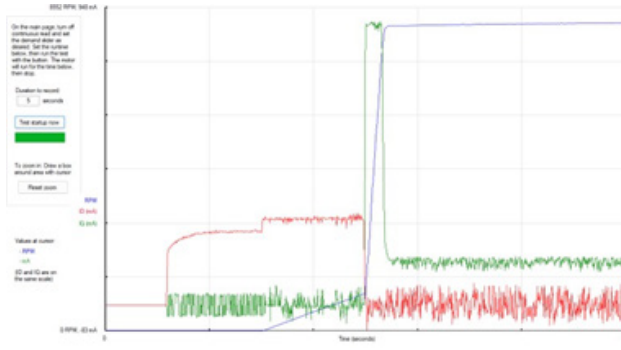

Figure 19: Good Tuning—GUI Plot (left) and Phase Current Plot (right)

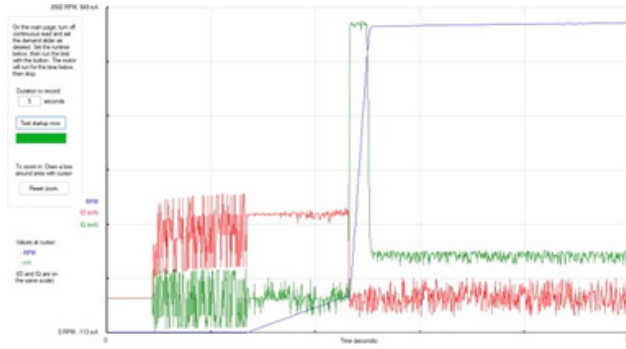

Figure 20:  $K_p$  Instabilities—GUI Plot (left) and Phase Current Plot (right)

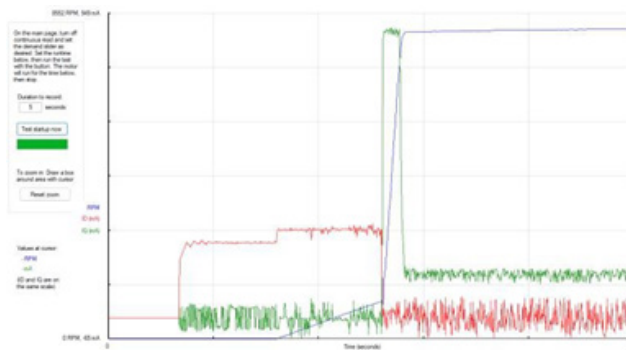

Figure 21:  $K_i$  Instabilities—GUI Plot (left) and Phase Current Plot (right)

## PHASE 2: RAMP-UP

In the ramp-up phase, an open-loop acceleration increases the speed of the motor to an acceptable rate, after which the rotor position can be reliably measured from the positioning observer; the rotor frequency is increased until it reaches the open-loop to closed-loop (OL-CL) transition frequency, end freq.

To accelerate the motor, the driving current reference of the motor must be defined in the SFOC\_RUP\_D\_CURR\_REF parameter in NVM. This reference must be sufficient to generate enough torque to spin the rotor up to the desired end frequency indicated on the startup tab of the GUI, as shown in Figure 22.

During the ramp-up phase, the acceleration rate is defined by the SFOC\_RAMP\_STEP value, and the total time of acceleration is equal to the SFOC\_RAMP\_TIME. The SFOC\_RAMP\_STEP and SFOC\_RAMP\_TIME together define the end frequency. Ramp-up speed is not affected by the value of the current.

The inertia of the load is used to set the SFOC\_RAMP\_STEP and SFOC\_RAMP\_TIME: Due to the current demand, the higher the inertia, the lower the SFOC\_RAMP\_STEP.

The end frequency is where the transition from open-loop to closed-loop operation occurs. The set value must be high enough to produce reliable estimates of the rotor position from the observer. A general rule is to set the end frequency to approximately 5–10% of the rated speed.

Generally, a fast startup demands higher current.

## PHASE 3: DRIVE—CLOSED-LOOP TUNING

In this phase, the inner current PI controller and the position observer controllers are tuned to spin the motor.

The tuning procedure has two parts:

1. Current controller tuning using SFOC\_D\_CURR\_KP then SFOC\_D\_CURR\_KI; the procedure is the same for the align PI controller.
2. Positioning observer tuning using SFOC\_PO\_THETA\_K and SFOC\_PO\_FREQ\_K.

These parameters are on the Config2 tab, shown in Figure 23.

Whenever monitoring of currents, voltages, and frequency is possible, the Record/Plot Startup Data button is available on the plotting tab of the GUI.

NOTE: That motor phase current during the driving phase is limited by SFOC\_DRV\_CURR\_DRV\_LMT.

Because torque mode is still in use in this phase, the command reference is still current. Similarly, select the command reference with the slider at the top of the GUI, as shown in Figure 15.

Just like the align PI Controller Tuning, it is advisable to leave the Universal Curve Controller in the default configuration. With the default UCC, the slider assumes values between 0 and maximum system current.

To start the tuning procedure, select a current reference. The recommended current reference is in the order of 20 – 30% of the maximum system current.

During tuning, the motor must not rotate at the maximum rated speed. This is important because, at maximum speed, the BEMF generated is almost equal to the supply voltage, so a further current increase is not possible. If the motor were to rotate at the maximum rated speed, the motor would be limited by the supply voltage and might not reach the desired current set point. To avoid the problem, select a lower current reference command.



Figure 22: OL-CL Transition Frequency (End Freq)



Figure 23: Closed-Loop Current PI and Observer Parameters

### Current Loop PI Tuning

Select the Record/Plot Startup Data on the Plotting window of the GUI:

1. Set the starting configuration to  $K_p = 1$  and  $K_i = 8$ .
2. Increase  $K_p$  one step at a time, until instability occurs, then select the last value before the instability occurred.
3. Increase  $K_i$  one step at a time to increase the speed of the controller and reach the slider-defined current reference until the instability occurs, then use the last value before the instability occurred.

The procedures and results for the PI tuning for the current control loop follow.

### CCL PI Tuning, Step-by-Step Procedure

1. Initial settings and behavior are as shown:

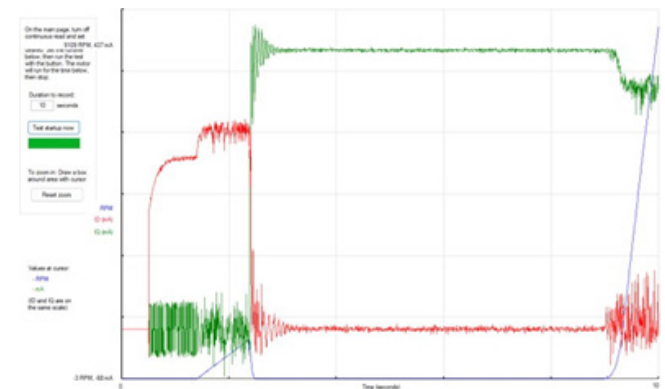

SFOC\_D\_CURR\_KP = 1, SFOC\_D\_CURR\_KI = 8  
SFOC\_PO\_THETA\_K = 9, SFOC\_PO\_FREQ\_K = 4

For these settings, the plot shows that the motor reaches the end of the ramp up, but the gains of the current controller are too low, and the motor position observer is not able to synchronize. For this reason, SFOC\_D\_CURR\_KP must be increased.

2. SFOC\_D\_Q\_CURR\_KP is increased to 2, resulting in the behavior shown:

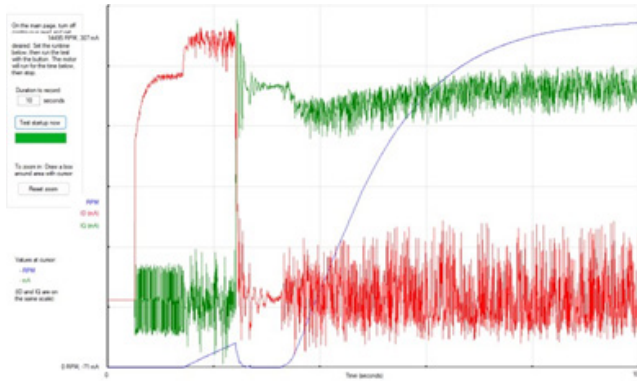

**SFOC\_D\_CURR\_KP = 2, SFOC\_D\_CURR\_KI = 8  
SFOC\_PO\_THETA\_K = 9, SFOC\_PO\_FREQ\_K = 4**

This setting is still too low, and the motor position observer is not able to synchronize. The SFOC\_D\_Q\_CURR\_KP parameter must be increased further.

3. SFOC\_D\_Q\_CURR\_KP is increased again and instability is not observed:

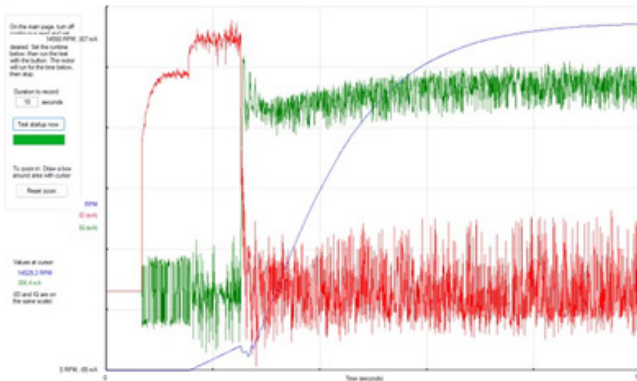

**SFOC\_D\_CURR\_KP = 3, SFOC\_D\_CURR\_KI = 8  
SFOC\_PO\_THETA\_K = 9, SFOC\_PO\_FREQ\_K = 4**

4. SFOC\_D\_Q\_CURR\_KP is increased again and instability is not observed:

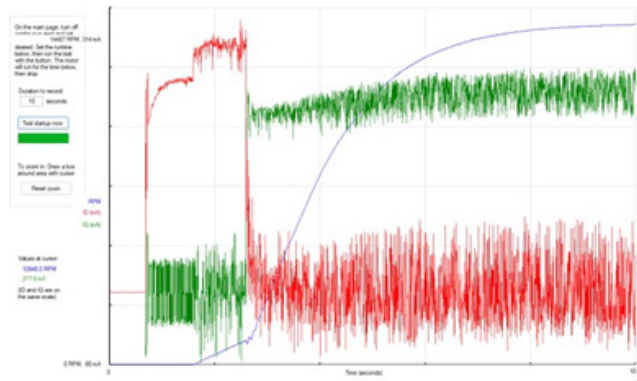

**SFOC\_D\_CURR\_KP = 4, SFOC\_D\_CURR\_KI = 8  
SFOC\_PO\_THETA\_K = 9, SFOC\_PO\_FREQ\_K = 4**

5. SFOC\_D\_Q\_CURR\_KP is increased again and instability is observed:

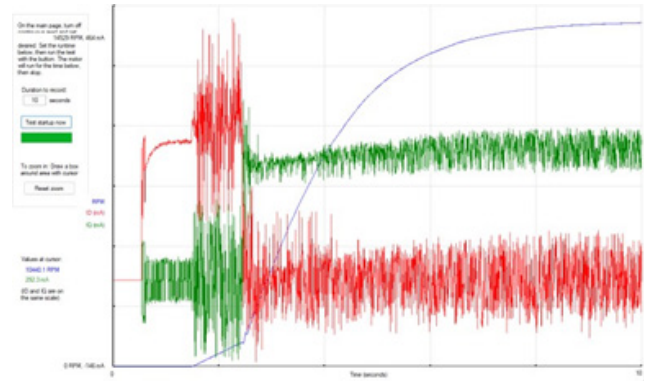

**SFOC\_D\_CURR\_KP = 5, SFOC\_D\_CURR\_KI = 8  
SFOC\_PO\_THETA\_K = 9, SFOC\_PO\_FREQ\_K = 4**

6. Configure the device to the value used before the instability was observed. The results shown in both steps 3 and 4 are good options, showing the correct tuning is achieved with  $K_p = 3$  or  $K_p = 4$ .

7. Tune  $K_i$  and increase  $K_i$  by one click. As shown in the third plot that follows, with  $K_p = 4$  and  $K_i = 64$ , a good result is achieved.

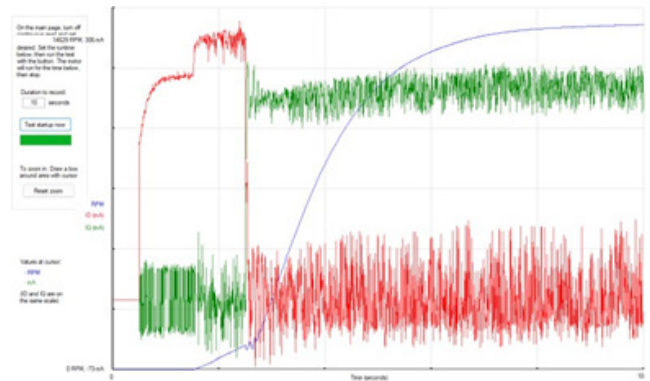

**SFOC\_D\_CURR\_KP = 4, SFOC\_D\_CURR\_KI = 16  
SFOC\_PO\_THETA\_K = 9, SFOC\_PO\_FREQ\_K = 4**

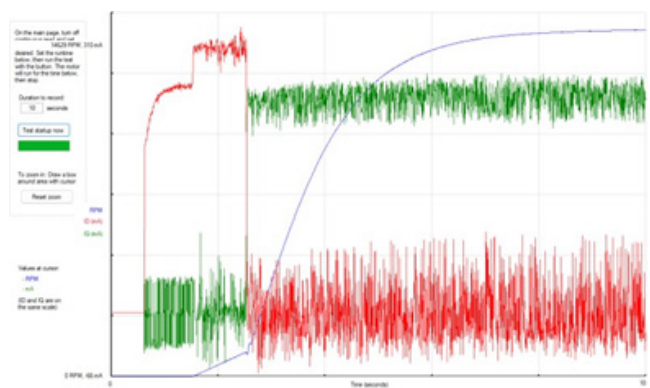

**SFOC\_D\_CURR\_KP = 4, SFOC\_D\_CURR\_KI = 32  
SFOC\_PO\_THETA\_K = 9, SFOC\_PO\_FREQ\_K = 4**



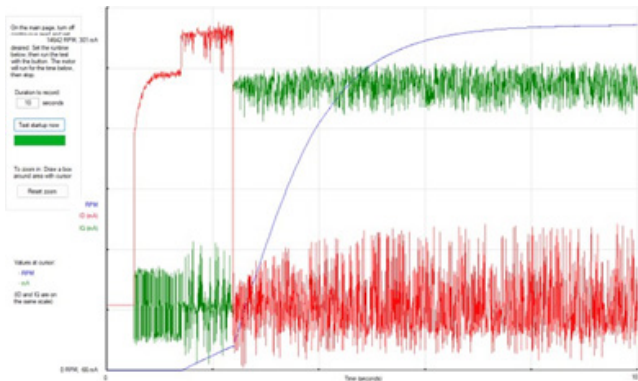

SFOC\_D\_CURR\_KP = 4, SFOC\_D\_CURR\_KI = 64  
 SFOC\_PO\_THETA\_K = 9, SFOC\_PO\_FREQ\_K = 4

These settings are used next, for the starting inputs in the Position Observer (PO) Tuning section:

### Position Observer (PO) Tuning

Using the Record/plot startup data feature in the Plotting window on the GUI:

1. Start with configuration that obtained good results in the CCL PI Tuning, Step-by-Step Procedure section: In this example, SFOC\_PO\_THETA\_K = 9 and SFOC\_PO\_FREQ\_K = 4.
2. Increase both parameters in unison, one step at a time, until the instability occurs. Use the values that were input before the instability occurred.
3. To improve control at high frequencies, maintain the observer parameters that guarantee the fastest dynamics.

The PO tuning results follow. In this case, the step needed is lower than the previous examples due to the high initial gain setting. As shown, the best configuration for the position observer is achieved with SFOC\_PO\_THETA\_K = 10 and SFOC\_PO\_FREQ\_K = 5.

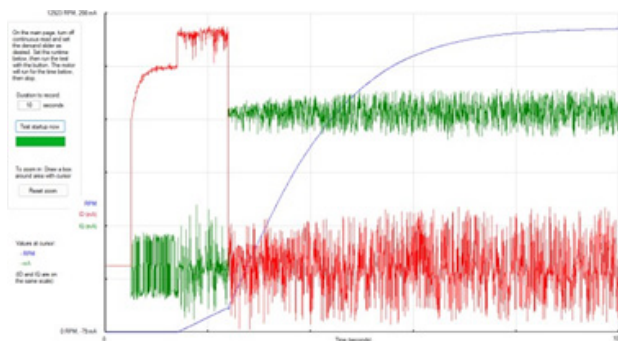

SFOC\_D\_CURR\_KP = 4, SFOC\_D\_CURR\_KI = 64  
 SFOC\_PO\_THETA\_K = 9, SFOC\_PO\_FREQ\_K = 4

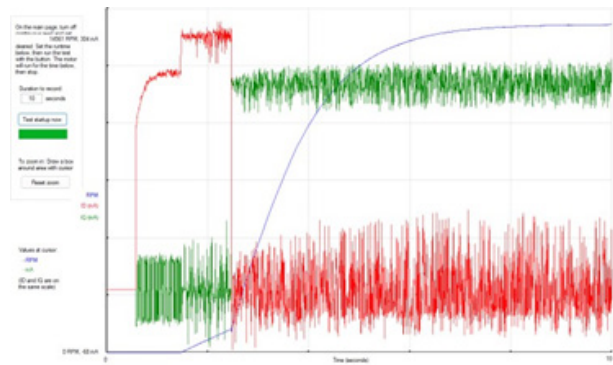

SFOC\_D\_CURR\_KP = 4, SFOC\_D\_CURR\_KI = 64  
 SFOC\_PO\_THETA\_K = 10, SFOC\_PO\_FREQ\_K = 5

### PHASE 4: DRIVE—SPEED-LOOP TUNING

The current PI and the position observer have been tuned, now it is time to tune the speed-loop PI parameters SFOC\_VAR\_KP and SFOC\_VAR\_KI, located on the Config2 tab. To enter speed mode, select it with SFOC\_VAR\_CTRL\_MODE parameter in NVM in Config1 Tab in GUI. The control variable is the speed, the action of the PI is completely different from CCL, now the UCC goes from 0 to the maximum speed, the reference is the speed of the motor.

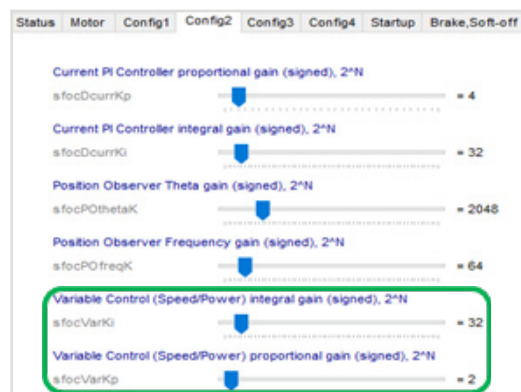
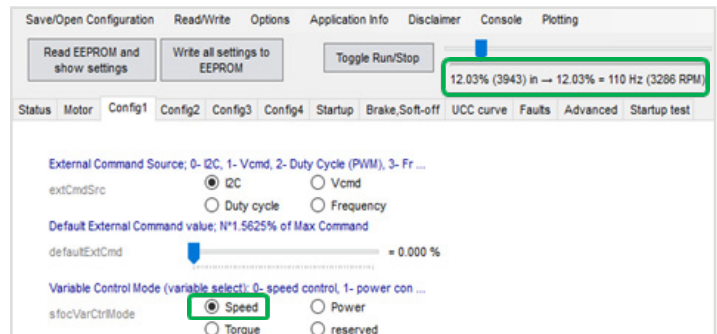

Figure 24: Config1 Tab—Speed Control Selection

## Speed-Loop PI Tuning

Select the Record/Plot Startup Data menu on the Plotting window of the GUI:

1. Start with configuration  $K_p = 1$  and  $K_i = 1$ .
2. Increase  $K_p$  one step a time up to the instability and take the last value before instability.
3. Increase  $K_i$  one step at a time to speed up the action of the controller and reach the speed reference defined with the slider until the instability occurs and use the last value before instability

To start the tuning procedure, it is good to select a speed reference that is approximately 20% to 30% of the maximum system speed.

Step-by-step tuning procedures for  $K_p$  and  $K_i$  follow.

### Speed-Loop $K_p$ Tuning, Step by Step

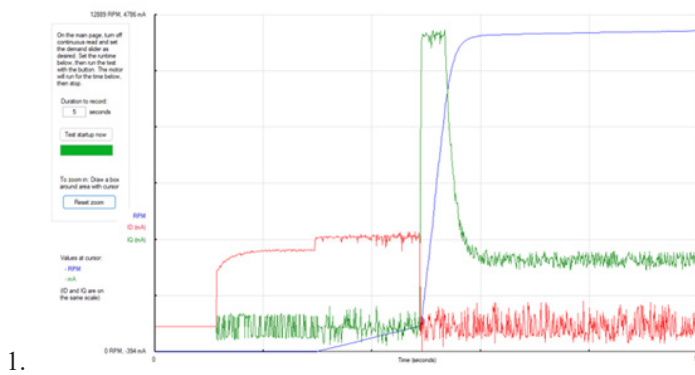

**SFOC\_VAR\_KP = 1, SFOC\_VAR\_KI = 1**

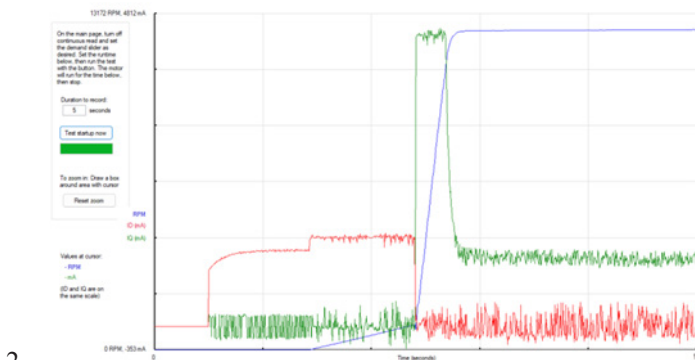

**SFOC\_VAR\_KP = 2, SFOC\_VAR\_KI = 1**

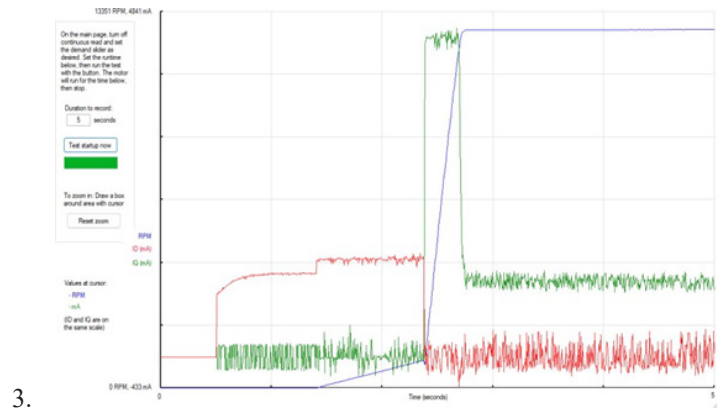

**SFOC\_VAR\_KP = 4, SFOC\_VAR\_KI = 1**

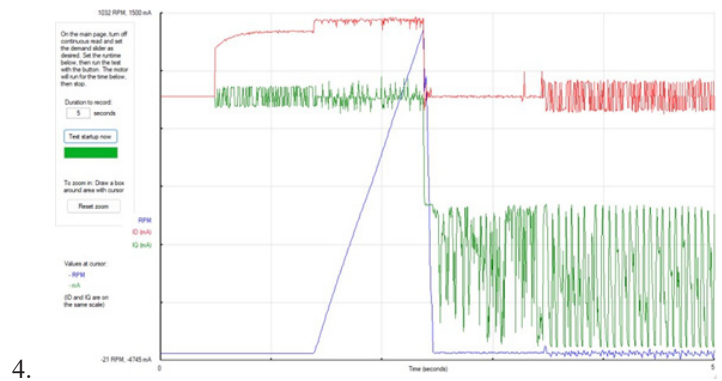

**SFOC\_VAR\_KP = 8, SFOC\_VAR\_KI = 1**

At  $K_p = 8$ , the system becomes unstable, so the process is stopped and the previous setting,  $K_p = 4$ , is used next in the Speed-Loop  $K_i$  Tuning, Step by Step procedure.

## Speed-Loop $K_i$ Tuning, Step by Step

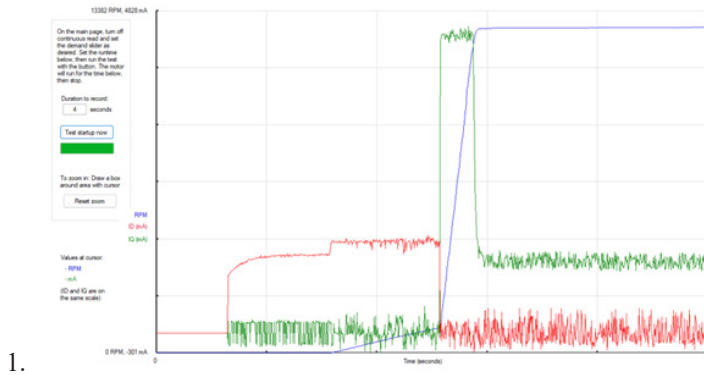

1. SFOC\_VAR\_KP = 4, SFOC\_VAR\_KI = 2

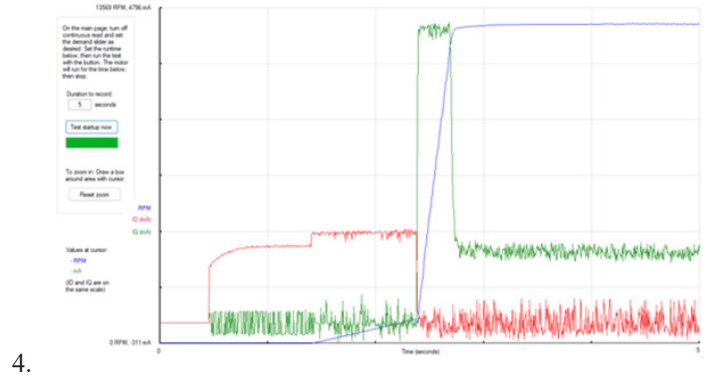

4. SFOC\_VAR\_KP = 4, SFOC\_VAR\_KI = 32

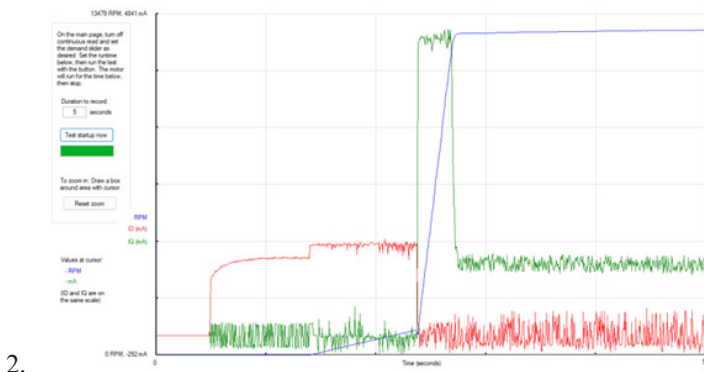

2. SFOC\_VAR\_KP = 4, SFOC\_VAR\_KI = 4

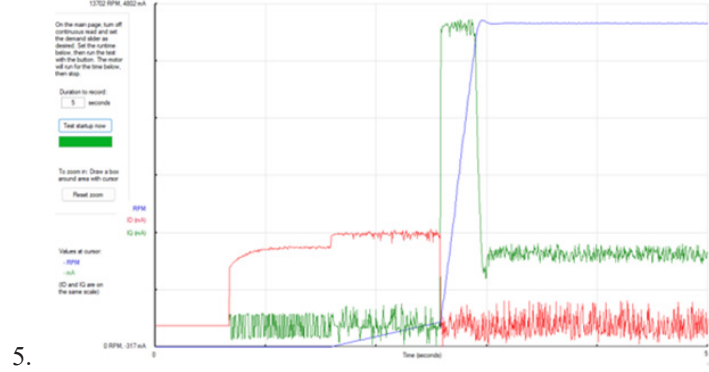

5. SFOC\_VAR\_KP = 4, SFOC\_VAR\_KI = 64

Overshoot begins to be observed, so the previous setting,  $K_i = 32$ , is used.

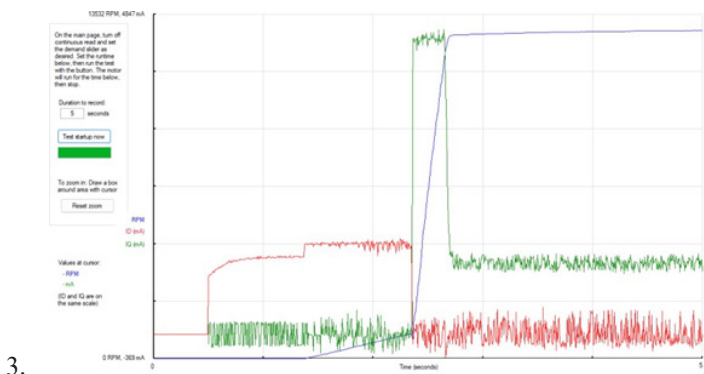

3. SFOC\_VAR\_KP = 4, SFOC\_VAR\_KI = 8

### SAVING PARAMETERS TO EEPROM

As explained in the preceding sections, all the settings adjusted using the GUI are written to the shadow registers. Parameters set via the shadow registers are stored in RAM, so they persist as long as the A89333 is powered ON.

To use the same parameters after a power cycle of the part, the parameters must be saved to the EEPROM of the A89333.

To save parameters to EEPROM:

1. On the top of the GUI, click Write All Setting to EEPROM.

For more details, refer to the A89333 Evaluation Board Quick Startup Guide section, Step 9: Save Configuration to EEPROM or File.

This concludes the Basic Startup of Motor section.

## GUI TAB EXPLANATIONS AND ADVANCED FEATURES

After the motor has been driven successfully following the basic startup procedure, set the advanced parameters. Each tab contains a description of each parameter. For more-detailed descriptions of parameters and their controls, refer to the datasheet.

### Status Tab

The user controls section of the status tab is used to make the following selections:

- Command the direction of the motor
- Force the brake state (not forced is the typical operation setting) using the BRAKE\_CTRL register. When the brake is selected, the A89333 remains in the brake state.

The status section of the status tab is used to monitor the following variables and modes of operation:

- Motor control mode
- Motor control FSM state
- IPD status
- Windmill status
- Fault flags
- FOC algorithm variables

The status tab is particularly useful for troubleshooting: By setting the Continuously Read Status menu, variables and states can be displayed in real time. The current running states of the machine are displayed in blue font, while the faults in address 0 are displayed in red font when a corresponding fault occurs. Variables related to FOC and demand control are displayed in the status pane at right. User password unlock and IC mode control are also provided on the status tab.

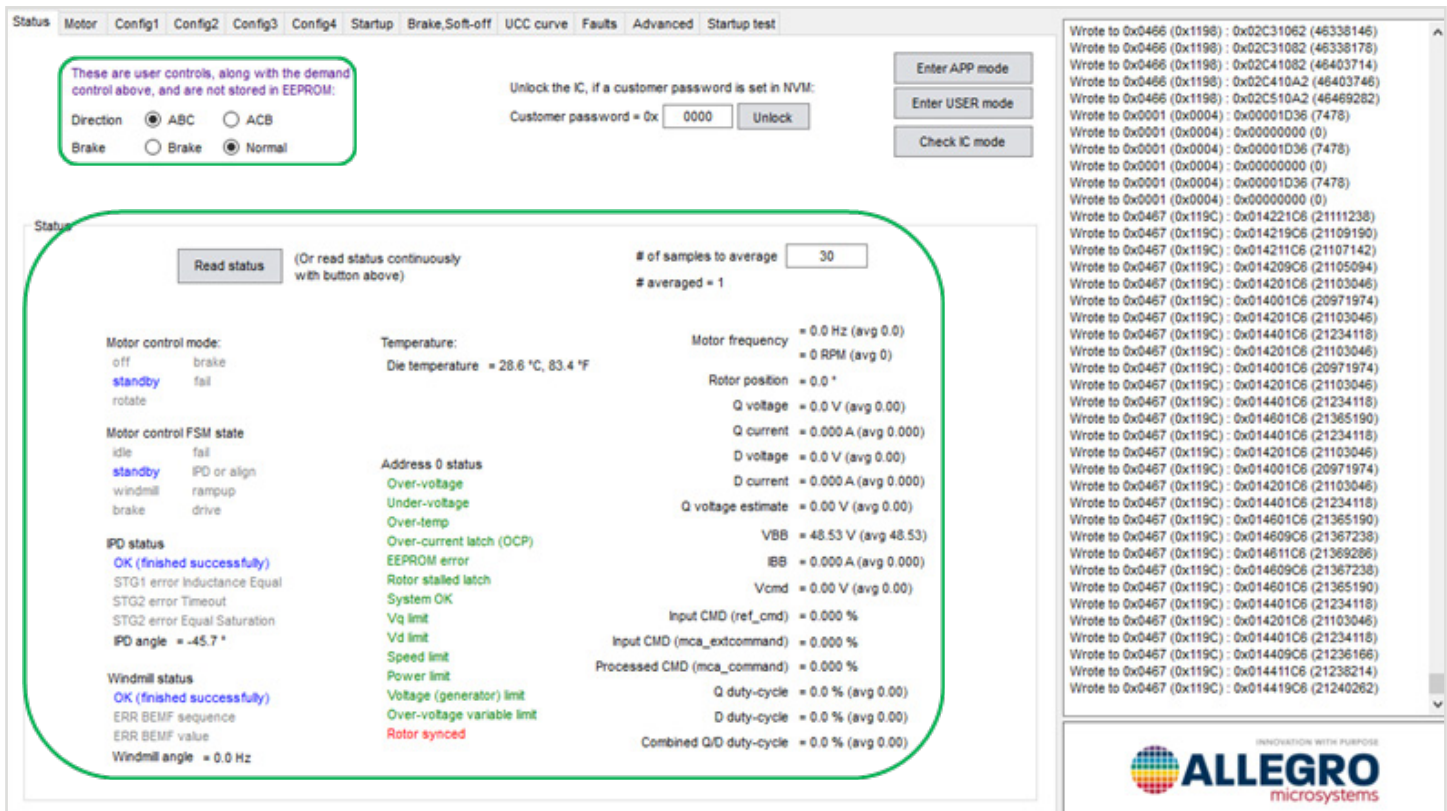

Figure 25: GUI—Status Tab

## Motor Tab

Refer to the Basic Startup of Motor section.

### MOTOR CONTROL MODE AND STATE

A89333 implements the FOC algorithm through a state machine, composed of four modes and six distinct states.

The four modes of the motor controller application (MCA) are:

- Standby (SBY) mode: Activated after completion of the system startup routine or after receipt of a command to stop driving the motor (MCA finite state machine, FSM, enters standby state. (See Figure 26).
- Rotate mode: Activated after receipt of a command to start the motor (upon exit from the standby state).
- Brake mode: Activated after receipt of a command to brake the motor.
- Fail mode: Activated after detection of an enabled fault. Active fail mode is reported by activation of the nFLT pin.

The states of the MCA FSM are shown in Figure 26.

NOTE: For a detailed description of the MCA FSM states, refer to the A89333 Datasheet.

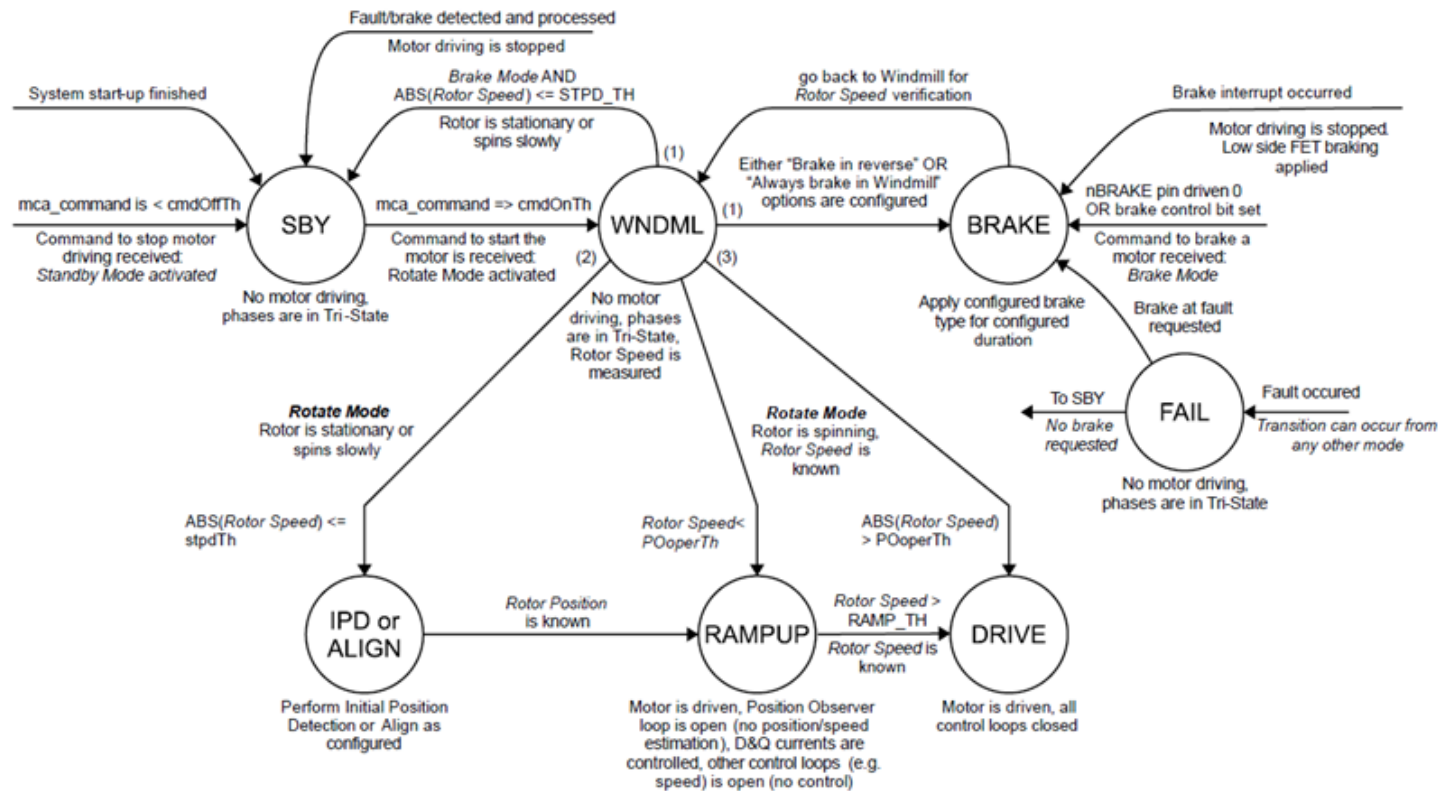

Figure 26: MCA FSM

## CONFIG2 TAB

### PI Controller Parameters

In this tab, there are the PI current controller variables, position observer variables and the PI speed control variables. The PI controller's variables are expressed as values in powers of 2, increase the PI gain by one means a power of 2. The tuning of the PI parameters is explained in the Basic Startup of Motor section Step 6: Set Startup Variables.

### Regenerative Mode—Antivoltage Surge

When a motor is driven, energy is transferred from the power supply to the motor. Some of this energy is stored in the form of inductive and mechanical energy. If the speed command suddenly reduces such that the BEMF voltage generated by the motor is greater than the voltage applied to the motor, the mechanical energy of the motor transfers as electric power to the power supply and—if the reverse-protection diode is present—the  $V_{BB}$  voltage increases. During the deceleration, the motor starts to

produce regenerative current. The regenerative current can be limited using the SFOC\_CURR\_GEN\_LMT parameter.

Due to the reverse-protection diodes, the current cannot be absorbed by the power supply during regenerative braking; therefore, the current can go only toward the DC-link capacitance. The current is integrated in the capacitance, which increases the  $V_{BB}$  voltage.

To prevent  $V_{BB}$  going too high with the risk of breaking the power stage, the configurable  $V_{BB}$  limit can be adjusted using the SFOC\_VBB\_LMT parameter. The A89333 controls the negative current to limit the voltage increase.

To control the regenerative current that comes from the motor, reduce the  $V_{BB}$  limit, as shown in Figure 28.

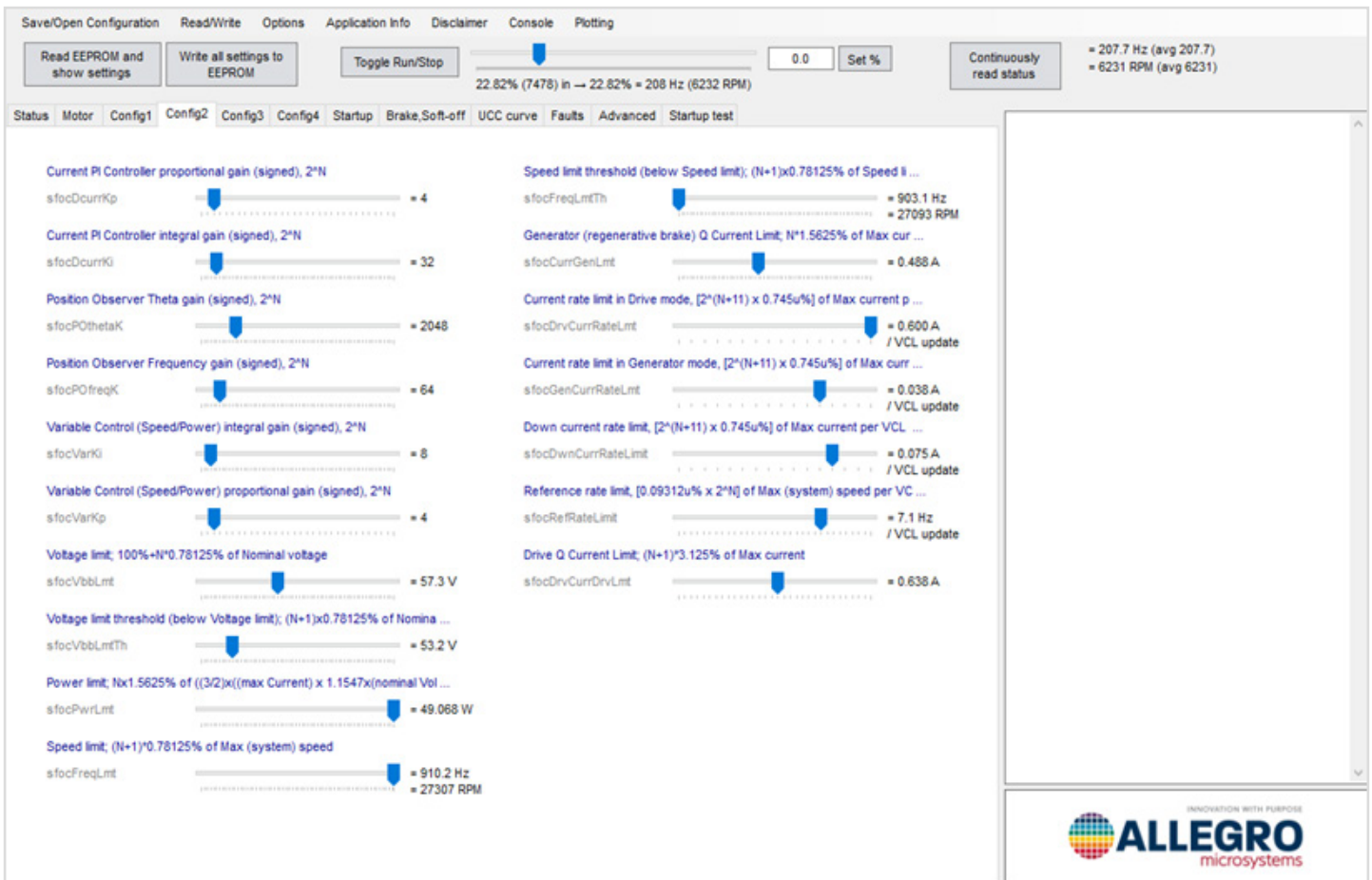
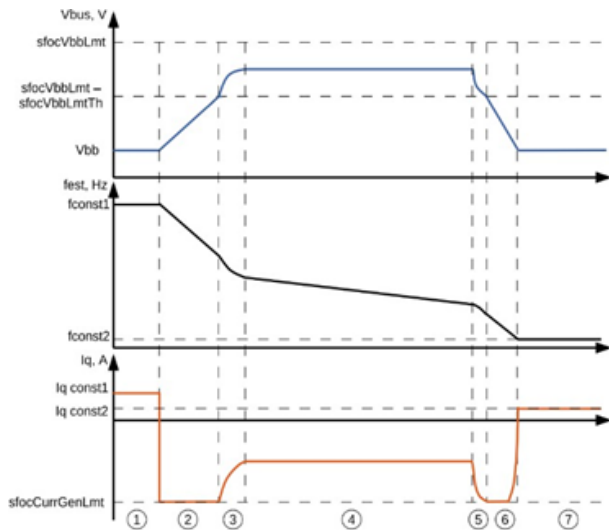

Figure 27: GUI—Config2 Tab



**Figure 28: Regenerative Current Control Using SFOC\_VBB\_LMT**

The A89333 can limit the  $V_{BB}$  pump up using the following parameters:

- SFOC\_VBB\_LMT sets the limit of the  $V_{BB}$  pump up in generator mode.
- SFOC\_VBB\_LMT\_TH increase leads to a smoother approach to the  $V_{BB}$  limit defined by SFOC\_VBB\_LMT.

NOTE: These  $V_{BB}$  limit parameters are active only in generator mode; they are not engaged during low-side brake.

To prevent  $V_{BB}$  pump-up when deceleration is required, the SFOC\_CURR\_GEN\_LMT parameter must be set to 0. During this state, the motor is controlled in coast mode up to the reference.

If  $V_{BB}$  pump-up is allowed, this parameter can be set to a value that differs from 0 and  $V_{BB}$ . The pump up is limited to SFOC\_VBB\_LMT.

NOTE:  $V_{BB}$  limits acts reducing the magnitude of braking current. Because current is proportional to torque, this limit reduces the braking force.

### Power Limit

The SFOC\_PWR\_LMT parameter limits the maximum power and it works for all speed, torque, and power modes, and it is particularly useful in speed and torque modes.

### Speed Limit

The SFOC\_FREQ\_LMT parameter limits the maximum rotation speed. It works for all the controlling modes—speed, torque and power—but is typically used in power and torque modes.

To limit the rotor frequency up to the limit specified by the SFOC\_FREQ\_LMT parameter, a threshold must be set in the SFOC\_FREQ\_LMT\_TH parameter. This threshold must be less than the SFOC\_FREQ\_LMT parameter. A high SFOC\_FREQ\_LMT\_TH value achieves a smoother approach to the SFOC\_FREQ\_LMT limit.

When the motor frequency exceeds SFOC\_FREQ\_LMT\_TH, the controller starts to limit the rotor frequency by acting on the driving current.

### Motor Drive Current Limit and Slew Rate Control

Motor current during the drive phase is limited by SFOC\_DRV\_CURR\_DRV\_LMT, and the slope of the current is limited by SFOC\_DRV\_CURR\_RATE\_LMT (when current rises) and SFOC\_DWN\_CURR\_RATE\_LIMIT (when current decreases). The rate limit is used to smooth the current increase or decrease: Small values result in slow dynamics, and higher values result in a faster response.

NOTE: It is important to act on the rate limits only after the motor has rotated properly in the closed-loop mode.

SFOC\_DRV\_CURR\_DRV\_LMT also limits the IBB current. IBB is proportional to SFOC\_DRV\_CURR\_DRV\_LMT.

### Command Reference Limit

In speed mode and power mode, the maximum rate of command change can be limited using the SFOC\_REF\_RATE\_LMT parameter. This feature can be useful to prevent sudden changes in the torque applied to the motor, which could result in acoustic noise.

NOTE: The SFOC\_REF\_RATE\_LMT parameter also works during deceleration.

In torque mode, the SFOC\_REF\_RATE\_LMT parameter has no influence. The reference variable in torque mode is motor current. The rate of the current change can only be limited through the SFOC\_DRV\_CURR\_RATE\_LMT and SFOC\_DWN\_CURR\_RATE\_LIMIT parameters.

## CONFIG 3 TAB

### BEMF Compensation

The BEMF compensation algorithm compensates the side harmonics produced by the motor. The compensation is used to reduce torque ripple, allowing reduced acoustic noise and preservation of the motor bearings.

NOTE: The BEMF compensation algorithm is useful when the motor BEMF voltage does not have a pure sinusoidal shape.

The algorithm can compensate only one harmonic component. The suggested harmonic component of focus is the one that causes the greatest distortion; i.e., the one with the greatest amplitude, excluding the fundamental. Compensation for the undesired harmonic is made using the BEMF\_COMP\_N and BEMF\_COMP\_AMPLITUDE parameters.

Using the procedure reported in the Basic Startup of Motor section, BEMF can be measured and the harmonic content of the voltage can be analyzed.

The phase of the harmonics can be determined using the fast Fourier transform (FFT) plot of the BEMF waveform. The side odd harmonic could be in phase or out of phase with respect to the fundamental:

- If the BEMF voltage has peaks in the shape of Figure 30, set BEMF\_COMP\_PHASE to 0°.

- If the BEMF voltage has saddles in the shape of Figure 31, set BEMF\_COMP\_PHASE to 180°.

This method, used to recognize the phase of the harmonic, is not useful for even harmonics.

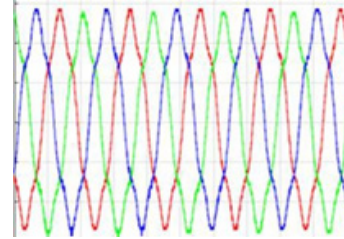

Figure 30: Harmonics in Phase with Fundamental

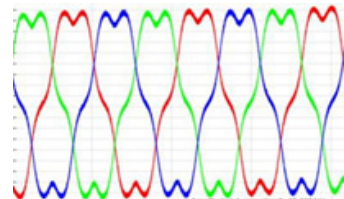

Figure 31: Harmonics 180 Degrees Out of Phase from Fundamental

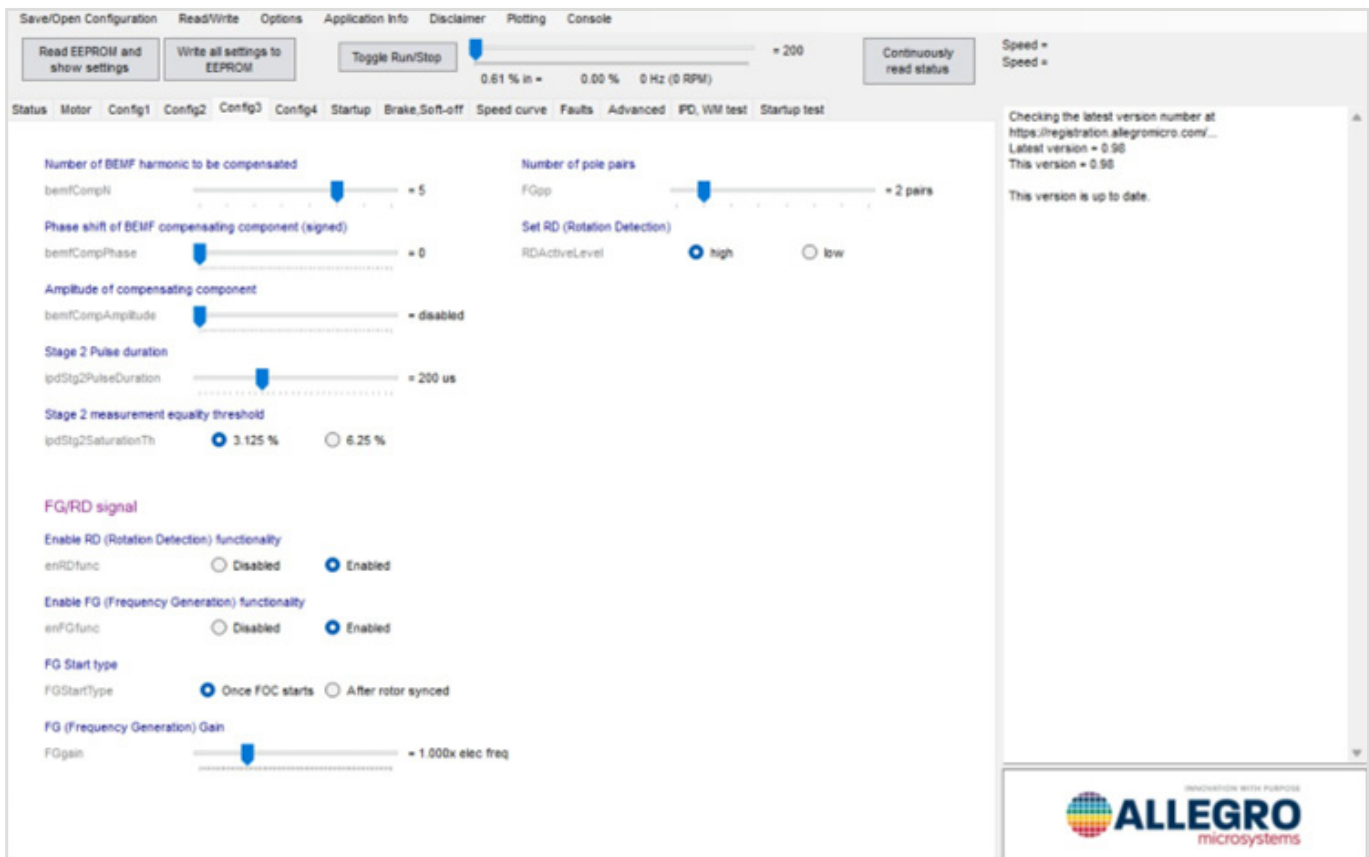

Figure 29: GUI—Config3 Tab



## Procedure to Set the Correct BEMF Compensation

### 1. Order of Side Harmonic

Through an FFT plot of the BEMF voltages, the side harmonic with the greatest amplitude in addition to the fundamental can be determined. In the example of Figure 32, the component with the greatest amplitude after the fundamental is the fifth harmonic.

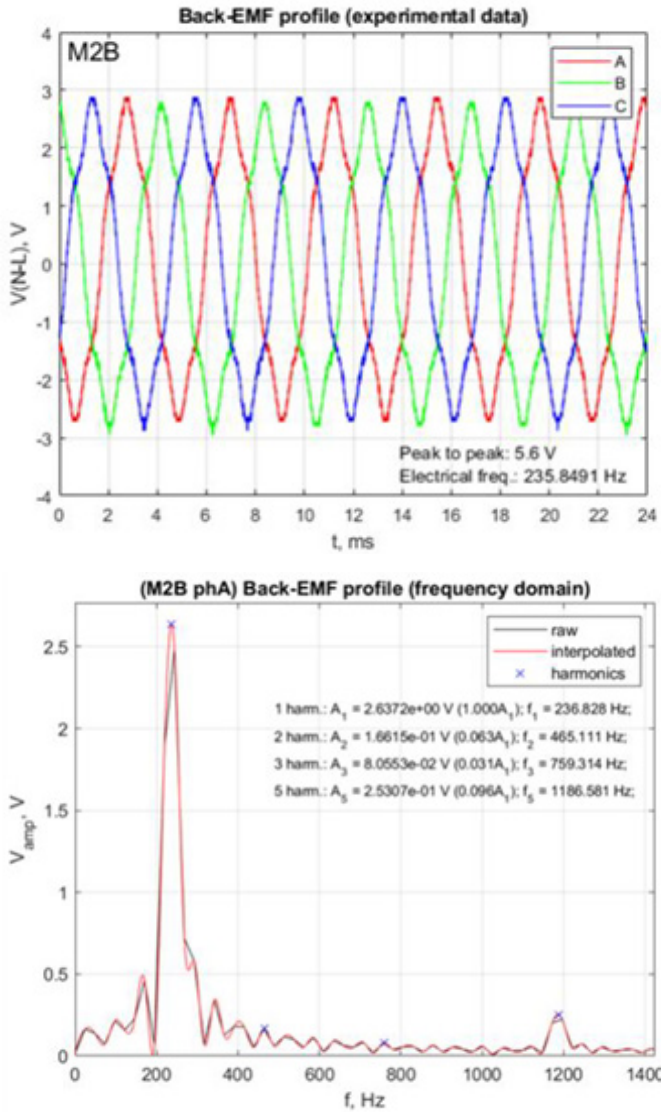

Figure 32: Measured BEMF (top) and FFT of Measured BEMF (bottom)

### 2. Amplitude

Once BEMF\_COMP\_N is set, step through the BEMF\_COMP\_AMPLITUDE parameters to select the value that produces the best sinusoidal phase current by looking at one of the phase currents with the oscilloscope.

The phase current of a motor that has the fifth harmonic without the compensation algorithm is shown in Figure 33 and with compensation applied in Figure 34. It is clearly evident that the phase current is completely compensated and the shape obtained is sinusoidal.

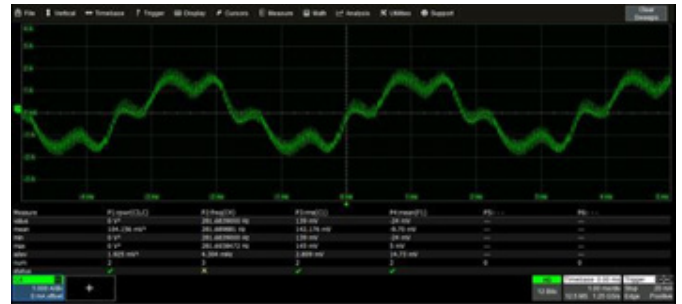

Figure 33: Motor Current Without Compensation

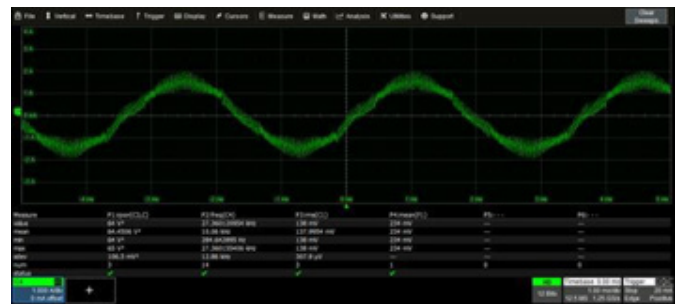

Figure 34: Motor Current With Compensation

## IPD Settings

The configurable IPD settings on the Config3 tab are:

- `IPD_STG2_PULSE_DURATION`: Sets the injection pulse duration.
- `IPD_STG2_SATURATION_TH`: Sets the trigger level of current difference.

To configure the IPD:

- Start with a low `IPD_STG2_PULSE_DURATION` value.
- Perform multiple starts, where `IPD_STG2_PULSE_DURATION` is increased for each start until the difference between the peak values of the two currents,  $I_1$  and  $I_2$ , is at least 3.125% or 6.25%, depending on the value selected in `IPD_STG2_SATURATION_TH`.
- The peak value of  $I_1$  and  $I_2$  must be less than the maximum system current in order to be correctly read by the device.

Three output voltages and the phase current related to phase A are shown in Figure 35.



Figure 35: Output Voltages and Phase A Current

## FG

The FG signal is a square wave signal that is proportional to the frequency of the motor.

After the rotor synchronizes and FOC starts, the FG signal is available in the ramp-up state or the drive state, according to `FG_START_TYPE`.

The `FG_GAIN` parameter in NVM can be used to scale the output FG frequency based on internal electrical frequency; this allows the setting of the FG frequency to differ from the actual electrical frequency.

`FG_PP` is used to set the number of motor pole-pairs.

## RD

When the RD feature is enabled (`EN_RD_FUNC`), the stalled condition is reported on the FG/RD pin according to the `RD_ACTIVE_LEVEL` parameter in NVM:

- If `RD_ACTIVE_LEVEL = 0`, FG/RD pin is set high in the event of a stalled condition
- If `RD_ACTIVE_LEVEL = 1`, FG/RD is set low in the event of a stall condition. The pin remains in the active level for the duration of the presence of the stalled latch.

## CONFIG 4 TAB

### Clock Compensation

When the PWM duty cycle is set as the external command, to achieve greater speed-control accuracy, a clock-compensation feature can be used to synchronize the internal clock of the IC with the external PWM signal frequency. This eliminates the requirement of the precision external resistor on the ROSC terminal because the external PWM signal is used to compensate for the inaccuracy of the integrated oscillator and enables speed accuracy better than 0.1%. This requires a highly accurate and stable external PWM signal.

This feature is activated using `CLK_COMP_ENABLE`.

The input maximum frequencies of the external PWM signal are fixed and must be specified using the `CLK_COMP_REF` parameter.

The input duty cycle of the PWM signal must be greater than 0% and less than 99% to detect the frequency (close to 50% is recommended). If a 0% or 100% duty cycle value is applied, the clock compensation does not work properly.

### Pull-Up Enable

Pull-up control of the Config 4 Tab of the GUI is used to enable/disable the internal pull-up of various pins:

- `IPUP_PWM_SPD_DIS`: Controls the 5 V internal pull-up of the PWM/SPD pin.
- `IPUP_FG_RD_DIS`: Controls the 12 V internal pull-up of the FG/RD pin.
- `IPUP_NBRAKE_DIS`: Controls the 5 V internal pull-up of the nBRAKE pin.

### Gate Driver Control

The `PWM_GD_SLEW_RATE` parameter is used to control the slew rate of the external MOSFETs and can be estimated by the  $Q_{GD}$  specification of MOSFET and the chosen gate drive current according to:

Equation 7:

$$t_{\text{slew}} = Q_{\text{GD}} / (I_{\text{SRC}} \text{ or } I_{\text{SNK}}).$$

A high slew rate produces high emissions, voltage spikes and coupling. This effect can be reduced using a smaller slew rate; however, a smaller slew rate can increase power dissipation, so it is important to find the correct trade-off among all the factors.

Increasing the slew rate reduces the dead time needed to avoid a short, but increases the probability of introducing electromagnetic interference (EMI) through coupling.

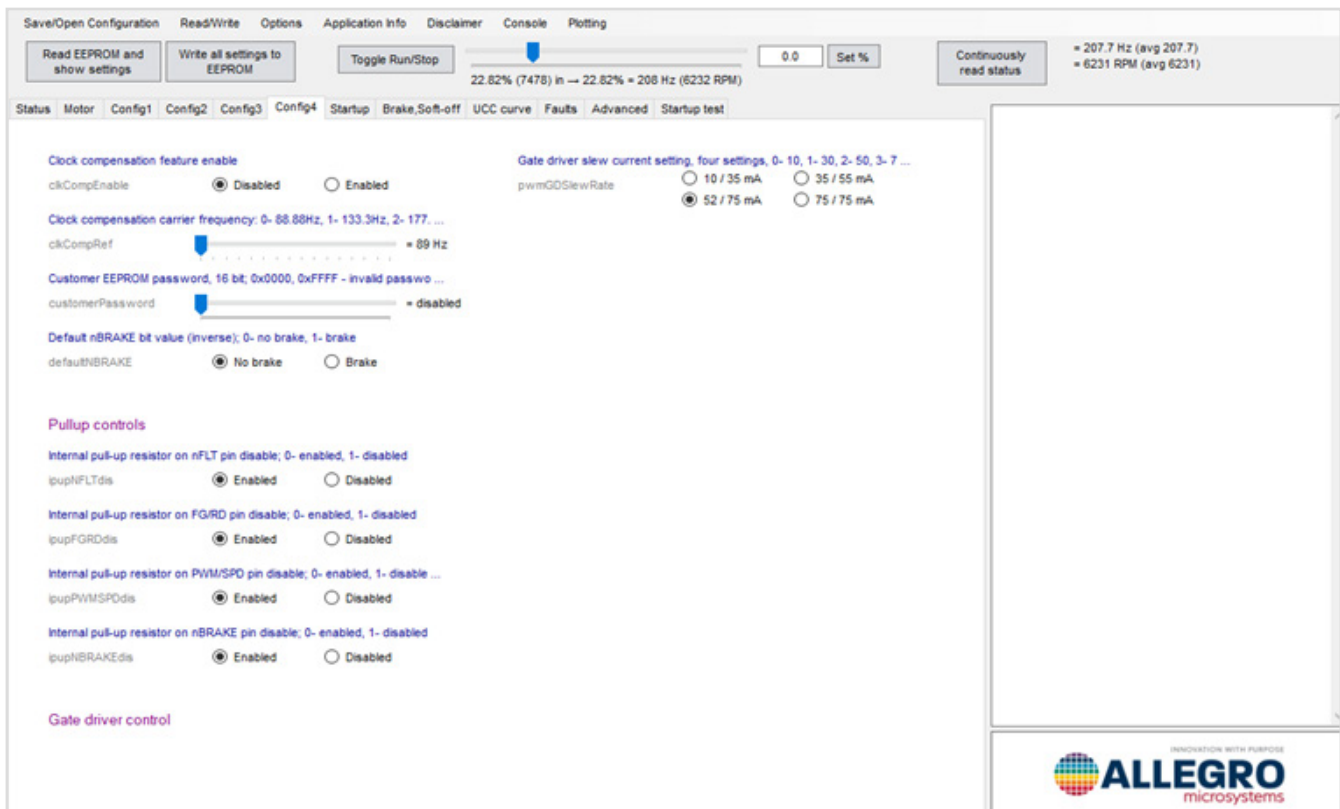

Figure 36: GUI—Config4 Tab

## STARTUP TAB

The startup tab is detailed in the Basic Startup of Motor section Step 6: Set Startup Variables.

Save/Open Configuration Read/Write Options Application Info Disclaimer Console Plotting

Read EEPROM and show settings Write all settings to EEPROM Toggle Run/Stop 0.0 Set % Continuously read status = 207.7 Hz (avg 207.7) = 6231 RPM (avg 6231)

22.82% (7478) in -- 22.82% = 208 Hz (6232 RPM)

Status Motor Config1 Config2 Config3 Config4 Startup Brake,Soft-off UCC curve Faults Advanced Startup test

Align type: 0- Align, 1- IPD  
AlignType  Align  IPD

Align D current reference;  $(N+1)^3 \cdot 125\%$  of Max current  
sfocAlignDcurRef = 0.450 A

Align time;  $2048 \cdot (N+1)$  VCL updates  
sfocAlignTime = 1667.2 ms

Ramp-up time;  $[40 + 256kh]$  VCL updates  
sfocRampTime = 631 ms

Ramp-up frequency (speed) rate;  $(N+1)^0 \cdot 0.0244140625\%$  of Max (syst ...  
sfocRampStep = 34.7 Hz / s  
End freq = 21.9 Hz

Ramp-up D current reference;  $(N+1)^3 \cdot 125\%$  of Max current  
sfocRupDcurRef = 0.450 A

Command On threshold;  $(N+1)^0 \cdot 390625\%$ , post-UCC processing  
cmdOnTh = 9.38 %

Command Off threshold;  $N^0 \cdot 390625\%$ , post-UCC processing  
cmdOffTh = 7.03 %

AC/DC Align Type: 0- DC Align, 1- AC Align  
sfocACDCAlignType  DC Align  AC Align

Align DiQ current PI Controller integral gain (signed),  $2^N$   
sfocAlignDQcurrI = 8

Align DiQ current PI Controller proportional gain (signed),  $2^N$   
sfocAlignDQcurrP = 2

ALLEGRO microsystems

## BRAKE, SOFT-OFF TAB

### Pulsed Low-Side Braking

When BRAKE\_IF\_OFF\_EN is enabled, low-side braking is applied if the IC is commanded to turn off. Four parameters are used to define the low-side braking behavior:

- BRAKE\_FET\_PULSE\_AMOUNT
- BRAKE\_SEQ\_LENGTH
- BRAKE\_FET\_ON\_DURATION
- BRAKE\_FET\_OFF\_DURATION

During low-side braking, current could be high. The A89333 uses a switching method (pulsed low-side braking) whereby the low-side MOSFETs are closed for the duration of BRAKE\_FET\_ON\_DURATION and open for the duration of BRAKE\_FET\_OFF\_DURATION, as follows:

1. One low-side brake pulse is:
  - A. On for the duration of BRAKE\_FET\_ON\_DURATION.
  - B. Off for the duration of BRAKE\_FET\_OFF\_DURATION.
2. This pulse is repeated for the number of times set by BRAKE\_FET\_PULSE\_AMOUNT.
3. The result of BRAKE\_FET\_PULSE\_AMOUNT can be again repeated by BRAKE\_SEQ\_LENGTH.

This approach allows the speed of the rotor to be dampened until it is zero. This braking sequence is illustrated in Table 3.

Table 3: Braking Sequence

Braking Sequence					
On	Off	On	Off	On	Off
Pulse Amount		Pulse Amount		Pulse Amount	
Sequence Length					

### Continuous Low-Side Braking

Continuous low-side braking is also available: When BRAKE\_FET\_OFF\_DURATION is set to zero and BRAKE\_FET\_ON\_DURATION is set to the maximum value, the low side is ON during braking. This reduces the time needed to stop the motor. However, it is important to ensure that the maximum current that the MOSFETs can support is not exceeded.

### High-Current Damage Prevention

The following parameters control another feature used to prevent high-current damage to MOSFETs during braking:

- BRAKE\_FREQ\_TOO\_HIGH\_TH
- BRAKE\_FREQ\_TOO\_HIGH\_COAST\_TI

If the motor speed (electrical cycle) exceeds BRAKE\_FREQ\_TOO\_HIGH\_TH when the brake command is received, the motor coasts for the duration defined by BRAKE\_FREQ\_TOO\_HIGH\_COAST\_TI. Before braking is activated, the speed is checked again. Braking is applied when speed is less than BRAKE\_FREQ\_TOO\_HIGH\_TH.

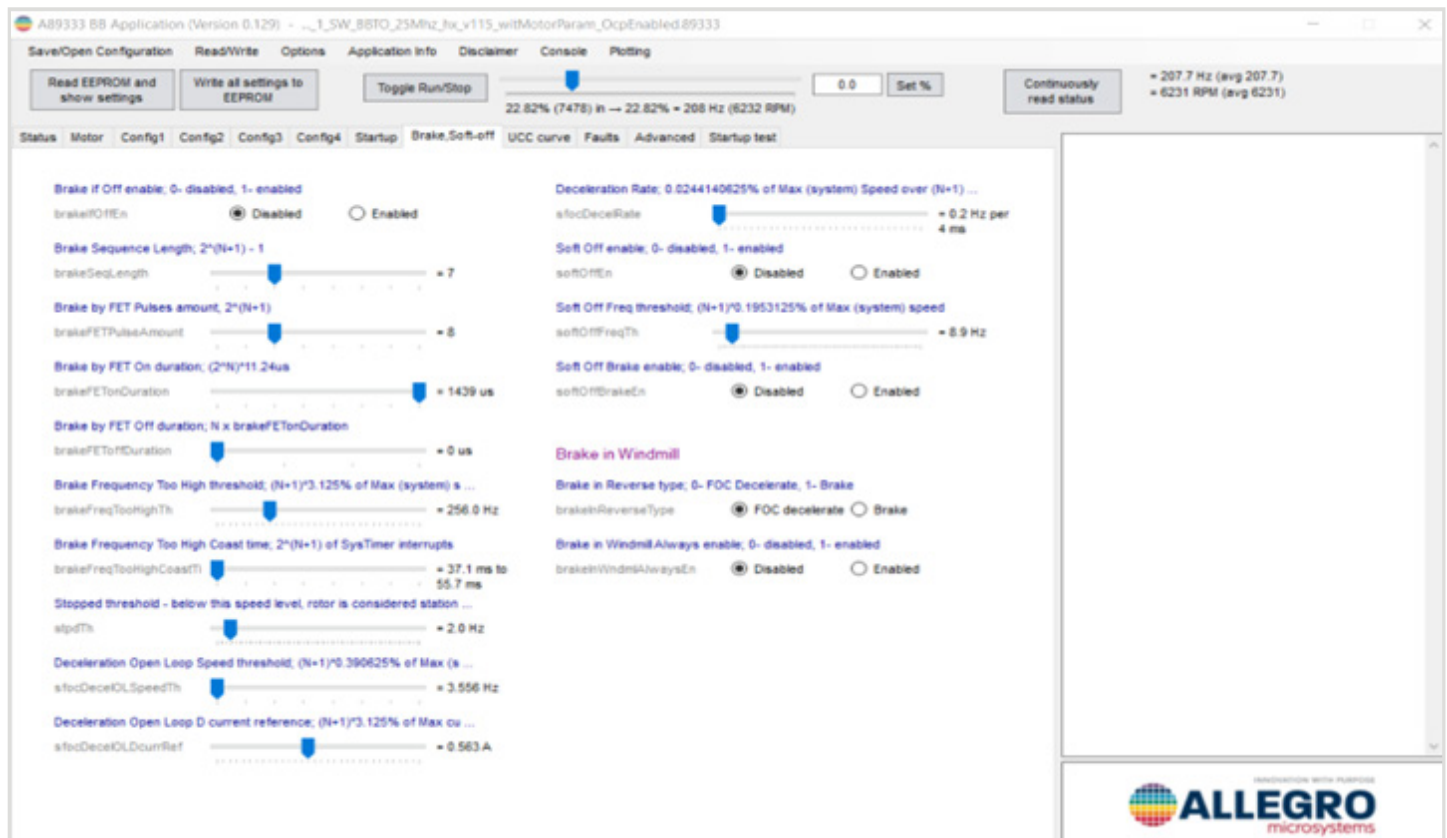

Brake, Soft-Off Tab Contains Many Settings Related to Braking

## Pulsed Low-Side Braking

During the braking phase,  $V_{BB}$  experiences pump-up caused by diodes inserted between the power supply and the VBB pin. The diodes block the current that returns to the power supply, so the current is forced toward the capacitances, which "pumps up" the voltage trough the capacitor terminal. During pulsed braking, current decreases linearly and speed slowly decreases to a halt.



Figure 37: Pulsed Low-Side Braking

## Continuous Low-Side Braking

During continuous braking, the low-side MOSFETs are always closed and the brake is constantly applied. In this case,  $V_{BB}$  pump-up is not present because the current is shorted by the low-side MOSFETs. Continuous braking engages quicker and slows the motor/rotor to a halt faster than pulsed braking.



Figure 38: Continuous Low-Side Braking

## Soft-Off Deceleration

If `SOFT_OFF_EN` is enabled when a stop command is received, the motor decelerates in a closed loop (see Figure 39, Area 1). This is achieved by decreasing the reference command using the rate configured by `SFOC_DECEL_RATE`. Depending on the correlation between `SFOC_DECEL_OL_SPEED_TH` and `SOFT_OFF_FREQ_TH`, two operating scenarios are possible:

- `SFOC_DECEL_OL_SPEED_TH > SOFT_OFF_FREQ_TH`:
  1. Closed-loop deceleration
  2. Open-loop deceleration
  3. Brake/Free-run:
    - For brake, `SOFT_OFF_BRAKE_EN = 1`
    - For coast, `SOFT_OFF_BRAKE_EN = 0`
- `SFOC_DECEL_OL_SPEED_TH < SOFT_OFF_FREQ_TH`:
  1. Closed-loop deceleration
  2. No open-loop deceleration
  3. Brake/Free-run:
    - For brake, `SOFT_OFF_BRAKE_EN = 1`
    - For coast, `SOFT_OFF_BRAKE_EN = 0`

NOTE: During the closed-loop deceleration phase, regenerative current is produced. If `SFOC_CURR_GEN_LMT = 0`, regenerative current is limited to 0 and the motor coasts. `SFOC_DECEL_OL_D_CURR_REF` sets the driving current during open-loop deceleration.

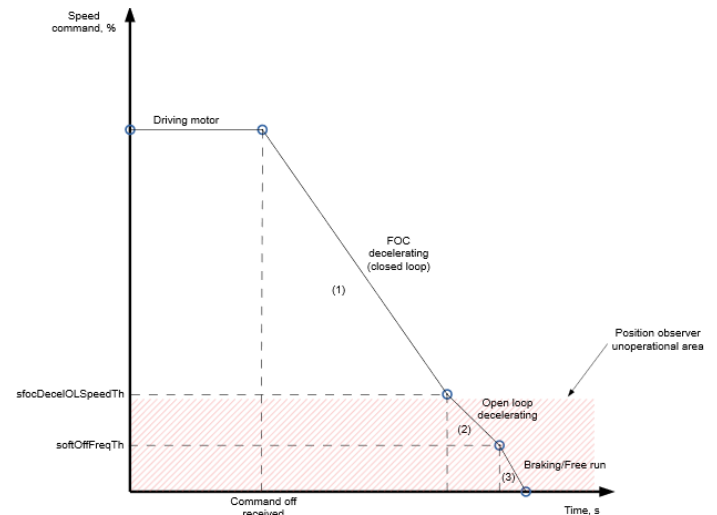

Figure 39: Soft-Off Deceleration

## ADVANCED TAB

### Soft Start

Soft start limits current before align or ramp-up and avoids the onset of inrush current caused by the presence of current scaling references that are required in the align and ramp-up modes.

### Quiet Start

To achieve quieter operation during the open-loop to closed-loop (OL-CL) transition, a quiet-start feature can be enabled by selecting the value of phase-current limit (SFOC\_START\_CURR\_LMT) at the OL-CL transition. It is also possible to reduce the current in the ramp up (SFOC\_RUP\_D\_CURR\_REF) toward the end of the open-loop ramp-up period by properly configuring the OL-CL transition duration (SFOC\_QUIET\_START\_TIME). When the current level is closer to the required current level in the feedback control, transition noise is minimized.

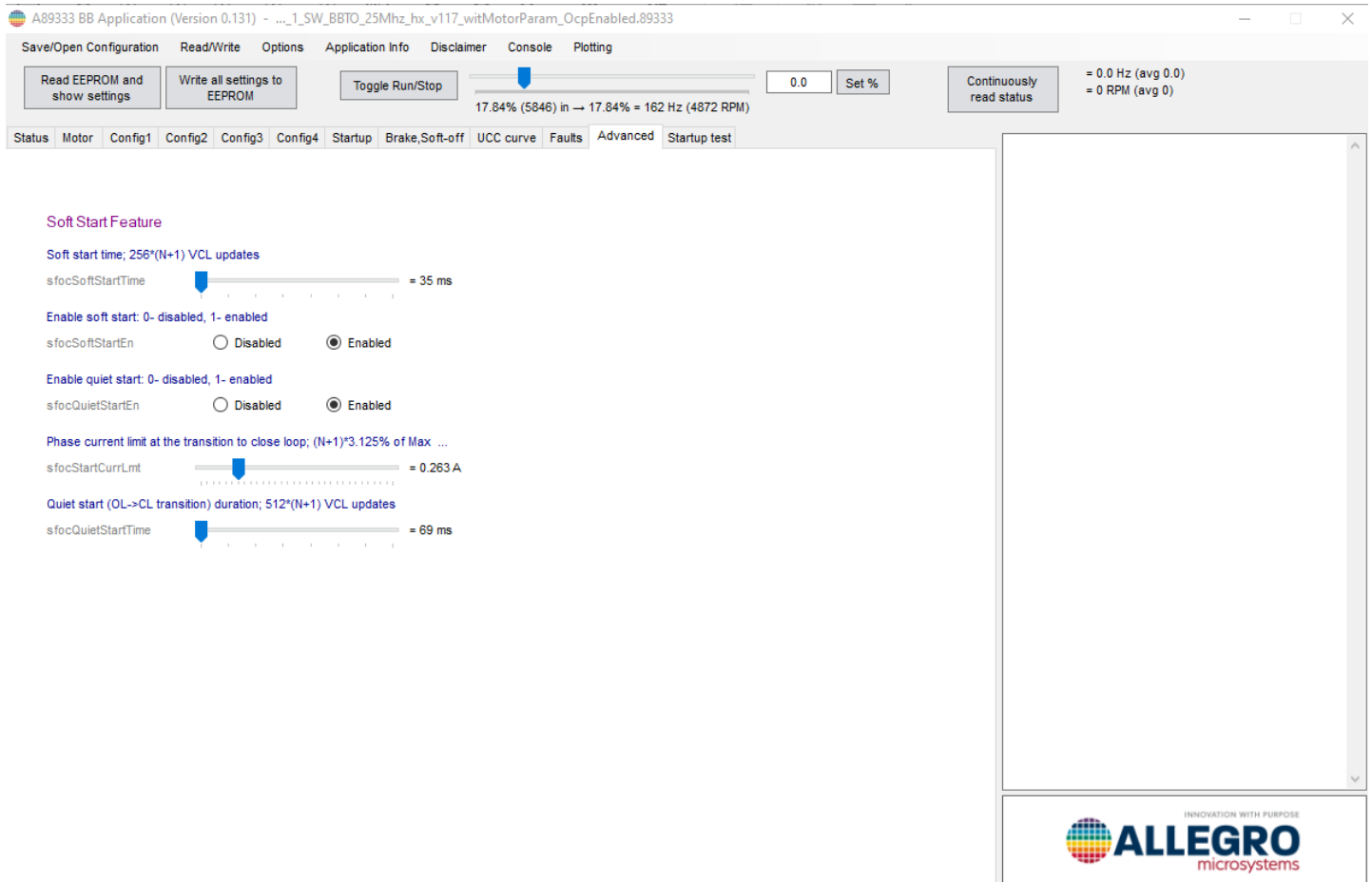

Figure 40: GUI—Advanced Tab

## SPEED/UCC CURVE

The motor command is passed through a universal curve controller (UCC; see GUI access in Figure 41) to create an arbitrary command profile, then to the FOC algorithm.

The UCC input is unsigned ( $MCA\_EXT\_COMMAND$  [LSB]) and the output is signed ( $MCA\_EXT\_COMMAND$  [LSB]), as shown in Figure 42.

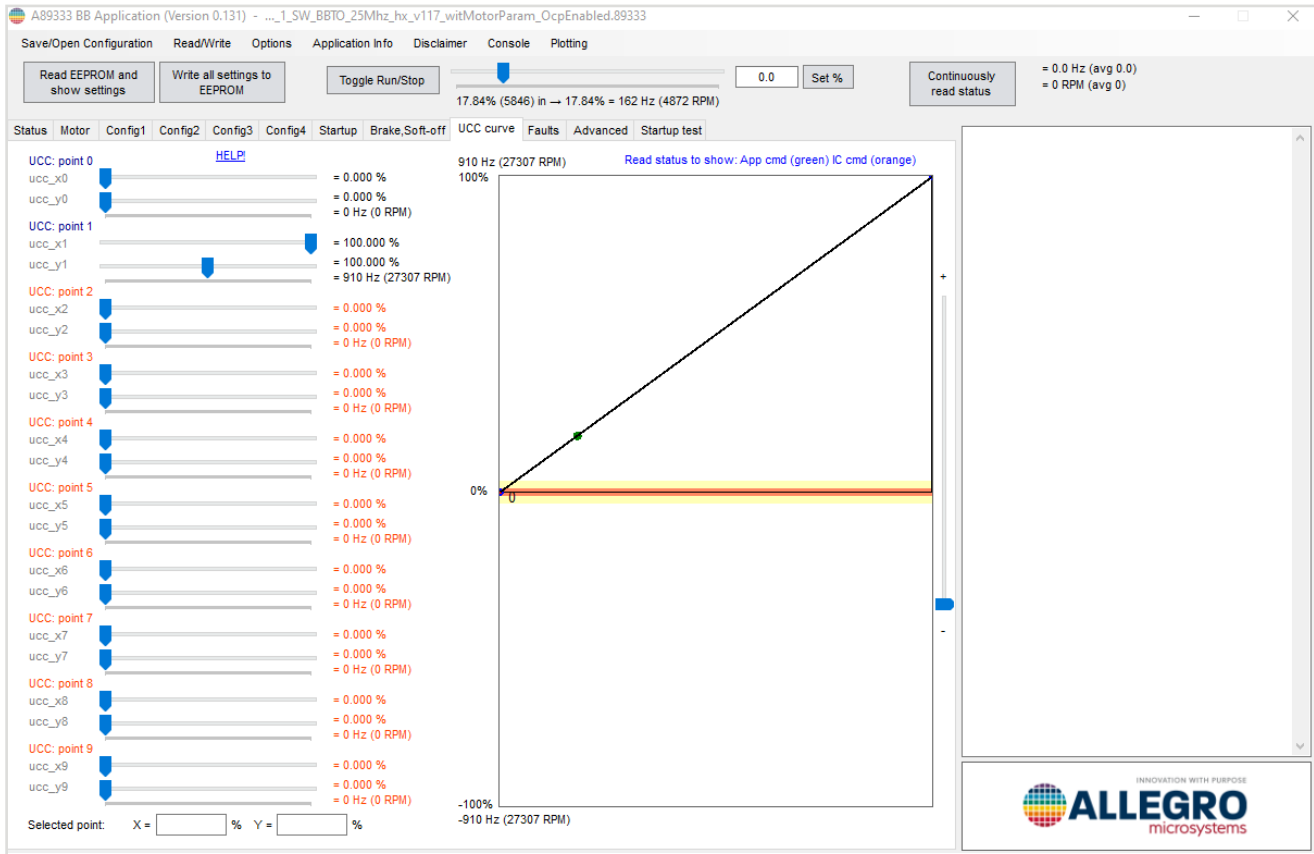

Figure 41: GUI—UCC Curve Tab

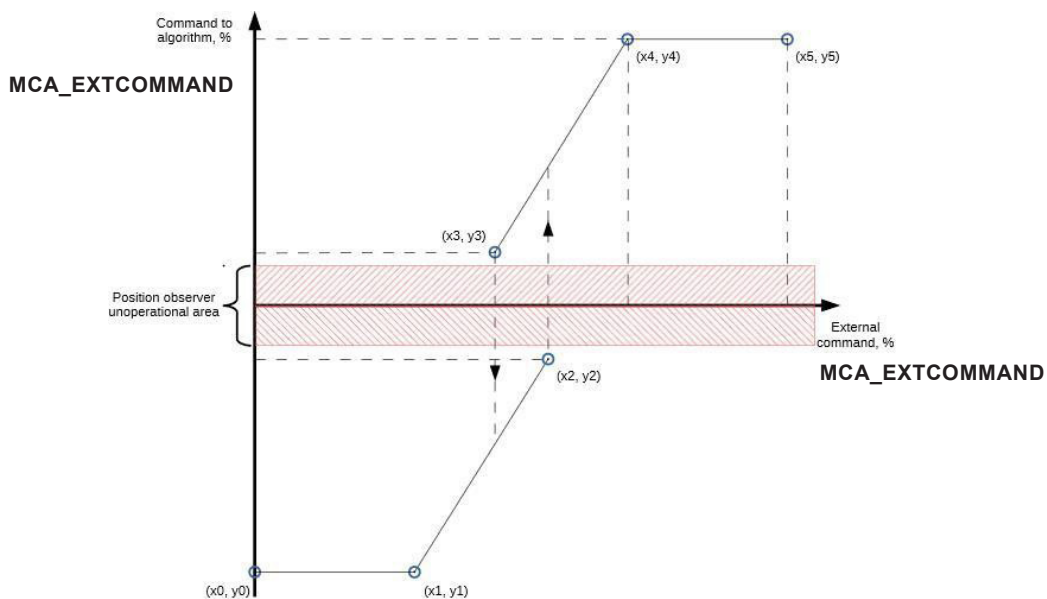

Figure 42: UCC Transfer Function from External Command to FOC Command



The UCC is a transform curve defined by corner points. Each point has a specific input value that corresponds to an output value. The values between the points are calculated using linear interpolation. Up to 10 corner points can be defined and saved in the EEPROM. Definition of all corner points available is not required—only as many as are needed for the desired curve. The UCC curve examples that follow are just some examples. Many possibilities exist.

**UCC Curve Examples**

- The following base configuration (default curve) starts from zero and transitions linearly to the maximum value; if used, remapping is not required:

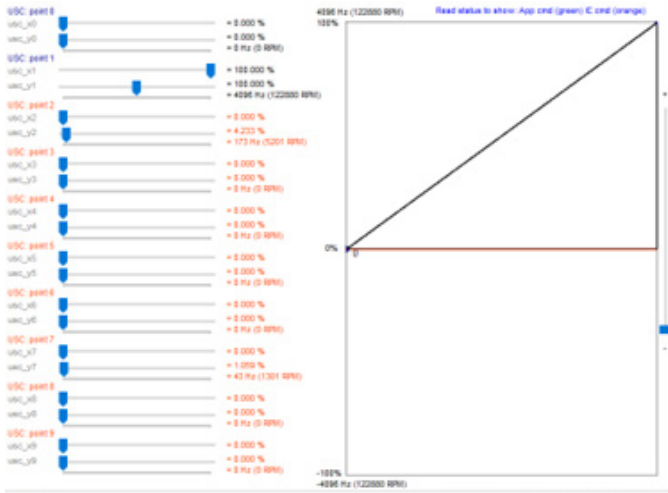

- The following speed curve can be used to avoid the resonant frequency of the motor, if required:

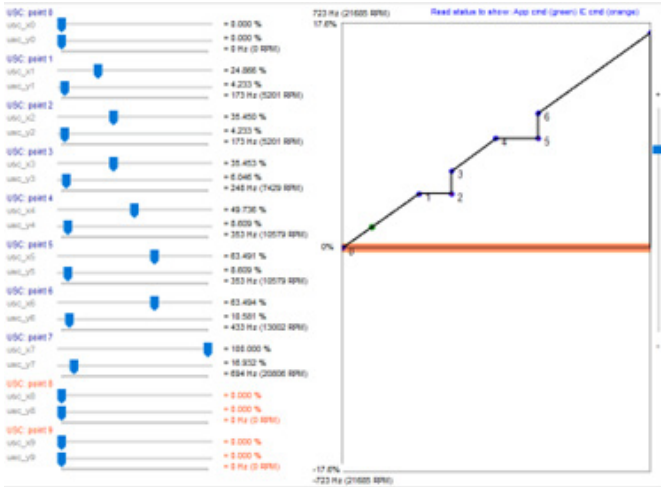

- Hysteresis can be implemented by setting the input value of an address lower than the input value of the previous address, for example, as follows:

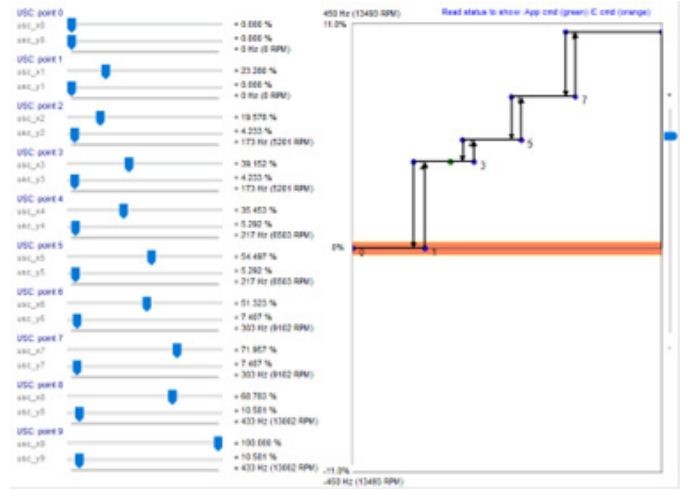

In this example, as the input demand rises, the output demand jumps to the next-higher level, at the vertical lines on the right of each transition; when the input demand reduces, the output demand reduces to the next-lower level, following the vertical lines on the left of each transition. This prevents output jitter when the input is around a boundary:

- In the following configuration, if the input is:
  - Less than approximately 23%, the motor does not start.
  - Less than 20% and the motor is ON, the motor turns OFF.
  - Between approximately 90% and 96%, the output is 10.6%.
  - Greater than 96%, the output is 0.

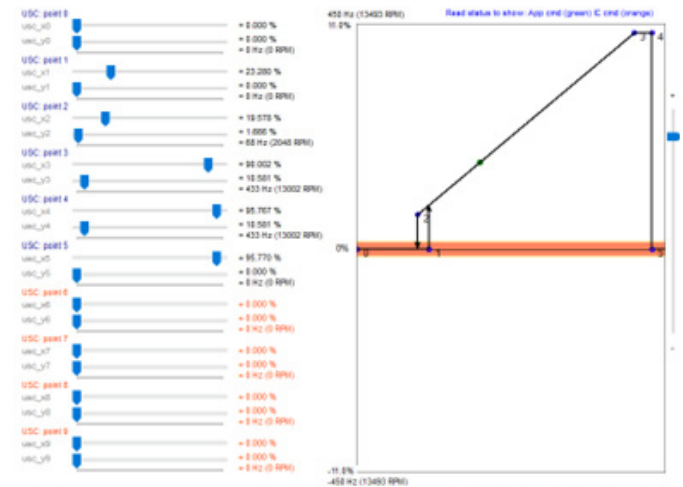

- The following curve can be used when bidirectional operation is required:

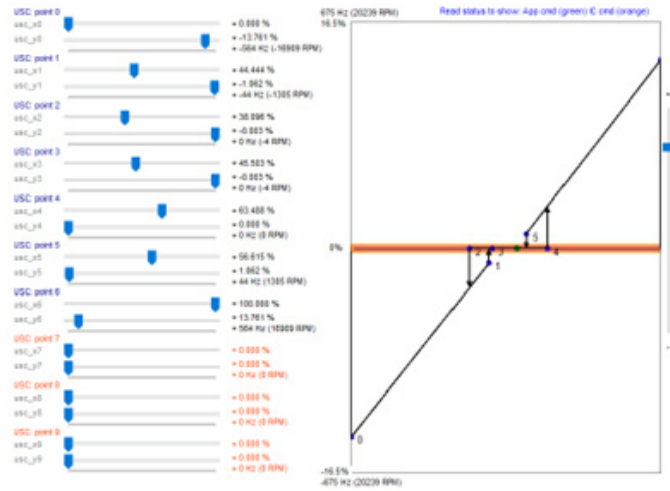

In this case, when the input is:

- 0%, the motor is at the selected maximum speed in the reverse direction.
  - 100%, the motor is at the maximum speed in the forward direction.
  - 50% (approximately), the motor is stopped.
- NOTE: the SFOC\_FREQ\_RES parameter has four settings. Each setting corresponds to one of four maximum system speeds (455 Hz, 910 Hz, 1820 Hz, and 3641 Hz) as shown in the motor tab. The maximum system speed must be faster than the maximum motor speed. For example, if the maximum speed of the motor is 1000 Hz, the maximum system speed should be set to 1820 Hz, and use of the UCC is recommended to set the maximum speed at 1000 Hz at 100% duty, as shown in Figure 43.



Figure 43: UCC Set to Maximum Speed For Motor Used

## FAULTS TAB

### Faults and Protections

This tab contains all settings related to protection and fault detection features.

Hardware protections include over/undervoltage, overtemperature, and short-circuit protection. Motor control-related faults include lock detect (loss of synchronization) and no-motor start.

Most settings are self-explanatory. Detailed information is available in the datasheet and is not repeated here. The settings for lock detection are presented here.

#### Lock/Stall Detection

Stall detection is used to report the stall condition when the algorithm determines that control has lost synchronization with the motor for various reasons, such as mechanical obstructions, sudden load change, etc.

In drive mode, ROT\_STALL\_DET\_CTRL selects the method used to detect the stall condition. The most common methods are described next. Combinations of these methods are also possible. Users are advised to experiment and select the best option for the specific application.

- Frequency estimation compares the estimated frequency ( $f_{est}$ ) with a threshold value, ROT\_STALL\_TOO\_LOW\_SPEED\_TH; if the estimated

frequency is lower than the threshold, stall detection is triggered.

- BEMF estimation compares the estimated BEMF voltage with a threshold value, ROT\_STALL\_TOO\_LOW\_VBEMF\_TH; if the estimated voltage is less than the threshold, a stall is triggered.
- $V_q$  estimation compares the estimated  $V_q$  with the lower and upper values of  $V_q$  (ROT\_STALL\_DET\_HIGH\_TH and ROT\_STALL\_DET\_LOW\_TH); if the estimated  $V_q$  is not within this range for a time equal to ROT\_STALL\_DET\_TIME\_TH, the stall state is triggered.

NOTE: Stall detection is masked during the open-loop operation (ramp-up) and begins to function only after the controller transitions to closed-loop operation (drive) and the duration of ROT\_STALL\_BLANK\_DUR has elapsed.

After a stall is triggered, the device enters the coast state for a duration set by ROT\_STALL\_RETRY\_TOUT before it makes the next retry attempt.

The restart behavior after a stall is set by ROT\_STALL\_RETRY\_MAX\_ATTEMPTS. For example, this parameter can be set to always retry or to retry only for a programmable number of times.

The screenshot displays the 'Faults' tab in the Allegro GUI. The interface includes a top navigation bar with options like 'Save/Open Configuration', 'Read/Write', 'Options', 'Application Info', 'Disclaimer', 'Console', and 'Plotting'. Below this, there are buttons for 'Read EEPROM and show settings', 'Write all settings to EEPROM', and 'Toggle Run/Stop'. A speed indicator shows '0.00% (0) in → 0.00% = 0 Hz (0 RPM)'. The main area is divided into two columns of settings, each with a slider and a radio button for enable/disable. The left column includes: Over Voltage Protection threshold (80V), Over Voltage Protection enable (Enabled), Over Current Protection VDS comparator threshold (0.5V), Over Current Protection enable (Enabled), Under Voltage Shutdown threshold (7V), Under Voltage Shutdown disable (Enabled), Over Temperature Shutdown disable (Enabled), No motor Start detection enable (Disabled), Rotor Stall Detection control (Freq est), and Rotor Stall Detection Time threshold (278 ms). The right column includes: Rotor Stall Detection High threshold (200.0%), Rotor Stall Detection Low threshold (37.5%), Rotor Stall Too Low Speed threshold (4.4 Hz), Stall Detection BEMF Low threshold (0.374 x (Iq / Max c)), Rotor Start Retry timeout (1169.4 ms to 1188.0 ms), Rotor Start Retry max attempts (always retry), Rotor stall blanking time duration (278 ms), and Rotor Synchronization timeout (556 ms). The bottom right corner features the Allegro Microsystems logo with the tagline 'INNOVATION WITH PURPOSE'.

Figure 44: GUI—Faults Tab

# SCHEMATIC

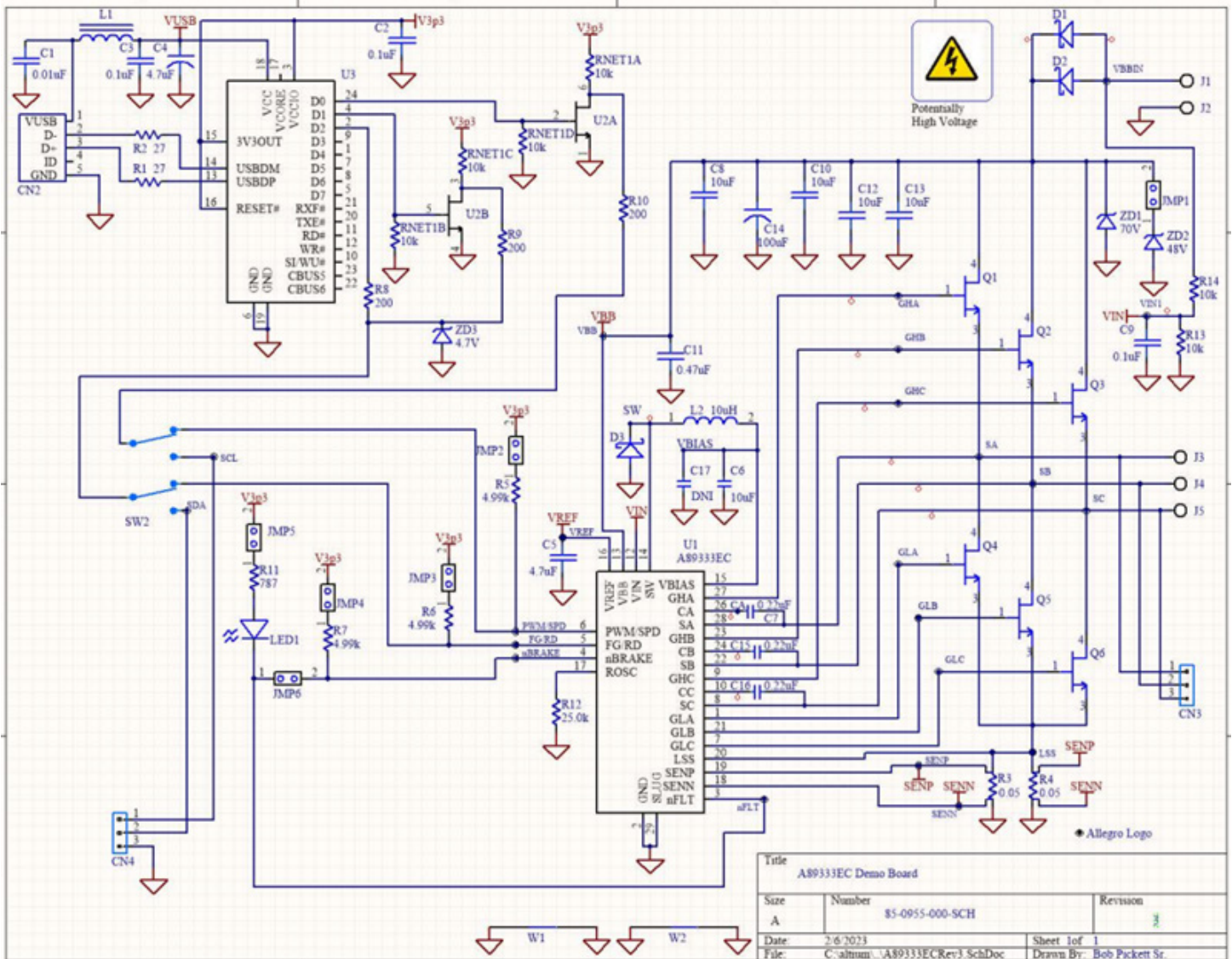

# LAYOUT

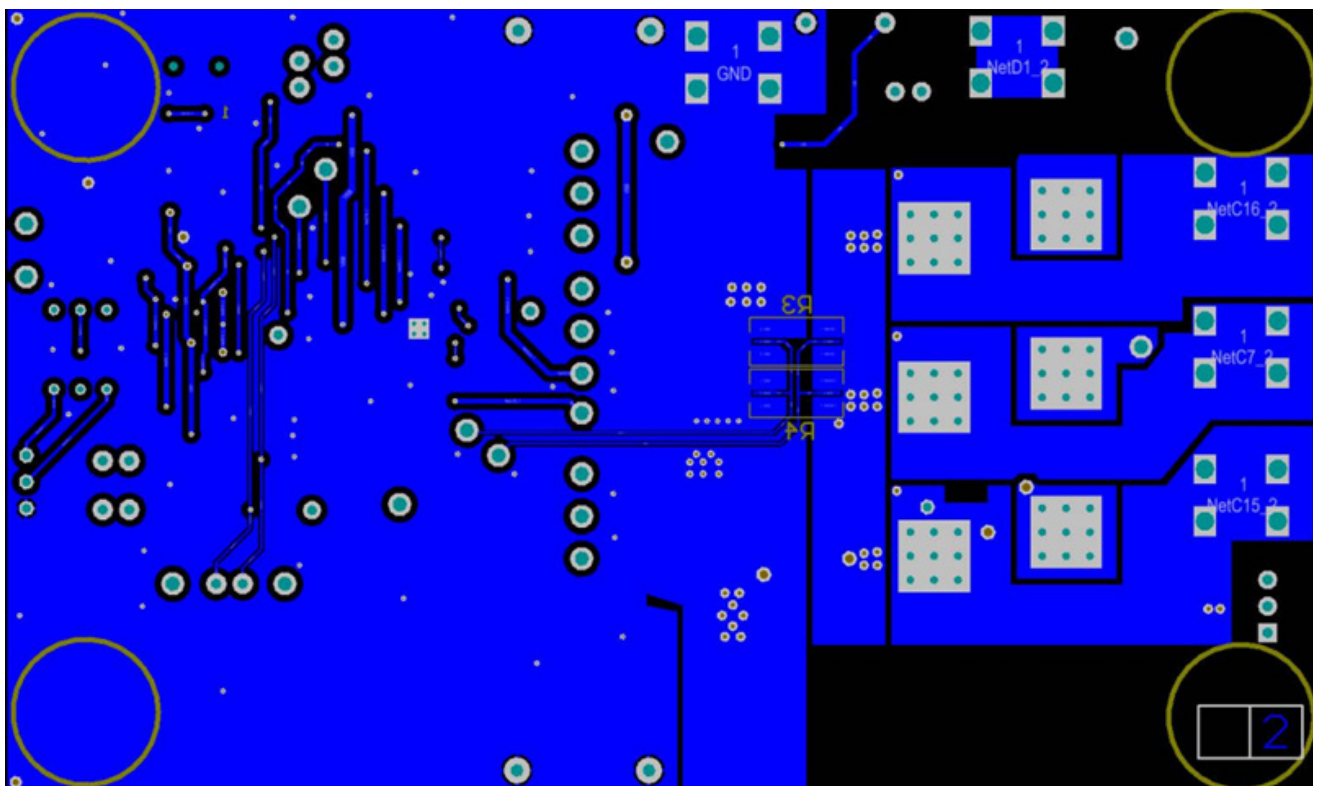
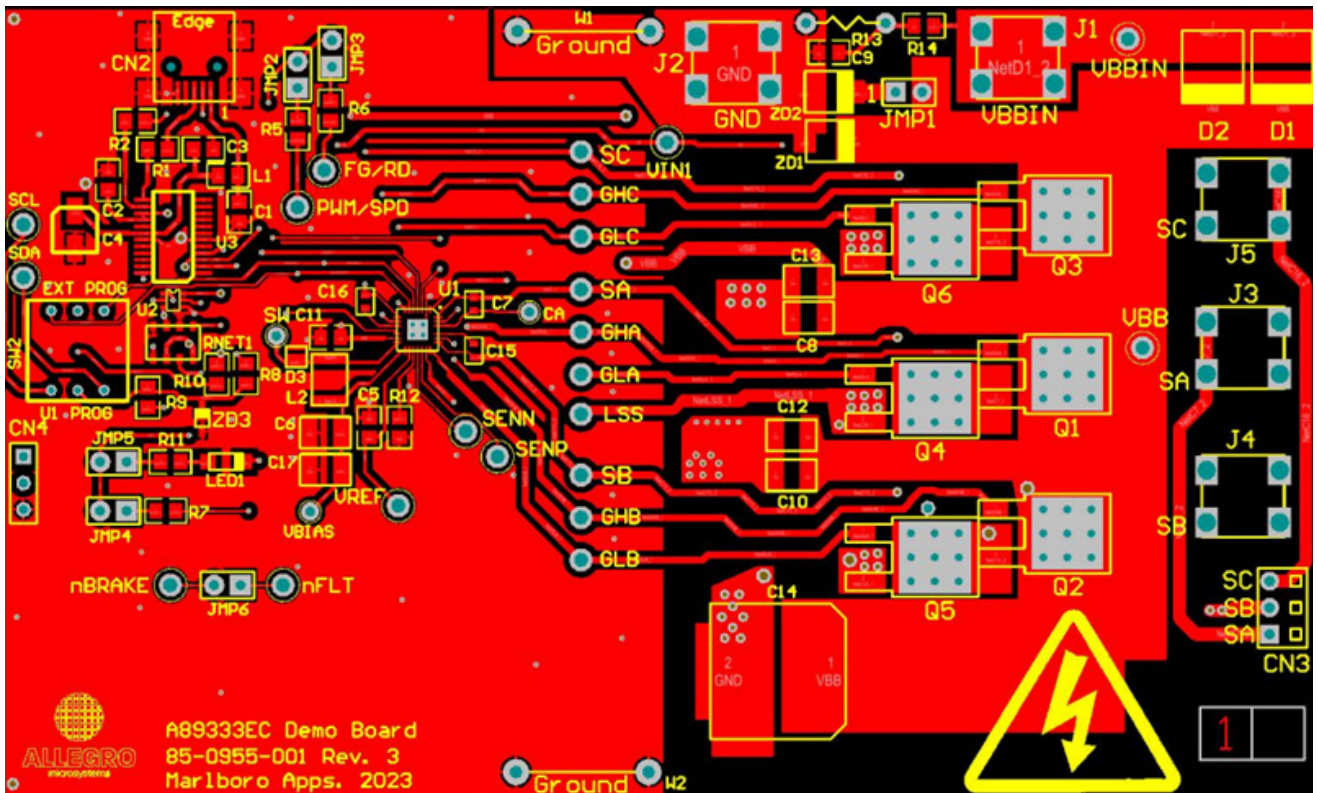

## BILL OF MATERIALS

Quantity	Designator	Value	Description	PartType	Footprint
1	C1	0.01 µF	50 V Capacitor	Yageo CC0805KRX7R9BB103; Digikey 311-1136-1-ND	0805
2	C2, C3	0.1 µF	50 V Capacitor	TDK CEU4J2X7R1H104K125AE; Digikey 445-7856-1-ND	0805
1	C4	4.7 µF	35 V Capacitor	Chemi-Con EMZA350ADA4R7MD61G; Digikey 565-2553-1-ND	UCC D61 Cap
1	C5	4.7 µF	10 V Capacitor	Samsung CL21B475KPFNNNE; Digikey 1276-2972-1-ND	0805
1	C6	10 µF	75 V Ceramic Capacitor	TDK C3225X7R1N106K250AC; Digikey 445-C3225X7R1N106K250ACCT-ND	1210
3	C7, C15, C16	0.22 µF	50 V Ceramic Capacitor	Taiyo Yuden UMK107B7224KA-TR; Digikey 587-5958-1-ND	0603
4	C8, C10, C12, C13	10 µF	100 V Capacitor	Murata GRM32EC72A106KE05L; Digikey 490-16266-1-ND	1210
1	C9	0.1 µF	100 V Capacitor	TDK CGA4J2X7R2A104K125AE; Digikey 445-15961-1-ND	0805
1	C11	0.47 µF	100 V Capacitor	TDK C2012X7S2A474K125AB; Digikey 445-5203-1-ND	0805
1	C14	100 µF	100 V Electrolytic Capacitor	Chemi-Con EMVY101ARA101MKE0S; Digikey 565-2511-1-ND	UCC KE0 KG5
1	C17	DNI	75 V Ceramic Capacitor	Not Installed	1210
3	CA, SW, VBIAS		Mini Test Point	Keystone 5000; Digikey 36-5000-ND	Mini Test Point
1	CN2		USB 2.0 Connector	EDAC 690-005-299-043; Digikey 151-1206-1-ND	EDAC 690-005-299-043
1	CN3		Molex 3-Pin Vertical Receptacle	Molex 0022022035; Digikey WM3201-ND	Molex 3-Pin 4455-N Vertical
15 Pins	CN4, JMP1, JMP2, JMP3, JMP4, JMP5, JMP6		Cut from 50-Pin Strip	Samtec TSW-150-07-T-S; Digikey SAM1035-50-ND	3-Pin 0.1" Connector, 2-Pos. Shunt
2	D1, D2		100 V/8 A Schottky Diode	Microsemi HSM8100JE3/TR13; Digikey HSM8100JE3/TR13CT-ND	DO-214AB
1	D3		100 V/1 A Schottky Diode	Diodes Inc. SDM1100LP-7; Digikey SDM1100LP-7DICT-ND	U-DFN2020-2 (Type B)
22	FG/RD, GHA, GHB, GHC, GLA, GLB, GLC, LSS, nBRAKE, nFLT, PWM/SPD, SA, SB, SC, SCL, SDA, SENN, SENP, VBB, VBBIN, VIN1, VREF		Large Test Point	Keystone 5010; Digikey 36-5010-ND	PAD 57 125 TP HB
4			Bumpon Foot	3M SJ-5303 (CLEAR); Digikey SJ5303-7-ND	Bumpon Foot
1	J1		Red Screw Connector Terminal	Keystone 7701-2; Digikey 36-7701-2-ND	Keystone 7701
1	J2		Black Screw Connector Terminal	Keystone 7701-3; Digikey 36-7701-3-ND	Keystone 7701
3	J3, J4, J5		Screw Connector Terminal	Keystone 7701; Digikey 36-7701-ND	Keystone 7701 Bottom-Only
1	L1		Ferrite Bead	Laird MI0805K400R-10; Digikey 240-2389-1-ND	0805
1	L2	10 µH	670 mA Inductor	Coilcraft PFL4514-103MEC; Mouser 994-PFL4514-103MEC	Coilcraft PFL4514
1	LED1		Red Surface-Mount LED	Lite-On LTST-C150CKT; Digikey 160-1167-1-ND	1206 LED
1			PCB	85-0955-001 Rev. 2	
6	Q1, Q2, Q3, Q4, Q5, Q6		100 V 15 A N-FET	Taiwan Semi TSM900N10CP ROG; Digikey TSM900N10CPROGCT-ND	D-PAK, TO-252
2 Pins	QR13		Sockets for R13	Mill-Max 801-43-050-10-001000; Digikey ED6350-ND	
2	R1, R2	27 Ω	1/8W Resistor	Vishay-Dale CRCW080527R0FKEA; Digikey 541-27.0CCT-ND	0805
2	R3, R4	0.05 Ω	2W Sense Resistor with Kelvin Connections	Ohmite MCS3264R050FER; Digikey MCS3264R050FERCT-ND	2512 - Sense
3	R5, R6, R7	4.99 kΩ	1/8W Resistor	Panasonic ERJ-6ENF4991V; Digikey P4.99KCT-ND	0805
3	R8, R9, R10	200 Ω	1/8W Resistor	Panasonic ERJ-6GEYJ201V; Digikey P200ACT-ND	0805
1	R11	787 Ω	1/8W Resistor	Panasonic ERJ-6ENF7870 V; Digikey P787CCT-ND	0805
1	R12	25 kΩ	1/10W Resistor	TE Connectivity CPF-A-0805B25KE; Digikey A124124CT-ND	0805
1	R13	10 kΩ	1/4W Resistor	Stackpole RNF14FTD10K0; Digikey RNF14FTD10K0CT-ND	0.3" Resistor
1	R14	10 kΩ	1/8W Resistor	Stackpole RMCF0805FT10K0; Digikey RMCF0805FT10K0CT-ND	0805
1	RNET1	10 kΩ	4 Isolated Resistors	Yageo YC324-JK-0710KL; Digikey YC324J-10KCT-ND	CTS 744 Series
1	SW2		Dual SPDT Switch	Grayhill 76STC02T; Digikey GH7720-ND	76STC02T
1	U1		BLDC Motor Controller	A89333EC	28-Pin EC_wo11+25
1	U2		Dual N-CH Fet's	Toshiba Semi SSM6N15AFU,LF; Digikey SSM6N15AFULFCT-ND	SOT-363
1	U3		USB 8-Bit FIFO IC	FTDI FT240XS-R; Digikey 768-1127-1-ND	SSOP-24 (150 mm)
2	W1, W2		22 Gauge Buss Wire (300 mm above PCB)		Scope Ground
1	ZD1	70 V	TVS Zener	Littelfuse SMBJ70A; Digikey SMBJ70ALFCT-ND	DO-214AA
1	ZD2	48 V	TVS Zener	Bourns SMBJ48A; Digikey SMBJ48ABCT-ND	DO-214AA
1	ZD3	4.7 V	Zener Diode	Diodes Inc. BZT52C4V7S-7-F; Digikey BZT52C4V7S-FDICT-ND	

---

## RELATED LINKS

A89333 product page available at: <https://www.allegromicro.com/en/products/motor-drivers/bldc-drivers/a89333>

APEK89333 GUI available from: <https://registration.allegromicro.com/login>

---

## Revision History

Number	Date	Description
–	April 3, 2024	Initial release
1	July 18, 2024	Corrected evaluation board part number (page 1), updated quick startup tips (page 12), modified frequency resolution equation (page 13), and added DC information to the Tuning Align PI Controllers section (page 19), replaced soft-off deceleration figure image with higher resolution image (page 38), and updated GUI advance tab (page 39) and UCC curves (page 40).

Copyright 2024, Allegro MicroSystems.

Allegro MicroSystems reserves the right to make, from time to time, such departures from the detail specifications as may be required to permit improvements in the performance, reliability, or manufacturability of its products. Before placing an order, the user is cautioned to verify that the information being relied upon is current.

Allegro's products are not to be used in any devices or systems, including but not limited to life support devices or systems, in which a failure of Allegro's product can reasonably be expected to cause bodily harm.

The information included herein is believed to be accurate and reliable. However, Allegro MicroSystems assumes no responsibility for its use; nor for any infringement of patents or other rights of third parties which may result from its use.

Copies of this document are considered uncontrolled documents.



# Mouser Electronics

Authorized Distributor

Click to View Pricing, Inventory, Delivery & Lifecycle Information:

[Allegro MicroSystems:](#)

[APEK89333GEC-01-T](#)