

Wireless LAN + Bluetooth[®] Module

WK8887AA1

Data Report

By purchase of any of products described in this document, the customer is deemed to understand and accept contents of this document.

The Bluetooth[®] word mark and logos are owned by the Bluetooth SIG, Inc. and any use of such marks by KAGA FEI Co., Ltd. is under license.

ATTENTION: This module requires device drivers that are under Japan export control. Depending on the customer's country and application (e.g. weapons), KAGA FEI may not be able to provide these drivers to all customers. Please contact your local KAGA FEI sales office for additional information.

To contact your local sales office and for additional product information, please visit www.kagafei.com/jp/eng/

Contents

1.Document constituent list	4
2.General Items	5
2.1. Scope	5
2.2. Description	5
3. Absolute maximum ratings	22
3.1 Absolute maximum ratings	22
3.2. Recommendation operating range	22
4. Electrical characteristics.....	23
4.1. DC Specifications	23
4.1.1. Power consumption	23
4.1.2.Digital Pad Ratings (SDIO, PCM, GPIO).....	23
4.2. AC Specifications.....	24
4.2.1.Power-on timing / External sleep clock.....	24
4.2.2. External power down(PDn).....	24
4.2.3. SDIO Interface Specifications.....	25
4.2.4. SDIO Interface Specifications.....	26
4.2.5. PCM Interface	27
4.3. RF Specifications.....	28
4.3.1. WLAN 2.4GHz Band	28
4.3.2. WLAN 5GHz Band	28
4.3.3. Bluetooth®	28
5. Circuit Schematic	29
5.1. Block Diagram	29
5.2. Example of peripheral circuit schematics.....	30
6. Outline/Appearance.....	31
6.1. OUTLINE	31
6.2. Module Pad Dimension	32
6.3. Recommended Land Pattern Dimension	33
6.4. Recommended Metal Mask (Solder Mask) Conditions.....	33
6.5. Marking Information.....	34
7.Pin Layout.....	35
8. Handling Precaution	38
8.1.Desire/Conditions	38
9. Packaging Specification	40
10. Antenna Application Note	43
Precautions.....	47

1.Document constituent list

Control name	Control No.	Document Page
General Items	KM-AG-A223020	<u>1/17 – 17/17</u>
Absolute maximum ratings	KM-AM-A223020	<u>1/1</u>
Electrical characteristics	KM-AE-A223020	<u>1/6 - 6/6</u>
Circuit schematic	KM-MC-A223020	<u>1/2 – 2/2</u>
Outline / Appearance	KM-AD-A223020	<u>1/4 - 4/4</u>
Pin Layout	KM-BA-A223020	<u>1/3 - 3/3</u>
Handling Precaution	MQ-H-001	<u>1/2 - 2/2</u>
Packaging Specification	KM-BB-A223020	<u>1/3 - 3/3</u>
Antenna Application Note	-	<u>1/4 - 4/4</u>
Precautions	MQ-P-001	<u>1/1</u>

Rev. records

7-Apr.2023> Rev1.0 Release

Control No. KM-AG-A223020	(1/17)	Control name General Items
------------------------------	--------	-------------------------------

2. General Items

2.1. Scope

This specification ("Specification") applies to the hybrid IC "WK8887AA1", Wireless LAN and Bluetooth® module ("Product") manufactured by KAGA FEI Co., Ltd. ("KAGA FEI ")

2.2. Description

- ① User Code : WK8887AA1
Model : WK8887

Note : Please let us know the Part number (WK8887AA1) to order this product.

- ② Chip : NXP 88W8887
- ③ Function : Radio frequency transceiver Module.
(IEEE802.11ac/a/b/g/n and Bluetooth®4.2 conformity)
- ④ Application : Portable audio/ video device, wireless home audio/video entertainment, handy terminal
- ⑤ Structure : Hybrid IC loaded with silicon and Gallium arsenide compound monolithic semiconductor.
Regarding the containment of hazardous substance in this Product, it conforms to RoHS Directive.

Ability of lead free mounting at customer's assembly
(Heat resistance of this Product) : Yes
- ⑥ Outline : 56pin leadless chip carrier
- ⑦ Marking : Part Number, Lot Number, manufacturer and Japan ID, FCC ID, ISED ID Number on Shielding Case
- ⑧ Features :
- IEEE802.11ac/a/b/g/n and Bluetooth®4.2 standard
 - Interface: SDIO3.0, PCM
 - Embedded MPU for reducing loads on host processor
- ⑨ Security : TKIP, WEP, AES, CCMP, CMAC, WAPI, WPA/WPA2(64bit/128bit)
- ⑩ Country of origin : Japan or Thailand
- ⑪ Packing : Packaging method : Tray
Packaging unit : 48 pieces/Tray, 480pieces/Box
Standard order quantity : 960 pcs multiples
- ⑫ Mount : SMD Type

Control No. KM-AG-A223020	(2/17)	Control name General Items
------------------------------	--------	-------------------------------

⑬ Notes :

a. Limitation of Warranty

i) KAGA FEI provide warranties only if the product is operated under the condition set forth in this specification. Please note that KAGA FEI shall not be liable for any defect and/or malfunction arising from use of the product under the terms and conditions other than the operating conditions hereof. In addition, when this product is used under environmental conditions such as over voltage which is not guaranteed, it may be destroyed in short mode. To ensure the security of customer's product, please add an extra fuse or/and a protection circuit for over voltage.

ii) In some cases, KAGA FEI may use replacements as component parts of products. Such replacement shall apply only to component part of products, which KAGA FEI deems it possible to replace or substitute according to (i) scope of warranty provided in this specification (e.g. electric characteristics, outline, dimension, conditions of use, reliability tests, official standard (type approvals etc.)) and (ii) quality of products. KAGA FEI also ensures traceability of such replacement on production lot basis.

b. Instruction for Use (CAUTION)

i) Because product is not designed for radiation durability, please refrain from exposing product to radiation in the use.

ii) Communication between this product and other might not be established nor maintained depending upon radio environment or operating condition of this product and other products with wireless technology.

iii) This product operates in the unlicensed ISM band at 2.4GHz/5GHz. In case this product is used around the other wireless devices which operate in same frequency band of this product, there is a possibility that interference occurs between this product and such other devices. If such interference occurs, please stop the operation of other devices or relocate this product before using this product or do not use this product around the other wireless devices.

iv) WK8887AA1 is qualified with Component(Tested) category by Bluetooth SIG. The QDID of this module is 118078. The final product needs to get qualification as End product before selling the product. Please contact your Qualification body for details on Qualification.

c. Term of Support

i) In the case that customer requests KAGA FEI to customize the hardware of this Product in order to meet such customer's specific needs, KAGA FEI will make commercially reasonable effort to modify such hardware or software at customer's expense; provide however, the customer is kindly requested to agrees it doesn't mean that KAGA FEI has obligations to do so even in the case it is technically difficult for KAGA FEI.

ii) Any failure arising out of this Product will be examined by KAGA FEI regardless of before or after mass production. Customer agrees that once such failure is turned out not to be responsible for KAGA FEI after aforesaid examination, some of the technical support shall be conducted by KAGA FEI at customer's expense; provided however, exact cost of this technical support can be agreed through the negotiation by the parties.

Control No. KM-AG-A223020	(3/17)	Control name General Items
------------------------------	--------	-------------------------------

- iii) Do not alter hardware and/or software of this Product. Please note that KAGA FEI shall not be liable for any problem if it is caused by customer's alteration of Hardware without KAGA FEI 's prior approvals.
- iv) KAGA FEI does not guarantee functions and performances which depend on the customer's firmware. KAGA FEI does not assume liabilities for defects and failures (i) in functions, performances and quality of the Customer's product incorporating the Products and (ii) which may occur as the Product is incorporated in the Customer's product.
- d. Term of Warranty
KAGA FEI warrants only that this Product is in conformity with this Specification for one year after purchase and shall in no event give any other warranty.
- e. Items of the Specification
Any question arising from the Specification shall be solved in good faith through mutual discussion by the parties hereof.
- f. Caution for Export Control
This Product may be subject to governmental approvals, consents, licenses, authorizations, declarations, filings, and registrations for export or re-export as required by Japanese Foreign Exchange and Foreign Trade Law (including related laws and regulations) and/or any other country's applicable laws or regulations related to export control.
If this Product will be exported or re-exported, it is strongly recommended that customers check and confirm the necessary procedures to export or re-export this Product as required by applicable laws and regulations, and if necessary, customers must obtain the necessary and appropriate approvals or licenses from governmental authority at their own risk and expense.

Control No. KM-AG-A223020	(4/17)	Control name General Items
------------------------------	--------	-------------------------------

⑭ Japan Regulatory Information

This module is approved with the specific antenna on this module. Please ensure that your product can also bear a label with the following information. If the product is so small that it is not practicable to place the label, you can also place it in the instruction manual and package. The mark diameter shall be easily legible without using a device such as light microscopes.

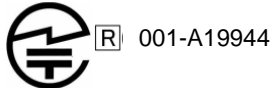

It is recommended to include the following sentence in the user manual of your product:
This product installs a radio system which has been approved as a radio station in a low power data communication system based on the Radio Law.

WK8887 : 001-A19944

Region is set to US as default and 12ch(2467MHz) and 13ch(2472MHz) are disabled.
Please change the region setting to Japan, if it is needed to use these channels on the final product.

⑮ Canada Regulatory Information

a). Product Information.

HVIN: WK8887, PMN: WK8887

FVIN: 15.2.7.123

b). This device contains license-exempt transmitter(s)/receiver(s) that comply with Innovation, Science and Economic Development Canada's license-exempt RSS(s). Operation is subject to the following two conditions:

1. This device may not cause interference.
2. This device must accept any interference, including interference that may cause undesired operation of the device.

Le présent appareil est conforme aux CNR Innovation, Sciences et Développement économique Canada applicables aux appareils radio exempts de licence. L'exploitation est autorisée aux deux conditions suivantes:

1. l'appareil ne doit pas produire de brouillage;
2. l'utilisateur de l'appareil doit accepter tout brouillage radioélectrique subi, même si le brouillage est susceptible d'en compromettre le fonctionnement.

Control No. KM-AG-A223020	(5/17)	Control name General Items
------------------------------	--------	-------------------------------

- c). This equipment complies with ISED radiation exposure limits set forth for an uncontrolled environment and meets RSS-102 of the ISED radio frequency (RF) Exposure rules. This equipment should be installed and operated keeping the radiator at least 20cm or more away from person's body.

Cet équipement est conforme aux limites d'exposition aux rayonnements énoncées pour un environnement non contrôlé et respecte les règles d'exposition aux fréquences radioé lectriques (RF) CNR-102 de l'ISED. Cet équipement doit être installé et utilisé en gardant une distance de 20 cm ou plus entre le radiateur et le corps humain.

- d). Please notify certified ID by either one of the following method on your product.

Specifiez ID certifiée dans votre produit par une de méthode suivante.

- Contains Transmitter module IC : 28568-WK8887
- Contains IC : 28568-WK8887

- e). Please indicate your product name at any location on the exterior of the host product or product packaging or product literature, which shall be available with the host product or online.

- f). This product is certified under the conditions of using channels 1(2412MHz) to 11(2462MHz). Please set the region as CANADA or other which uses channels from 1 to 11. If channels 12(2467MHz) or 13(2472MHz) are used, it may violate the radio regulations.

Ce produit est certifié pour une utilisation sur les canaux 1 (2412MHz) à 11 (2462MHz). Veuillez choisir la région CANADA ou toute autre région utilisant uniquement ces canaux. L'utilisation sur les canaux 12 (2467MHz) ou 13 (2472MHz) peut constituer une violation des r èglements sur les radiocommunications.

- g). The device for operation in the bands 5150–5250 MHz and 5250-5350MHz are only for indoor use to reduce the potential for harmful interference to co-channel mobile satellite systems.

Ce produit dont la fréquence de fonctionnement se situe entre 5150-5250MHz et 5250-5350MHz est conçue uniquement pour une utilisation en intérieur afin de réduire les risques d'interférences nuisibles avec les systèmes mobiles par satellite à deux canaux.

Control No. KM-AG-A223020	(6/17)	Control name General Items
------------------------------	--------	-------------------------------

- h). Please inform your users that high-power radars are allocated as primary users (i.e. priority users) of the bands 5250-5350 MHz and 5650-5850 MHz and that these radars could cause interference and/or damage to LE-LAN devices.

Veillez informer vos utilisateurs que les radars à haute puissance sont désignés comme utilisateurs principaux (c-à-d des utilisateurs prioritaires) des fréquences 5250-5350 MHz et 5650-5850 MHz et que ces radars pourraient provoquer des interférences et / ou endommager les appareils.

- i). This product shall not be capable of transmitting in the band 5600-5650MHz.

Ce produit ne doit pas être capable de transmettre entre les fréquences 5600-5650MHz.

- j). The device driver/firmware for this product is downloaded from a limited access web site provided by the device manufacturer and is implemented specifically for this product. The ID/password required to access the web site can be obtained after the conclusion of a contract with the device manufacturer.

Le pilote/micrologiciel du dispositif pour ce produit est téléchargé à partir d'un site internet à accès limité fourni par le fabricant de l'appareil et est mis en œuvre spécifiquement pour ce produit. L'identifiant / mot de passe requis pour accéder au site internet peut être obtenu après la conclusion d'un contrat avec le fabricant du périphérique.

- k). Please use the specified supply voltage in "Recommendation operating range" when installing this product. The final products must contain a power supply regulator and must ensure the applied voltage to this product is adjusted to always be within the operating voltage range.

Veillez utiliser la tension d'alimentation précisée dans « Recommandation gamme opératoire » lorsque vous installez ce produit. Les produits finaux doivent contenir un régulateur de la source de courant et doivent garantir que le voltage appliqué à ce produit soit ajusté de sorte à être toujours à l'intérieur de la gamme de voltage en opération.

Control No. KM-AG-A223020	(7/17)	Control name General Items
------------------------------	--------	-------------------------------

- l). Data transmission is always initiated by software, which is then passed down through the MAC, through the digital and analog baseband, and finally to the RF chip. Several special packets are initiated by the MAC. These are the only ways the digital baseband portion will turn on the RF transmitter, which it then turns off at the end of the packet. Therefore, the transmitter will be on only while one of the aforementioned packets is being transmitted. In other words, this device automatically discontinues transmission in case of either absence of information to transmit or operational failure.

La transmission des données est toujours initiée par le logiciel, puis les données sont transmises par l'intermédiaire du MAC, par la bande de base numérique et analogique et, enfin, à la puce RF. Plusieurs paquets spéciaux sont initiés par le MAC. Ce sont les seuls moyens pour qu'une partie de la bande de base numérique active l'émetteur RF, puis désactive celui-ci à la fin du paquet. En conséquence, l'émetteur reste uniquement activé lors de la transmission d'un des paquets susmentionnés. En d'autres termes, ce dispositif interrompt automatiquement toute transmission en cas d'absence d'information à transmettre ou de défaillance.

- m). Any changes or modifications not expressly approved by the party responsible for compliance could void the user's authority to operate the equipment.
- n). This product is authorized under the following conditions in USA and Canada. Please do not use this equipment outside the approval range.

Ce produit est autorisé dans les conditions suivantes les États-Unis et du Canada. S'il vous plaît ne pas utiliser en dehors de la plage d'approbation.

5180 – 5240 MHz : Master / Client device
5260 – 5320 MHz : Client device
5500 – 5700 MHz : Client device
5745 – 5825 MHz : Master / Client device

5180 – 5240 MHz : Maître / Client appareil
5260 – 5320 MHz : Client appareil
5500 – 5700 MHz : Client appareil
5745 – 5825 MHz : Maître / Client appareil

Control No. KM-AG-A223020	(8/17)	Control name General Items
------------------------------	--------	-------------------------------

o). The following channels are available for this equipment:

For 2402-2480MHz (Bluetooth BDR/EDR, Bluetooth Low Energy)

79 channels are provided for Bluetooth BDR/EDR: 0–78ch

40 channels are provided for Bluetooth Low Energy: 0–39ch

For 2412-2462MHz (IEEE802.11b/g/n-20)

11 channels are provided for 802.11b/g/n(HT20): 1-11ch

For 2422-2452MHz (IEEE802.11n-40)

7 channels are provided for 802.11n(HT40): 3-9ch

For 5180-5240MHz

4 channels are provided for 802.11a, 802.11n(HT20), 802.11ac(VHT20): 36ch, 40ch, 44ch, 48ch

2 channels are provided for 802.11n(HT40), 802.11ac(VHT40): 38ch, 46ch

1 channel is provided for 802.11ac(VHT80): 42ch

For 5260-5320MHz

4 channels are provided for 802.11a, 802.11n(HT20), 802.11ac(VHT20): 52ch, 56ch, 60ch, 64ch

2 channels are provided for 802.11n(HT40), 802.11ac(VHT40): 54ch, 62ch

1 channel is provided for 802.11ac(VHT80): 58ch

For 5500-5700MHz

8 channels are provided for 802.11a, 802.11n(HT20), 802.11ac(VHT20): 100ch, 104ch, 108ch, 112ch, 116ch, 132ch, 136ch, 140ch

3 channels are provided for 802.11n(HT40), 802.11ac(VHT40): 102ch, 110ch, 134ch

1 channels are provided for 802.11ac(VHT80): 106ch

For 5745-5825MHz

5 channels are provided for 802.11a, 802.11n(HT20), 802.11ac(VHT20): 149ch, 153ch, 157ch, 161ch, 165ch

2 channels are provided for 802.11n(HT40), 802.11ac(VHT40): 151ch, 159ch

1 channel is provided for 802.11ac(VHT80): 155ch

p). The antenna used for this transmitter must not be co-located or operating in conjunction with any other antenna or transmitter.

L'antenne utilisée pour cet émetteur ne doit pas être co-localisée ou fonctionner conjointement avec une autre antenne ou un autre émetteur.

Control No. KM-AG-A223020	(9/17)	Control name General Items
------------------------------	--------	-------------------------------

- q). Please inform your users that under Innovation, Science and Economic Development Canada (ISED) regulations, this radio transmitter may only operate using an antenna of a model and maximum (or lesser) gain approved for the transmitter by ISED. To reduce potential radio interference to other users, the antenna type and its gain should be so chosen that the equivalent isotropically radiated power (e.i.r.p.) is not more than that necessary for successful communication.

Veuillez informer vos utilisateurs que En vertu des règlements d'Innovation, Sciences et Développement économique Canada, cet émetteur radio ne peut fonctionner qu'avec une antenne d'un modèle et d'un gain maximal (ou inférieur) approuvé pour l'émetteur par Innovation, Sciences et Développement économique Canada. Pour réduire la probabilité d'interférence avec d'autres utilisateurs, le type d'antenne et son gain doivent être choisis pour que la puissance isotrope rayonnée équivalente (e.i.r.p.) soit supérieure à celle nécessaire pour une communication réussie.

- r). This radio transmitter (28568-WK8887) has been approved by Innovation, Science and Economic Development Canada to operate with the antenna model listed below, with the maximum permissible gain indicated. Antenna model not included in this list that have a gain greater than the maximum gain indicated for any model listed are strictly prohibited for use with this device.

To reduce potential radio interference to other users, the antenna model and its gain should be so chosen that the equivalent isotropically radiated power (e.i.r.p.) is not more than that necessary for successful communication.

Manufacturer	TAIYO YUDEN
Part No.	AH104N2450D1
Antenna Type	Monopole
Maximum Antenna Gain	2.1dBi (2402 – 2480MHz) 2.4dBi (5180 – 5825MHz)

Le présent émetteur radio (28568-WK8887) a été approuvé par Innovation, Sciences et Développement économique Canada pour fonctionner avec les modèle d'antenne énumérés ci-dessous et ayant un gain admissible maximal. Les modèle d'antenne non inclus dans cette liste, et dont le gain est supérieur au gain maximal indiqué pour tout modèle figurant sur la liste, sont strictement interdits pour l'exploitation de l'émetteur. De réduire les interférences potentielles avec les autres utilisateurs, il est nécessaire de choisir le type d'antenne et le gain ne dépassant pas (e.i.r.p.) accepté pour une communication normale.

Fabricant	TAIYO YUDEN
Numéro d'article	AH104N2450D1
Type d'antenne	Monopole
Maximum Gain de l'antenne	2.1dBi (2402 – 2480MHz) 2.4dBi (5180 – 5825MHz)

Control No. KM-AG-A223020	(10/17)	Control name General Items
------------------------------	---------	-------------------------------

- s). Please include the following statements in rectangle on the user manual of the host device of this module;

This device contains license-exempt transmitter(s)/receiver(s) that comply with Innovation, Science and Economic Development Canada's license-exempt RSS(s). Operation is subject to the following two conditions:

- (1) This device may not cause interference.
- (2) This device must accept any interference, including interference that may cause undesired operation of the device.

Ce appareil contient émetteur(s) / récepteur(s) d'exemption de licence, et il est conforme aux CNR d'Innovation, Sciences et Développement économique Canada applicables aux appareils radio exempts de licence. L'exploitation est autorisée aux deux conditions suivantes :

- 1) l'appareil ne doit pas produire de brouillage.
- 2) l'utilisateur de l'appareil doit accepter tout brouillage radioélectrique subi, même si le brouillage est susceptible d'en compromettre le fonctionnement.

The device for operation in the bands 5150–5250 MHz and 5250-5350MHz are only for indoor use to reduce the potential for harmful interference to co-channel mobile satellite systems.

Ce produit dont la fréquence de fonctionnement se situe entre 5150-5250MHz et 5250-5350MHz est conçue uniquement pour une utilisation en intérieur afin de réduire les risques d'interférences nuisibles avec les systèmes mobiles par satellite à deux canaux.

Data transmission is always initiated by software, which is the passed down through the MAC, through the digital and analog baseband, and finally to the RF chip. Several special packets are initiated by the MAC. These are the only ways the digital baseband portion will turn on the RF transmitter, which it then turns off at the end of the packet. Therefore, the transmitter will be on only while one of the aforementioned packets is being transmitted. In other words, this device automatically discontinues transmission in case of either absence of information to transmit or operational failure.

La transmission des données est toujours initiée par le logiciel, puis les données sont transmises par l'intermédiaire du MAC, par la bande de base numérique et analogique et, enfin, à la puce RF. Plusieurs paquets spéciaux sont initiés par le MAC. Ce sont les seuls moyens pour qu'une partie de la bande de base numérique active l'émetteur RF, puis désactive celui-ci à la fin du paquet. En conséquence, l'émetteur reste uniquement activé lors de la transmission d'un des paquets susmentionnés. En d'autres termes, ce dispositif interrompt automatiquement toute transmission en cas d'absence d'information à transmettre ou de défaillance.

Control No. KM-AG-A223020	(11/17)	Control name General Items
------------------------------	---------	-------------------------------

This equipment complies with ISED radiation exposure limits set forth for an uncontrolled environment and meets RSS-102 of the IC radio frequency (RF) Exposure rules. This equipment should be installed and operated keeping the radiator at least 20cm or more away from person's body.

Cet équipement est conforme aux limites d'exposition aux rayonnements énoncées pour un environnement non contrôlé et respecte les règles d'exposition aux fréquences radioélectriques (RF) CNR-102 de l'ISED. Cet équipement doit être installé et utilisé en gardant une distance de 20 cm ou plus entre le dispositif rayonnant et le corps humain.

⑩ FCC Regulatory Information

- a). This device complies with below part 15 of the FCC Rules.
Part 15 Subpart C
Part 15 Subpart E
- b). This device complies with part 15 of the FCC Rules. Operation is subject to the following two conditions: (1) This device may not cause harmful interference, and (2) this device must accept any interference received, including interference that may cause undesired operation.
- c). This equipment complies with FCC radiation exposure limits set forth for an uncontrolled environment and meets the FCC radio frequency (RF) Exposure Guidelines. This equipment should be installed and operated keeping the radiator at least 20cm or more away from person's body.
- d). Please use the specified supply voltage in "Recommendation operating range" when installing this product. The final products must contain a power supply regulator and must ensure the applied voltage to this product is adjusted to always be within the operating voltage range.
- e). Please notify certified ID by either one of the following method.

-Contains Transmitter Module FCC ID: 2A6NFWK8887
-Contains FCC ID: 2A6NFWK8887
- f). CAUTION: changes or modifications not expressly approved by the party responsible for compliance could void the user's authority to operate the equipment.
- g). This module can change the output power depending on the circumstances by the application software which is developed by module installer. Any end user cannot change the output power.
- h). This product is certified under the condition of using 1(2412MHz) to 11(2462MHz) channels. Region is set to US as default and 1 to 11 channels are used. Please set the region as default (US) and do not change. If 12(2467MHz) or 13(2472MHz) channels are used, it may violate the radio regulations.

Control No. KM-AG-A223020	(12/17)	Control name General Items
------------------------------	---------	-------------------------------

- i). This product is FCC approved only as a module. Manufacturers of final devices has a responsibility for the conditions which are not approved as a module. Please carry out the tests of FCC Part 15 Subpart B in case your final device installs this module.
- j). Co-location of this module with other transmitters that operate simultaneously are required to be evaluated using the FCC multi transmitter procedures. When installing this module to your final devices, please make sure to carry out all the necessary evaluations according to the applicable guidelines like follows:
-for RF exposure: KDB 447498, KDB 996369 and any other relevant guidelines
-for EMC: KDB 996369 D04 and any other relevant guidelines
- k). When you install this module to your final devices, please ensure that your final composite product complies with the applicable FCC rules in reference to a guidance in KDB 996369.
- l). When you install this module to your final devices, please ensure to perform all the required equipment authorization and testing for the technical parameters which are not covered by the module grant (e.g., unintentional radiator Part 15 Subpart B requirements, or transmitters used in the host which are not previously approved as modules).
- m). Data transmission is inevitably initiated by software of host devices with the exception that several special packets are transmitted by the MAC. However, data transmission is terminated by end of packets in any cases. Therefore, it is RF transmitted only while packets are being transmitted. This modular transmitter automatically discontinues transmission in case of either absence of information to transmit or operational failure because RF parts will not be ON in neither cases.
- n). The device driver/firmware for this product is downloaded from a limited access web site provided by the device manufacturer and is implemented specifically for this product. The ID/password required to access the web site can be obtained after the conclusion of a contract with the device manufacturer.
- o). Frequency Tolerance
2.4GHz Band :±25 ppm, 5GHz Band :±20 ppm
- p). The antenna used for this transmitter must not be co-located or operating in conjunction with any other antenna or transmitter.
- q). Antenna List
This module is approved along with the following antennas.
You cannot use any antennas other than the listed ones because it deviates from the accredited conditions.

Manufacturer	TAIYO YUDEN
Part No.	AH104N2450D1
Antenna Type	Monopole
Maximum Antenna Gain	2.1dBi (2402 – 2480MHz) 2.4dBi (5180 – 5825MHz)

- r). To maintain compliance with FCC’s RF exposure guidelines, use only the supplied antenna. Unauthorized antenna, modification, or attachments could damage the transmitter and may violate FCC regulations.

Control No. KM-AG-A223020	(13/17)	Control name General Items
------------------------------	---------	-------------------------------

- s). This product is authorized under the following conditions in USA and Canada.
Please do not use this equipment outside the approval range.

5180 – 5240 MHz : Master / Client device
5260 – 5320 MHz : Client device
5500 – 5700 MHz : Client device
5745 – 5825 MHz : Master / Client device

The following channels are available for this equipment:

For 2402-2480MHz (Bluetooth BDR/EDR, Bluetooth Low Energy)

79 channels are provided for Bluetooth BDR/EDR : 0–78ch
40 channels are provided for Bluetooth Low Energy : 0–39ch

For 2412-2462MHz (IEEE802.11b/g/n-20)

11 channels are provided for 802.11b/g/n(HT20) : 1-11ch

For 2422-2452MHz (IEEE802.11n-40)

7 channels are provided for 802.11n(HT40) : 3-9ch

For 5180-5240MHz

4 channels are provided for 802.11a, 802.11n(HT20), 802.11ac(VHT20) : 36ch, 40ch, 44ch, 48ch
2 channels are provided for 802.11n(HT40), 802.11ac(VHT40) : 38ch, 46ch
1 channel is provided for 802.11ac(VHT80) : 42ch

For 5260-5320MHz

4 channels are provided for 802.11a, 802.11n(HT20), 802.11ac(VHT20) : 52ch, 56ch, 60ch, 64ch
2 channels are provided for 802.11n(HT40), 802.11ac(VHT40) : 54ch, 62ch
1 channel is provided for 802.11ac(VHT80) : 58ch

For 5500-5700MHz

11 channels are provided for 802.11a, 802.11n(HT20), 802.11ac(VHT20) : 100ch, 104ch, 108ch, 112ch, 116ch, 120ch, 124ch, 128ch, 132ch, 136ch, 140ch
5 channels are provided for 802.11n(HT40), 802.11ac(VHT40) : 102ch, 110ch, 118ch, 126ch, 134ch
2 channels are provided for 802.11ac(VHT80) : 106ch, 122ch

For 5745-5825MHz

5 channels are provided for 802.11a, 802.11n(HT20), 802.11ac(VHT20) : 149ch, 153ch, 157ch, 161ch, 165ch
2 channels are provided for 802.11n(HT40), 802.11ac(VHT40) : 151ch, 159ch
1 channel is provided for 802.11ac(VHT80) : 155ch

Control No. KM-AG-A223020	(14/17)	Control name General Items
------------------------------	---------	-------------------------------

- t). Please include the following statements in rectangle on the user manual of the host device of this module;

This device complies with part 15 of the FCC Rules. Operation is subject to the following two conditions:

- (1) This device may not cause harmful interference, and
- (2) this device must accept any interference received, including interference that may cause undesired operation.

FCC CAUTION: Any changes or modifications not expressly approved by the party responsible for compliance could void the use's authority to operate the equipment.

The antenna used for this transmitter must not be co-located or operating in conjunction with any other antenna or transmitter.

This equipment complies with FCC radiation exposure limits set forth for an uncontrolled environment and meets the FCC radio frequency (RF) Exposure Guidelines. This equipment should be installed and operated keeping the radiator at least 20cm or more away from person's body.

Compliance with FCC requirement 15.407(c)

Data transmission is always initiated by software, which is passed down through the MAC, through the digital and analog baseband, and finally to the RF chip. Several special packets are initiated by the MAC. These are the only ways the digital baseband portion will turn on the RF transmitter, which it then turns off at the end of the packet. Therefore, the transmitter will be on only while one of the aforementioned packets is being transmitted. In other words, this device automatically discontinues transmission in case of either absence of information to transmit or operational failure.

Frequency Tolerance: ± 25 ppm (2.4GHz)

Frequency Tolerance: ± 20 ppm (5GHz)

This device complies with below part 15 of the FCC Rules.

Part 15 Subpart C

Part 15 Subpart E

The modular transmitter is only FCC authorized for the specific rule parts (i.e., FCC transmitter rules) listed on the grant (FCC Part 15.247), and the host product manufacturer is responsible for compliance to any other FCC rules that apply to the host not covered by the modular transmitter grant of certification.

The final host product still requires Part 15 Subpart B compliance testing with the modular transmitter installed.

Control No. KM-AG-A223020	(15/17)	Control name General Items
------------------------------	---------	-------------------------------

⑰ CE Regulatory Information

- a). When your end product installs this module, it is required to proceed additional certification processes before placing on the market in EU member states to make your products fully comply with relative EU standards. Additionally, if your end product is subject to the restrictions of RE Directive, Article 10.10, it is required to display the required information in addition to the certification processes.

Referenced regulations

- Directive 2014/53/EU
- COMMISSION IMPLEMENTING REGULATION (EU) 2017/1354 of 20 July 2017 specifying how to present the information provided for in Article 10(10) of Directive 2014/53/EU of the European Parliament and of the Council

Above regulations are referenced as of the issue date of this document. Since the aforementioned regulations have possibilities to be modified and added in the future, please make sure that you should always confirm the latest regulations.

- b). Restrictions to this product (as of November, 2022):
Permissible operation outline shows as follows and, please refer to the latest Office Journal of the European Union for the detail.
- Radio LAN operating in 5.15 – 5.25 GHz:
Indoor use only, including installations inside road vehicles, trains and aircraft, and limited outdoor use.
 - Radio LAN operating in 5.25 – 5.35 GHz:
Indoor use: inside buildings only.
Installations in road vehicles, trains and aircraft are not permitted.
Outdoor use is not permitted.
 - Radio LAN operating in 5.47 – 5.725 GHz:
Indoor and outdoor use.
Installations in road vehicles are permitted only for WAS/RLANs devices operating in slave mode.
Installations in trains and aircraft and use for UAS are not permitted.

Above regulations are referenced as of the issue date of this document. Since the aforementioned regulations have possibilities to be modified and added in the future, please make sure that you should always confirm the latest regulations.

- c). KAGA FEI can provide you the test reports of conducted measurement portion for the radio module. You can utilize the test reports for the certification processes of your end product as it requires radio testing.

Control No. KM-AG-A223020	(16/17)	Control name General Items
------------------------------	---------	-------------------------------

⑱ France Regulatory Information

In addition to the CE regulatory information in the preceding paragraph, it is required to perform the following.

When using this radio module within 20cm from human body, it can be required to proceed additional testing or evaluation for Specific Absorption Rate (SAR). When performing the additional SAR test or evaluation, please indicate the SAR value on your user instructions in a legible, intelligible and visible manner if your final device is being put into service and intended to be used in France.

Referenced regulations(France)

- Order of amending the Order of 8 October 2003 on consumer information regarding radio terminal equipment issued pursuant to Article R20-10 of the Postal and Telecommunications Code, the Order of 8 October 2003 setting out the technical specifications applicable to radio terminal equipment and the Order of 12 October 2010 on displaying the specific absorption rate of radio terminal equipment
- Order of 8 October 2003 on consumer information regarding radio terminal equipment issued pursuant to Article R20-10 of the Postal and Telecommunications Code
- Order of 8 October 2003 setting out the technical specifications applicable to radio terminal equipment
- Order of 12 October 2010 on displaying the specific absorption rate of radio terminal Equipment

Above regulations are referenced as of the issue date of this document. Since the aforementioned regulations have possibilities to be modified and added in the future, please make sure that you should always confirm the latest regulations.

Control No. KM-AG-A223020	(17/17)	Control name General Items
------------------------------	---------	-------------------------------

⑱ Operating in 12ch(2467MHz) and 13ch(2472MHz) in Japan

- a). In case operating in 12ch and 13ch in JAPAN, region code for JAPAN need to be set.

In case host device of this product operates in 12ch and 13ch, do not describe items instructed to describe in FCC and ISED regulatory information in this specification on the host device or user manual. The product operates in 12ch and 13ch can be used only in Japan.

- b). This product is certified under the condition of operating in 1ch(2412MHz) to 11ch(2462MHz) for FCC and ISED regulatory, so please control this product and its operation appropriately. If this product operates in 12ch or 13ch in target country of FCC and ISED, it may violate the regulations. Please note that KAGA FEI shall not be liable in such case.
- c). RF specification for 12ch and 13ch is applied for Electrical specification (RF) in this specification.

⑳ This product is certified with the following functions in each region.

Region	Frequency Band			
	W52 (5180 – 5240 MHz)	W53 (5260 – 5320 MHz)	W56 (5500 – 5700 MHz)	W58 (5745 – 5825 MHz)
Japan	AP & STA mode	STA mode	STA mode	N/A
U.S.A./ Canada	AP & STA mode	STA mode	STA mode	AP & STA mode
EU (Conducted Test Report)	STA mode	STA mode	STA mode	N/A

[AP: Access Point, STA: Station]

Control No. KM-AM-A223020	(1/1)	Control name Absolute maximum ratings
------------------------------	-------	--

3. Absolute maximum ratings

3.1 Absolute maximum ratings

Item	Symbol	Rating			Unit	Remark
		Min.	Typ.	Max.		
Supply voltage 1	VBAT	-	3.3	4.5	V	
Supply voltage 2	VDD33	-	3.3	4.0	V	
Supply voltage 3	VIO	-	1.8	2.2	V	
		-	2.5	3.0	V	
		-	3.3	4.0	V	
Supply voltage 4	VIO_SD	-	1.8	2.2	V	
		-	3.3	4.0	V	
Supply voltage 5	VIO_RF	-	3.3	4.0	V	

3.2. Recommendation operating range

Item	Symbol	Rating			Unit	Remark
		Min.	Typ.	Max.		
Supply voltage 1	VBAT	2.7	3.3	4.5	V	
Supply voltage 2	VDD33	3.0	3.3	3.6	V	
Supply voltage 3	VIO	1.62	1.8	1.98	V	
		2.25	2.5	2.75	V	
		3.0	3.3	3.6	V	
Supply voltage 4	VIO_SD	1.62	1.8	1.98	V	
		3.0	3.3	3.6	V	
Supply voltage 5	VIO_RF	3.0	3.3	3.6	V	
Operation temperature range	Taopr	-30	25	85	Degrees C	
Storage temperature range	Tstg	-40	-	85	Degrees C	

Control No. KM-AE-A223020	(1/6)	Control name Electrical characteristics
------------------------------	-------	--

4. Electrical characteristics

4.1. DC Specifications

4.1.1. Power consumption

The Specification applies for Topr.= 25 degrees C, Supply voltage=Typical voltage

No.	Parameter	Condition	Symbol	Min.	Typ.	Max.	Unit	Remark
1	Power consumption1	Tx: 12dBm 11b, 11Mbps	Pc1	-	488	-	mW	Duty=46.8%
2	Power consumption2	Rx 11b, 11Mbps	Pc2	-	201	-	mW	
3	Power consumption3	Tx: 12dBm 11g, 54Mbps	Pc3	-	297	-	mW	Duty=25.4%
4	Power consumption4	Rx 11g, 54Mbps	Pc4	-	211	-	mW	
5	Power consumption5	Tx: 10dBm, 40MHz BW 11n, MCS7, 2.4GHz	Pc5	-	211	-	mW	Duty=2.2%
6	Power consumption6	Rx, 40MHz BW 11n, MCS7, 2.4GHz	Pc6	-	251	-	mW	
7	Power consumption7	Tx: 12dBm 11a, 54Mbps	Pc9	-	363	-	mW	Duty=25.4%
8	Power consumption8	Rx 11a, 54Mbps	Pc10	-	244	-	mW	
9	Power consumption9	Tx: 10dBm , 40MHz BW 11n, MCS7, 5GHz	Pc11	-	244	-	mW	Duty=2.4%
10	Power consumption10	Rx, 40MHz BW 11n, MCS7, 5GHz	Pc12	-	286	-	mW	
11	Power consumption11	Tx: 8dBm, 80MHz BW 11ac, MCS9, 5GHz	Pc13	-	321	-	mW	Duty=1.4%
12	Power consumption12	Rx, 80MHz BW 11ac, MCS9, 5GHz	Pc14	-	358	-	mW	
13	Power consumption13	Power save mode (DTIM=1, Beacon_interval =100ms), BT Sleep mode	Pc15	-	23.5	-	mW	
14	Power consumption14	WLAN=Deep Sleep / BT Sleep	Pc16	-	16.5	-	mW	

*The power consumption might fluctuate with the condition of radio communication, host performance and test circuit.

*The Typ. is a reference value. The value may change depending on the evaluation.

4.1.2. Digital Pad Ratings (SDIO, PCM, GPIO)

(VIO=1.8 / 3.3V)

No.	Parameter	Condition	Symbol	Min.	Typ.	Max.	Unit	Remark
1	Input High Voltage		VIH	0.7xVIO	-	VIO+0.4	V	
2	Input Low Voltage		VIL	-0.4	-	0.3xVIO	V	
3	Output High Voltage		VOH	VIO-0.4	-	-	V	
4	Output Low Voltage		VOL	-	-	0.4	V	

Control No. KM-AE-A223020	(2/6)	Control name Electrical characteristics
------------------------------	-------	--

4.2. AC Specifications

4.2.1. Power-on timing / External sleep clock

[Voltage level for SLP_CLK should be 1.8V]

No.	Parameter	Condition	Symbol	Min.	Typ.	Max.	Unit	Remark
1	Valid Power/ Clock to PDn de-asserted		Tpor	300	-		ms	
2	Input SLP_CLK frequency · ± 250ppm (Initial, aging, temperature)		Tf	-	32.768	-	KHz	
3	Input SLP_CLK high voltage	V=1.8V	V _{IH}	0.7*V	-	V+0.4	V	
4	Input SLP_CLK low voltage		V _{IL}	-0.4	-	0.3*V	V	
5	Input SLP_CLK phase noise requirement		PN	-	-125	-	dBc/Hz	@100kHz
6	Input SLP_CLK slew rate limit (10-90%)		SR	-	-	100	ns	
7	Input SLP_CLK duty cycle tolerance		DC	20	-	80	%	
8	PDN down to Power off		Toff	0	-	-	ms	

<Power-on sequence>

PDn must remain asserted for minimum of Tpor after VBAT/VDD33/VIO/VIO_RF/VIO_SD and SLP_CLK are stable.

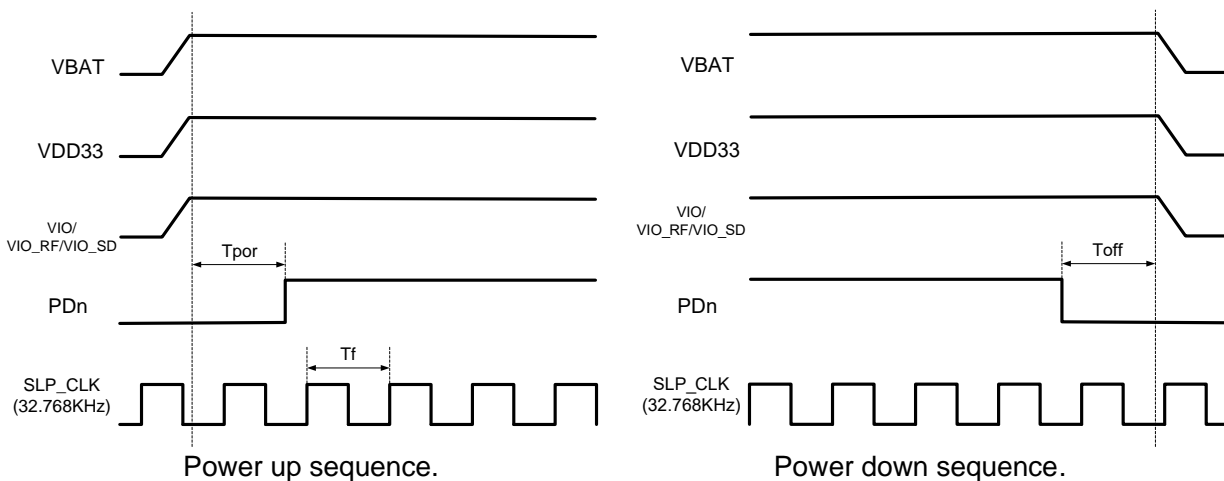

4.2.2. External power down (PDn)

No.	Parameter	Condition	Symbol	Min.	Typ.	Max.	Unit	Remark
1	PDn pulse width		Tppw	300	-	-	ms	

1. PDn should be asserted while VBAT/VDD33/VIO/VIO_RF/VIO_SD are stable.

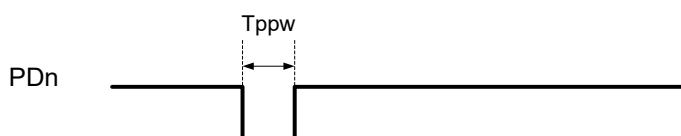

Control No. KM-AE-A223020	(3/6)	Control name Electrical characteristics
------------------------------	-------	--

4.2.3. SDIO Interface Specifications

The Specification applies for Topr.= 25 degrees C , Supply voltage=Typical voltage.

No.	Parameter	Symbol	Condition	Min.	Typ.	Max.	Unit	Remark
1	Input SDIO_CLK Frequency	Tf	Normal	0	-	25	MHz	VIO_SD =3.3V
			High Speed	0	-	50		
2	Input SDIO_CLK High Time	Tch	Normal	10	-	-	ns	
			High Speed	7	-	-		
3	Input SDIO_CLK Low Time	Tcl	Normal	10	-	-	ns	
			High Speed	7	-	-		
4	Input SDIO_CMD, DATA[3:0] Setup time	Tsu	Normal	5	-	-	ns	
			High Speed	6	-	-		
5	Input SDIO_CMD, DATA[3:0] Hold time	TKM	Normal	5	-	-	ns	
			High Speed	2	-	-		
6	Output SDIO_CMD, DATA[3:0] Delay time	Tod	Normal	-	-	14	ns	CL<40pF (1card)
			High-Speed	-	-	14	ns	
7	Output SDIO_CMD, DATA[3:0] Hold time	Toh	High Speed	2.5	-	-	ns	

Normal Mode

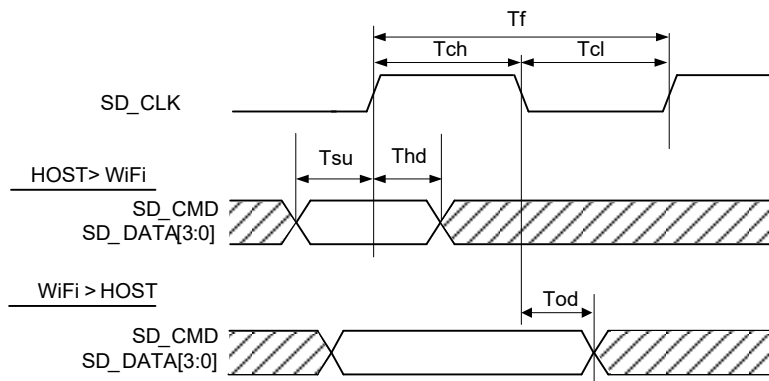

High Speed Mode

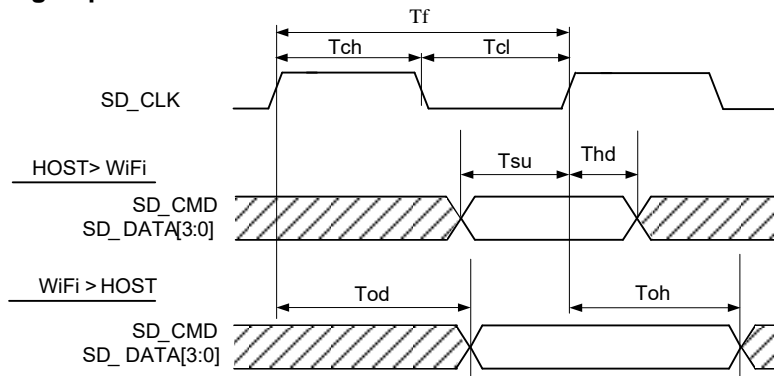

Control No. KM-AE-A223020	(4/6)	Control name Electrical characteristics
------------------------------	-------	--

4.2.4. SDIO Interface Specifications

The Specification applies for Topr.= 25 degrees C , Supply voltage=Typical voltage.

No.	Parameter	Symbol	Condition	Min.	Typ.	Max.	Unit	Remark
1	Clock Frequency	fpp	SDR12/25/50	25	-	100	MHz	VIO_SD =1.8V
			SDR104	0	-	150		
2	Input setup time	Tis	SDR12/25/50	3	-	-	ns	
			SDR104	1.4	-	-		
3	Input hold time	Tih	SDR12/25/50	0.8	-	-	ns	
			SDR104	0.8	-	-		
4	Clock time	Tclk	SDR12/25/50	10	-	40	ns	
			SDR104	4.8	-	-		
5	Rise time,fall time Tcr,Tcfs < 2ns(max)at100MHz Ccard=10pF	Tcr,Tcf	SDR12/25/50	-	-	0.2*Tclk	ns	
			SDR104	-	-	0.2*Tclk		
6	Output delay time CI ≤ 30pF	Todly	SDR12/25/50	-	-	7.5	ns	
7	Output hold time CI=15pF	Toh	SDR12/25/50	1.5	-	-	ns	
8	Card output phase	Top	SDR104	0	-	10	ns	
9	Output timing of variable data window	Todw	SDR104	2.88	-	-	ns	

SDIO Protocol Timing Diagram-SDR12,SDR25,SDR50

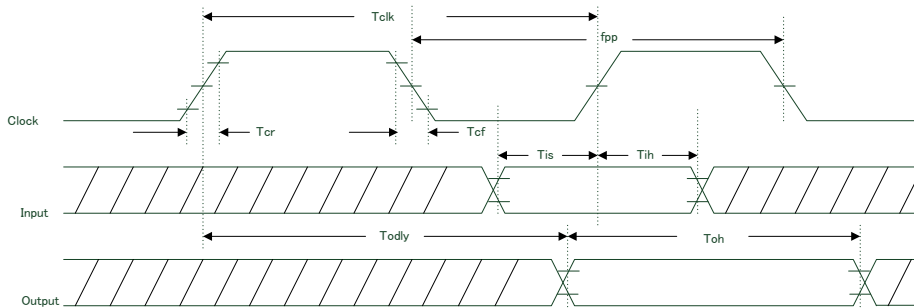

SDIO Protocol Timing Diagram-SDR104

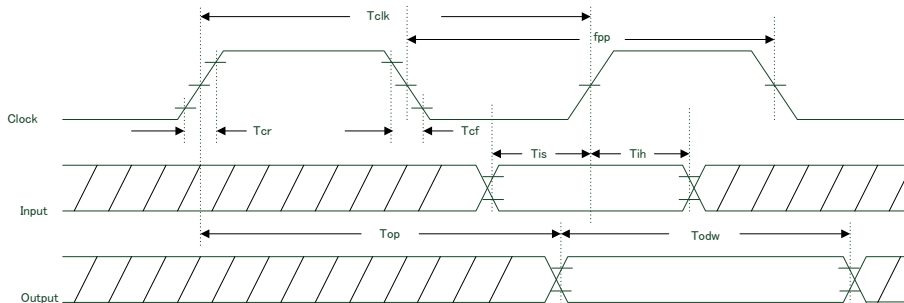

Control No. KM-AE-A223020	(5/6)	Control name Electrical characteristics
------------------------------	-------	--

4.2.5. PCM Interface

The Specification applies for Topr.= 25 degrees C, Supply voltage=Typical voltage.

No.	Parameter	Condition	Symbol	Min.	Typ.	Max.	Unit	Remark
1	PCM_CLK Frequency		Tbclk	-	2 / 2.048	-	MHz	
2	Delay time from PCM_CLK High to valid PCM_OUT		Tdo	-	-	15	ns	
4	Setup time for PCM_IN valid to PCM_CLK Low		Tdisu	20	-	-	ns	
5	Hold time for PCM_CLK Low to PCM_IN valid		Tdiho	15	-	-	ns	
6	Delay time from PCM_CLK High to PCM_SYNC High		Tbf	-	-	15	ns	

Master Mode

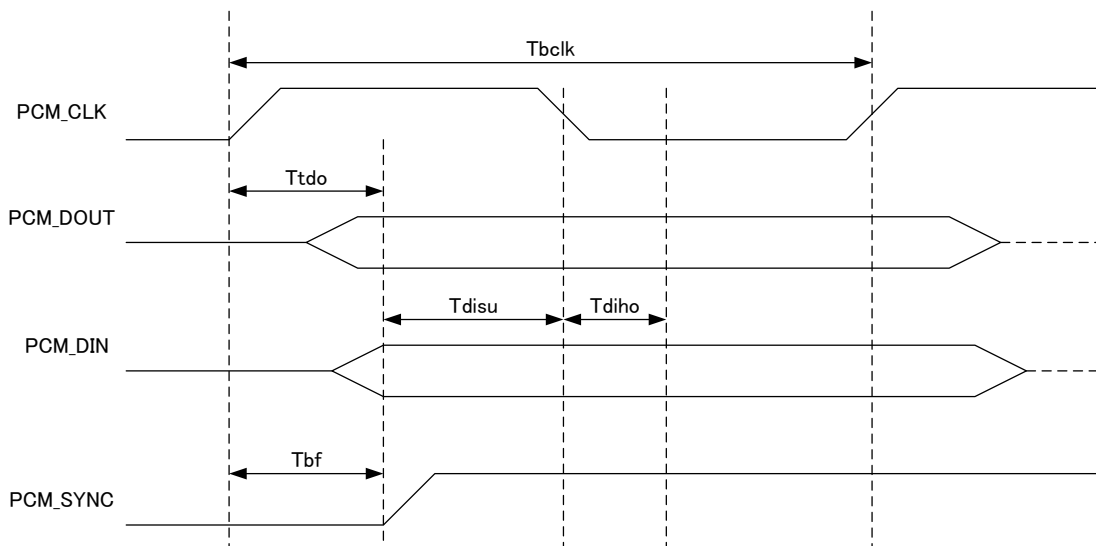

Control No. KM-AE-A223020	(6/6)	Control name Electrical characteristics
------------------------------	-------	--

4.3. RF Specifications

4.3.1. WLAN 2.4GHz Band

The Specification applies for Topr.= 25 degrees C, Supply voltage=Typical voltage

No.	Parameter	Condition	Symbol	Min.	Typ.	Max.	Unit	Remark
1	TX Power	11Mbps, 11b	Po2-1	10	12	14	dBm	
		54Mbps, 11g	Po2-2	10	12	14		
		MCS7, 20MHz BW, 11n	Po2-3	10	12	14		
		MCS7, 40MHz BW, 11n	Po2-4	8	10	12		
2	Rx sensitivity	11Mbps, 11b	SEN2-1	-	-87	-76	dBm	
		54Mbps, 11g	SEN2-2	-	-73	-65		
		MCS7, 20MHz BW, 11n	SEN2-3	-	-69	-64		
		MCS7, 40MHz BW, 11n	SEN2-4	-	-66	-61		

4.3.2. WLAN 5GHz Band

The Specification applies for Topr.= 25 degrees C, Supply voltage=Typical voltage

No.	Parameter	Condition	Symbol	Min.	Typ.	Max.	Unit	Remark
1	TX Power	54Mbps, 11a	Po5-1	10	12	14	dBm	
		MCS7, 20MHz BW, 11n	Po5-2	10	12	14		
		MCS7, 40MHz BW, 11n	Po5-3	8	10	12		
		MCS9, 80MHz BW, 11ac	Po5-4	6	8	10		
2	Rx sensitivity	54Mbps, OFDM	SEN5-1	-	-71	-65	dBm	
		MCS7, 20MHz BW, OFDM	SEN5-2	-	-68	-64		
		MCS7, 40MHz BW, OFDM	SEN5-3	-	-65	-61		
		MCS9, 80MHz BW, OFDM	SEN5-4	-	-57	-51		

4.3.3. Bluetooth®

The Specification applies for Topr.= 25 degrees C, Supply voltage =Typical voltage.

No.	Parameter	Condition	Symbol	Min.	Typ.	Max.	Unit	Remark
1	Tx Power	Basic	Pob-2	-6	0	2	dBm	Class2
2	Sensitivity	Basic	SENB	-	-86	-70	dBm	

Control No. KM-MC-A223020	(1/2)	Control name Circuit Schematic
------------------------------	-------	-----------------------------------

5. Circuit Schematic

5.1. Block Diagram

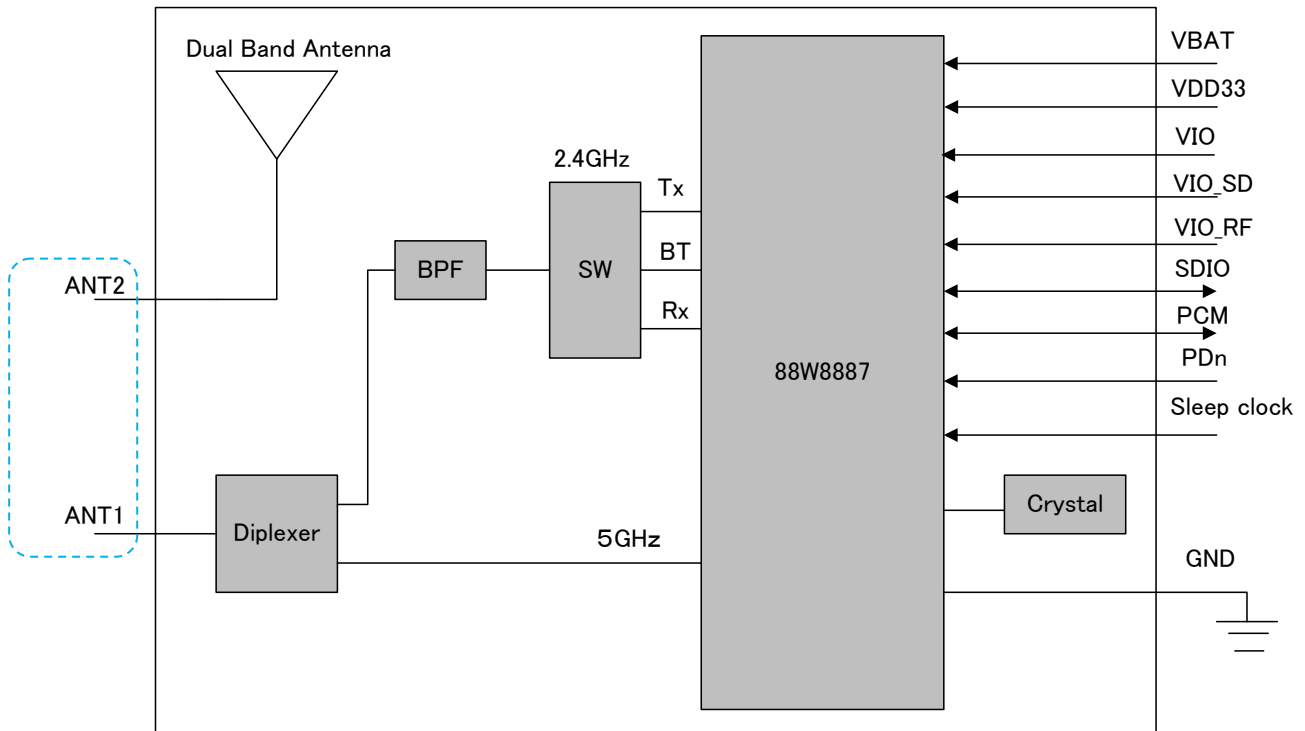

In order to use the module mounted antenna, ANT1 and ANT2 need to be connected. When designing PCB board for the end product, please connect Pad42-Pad43 at the shortest length.

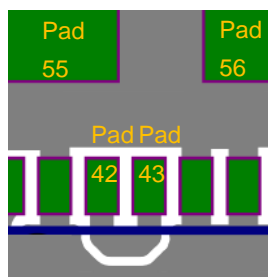

Control No. KM-MC-A223020	Control name (2/2) Circuit Schematic
------------------------------	---

5.2. Example of peripheral circuit schematics

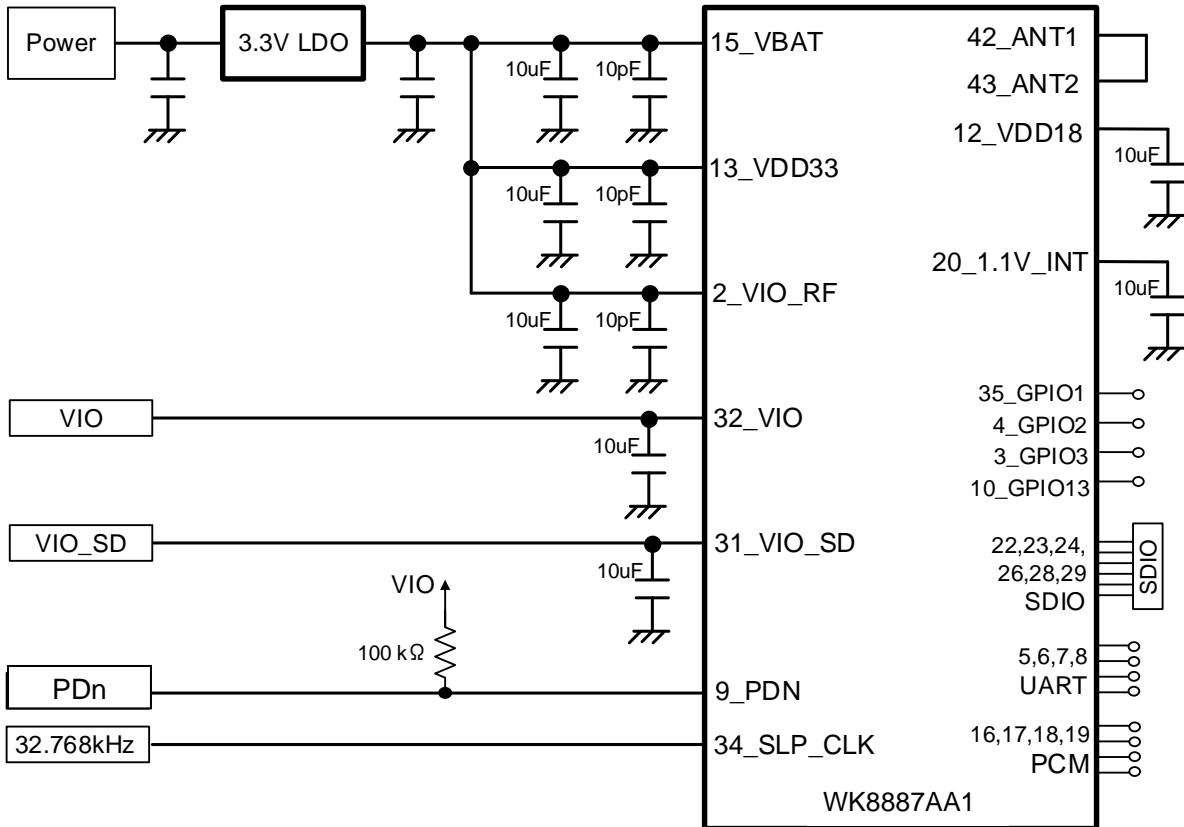

Control No. KM-AD-A223020	(1/4)	Control name Outline/Appearance
------------------------------	-------	------------------------------------

6. Outline/Appearance

6.1. OUTLINE

Unit: mm, Tolerances unless otherwise specified: $\pm 0.2\text{mm}$

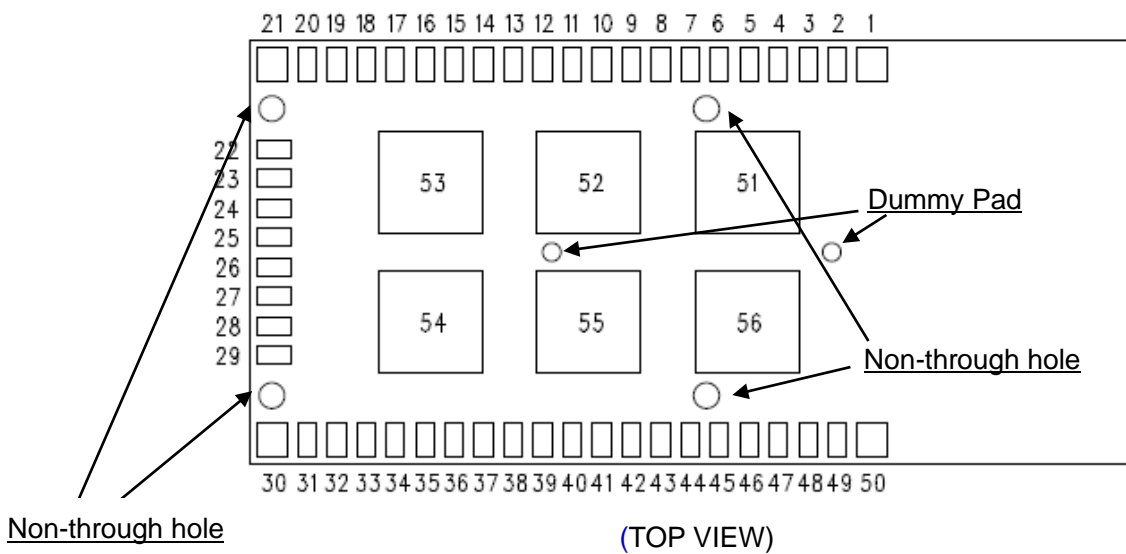
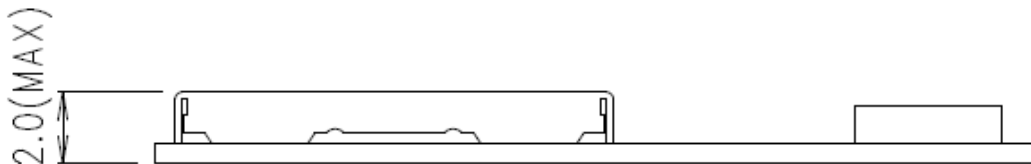
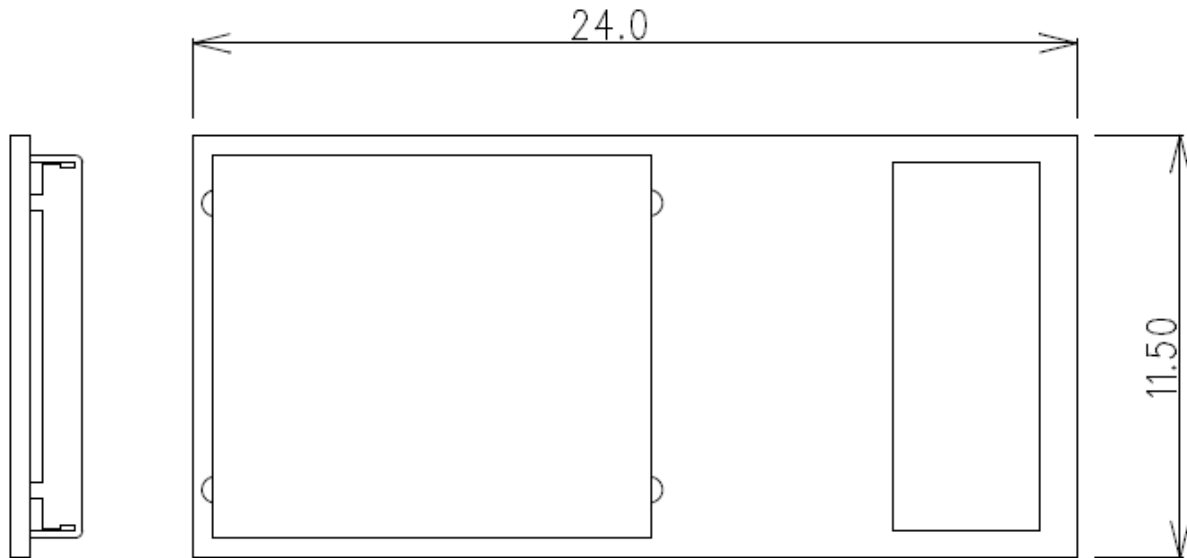

Control No. KM-AD-A223020	Control name Outline/Appearance
------------------------------	------------------------------------

6.2. Module Pad Dimension

Unit: mm, Tolerances unless otherwise specified: $\pm 0.2\text{mm}$

(TOP VIEW)

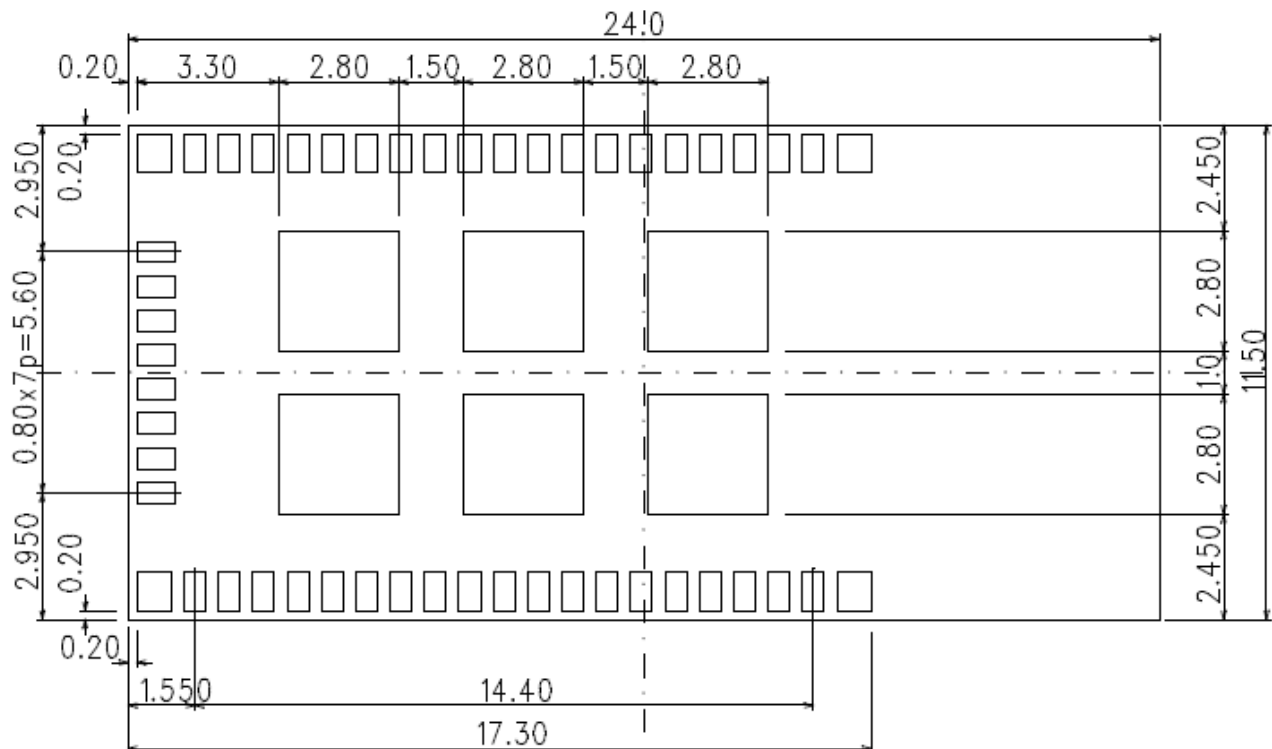

46_Signal Pad : 0.50 x 0.90

4_Corner Pad : 0.80 x 0.90

6_Center Pad : 2.80 x 2.80

Control No. KM-AD-A223020	Control name Outline/Appearance
------------------------------	------------------------------------

6.3. Recommended Land Pattern Dimension

Pad sizes on the motherboard should be the same size as the module pad sizes.

6.4. Recommended Metal Mask (Solder Mask) Conditions

Mask size see below. Thickness of the Metal Mask should be in the range of 0.1 mm

Unit: mm

(TOP VIEW)

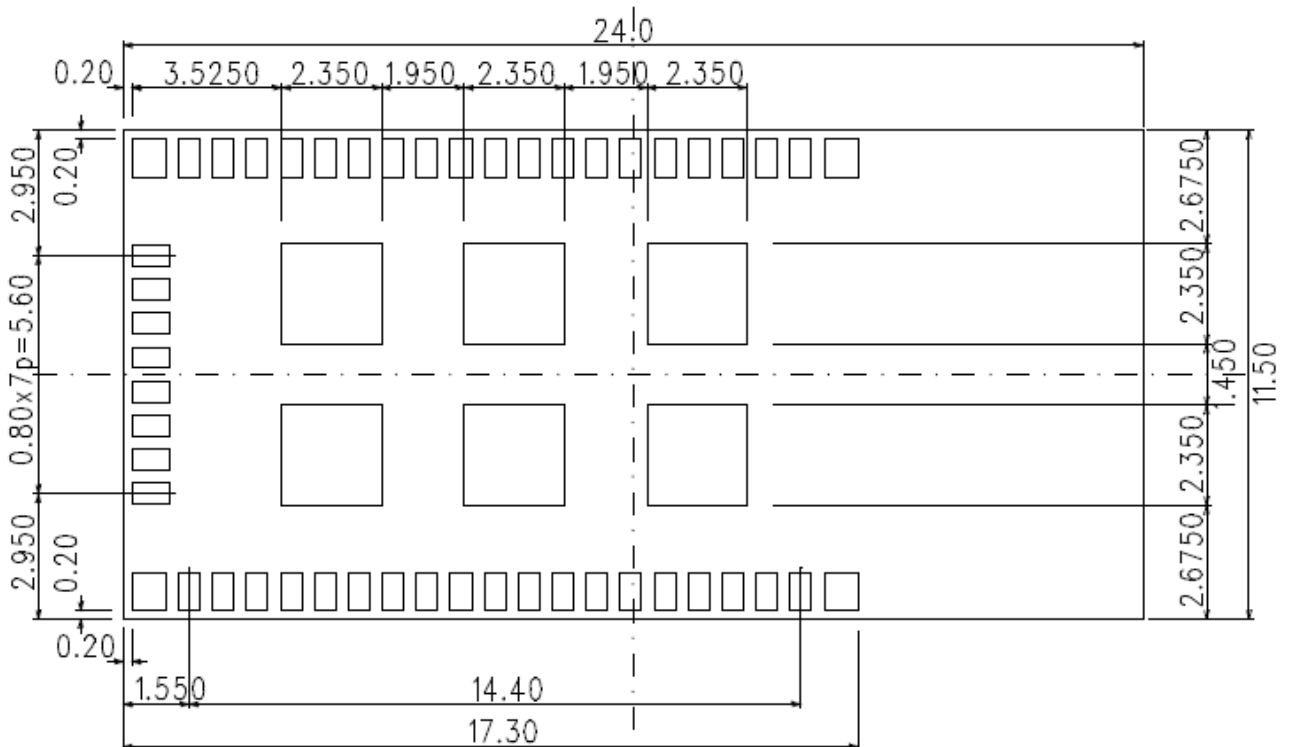

46_Signal Pad Metal Mask Opening : 0.50 x 0.90

4_Corner Pad Metal Mask Opening : 0.80 x 0.90

6_Center Pad Metal Mask Opening : 2.35 x 2.35

Control No. KM-AD-A223020	(4/4)	Control name Outline/Appearance
------------------------------	-------	------------------------------------

6.5. Marking Information

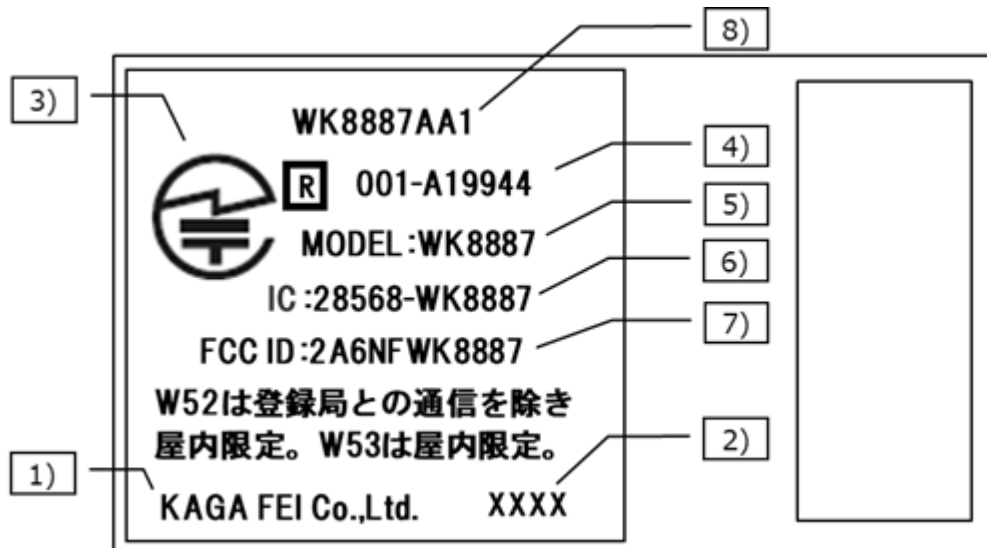

- 1) Manufacturer : KAGA FEI Co.,Ltd.
- 2) Lot number : Four digits
- 3) Japan technical conformity mark
- 4) Japan ID : 001-A19944
- 5) Model : WK8887
- 6) ISED ID : 28568-WK8887
- 7) FCC ID : 2A6NFWK8887
- 8) Part number : WK8887AA1

Control No. KM-BA-A223020	(1/3)	Control name Pin Layout
------------------------------	-------	----------------------------

7.Pin Layout

Pin No.	Module pin Name	I/O	Power Domain	Description	Function	Internal PU
1	GND	-	GND	Ground	PWR	-
2	VIO_RF	I	VIO_RF	3.3V Analog I/O RF Power Supply	PWR	-
3	GPIO3, CON[1]	I	VIO_RF	Configuration Mode: CON[1], See Table-1	CTRL	Enable
4	GPIO2, CON[0]	I	VIO_RF	Configuration Mode: CON[0], See Table-1	CTRL	Enable
5	UART_RTS	O	VIO	UART_RTSn Please put out the test terminal.	UART	Enable
6	UART_CTS	I	VIO	UART_CTSn Please put out the test terminal.	UART	Enable
7	UART_SIN	I	VIO	UART_SIN Please put out the test terminal.	UART	Enable
8	UART_SOUT	O	VIO	UART_SOUT Please put out the test terminal.	UART	Enable
9	PDn	I	VIO	Power Down (no internal pull-up on this pin) (0: Full Power Down, 1: Normal Operation)	CTRL	None
10	GPIO13/BT_WAKEUP_ BT_HOST	O	VIO	Bluetooth wakeup host (Output).	CTRL	-
11	GND	-	GND	Ground	PWR	-
12	VDD18	O	VDD18	1.8V buck voltage output	PWR	-
13	VDD33	I	VDD33	3.3V Analog Power Supply	PWR	-
14	GND	-	GND	Ground	PWR	-
15	VBAT	I	VBAT	1.1v buck/1.8v buck/3.3v LDO VBAT input	PWR	-
16	PCM_DIN/PCM_A	I	VIO	PCM Data Input Signal	PCM	Enable
17	PCM_CLK	I/O	VIO	PCM Clock Signal. (Output if PCM master. Input if PCM slave.)	PCM	Enable
18	PCM_SYNC	I/O	VIO	PCM Sync Pulse Signal. (Output if PCM master. Input if PCM slave.)	SDIO	Enable
19	PCM_DOUT/PCM_B	O	VIO	PCM Data Output Signal	PCM	Enable
20	1.1V_INT	O	VDD11	1.1V buck voltage output	PWR	-
21	GND	-	GND	Ground	PWR	-
22	SD_D2	I/O	VIO_SD	SDIO Data line Bit[2]	SDIO	Enable
23	SD_D3	I/O	VIO_SD	SDIO Data line Bit[3]	SDIO	Enable
24	SD_CMD	I/O	VIO_SD	SDIO Command/Response	SDIO	Enable
25	GND	-	GND	Ground	PWR	-
26	SD_CLK	I	VIO_SD	SDIO Clock Input	SDIO	Enable
27	GND	-	GND	Ground	PWR	-
28	SD_D0	I/O	VIO_SD	SDIO Data line Bit[0]	SDIO	Enable
29	SD_D1	I/O	VIO_SD	SDIO Data line Bit[1]	SDIO	Enable
30	GND	-	GND	Ground	PWR	-
31	VIO_SD	I	VIO_SD	1.8/3.3V Digital SDIO Power Supply.	PWR	-
32	VIO	I	VIO	1.8/2.5/3.3V Digital Power Supply	PWR	-

Control No. KM-BA-A223020	(2/3)	Control name Pin Layout
------------------------------	-------	----------------------------

Pin No.	Module pin Name	I/O	Power Domain	Description	Function	Internal PU
33	GND	-	GND	Ground	PWR	-
34	SLP_CLK	I	VDD18	Sleep Clock Input SLP_CLK is used for reference clock detection and sleep mode. Please input SLP_CLK even when sleep mode is not used.	CLOCK	-
35	GPIO1/WL_HOST_WAKE	O	VIO	WLAN wakeup HOST (Output)	CTRL	
36	RES	-	-	Reserved. Do not connect this pin. Leave this pin floating.	-	
37	TMS	I	VIO	JTAG Controller Select	JTAG	Enable
38	TDI	I	VIO	JTAG Test Data Input	JTAG	Enable
39	TDO	O	VIO	JTAG Test Data Output	JTAG	Enable
40	TCK	I	VIO	JTAG Test Clock Input	JTAG	Enable
41	GND	-	GND	Ground	PWR	-
42	ANT1	I/O	-	RF I/O, should be connected to Pin 43	RF I/O	-
43	ANT2	I/O	-	Internal antenna, should be connected to Pin 42	Antenna	-
44	GND	-	GND	Ground	PWR	-
45	GND	-	GND	Ground	PWR	-
46	RES	-	-	Reserved. Do not connect this pin. Leave this pin floating.	-	-
47	RES	-	-	Reserved. Do not connect this pin. Leave this pin floating.	-	-
48	RES	-	-	Reserved. Do not connect this pin. Leave this pin floating.	-	-
49	RES	-	-	Reserved. Do not connect this pin. Leave this pin floating.	-	-
50	GND	-	GND	Ground	PWR	-
51	GND	-	GND	Ground	PWR	-
52	GND	-	GND	Ground	PWR	-
53	GND	-	GND	Ground	PWR	-
54	GND	-	GND	Ground	PWR	-
55	GND	-	GND	Ground	PWR	-
56	GND	-	GND	Ground	PWR	-

Control No. KM-BA-A223020 (3/3)	Control name Pin Layout
------------------------------------	----------------------------

Table-1 HOST Interface / FW down load select

CON[1]	CON[0]	WLAN	BT/BLE
0	0	00,01	
0	1	reserved	
1	0	SDIO	UART
1	1	SDIO	SDIO

Note) The 88W8887 firmware and driver does not support UART as a Bluetooth host interface. However, please add UART test points to your design because the UART terminal may be needed during Bluetooth qualification testing.

Control No. MQ-H-001	(1/2)	Control name Handling Precaution
-------------------------	-------	-------------------------------------

8. Handling Precaution

This specification describes desire and conditions especially for mounting.

8.1.Desire/Conditions

(1) Environment conditions for use and storage

1. Store the components in an environment of < **40deg-C/90%RH** if they are in a moisture barrier bag packed by KAGA FEI .
2. Keep the factory ambient conditions at < **30deg-C/60%RH** .
3. Store the components in an environment of < **25±5deg-C/10%RH** after the bag is opened.
(The condition is also applied to a stay in the manufacture process).

(2) Conditions for handling of products

Make sure all of the moisture barrier bags have no holes, cracks or damages at receiving. If an abnormality is found on the bag, its moisture level must be checked in accordance with 2 in (2).

Refer to the label on the bag.

1. All of the surface mounting process (reflow process) must be completed **in 12 months** from the bag sea date.
2. Make sure humidity in the bag is less than **10%RH** immediately after open, using a humidity indicator card sealed with the components.
3. **All** of the surface mounting process (reflow process including rework process) must be completed in **168 hours** after the bag is opened (inclusive of any other processes).
4. If any conditions in (1) or condition 2 and 3 in (2) are not met, bake the components in accordance with the conditions at **125deg-C 24hours**
5. As a rule, baking the components in accordance with conditions 4 in (2) shall be once.
6. Since semi-conductors are inside of the components, they must be free from static electricity while handled.(<100V) Use ESD protective floor mats, wrist straps, ESD protective footwear, air ionizers etc. , if necessary.
7. Please make sure that there are lessen mechanical vibration and shock for this module, and do not drop it.
8. Please recognize pads of back side at surface mount.
9. Washing the module is not recommended. If washing cannot be avoided, please test module functionality and performance after thoroughly drying the module.
We cannot be held responsible for any failure due washing the module.
10. Please perform temperature conditions of module at reflow within the limits of the following.

Please give the number of times of reflow as a maximum of 2 times.

Control No. MQ-H-001	(2/2)	Control name Handling Precaution
-------------------------	-------	-------------------------------------

Recommended Reflow Profile

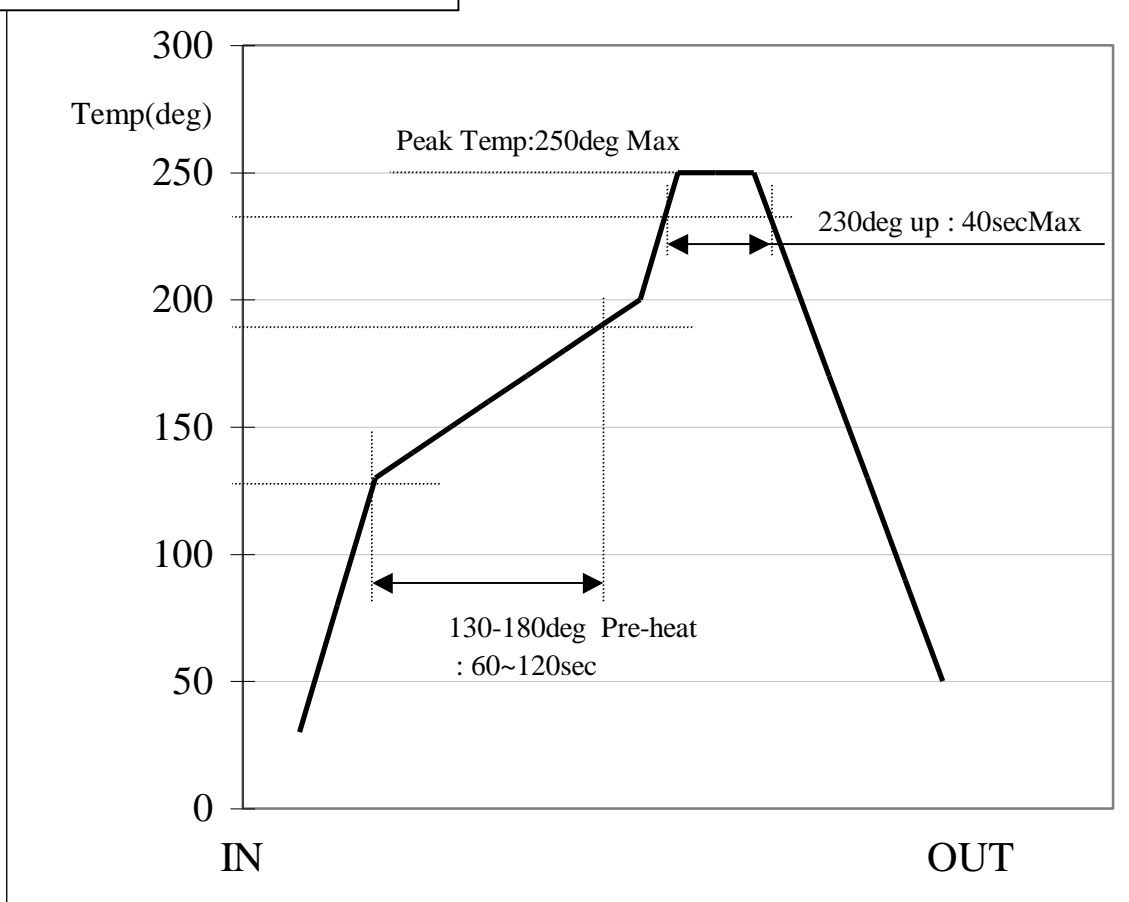

Control No. KM-BB-A223020	(2/3)	Control name Packaging Specification
------------------------------	-------	---

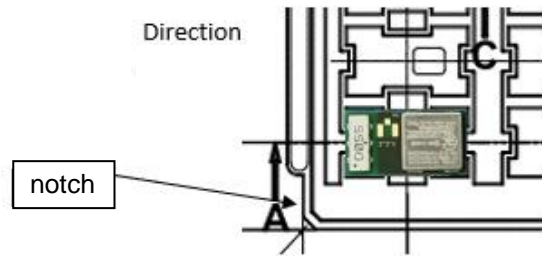

Inner Box

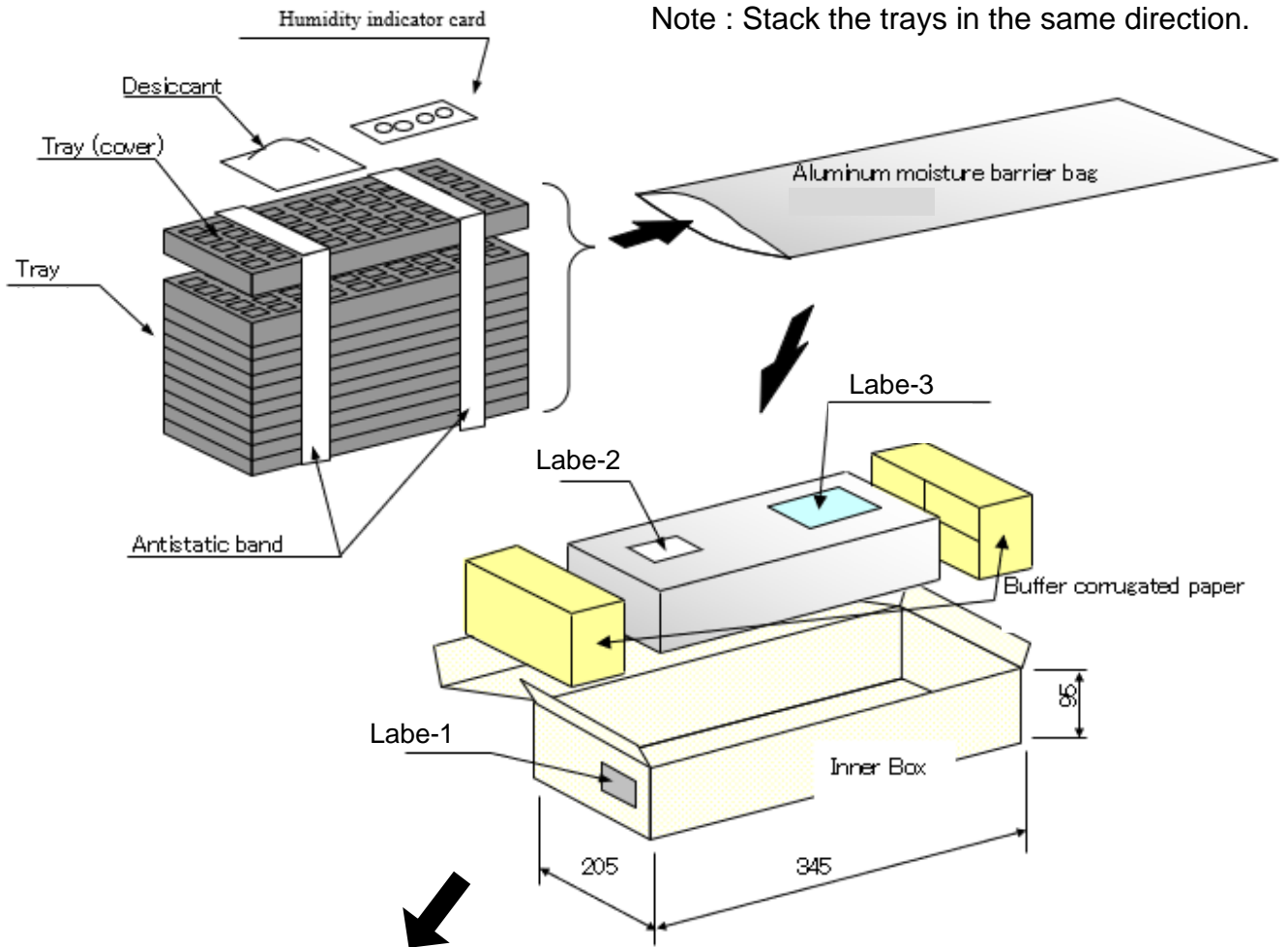

Outer Box

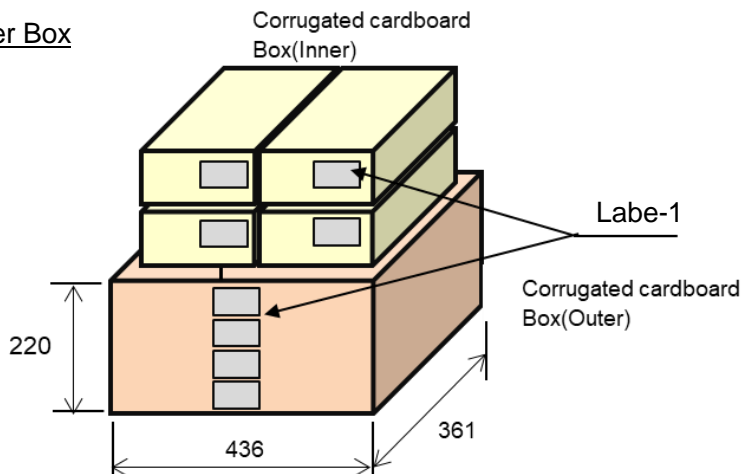

Control No. KM-BB-A223020	(3/3)	Control name Packaging Specification
------------------------------	-------	---

(4) Label

Label-1

- Purchase order
- Part No.
- Quantity
- Lot No.
- Country of origin

Label-2

- Serial No.
- Part No.
- Quantity
- Country of origin

Label-3

- Caution label
- MSL Level 3

Control No. (1/4)	Control name Antenna Application Note
----------------------	--

10. Antenna Application Note

1. Recommended module mounting example

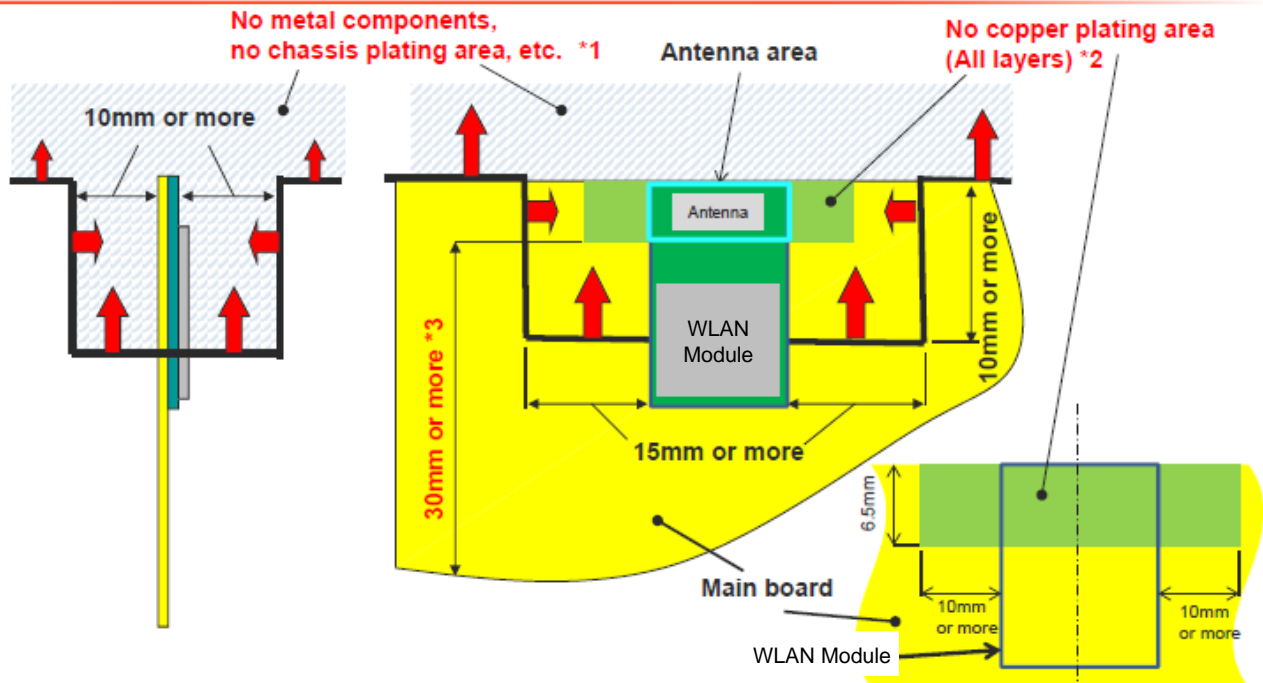

- *1 Please do not place any metal components in **blue shaded space.*1)** We do not recommend to place any metal objects upper space of the module in the above figure. If it needs to place metal objects, please consider to keep the metal off from the antenna as far as you can. Such as signal line and metal chassis as possible except for main board while mounting the components in *1 space on the main board is allowed except for no copper plating area. (*2).
- *2 This area is routing prohibited area on the main board. Please do not place copper on any layer. Please remain use of FR-4 dielectric material. The antenna is tuned with the FR-4.
- *3 Characteristics may deteriorate when **GND pattern** length is less than 30mm. It should be 30 mm or more as possible.

Even when above mentioned condition is satisfied, communication performance may be significantly deteriorated

Control No. (2/4)	Control name Antenna Application Note
----------------------	--

2. Other module mounting examples

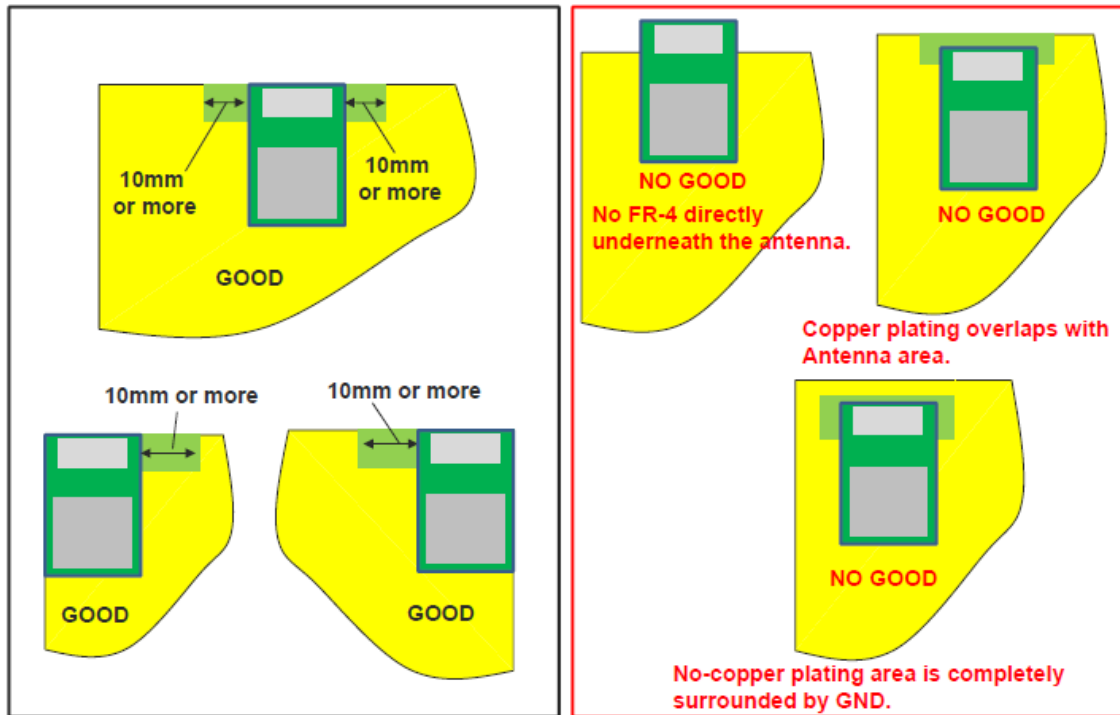

3. Placement of resin or plastic parts

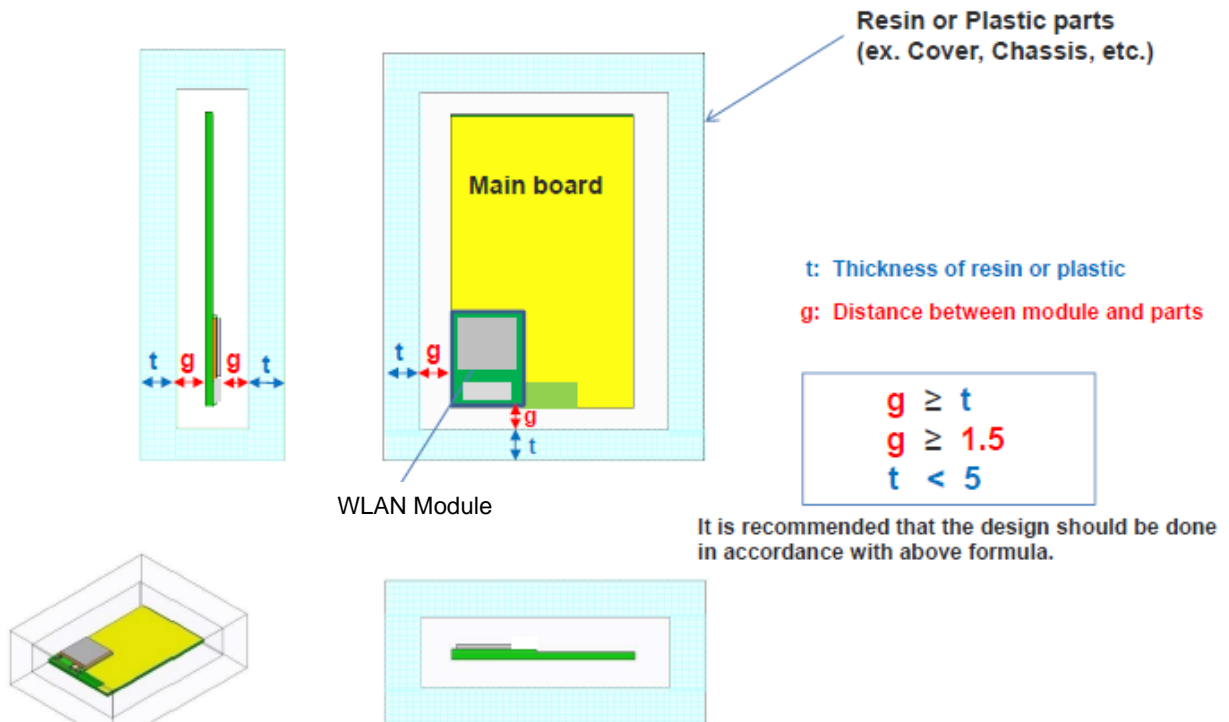

Please do not apply molding over the antenna area of WLAN module.

Control No.	Control name
(3/4)	Antenna Application Note

4. Directional characteristics example (when mounted on evaluation board) 2.4GHz Band

Measurement data of antenna

Appearance and coordinates definition

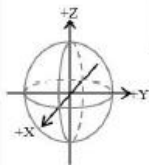

Frequency [MHz]	@2400	@2450	@2500	
Peak gain [dBi]				
3-plane	TX-H	-2.6	-0.7	-0.1
	TX-V	-6.6	-4.4	-3.3
		-2.6	-0.7	-0.1
Average gain [dBi]				
XY-plane	TX-H	-6.6	-4.1	-3.4
	TX-V	-24.4	-22.4	-22.2
	Plus(H,V)	-6.6	-4.0	-3.4
YZ-plane	TX-H	-15.1	-12.6	-12.1
	TX-V	-9.3	-7.2	-5.9
	Plus(H,V)	-8.3	-6.1	-5.0
ZX-plane	TX-H	-7.8	-5.7	-4.7
	TX-V	-18.6	-16.0	-15.9
	Plus(H,V)	-7.5	-5.3	-4.4
3-plane	TX-H	-8.6	-6.2	-5.5
	TX-V	-13.5	-11.3	-10.2
		-7.4	-5.0	-4.2
Efficiency [dB]	-6.2	-3.8	-3.0	
VSWR [1]	4.3	2.0	1.6	

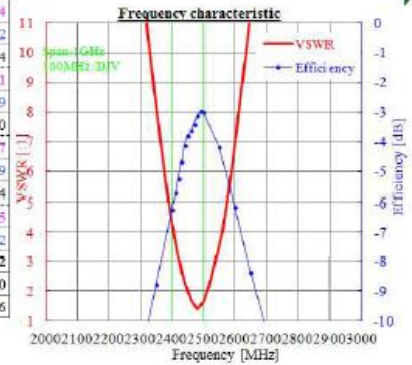

*Note: Peak gain(3-plane)=Peak(XY[H][XY[V]],YZ[H][YZ[V]],ZX[H][ZX[V]])

*Note: The value is average value in 1 round of each inclination direction angle.

*Note: Average gain(3-plane)=Average(XY[Plus(H,V)],YZ[Plus(H,V)],ZX[Plus(H,V)])

Radiation pattern

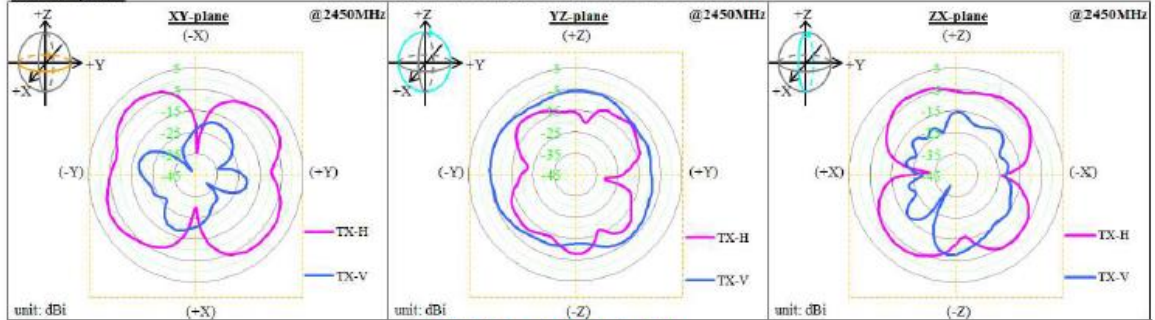

Control No. (4/4)	Control name Antenna Application Note
----------------------	--

5GHz Band

Measurement data of antenna

Appearance and coordinates definition

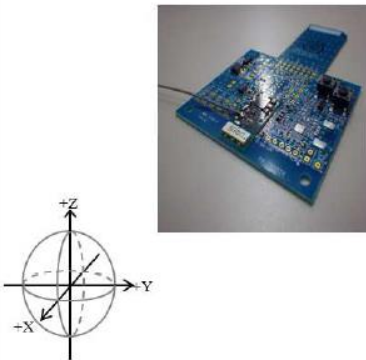

Frequency [MHz]		@5100	@5400	@5800
Peak gain [dBi]				
3-plane	TX-H	1.9	1.3	1.4
	TX-V	2.0	2.0	2.2
Average gain [dBi]				
XY-plane	TX-H	-2.8	-3.3	-4.3
	TX-V	-14.1	-14.1	-12.3
	Plus(H,V)	-2.5	-2.9	-3.6
YZ-plane	TX-H	-5.5	-5.3	-5.8
	TX-V	-2.6	-2.7	-2.5
	Plus(H,V)	-0.8	-0.8	-0.8
ZX-plane	TX-H	-6.7	-6.4	-5.8
	TX-V	-13.3	-13.8	-11.6
	Plus(H,V)	-5.8	-5.7	-4.8
3-plane	TX-H	-4.7	-4.8	-5.2
	TX-V	-6.7	-6.9	-6.4
Efficiency [dB]		-2.1	-2.0	-2.0
VSWR [-]		1.9	1.7	1.3

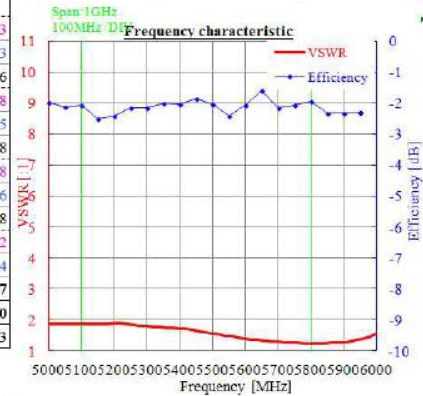

*Note: Peak gain(3-plane)=Peak(XY[H],XY[V],YZ[H],YZ[V],ZX[H],ZX[V])

*Note:The value is average value in 1 round of each inclination direction angle.

*Note: Average gain(3-plane)=Average(XY[Plus(H,V)],YZ[Plus(H,V)],ZX[Plus(H,V)])

Radiation pattern

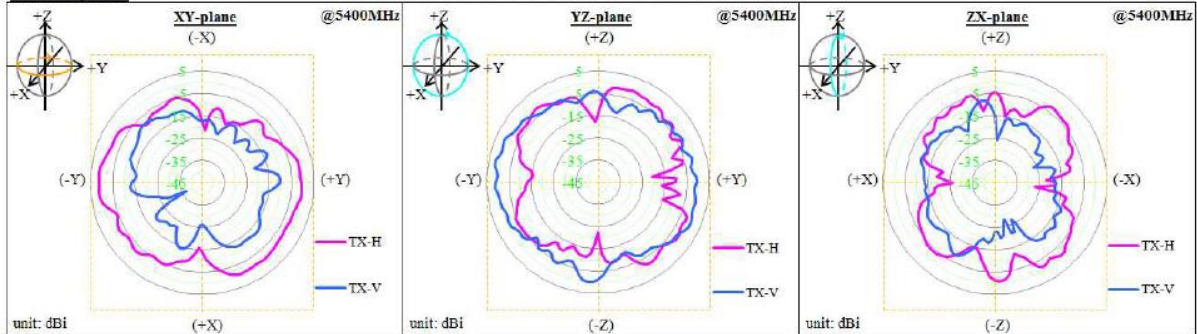

5. About this Application Note

- This Application Note has been prepared as a reference material to help obtaining the antenna performance mounted on **WK8887AA1** module better while it is not guaranteed or assured to obtain better communication performance and distance.
- This product “**WK8887AA1** module” has been certified and matching circuit constant for antenna within module cannot be changed when ambient environment condition changes. The product must be re-certified when matching circuit constant is changed.

Precautions

- Please conduct validation and verification of our products in actual condition of mounting and operating environment before using our products.
- The products listed in this Specification are intended for use in general electronic equipment (e.g., AV equipment, OA equipment, home electric appliances, office equipment, information and communication equipment including, without limitation, mobile phone, and PC). Please be sure to contact KAGA FEI for further information before using the products for any equipment which may directly cause loss of human life or bodily injury (e.g., transportation equipment including, without limitation, automotive powertrain control system, train control system, and ship control system, traffic signal equipment, disaster prevention equipment, medical equipment classified as Class I, II or III by IMDRF, highly public information network equipment including, without limitation, telephone exchange, and base station).
Please do not incorporate our products into any equipment requiring high levels of safety and/or reliability (e.g., aerospace equipment, aviation equipment, medical equipment classified as Class IV by IMDRF, nuclear control equipment, undersea equipment, military equipment).
When our products are used even for high safety and/or reliability-required devices or circuits of general electronic equipment, it is strongly recommended to perform a thorough safety evaluation prior to use of our products and to install a protection circuit as necessary.
Please note that unless you obtain prior written consent of KAGA FEI, KAGA FEI shall not be in any way responsible for any damages incurred by you or third parties arising from use of the products listed in this Specification for any equipment requiring inquiry to KAGA FEI or prohibited for use by KAGA FEI as described above.
- Information contained in this Specification is intended to convey examples of typical performances and/or applications of our products and is not intended to make any warranty with respect to the intellectual property rights or any other related rights of KAGA FEI or any third parties nor grant any license under such rights.
- Please note that the scope of warranty for our products is limited to the delivered our products themselves and KAGA FEI shall not be in any way responsible for any damages resulting from a fault or defect in our products.
- The contents of this Specification are applicable to our products which are purchased from our sales offices or authorized distributors (hereinafter “KAGA FEI’s official sales channel”). Please note that the contents of this specification are not applicable to our products purchased from any seller other than KAGA FEI’s official sales channel.
- The contents of this Specification are applied in preference to any agreement between you and KAGA FEI or KAGA FEI's official sales channel (e.g., supply and purchase agreement, quality assurance agreement).
- You will have deemed accepted the contents of this Specification upon usage of our products.
- Caution for Export
Some of our products listed in this specification may require specific procedures for export according to "U.S. Export Administration Regulations" and other applicable regulations.

Mouser Electronics

Authorized Distributor

Click to View Pricing, Inventory, Delivery & Lifecycle Information:

[EverPro:](#)

[WK8887AA1-EVB](#) [WK8887AA1-EVK](#)

[Kaga FEI:](#)

[WK8887AA1](#)