

XStream-PKG-E™ Ethernet RF Modem

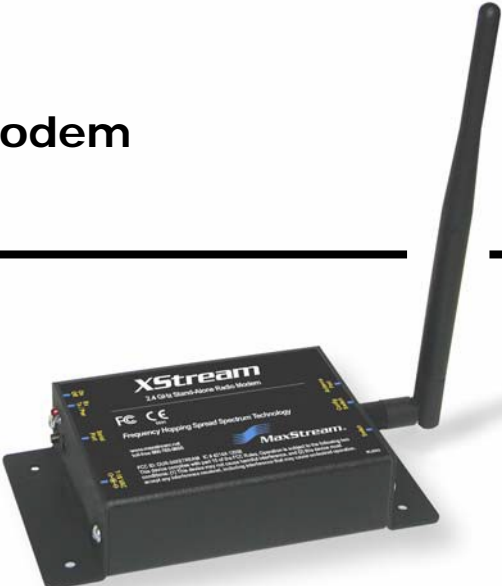

Product Manual [v4.2B5](#)

For XStream RF Modem Part Numbers

X09-001PK...-E...
X09-009PK...-E...
X09-019PK...-E...

X24-009PK...-E...
X24-019PK...-E...

XH9-001PK...-E...
XH9-009PK...-E...
XH9-019PK...-E...

Reliable 900 MHz and 2.4 GHz Stand-alone RF Modems by Digi International Inc.

XStream-PKG-E Ethernet RF Modem – Product Manual v4.2B5

(Part number 90002208 B)

Revision	Date	Description
B	10/15/14	Minor changes and new part number

© 2014 Digi International Inc. All rights reserved.

Digi, Digi International Inc., the Digi logo, and XStream® are trademarks or registered trademarks in the United States and other countries worldwide. All other trademarks mentioned in this document are the property of their respective owners.

Information in this document is subject to change without notice and does not represent a commitment on the part of Digi International. Digi provides this document “as is,” without warranty of any kind, expressed or implied, including, but not limited to, the implied warranties of fitness or merchantability for a particular purpose. Digi may make improvements and/or changes in this manual or in the product(s) and/or the program(s) described in this manual at any time.

Contents

1. XStream Ethernet RF Modem	4	Appendix A: Agency Certifications	30
1.1. Features Overview	4	FCC Certification	30
1.1.1. Worldwide Acceptance	4	FCC Notices	30
1.2. Product Overview	5	OEM Labeling Requirements	31
1.2.1. Specifications	5	Antenna Usage	31
1.3. External Interface	6	FCC Approved Antennas	32
1.3.1. Front and Back Views	6	IC (Industry Canada) Certification	33
2. System Setup	7	<u>Appendix B: Additional Information</u>	<u>34</u>
2.1. Data Radio System Components	7	Contact Digi	35
2.1.1. System Description	7		
2.2. Com Port Communications	8		
2.2.1. Install Software	8		
2.2.2. Range Test (XCTU)	8		
3. RF Modem Operation	9		
3.1. Idle Mode	9		
3.2. Transmit Mode	10		
3.2.1. RF Packet	10		
3.3. Receive Mode	11		
3.4. Sleep Mode	12		
3.5. Command Mode	14		
3.5.1. AT Command Mode	14		
3.5.2. Binary Command Mode	15		
4. RF Modem Configuration	16		
4.1. Hands-On Programming Examples	16		
4.1.1. Configuration Setup Options	16		
4.1.2. AT Command Mode	17		
4.1.3. Binary Command Mode	17		
4.2. Command Reference Table	18		
4.3. Command Descriptions	19		

1. XStream Ethernet RF Modem

XStream-PKG-E Ethernet RF Modems extend system performance and flexibility by adding serial connectivity to Ethernet networks.

Digi RF Modems handle the complexities inherent to RF communications (modulation, demodulation, frequency synthesizers, amplifiers, filters, FCC approvals, etc.), so OEMs and integrators can focus resources beyond the wireless portion of the data system.



1.1. Features Overview

Long Range at a Low Cost

- 9XStream-PKG-E (900 MHz) Range:
- Indoor/Urban: **up to 1500'** (450 m)
 - Outdoor line-of-sight: **up to 7 miles** (11 km) w/2.1 dBm dipole antenna
 - Outdoor line-of-sight: **up to 20 miles** (32 km) w/high gain antenna

- 24XStream-PKG-E (2.4 GHz) Range:
- Indoor/Urban: **up to 600'** (180 m)
 - Outdoor line-of-sight: **up to 3 miles** (5 km) w/2.1 dBm dipole antenna
 - Outdoor line-of-sight: **up to 10 miles** (16 km) w/high gain antenna

Receiver sensitivity: **-110 dBm** (@ 900 MHz), **-105 dBm** (@ 2.4 GHz)

Advanced Networking and Security

True Peer-to-Peer (no "master" required), Point-to-Point, Point-to-Multipoint and Multidrop

Retries and Acknowledgements

FHSS (Frequency Hopping Spread Spectrum)

7 hopping channels, each with over 65,000 unique network addresses available

Easy-to-Use

Out-of-Box RF Experience - no configuration required

No Master/Slave setup dependencies

Advanced configurations using Windows software and AT Commands

7-28 VDC power supply

Transparent Operation

Support for multiple data formats (parity and data bits)

Portable (small form factor and low power)

Software-selectable interfacing rates

Support for multiple data formats

XII™ Interference Immunity

Power-saving Sleep Modes (as low as 230 mA)

1.1.1. Worldwide Acceptance

FCC Certified (USA) Refer to Appendix A for FCC Requirements.

Devices that contain XStream RF Modems inherit Digi's FCC Certification.

ISM (Industrial, Scientific and Medical) frequency band

Manufactured under **ISO 9001:2000 registered standards**

9XStream-PKG-E (900 MHz) RF Modems approved for use in **US, Canada, Australia, Israel** (and more).



1.2. Product Overview

The XStream-PKG-E RF Modem comes configured to provide immediate wireless links between devices; however, the RF modem can be configured for additional functionality through the use of a simple AT command interface (Refer to the Command Mode (p18) and RF Modem Configuration (p20) sections for programming options).

1.2.1. Specifications

Table 1-01. XStream-PKG-E Ethernet RF Modem Specifications

Specification	9XStream-PKG-E (900 MHz)		24XStream-PKG-E (2.4 GHz)	
Performance				
Indoor/Urban Range	Up to 1500' (450 m)		Up to 600' (180 m)	
Outdoor LOS Range	Up to 7 miles (11 km) w/ 2.1 dBm dipole antenna Up to 20 miles (32 km) w/ high-gain antenna		Up to 3 miles (5 km) w/ 2.1 dBm dipole antenna Up to 10 miles (16 km) w/ high-gain antenna	
Transmit Power Output	100 mW (20 dBm)		50 mW (17 dBm)	
Interface Data Rate	Software selectable 125 – 65,000 bps (Including non-standard baud rates)		Software selectable 125 – 65,000 bps (Including non-standard baud rates)	
Throughput Data Rate	9,600 bps	19,200 bps	9,600 bps	19,200 bps
RF Data Rate	10,000 bps	20,000 bps	10,000 bps	20,000 bps
Receiver Sensitivity	-110 dBm	-107 dBm	-105 dBm	-102 dBm
Power Requirements				
Supply Voltage	7-28 VDC		7-28 VDC	
Receive (RX) Current*	240 mA (@ 9V)		260 mA (@ 9V)	
Transmit (TX) Current*	320 mA (@ 9V)		340 mA (@ 9V)	
Power Down Current*	230 mA (@ 9V)		230 mA (@ 9V)	
General				
Frequency	902-928 MHz		2.4000-2.4835 GHz	
Spread Spectrum	Frequency Hopping, Wide band FM modulator			
Network Topology	Peer-to-Peer, Point-to-Point, Point-to-Multipoint, Multidrop			
Supported Network Protocols	ARP, UDP, TCP, ICMP, Telnet, TFTP, AutoIP, DHCP, HTTP and SNMP (read-only)			
Channel Capacity	7 hop sequences share 25 frequencies			
Data Connection	RJ-45 Female Ethernet Connection			
Physical Properties				
Enclosure	Extruded aluminum, black, anodized			
Enclosure Size	2.750" x 5.500" x 1.125" (6.99cm x 13.97cm x 2.86cm)			
Weight	7.1 oz. (200g)			
Operating Temperature	0 to 70° C (commercial), -40 to 85° C (industrial)			
Antenna				
Type	½ wave dipole whip, 6.75" (17.1 cm), 2.1 dBi Gain			
Connector	Reverse-polarity SMA (RPSMA)			
Impedance	50 ohms unbalanced			
Certifications				
FCC Part 15.247	OUR9XSTREAM		OUR-24XSTREAM	
Industry Canada (IC)	4214A-9XSTREAM		4214A 12008	

* Divide by 2 for 18V supply (constant wattage from 7 to 28V)

1.3. External Interface

1.3.1. Front and Back Views

Figure 1-01. Front View

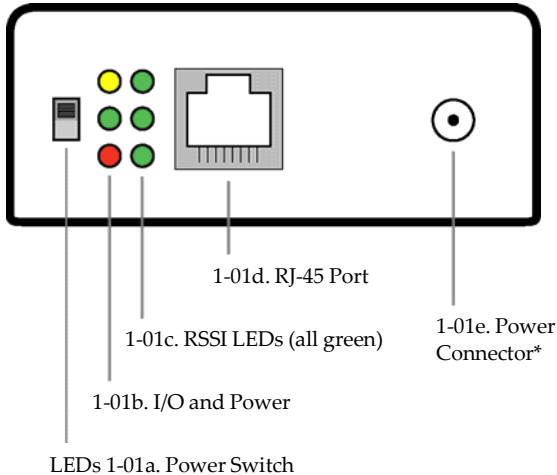

LEDs 1-01a. Power Switch

* The Ethernet RF Modem does not support Power-over-Ethernet (PoE). The device cannot be powered directly from a PoE port on a compatible hub.

However, it may be useful to send power on the unused wires of the CAT-5 cable in situation where the radio will be mounted in a location that optimizes radio coverage but may not have a power outlet nearby. There are several third part devices available that can inject the power onto the cable and then remove it at the remote side.

1-01a. Power Switch

Move Power Switch to the ON (up) position to power the XStream PKG-E Ethernet RF Modem.

1-01b. I/O and Power LEDs

LEDs indicate modem activity as follows:

- Yellow (top LED) = Serial Data Out (to host)
- Green (middle) = Serial Data In (from host)
- Red (bottom) = Power/TX Indicator (Red light is on when powered and pulses off briefly during RF transmission)



1-01c. RSSI LEDs

RSSI LEDs indicate the amount of fade margin present in an active wireless link. Fade margin is the difference between the incoming signal strength and the modem's receiver sensitivity.

- 3 LEDs ON = Very Strong Signal (> 30 dB fade margin)
- 2 LEDs ON = Strong Signal (> 20 dB fade margin)
- 1 LED ON = Moderate Signal (> 10 dB fade margin)
- 0 LED ON = Weak Signal (< 10 dB fade margin)

1-01d. RJ-45 Ethernet Port

Standard Female RJ-45 connector is used to connect unshielded twisted-pair CAT5 cabling.

1-1 e. Power Connector *

7-28 VDC Power Connector.

Figure 1-02. Back View

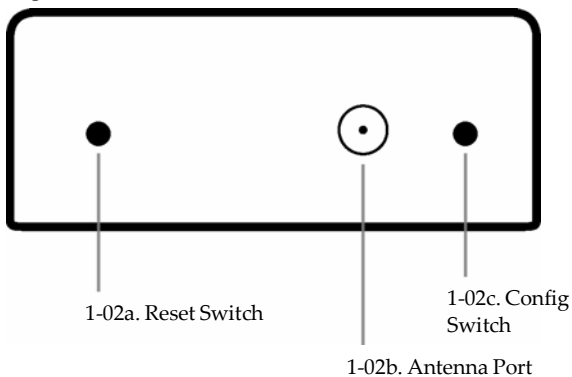

1-02a. Reset Switch

1-02b. Antenna Port

1-02c. Config Switch

1-2 a. Reset Switch

Reset Switch forces the RF Modem to reset (or re-boot).

1-02b. Antenna Port

Antenna Port is a 50 Ω RF signal connector for connecting to an external antenna. Connector type is Reverse Polarity (RPSMA) female. The RPSMA has threads on the outside of a barrel and a male center conductor.

1-02c. Config (Configuration) Switch

The Config Switch provides an alternate way to enter AT Command Mode.

To enter Command Mode at the Modem's default baud rate: Simultaneously press the Reset (1-02a) and Config switches; release the Reset Switch; then after 1 sec., release the Config Switch. The RF Modem then enters AT Command Mode at the modem's default baud rate.

2. System Setup

2.1. Data Radio System Components

XStream Radio Modems are designed to provide long range wireless links between devices of a data system. The PKG-E Ethernet RF Modem connects serial modems to Ethernet networks.

The following devices will be used to describe a data system that includes the XStream-PKG-E Ethernet RF Modem:



XStream-PKG-E Ethernet RF Modem (“PKG-E”): The Ethernet RF Modem is an Ethernet-connected serial modem used for communication with other Digi serial modems. The Ethernet RF Modem is not a wireless Ethernet Bridge intended for Ethernet connectivity on both the remote and base sides of a wireless link.



XStream-PKG-R RS-232/485 RF Modem (“PKG-R”): The RS-232/485 RF Modem is a serial modem that can be identified by its DB-9 serial port and 6-switch DIP Switch.

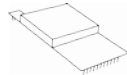

XStream OEM RF Module (“OEM RF Module”): The OEM RF Module is mounted inside all XStream-PKG RF Modems and may be integrated into OEM-designed products to transmit and receive data over-the-air.

2.1.1. System Description

The PKG-E Ethernet RF Modem can be used as an access point in a network of Digi RS- 232/RS-485 RF Modems (or other OEM RF Module Embedded Devices). XStream RF Modems support point-to-point, peer-to-peer, point-to-multipoint and multidrop network topologies. Below is an example of a typical point-to-multipoint application:

Figure 2-01. XStream-PKG-E Ethernet RF Modem in a Point-to-Multipoint Data Radio System

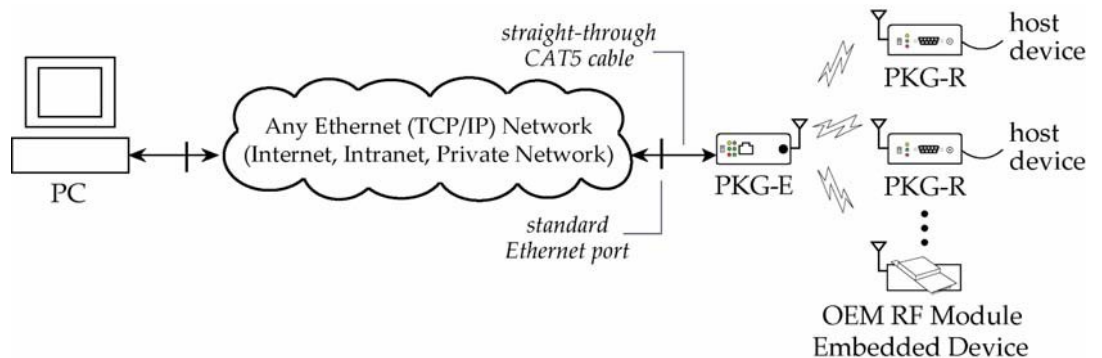

2.2. Com Port Communications

2.2.1. Install Software

The XCTU and Com Port Redirector software facilitate communications through a PC's com port. Follow the instructions below to setup a com port for configuring and testing RF modems.

Installation #1: XCTU Software

Go to the XCTU Software page at www.digi.com/xctu and click "Download". Launch the appropriate XCTU installer and follow the prompts on the installation screens.

Installation #2: Ethernet Com Port Redirector

Go to the Knowledge Base page at www.digi.com/support/kbase. In the "Keyword" box, type "2033" and press "Search". Click the link to the Knowledge Base article for detailed instructions on how to install the Device Installer and Com Port Redirector.

2.2.2. Range Test (XCTU)

When testing a wireless link, Digi suggests creating the link using the following components:

- XStream-PKG-E Ethernet RF Modem (connected to a local network)
- XStream-PKG-R RS-232/485 RF Modem (w/ loopback adapter)
- PC (connected to a local network)
- Accessories (Loopback adapter, CAT5 UTP cable, power supplies and RPSMA antennas)

Hardware Setup:

1. Connect the XStream-PKG-E (Ethernet) RF Modem and a PC to active Ethernet ports of the same local network using CAT5 cables (included w/ PKG-EA accessories package).
2. Attach the serial loopback adapter to the DB-9 serial connector of the XStream-PKG-R (RS-232) RF Modem. The serial loopback adapter configures the PKG-R RF Modem to function as a repeater by looping serial data back into the modem for retransmission.
3. Configure the PKG-R (RS-232) RF Modem for RS-232 operation using the built-in DIP Switch. Dip Switch 1 should be ON (up) and the remaining switches should be OFF (down).
4. Attach RPSMA antennas to both RF Modems.
5. Power both RF Modems with power supplies (included w/ accessories package).



Figure 2-06. Hardware Setup for Range Test

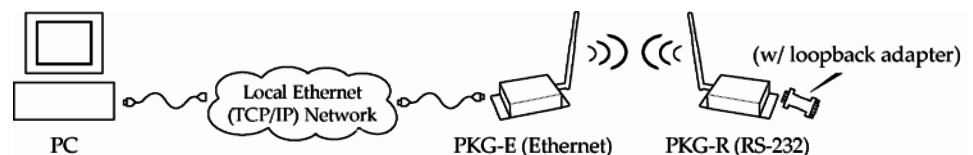

Run Range Test:

Launch XCTU and click on "Help Contents" located under the question mark button. Refer to Section 5.5 – Range Test Tool of the XCTU User's Guide for detailed instructions on how to conduct a range test using XCTU.

3. RF Modem Operation

An on-board RF module enables the XStream-PKG-E RF Modem to send and receive data over-the-air. The RF module operates in five modes.

Figure 3-01. RF Modem Modes of Operation

The modem can only be in one mode at a time.

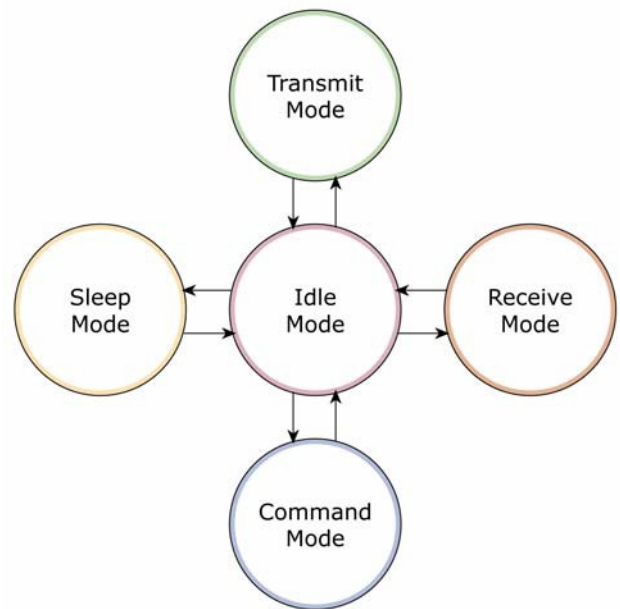

3.1. Idle Mode

When not receiving or transmitting data, the module is in Idle Mode. The module uses the same amount of power in Idle Mode as it does in Receive Mode.

The modem shifts into the other modes of operation under the following conditions:

- Serial data is received in the DI Buffer (Transmit Mode)
- Valid RF data is received through the antenna (Receive Mode)
- Command Mode Sequence is issued (Command Mode)
- Sleep Mode condition is met (Sleep Mode)

After responding to any of the preceding conditions, the modem automatically transitions back into Idle Mode.

3.2. Transmit Mode

When the first byte of serial data is received from the UART in the DI buffer, the modem attempts to shift to Transmit Mode and initiate an RF connection with other modems.

Figure 3-02. Transmission of Data

Once in Transmit Mode, the modem initializes a communications channel. Channel initialization is the process of sending an RF initializer that synchronizes receiving modems with the transmitting modem. When streaming multiple RF packets, the RF Initializer is only sent in front of the first packet. During channel initialization, incoming serial data accumulates in the DI buffer.

After the channel is initialized, data in the DI buffer is grouped into packets (up to 64 bytes in each packet) and is transmitted. The modem continues to transmit data packets until the DI buffer is empty. Once transmission is finished, the modem returns to Idle Mode. This progression is shown above.

As the transmitting modem nears the end of the transmission, it inspects the DI buffer to see if more data exists to be transmitted. This could be the case if more bytes arrived from the host after the transmission began. If more data is pending, the transmitting modem assembles a subsequent packet for transmission.

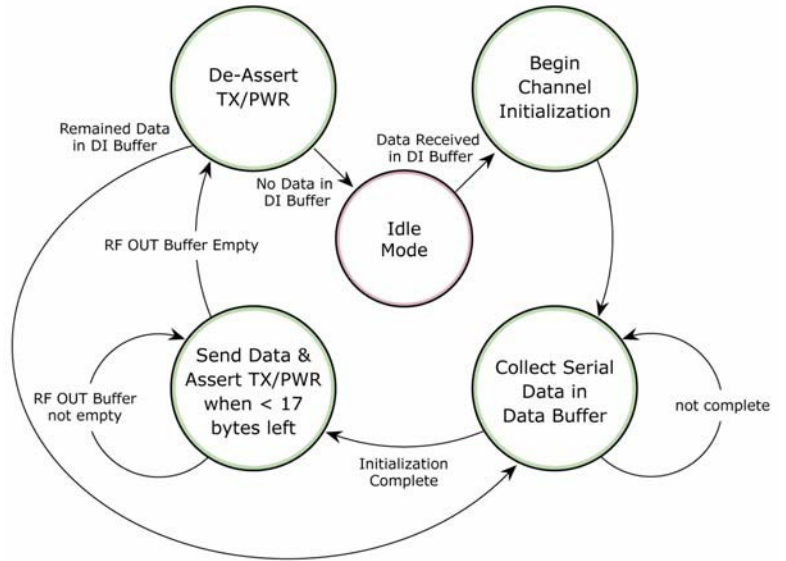

3.2.1. RF Packet

The RF packet is the sequence of data used for communicating information between Digi Modems. An RF Packet consists of an RF Initializer and RF Data.

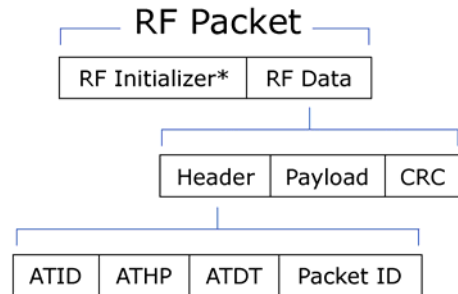

Figure 3-03. RF Packet Components

* When streaming multiple RF packets, the RF Initializer is only sent in front of the first packet.

RF Initializer

An RF initializer is sent each time a new connection sequence begins. The RF initializer contains channel information that notifies receiving modems of information such as the hopping pattern used by the transmitting modem. The first transmission always sends an RF initializer.

An RF initializer can be of various lengths depending on the amount of time determined to be required to prepare a receiving modem. For example, a wake-up initializer is a type of RF initializer used to wake remote modems from Sleep Mode (Refer to the FH, LH, HT and SM Commands for more information). The length of the wake-up initializer should be longer than the length of time remote modems are in cyclic sleep.

Header

The header contains network addressing information that is used to filter incoming RF data. The receiving modem checks for matching a VID, Hopping Channel and Destination Address. Data that does not pass through all three network filter layers is discarded.

Figure 3-04. Filtration layers contained in the header

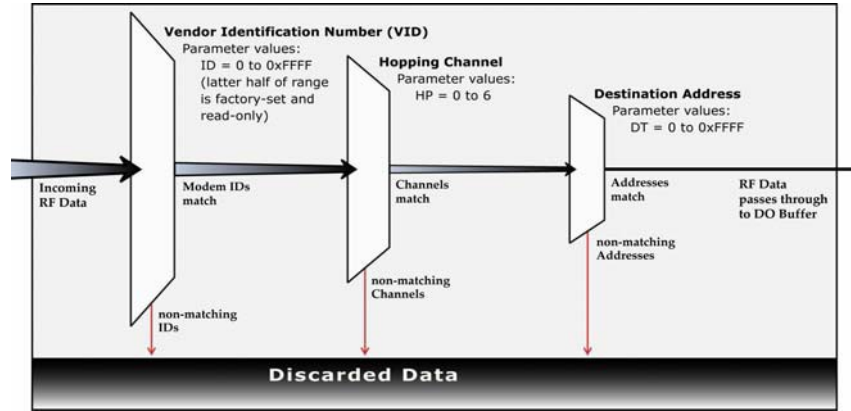

CRC (Cyclic Redundancy Check)

To verify data integrity and provide built-in error checking, a 16-bit CRC (Cyclic Redundancy Check) is computed for the transmitted data and attached to the end of each RF packet. On the receiving end, the receiving modem computes the CRC on all incoming RF data. Received data that has an invalid CRC is discarded (Refer to Receive Mode section).

3.3. Receive Mode

If a modem detects RF data while operating in Idle Mode, the modem transitions into Receive Mode to start receiving RF packets.

Figure 3-05. Reception of RF Data →

After a packet is received, the modem checks the CRC (cyclic redundancy check) to ensure that the data was transmitted without error. If the CRC data bits on the incoming packet are invalid, the packet is discarded. If the CRC is valid, the packet proceeds to the DO Buffer.

The modem returns to Idle Mode after valid RF data is no longer detected or after an error is detected in the received RF data. If serial data is stored in the DI buffer while the modem is in Receive Mode, the serial data will be transmitted after the modem is finished receiving data and returns to Idle Mode.

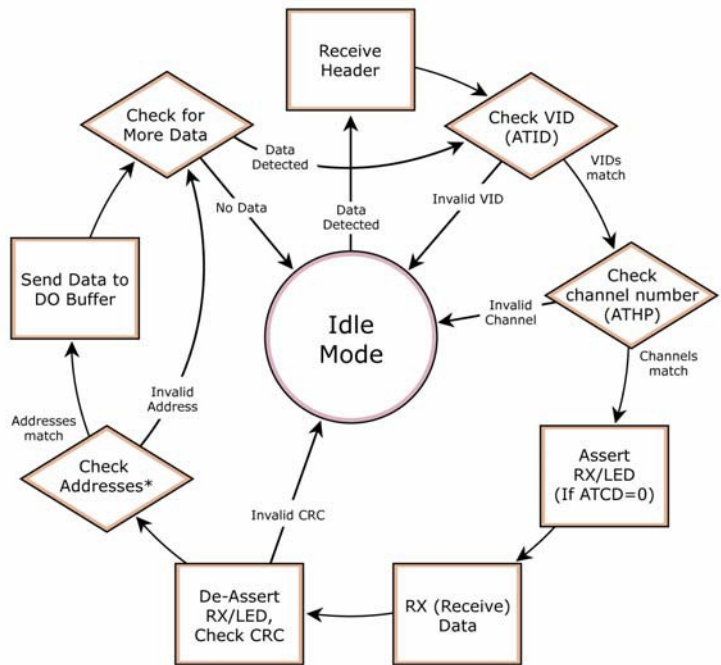

3.4. Sleep Mode

Sleep Modes enable the XStream Modem to operate at minimal power consumption when not in use. Three Sleep Mode options are available:

- Pin Sleep (Host Controlled)
- Serial Port Sleep (Wake on Serial Port activity)
- Cyclic Sleep (Wake on RF activity)

For the modem to transition into Sleep Mode, the modem must have a non-zero SM (Sleep Mode) Parameter and one of the following must occur:

1. The modem is idle (no data transmission or reception) for a user-defined period of time (Refer to ST (Time before Sleep) Command).
2. SLEEP pin is asserted (only for Pin Sleep option).

In Sleep Mode, the modem will not transmit or receive data until the modem first transitions to Idle Mode. All Sleep Modes are enabled and disabled using SM Command. Transitions into and out of Sleep Modes are triggered by various mechanisms as shown in the table below.

Table 3-01. Summary of Sleep Mode Configurations

Sleep Mode Setting	Transition into Sleep Mode	Transition out of Sleep Mode	Related Commands
Pin Sleep (SM = 1)	A microcontroller can shut down and wake modems by asserting (high) SLEEP pin. Note: The module will complete a transmission or reception before activating Pin Sleep.	De-assert SLEEP pin.	SM
Serial Port Sleep (SM = 2)	Automatic transition to Sleep Mode occurs after a user-defined period of inactivity (no transmitting or receiving of data). The period of activity is defined using the ST (Time before Sleep) Command.	When serial byte is received on the DI pin.	SM, ST
Cyclic Sleep (SM = 3-8)	Automatic transition to Sleep Mode occurs in cycles as defined by the SM (Sleep Mode) Command. Note: The cyclic sleep time interval must be shorter than the "Wake-up Initializer Timer" (set by LH Command).	After the cyclic sleep time interval elapses. Note: Modem can be forced into Idle Mode if PW (Pin Wake-up) Command is issued.	SM, ST, HT, LH, PW

For more information about Sleep Modes, refer to the individual commands listed in "Related Commands" column of the table.

Pin Sleep (SM = 1)

Pin Sleep requires the least amount of power. In order to achieve this state, DI3 (SLEEP) pin must be asserted (high). The modem remains in Pin Sleep until the DI3 pin is de-asserted.

After enabling Pin Sleep, the SLEEP pin controls whether the XStream Modem is active or in Sleep Mode. When DI3 is de-asserted (low), the modem is fully operational. When DI3 is asserted (high), the modem transitions to Sleep Mode and remains in its lowest power-consuming state until the DI3 (SLEEP) pin is de-asserted. DI3 is only active if the modem is setup to operate in this mode; otherwise the pin is ignored.

Once in Pin Sleep Mode, DO2 (\overline{CTS}) is de-asserted (high), indicating that data should not be sent to the modem. The PWR pin is also de-asserted (low) when the modem is in Pin Sleep Mode.

Note: The module will complete a transmission or reception before activating Pin Sleep.

Serial Port Sleep (SM = 2)

Serial Port Sleep is a Sleep Mode in which the XStream Modem runs in a low power state until serial data is detected on the DI pin.

When Serial Port Sleep is enabled, the modem goes into Sleep Mode after a user-defined period of inactivity (no transmitting or receiving of data). This period of time is determined by ST (Time before Sleep) Command. Once a character is received through the DI pin, the modem returns to Idle Mode and is fully operational.

Cyclic Sleep (SM = 3 - 8)

Cyclic Sleep is the Sleep Mode in which the XStream Modem enters into a low-power state and awakens periodically to determine if any transmissions are being sent.

When Cyclic Sleep settings are enabled, the XStream Modem goes into Sleep Mode after a user-defined period of inactivity (no transmission or reception on the RF channel). The user-defined period is determined by ST (Time before Sleep) Command.

While the modem is in Cyclic Sleep Mode, DO2 (\overline{CTS}) is de-asserted (high) to indicate that data should not be sent to the modem during this time. When the modem awakens to listen for data, DO2 is asserted and any data received on the DI Pin is transmitted. The PWR pin is also de-asserted (low) when the modem is in Cyclic Sleep Mode.

The modem remains in Sleep Mode for a user-defined period of time ranging from 0.5 seconds to 16 seconds (SM Parameters 3 through 8). After this interval of time, the modem returns to Idle Mode and listens for a valid data packet for 100 ms. If the modem does not detect valid data (on any frequency), the modem returns to Sleep Mode. If valid data is detected, the modem transitions into Receive Mode and receives incoming RF packets. The modem then returns to Sleep Mode after a Period of inactivity that is determined by ST "Time before Sleep" Command.

The modem can also be configured to wake from cyclic sleep when SLEEP/DI3 is de-asserted (low). To configure a modem to operate in this manner, PW (Pin Wake-up) Command must be issued. Once DI3 is de-asserted, the modem is forced into Idle Mode and can begin transmitting or receiving data. It remains active until no data is detected for the period of time specified by the ST Command, at which point it resumes its low-power cyclic state.

Note: The cyclic interval time defined by SM (Sleep Mode) Command must be shorter than the interval time defined by LH (Wake-up Initializer Timer). (Refer to figures below.)

Cyclic Scanning. Each RF transmission consists of an RF Initializer and payload. The wake-up initializer contains initialization information and all receiving modems must wake during the wake-up initializer portion of data transmission in order to be synchronized with the transmitting modem and receive the data.

Figure 3-06. Correct Configuration (LH > SM)

Length of the wake-up initializer exceeds the time interval of Cyclic Sleep. The receiver is guaranteed to detect the wake-up initializer and receive the accompanying payload data.

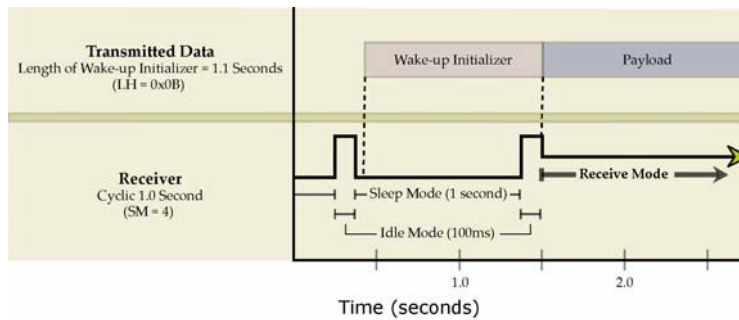
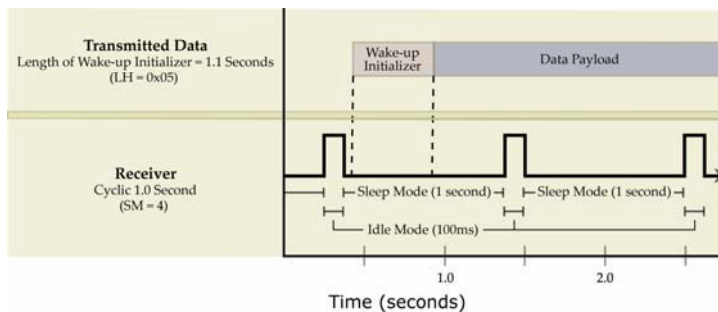

Figure 3-07. Incorrect Configuration (LH < SM)

Length of wake-up initializer is shorter than the time interval of Cyclic Sleep. This configuration is vulnerable to the receiver waking and missing the wake-up initializer (and therefore also the accompanying payload data).



3.5. Command Mode

To modify or read RF module parameters, the module must first enter into Command Mode - a state in which incoming characters are interpreted as commands and parameters. Two command types are available for programming the RF modem: AT Commands and Binary Commands.

IMPORTANT: For modified parameter values to persist in the RF modem's registry, changes must be saved to non-volatile memory using the WR (Write) Command. Otherwise, parameter values are restored to previously saved values the next time the RF modem is powered off and then on again.

3.5.1. AT Command Mode

Enter AT Command Mode:

1. Send the 3-character command sequence "+++" and observe guard times before and after the command characters. (Refer to "Default AT Command Mode Sequence" below.) The "Terminal" tab (or other serial communications software) of the XCTU Software can be used to enter the sequence.
(OR)
2. Assert (low) the $\overline{\text{CONFIG}}$ pin and turn the power going to the RF modem off and back on. To achieve this result, simultaneously press the Reset (Figure 1-02a) and Config (Figure 1-02c) switches; release the Reset Switch; then after 1 sec., release the Config Switch. The RF Modem then enters AT Command Mode at the modem's default baud rate.

The **AT Command Mode Sequence** (default parameter values are shown in parenthesis):

- Observe Guard Time Before (ATBT = 0x0A, no characters sent for one second)
- Enter three copies of the Command Sequence Character (ATCC = 0x2B, ASCII "+++")
- Observe Guard Time After (ATAT = 0x0A, no characters sent for one second)

To Send AT Commands:

Send AT commands and parameters using the syntax shown below:

Figure 3-08. Syntax for sending AT Commands

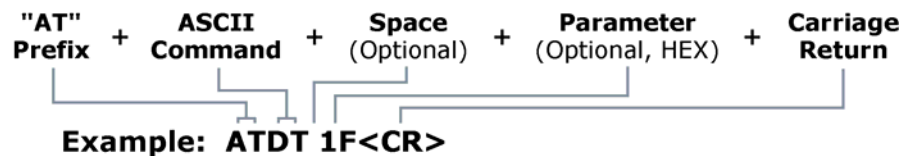

NOTE: To read a parameter value stored in a register, leave the parameter field blank.

The preceding example would change the RF modem's destination address to "1F". To store the new value to non-volatile (long term) memory, the Write (ATWR) Command must follow.

System Response. When a command is sent to the modem, the modem will parse and execute the command. Upon successful execution of a command, the modem returns an "OK" message. If execution of a command results in an error, the modem returns an "ERROR" message.

To Exit AT Command Mode:

1. Send ATCN (Exit Command Mode) Command.
(OR)
2. If no valid AT Commands are received within the time specified by CT (Command Mode Timeout) Command, the Modem automatically returns to Idle Mode.

For examples that step through the programming the modem using AT Commands, refer to the RF Modem Configuration (p20) chapter.

3.5.2. Binary Command Mode

Sending and receiving parameter values using binary commands is the fastest way to change operating parameters of the XStream RF Modem. Binary commands are used most often to sample signal strength (RS parameter) and/or error counts; or change modem addresses and channels for polling data systems. Since the sending and receiving of register values takes place through the same serial data path as “live” data (received RF payload), interference between the two types of data can be a concern.

Common questions about using binary commands:

- What are the implications of asserting CMD while live data is being sent or received?
- After sending serial data, is there a minimum time delay before CMD can be asserted?
- Is a delay required after CMD is de-asserted before payload data can be sent?
- How does one discern between live data and data received in response to a command?

The CMD pin must be asserted in order to send binary commands to the RF modem. The CMD pin can be asserted to recognize binary commands anytime during the transmission or reception of data. The status of the CMD signal is only checked at the end of the stop bit as the byte is shifted into the serial port. The application does not allow control over when data is received, except by waiting for dead time between bursts of communication.

If the command is sent in the middle of a stream of payload data to be transmitted, the command will essentially be executed in the order it is received. If the radio is continuously receiving data, the radio will wait for a break in the received data before executing the command. The $\overline{\text{CTS}}$ signal will frame the response coming from the binary command request (Figure 3-09).

A minimum time delay of 100 μs (after the stop bit of the command byte has been sent) must be observed before the CMD pin can be de-asserted. The command executes after all parameters associated with the command have been sent. If all parameters are not received within 0.5 seconds, the modem returns to Idle Mode.

Note: When parameters are sent, they are two bytes long with the least significant byte sent first. Binary commands that return one parameter byte must be written with two parameter bytes.

Refer to p21 for a binary programming example.

Commands can be queried for their current value by sending the command logically ORed (bit-wise) with the value 0x80 (hexadecimal) with CMD asserted. When the binary value is sent (with no parameters), the current value of the command parameter is sent back through the DO pin.

Figure 3-09. Binary Command Write then Read

Signal #4 is CMD

Signal #1 is the DIN signal to the radio

Signal #2 is the DOUT signal from the radio

Signal #3 is $\overline{\text{CTS}}$

In this graph, a value was written to a register and then read out to verify it. While not in the middle of other received data, note that the $\overline{\text{CTS}}$ (DO2 pin) signal outlines the data response out of the modem.

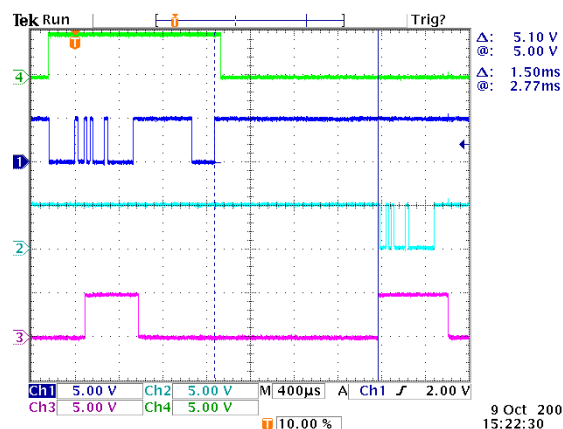

9 Oct 2002
15:22:30

IMPORTANT: For the XStream Modem to recognize a binary command, the RT (DI2 Configuration) parameter must be set to one. If binary programming is not enabled (RT \neq 1), the modem will not recognize that the CMD pin is asserted and therefore will not recognize the data as binary commands.

4. RF Modem Configuration

4.1. Hands-On Programming Examples

For more information about entering Command Mode, sending commands and exiting Command Mode, refer to the Command Mode section (p18).

Examples in this section cite the use of Digi's XCTU Software for programming the RF modem. Other programs such as Telnet Software can also be used to program the modem.

4.1.1. Configuration Setup Options

After installing the XCTU and Com Port Redirector Software (refer to p8) to a PC, use one of the connection options below to send commands to the XStream-PKG-E Ethernet RF Modem.

Option #1 – Local Network Connection

Connect a PC and the Ethernet RF Modem to active Ethernet connections of the same local network (as shown in the figure below).

Figure 4-01. Local Network Connection

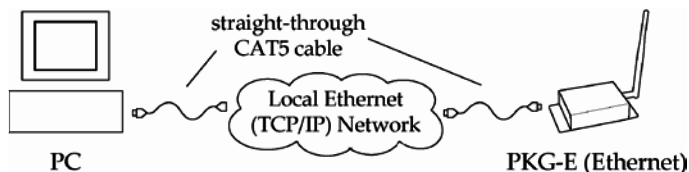

Option #2 – Direct PC Connection

Connect the Ethernet RF Modem directly to the PC through the PC's Ethernet port (as shown in the figure below).

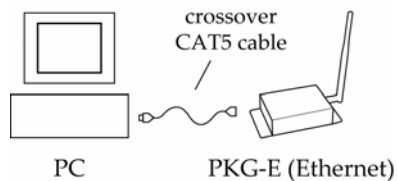

Figure 4-02. Direct PC Connection

Configuration Setup:

1. Install both the XCTU Software and the Ethernet Com Port Redirector (Refer to the "Install Software" (p8) section for more information).
2. Connect the Ethernet RF Modem to a PC using either a Local Network (p20) or a Direct PC (20) connection.
3. Follow the steps outlined in the "Ethernet RF Modem Discovery" section (p9) to identify the com port that will be used to configure the RF modem.
4. Launch the XCTU Software on the PC and select the PC Settings tab.
5. Make sure values shown in the fields of the "Com Port Setup" section match those of the Ethernet RF Modem.

(This example is continued on the following page)

4.1.2. AT Command Mode

Send AT Commands (Using the XCTU Terminal Tab):

After following the steps outlined in the Configuration Setup section (previous page), the RF modem is ready to be programmed. The following steps utilize the Terminal tab of the XCTU Software to read and write parameter values.

1. Highlight the Com Port from the “Select Com Port” list that is mapped to the Ethernet RF Modem.
2. Select the Terminal tab; then enter the following characters:

Sent AT Command	System Response
+++	OK <CR> (Enter RF modem into AT Command Mode)
ATDT <Enter>	0 <CR> (Read Current destination address)
ATDT1A0D <Enter>	OK <CR> (Change destination address to 0x1A0D)
ATWR <Enter>	OK <CR> (Write new value to non-volatile memory)
ATCN <Enter>	OK <CR> (Exit AT Command Mode)

NOTE: Multiple commands can be sent on one command line. The following command line entries will yield the same results as above. Commands must be separated by a comma (“,”).

Sent AT Command	System Response
+++	OK <CR> (Enter RF modem into AT Command Mode)
ATDT <Enter>	0 <CR> (Read Current destination address)
ATDT1A0D, WR, CN <Enter>	OK <CR> (Execute multiple commands)

Both of the preceding examples change the RF modem destination address. If the RF modem is to communicate with other RF modems, their destination addresses must match.

Send AT Commands (Using the XCTU Modem Configuration Tab):

After following the steps outlined in the Configuration Setup section (previous page), the RF modem is ready to be programmed. The following steps utilize the Modem Configuration tab of the XCTU Software to read currently stored parameter values; then restore the modem parameters to their factory-default states.

1. Highlight the Com Port from the “Select Com Port” list that is mapped to the Ethernet RF Modem.
2. Select the Modem Configuration tab.
3. Select the “Read” button. (Currently stored parameter values are displayed.)
4. Select the “Restore” button. (Original default parameter values are restored and written to the RF modem’s non-volatile memory.)

4.1.3. Binary Command Mode

Send Binary Commands:

Example: Use binary commands to change the XStream Modem’s destination address to 0x1A0D and save the new address to non-volatile memory.

1. RT Command must be set to “1” in AT Command Mode to enable binary programming.
2. Assert CMD (Pin is driven high). (Enter Binary Command Mode)
3. Send Bytes (Parameter bytes must be 2 bytes long):

00	(Send DT (Destination Address) Command)
0D	(Least significant byte of parameter bytes)
1A	(Most significant byte of parameter bytes)
08	(Send WR (Write) Command)
4. De-assert CMD (Pin is driven low). (Exit Binary Command Mode)

4.2. Command Reference Table

Table 4-01. XStream Commands as of firmware version 4.2AF

The XStream-PKG-E RF Modem expects numeric values in hexadecimal. “d” denotes decimal equivalents.

AT Command	Binary Command	AT Command Name	Range	Command Category	# Bytes Returned	Factory Default
AT	0x05 (5d)	Guard Time After	0 – 0xFFFF (x 100 msec)	AT Command Mode Options	2	0x0A (10d)
BD v4.2B*	0x15 (21d)	Interface Data Rate	Standard baud rates: 0 – 6 Non-standard baud rates: 0x7D – 0xFFFF	Serial Interfacing	2	Set to equal factory-set RF data rate
BT	0x04 (4d)	Guard Time Before	2 – 0xFFFF (x 100 msec)	AT Command Mode Options	2	0x0A (10d)
CC	0x13 (19d)	Command Sequence Character	0x20 – 0x7F	AT Command Mode Options	1	0x2B
CD v 4.2B*	0x28 (40d)	DO3 Configuration	0 - 4	Serial Interfacing	1	0
CN	0x09 (9d)	Exit AT Command Mode	-	AT Command Mode Options	-	-
CS v 4.27D*	0x1F (31d)	DO2 Configuration	0 – 4	Serial Interfacing	1	0
CT	0x06 (6d)	Command Mode Timeout	0x02 – 0xFFFF (x 100 msec)	AT Command Mode Options	2	0xC8 (200d)
DT	0x00 (0d)	Destination Address	0 – 0xFFFF	Networking	2	0
E0	0x0A (10d)	Echo Off	-	AT Command Mode Options	-	-
E1	0x0B (11d)	Echo On	-	AT Command Mode Options	-	-
ER	0x0F (15d)	Receive Error Count.	0 – 0xFFFF	Diagnostic	2	0
FH	0x0D (13d)	Force Wake-up Initializer	none	Sleep (Low Power)	-	-
FL	0x07 (7d)	Software Flow Control	0 – 1	Serial Interfacing	1	0
FT v 4.27B*	0x24 (36d)	Flow Control Threshold	0x0 – 0xFF (bytes)	Serial Interfacing	2	Varies
GD	0x10 (16d)	Receive Good Count	0 – 0xFFFF	Diagnostic	2	0
HP	0x11 (17d)	Hopping Channel	0 – 6	Networking	1	0
HT	0x03 (3d)	Time before Wake-up Initializer	0 – 0xFFFF (x 100 msec)	Sleep (Low Power)	2	0xFFFF
ID v 4.2B*	0x27 (39d)	Modem VID	User settable: 0x10 - 0x7FFF Read-only: 0x8000 – 0xFFFF	Networking	2	-
LH	0x0C (12d)	Wake-up Initializer Timer	0 – 0xFF (x 100 msec)	Sleep (Low Power)	1	1
MK	0x12 (18d)	Address Mask	0 – 0xFFFF	Networking	2	0xFFFF
PC v 4.22*	0x1E (30d)	Power-up Mode	0 – 1	AT Command Mode Options	1	0
PW v 4.22*	0x1D (29d)	Pin Wake-up	0 – 1	Sleep (Low Power)	1	0
RE	0x0E (14d)	Restore Defaults	-	(Special)	-	-
RN v 4.22*	0x19 (25d)	Delay Slots	0 – 0xFF (slots)	Networking	1	0
RO v 4.2AA*	0x21 (33d)	Packetization Timeout	0 – 0xFFFF (x 200 µsec)	Serial Interfacing	2	0x32 (50d)
RP v 4.2AA*	0x22 (34d)	RSSI PWM Timer	0 - 0x7F (x 100 msec)	Diagnostic	1	0
RR v 4.22*	0x18 (24d)	Retries	0 – 0xFF	Networking	1	0
RS v 4.22*	0x1C (28d)	RSSI	0x06 – 0x36 (Read-only)	Diagnostic	1	-
RT	0x16 (22d)	DI2 Configuration	0 - 2	Serial Interfacing	1	0
SB v4.2B*	0x36 (54d)	Stop Bits	0 – 1	Serial Interfacing	1	0
SH v 4.27C*	0x25 (37d)	Serial Number High	0 – 0xFFFF (Read-only)	Diagnostic	2	-
SL v 4.27C*	0x26 (38d)	Serial Number Low	0 – 0xFFFF (Read-only)	Diagnostic	2	-
SM	0x01 (1d)	Sleep Mode	0 – 8	Sleep (Low Power)	1	0
ST	0x02 (2d)	Time before Sleep	0x10 – 0xFFFF (x 100 msec)	Sleep (Low Power)	2	0x64 (100d)
SY	0x17 (23d)	Time before Initialization	0 – 0xFF (x 100 msec)	Networking	1	0 (disabled)
TR v 4.22*	0x1B (27d)	Transmit Error Count	0 – 0xFFFF	Diagnostic	2	0
TT v 4.22*	0x1A (26d)	Streaming Limit	0 – 0xFFFF (0 = disabled)	Networking	2	0xFFFF
VR	0x14 (20d)	Firmware Version	0 x 0xFFFF (Read-only)	Diagnostic	2	-
WR	0x08 (8d)	Write	-	(Special)	-	-

* Firmware version in which the command and parameter options were first supported.

NOTE: Commands issued without a parameter value will return the currently stored parameter.

4.3. Command Descriptions

Commands in this section are listed alphabetically. Command categories are designated between the “< >” symbols that follow each command title. XStream Modems expect numerical values in hexadecimal and those values are designated by a “0x” prefix.

AT (Guard Time After) Command

<Command Mode Options> AT Command is used to set the time-of-silence that follows the command sequence character (CC Command). By default, AT Command Mode will activate after one second of silence.

Refer to the AT Command Mode section to view the default AT Command Mode Sequence.

AT Command: ATAT
Binary Command: 0x05 (5 decimal)
Parameter Range: 0x02 – 0xFFFF
(x 100 milliseconds)
Number of bytes returned: 2
Default Parameter Value: 0x0A (10 decimal)
Related Commands: BT (Guard Time Before), CC (Command Sequence Character)

BD (Interface Data Rate) Command

<Serial Interfacing> BD Command allows the user to adjust the UART I/O serial data rate and thus modify the rate at which serial data is sent to the modem. The new baud rate does not take effect until the CN (Exit AT Command Mode) Command is issued. Throughput and RF data rates are not affected by the BD Command.

Although most applications will only require one of the seven standard baud rates, non-standard baud rates are also supported.

Note: If the serial data rate is set to exceed the fixed RF data rate of the XStream modem, CTS flow control may need to be implemented as described in the Pin Signals and Flow Control sections of this manual.

Non-standard Interface Data Rates: When parameter values outside the range of standard baud rates are sent, the closest interface data rate represented by the number is stored in the BD register. For example, a rate of 19200 bps can be set by sending the following command line "ATBD4B00". NOTE: When using Digi's XCTU Software, non-standard interface data rates can only be set and read using the XCTU "Terminal" tab. Non-standard rates are not accessible through the "Modem Configuration" tab.

When the BD command is sent with a non-standard interface data rate, the UART will adjust to accommodate the requested interface rate. In most cases, the clock resolution will cause the stored BD parameter to vary from the parameter that was sent (refer to the table below). Reading the BD command (send "ATBD" command without an associated parameter value) will return the value that was actually stored to the BD register.

Table 4-02. Parameter Sent vs. Parameter Stored

BD Parameter Sent (HEX)	Interface Data Rate (bps)	BD Parameter Stored (HEX)
0	1200	0
4	19,200	4
7	115,200	7
12C	300	12B
1C200	115,200	1B207

AT Command: ATBD
Binary Command: 0x15 (21 decimal)
Parameter Range (Standard baud rates): 0 – 6
(Non-standard baud rates): 0x7D – 0xFFFF

Parameter	BAUD (bps) Configuration
0	1200
1	2400
2	4800
3	9600
4	19200
5	38400
6	57600

Number of bytes returned: 2
Default Parameter Value: Set to equal modem's factory-set RF data rate.
Minimum firmware version required: 4.2B
(custom baud rates not previously supported)

BT (Guard Time Before) Command

<Command Mode Options> BT Command is used to set the DI pin silence time that must precede the command sequence character (CC Command) of the AT Command Mode Sequence.

Refer to the AT Command Mode section to view the default AT Command Mode Sequence.

AT Command: ATBT

Binary Command: 0x04 (4 decimal)

Parameter Range: 2 – 0xFFFF
(x 100 milliseconds)

Default Parameter Value: 0x0A (10 decimal)

Number of bytes returned: 2

Related Commands: AT (Guard Time After), CC (Command Sequence Character)

CC (Command Sequence Character) Command

<Command Mode Options> The CC Command is used to set the ASCII character used between Guard Times of the AT Command Mode Sequence (BT + CC + AT). The AT Command Mode Sequence activates AT Command Mode.

Refer to the AT Command Mode section to view the default AT Command Mode Sequence.

AT Command: ATCC

Binary Command: 0x13 (19 decimal)

Parameter Range: 0x20 – 0x7F

Default Parameter Value: 0x2B (ASCII “+” sign)

Number of bytes returned: 1

Related Commands: AT (Guard Time After), BT (Guard Time Before)

CD (DO3 Configuration) Command

<Command Mode Options> CD Command is used to redefine the behavior of the DO3/RX LED line.

AT Command: ATCD

Binary Command: 0x28 (40 decimal)

Parameter Range: 0 – 2

Parameter	Configuration
0	RX LED
1	Default high
2	Default low
3	(reserved)
4	Assert only when packet addressed to module sent

Default Parameter Value: 0

Number of bytes returned: 1

Minimum Firmware Version Required: 4.2B

CN (Exit AT Command Mode) Command

<Command Mode Options> CN Command is used to explicitly exit AT Command Mode.

AT Command: ATCN

Binary Command: 0x09 (9 decimal)

CS (DO2 Configuration) Command

<Serial Interfacing> CS Command is used to select the behavior of the DO2 pin signal. This output can provide RS-232 flow control, control the TX enable signal (for RS-485 or RS-422 operations), or set the default level for the I/O line passing function.

By default, DO2 provides RS-232 $\overline{\text{CTS}}$ (Clear-to-Send) flow control.

AT Command: ATCS

Binary Command: 0x1F (31 decimal)

Parameter Range: 0 – 4

Parameter	Configuration
0	RS-232 $\overline{\text{CTS}}$ flow control
1	RS-485 TX enable low
2	high
3	RS-485 TX enable high
4	low

Default Parameter Value: 0

Number of bytes returned: 1

Related Commands: RT (DI2 Configuration), TO (DO2 Timeout)

Minimum Firmware Version Required: 4.27D

CT (Command Mode Timeout) Command

<Command Mode Options> CT Command sets the amount of time before AT Command Mode terminates automatically. After a CT time of inactivity, the modem exits AT Command Mode and returns to Idle Mode. AT Command Mode can also be exited manually using CN (Exit AT Command Mode) Command.

AT Command: ATCT
 Binary Command: 0x06 (6 decimal)
 Parameter Range: 0x02 – 0xFFFF
 (x 100 milliseconds)
 Default Parameter Value: 0xC8 (200 decimal,
 20 seconds)
 Number of bytes returned: 2

DT (Destination Address) Command

<Networking> DT Command is used to set the networking address of an XStream Modem. XStream Modems uses three network layers – Vendor Identification Number (ATID), Channels (ATHP), and Destination Addresses (ATDT). DT Command assigns an address to a modem that enables it to communicate only with other modems having the same addresses. All modems that share the same Destination Address can communicate freely with each other. Modems in the same network with a different Destination Address (than that of the transmitter) will listen to all transmissions to stay synchronized, but will not send any of the data out their serial ports.

AT Command: ATDT
 Binary Command: 0x00
 Parameter Range: 0 – 0xFFFF
 Default Parameter Value: 0
 Number of bytes returned: 2
 Related Commands: HP (Hopping Channel), ID (Modem VID), MK (Address Mask)

E0 (Echo Off) Command

<Command Mode Options> E0 Command turns off character echo in AT Command Mode. By default, echo is off.

AT Command: ATE0
 Binary Command: 0x0A (10 decimal)

E1 (Echo On) Command

<Command Mode Options> E1 Command turns on the echo in AT Command Mode. Each typed character will be echoed back to the terminal when ATE1 is active. E0 is the default.

AT Command: ATE1
 Binary Command: 0x0B (11 decimal)

ER (Receive Error Count) Command

<Diagnostics> Set/Read the receive-error. The error-count records the number of packets partially received then aborted on a reception error. This value returns to 0 after a reset and is not non-volatile (Value does not persist in the modem's memory after a power-up sequence). Once the "Receive Error Count" reaches its maximum value (up to 0xFFFF), it remains at its maximum count value until the maximum count value is explicitly changed or the modem is reset.

AT Command: ATER
 Binary Command: 0x0F (15 decimal)
 Parameter Range: 0 – 0xFFFF
 Default Parameter Value: 0
 Number of bytes returned: 2
 Related Commands: GD (Receive Good Count)

FH (Force Wake-up Initializer) Command

<Sleep (Low Power) > FH Command is used to force a Wake-up Initializer to be sent on the next transmit. WR (Write) Command does not need to be issued with FH Command.

AT Command: ATFH
 Binary Command: 0x0D (13 decimal)

Use only with cyclic sleep modes active on remote modems.

FL (Software Flow Control) Command

<Serial Interfacing> FL Command is used to configure software flow control. Hardware flow control is implemented with the XStream Modem as the DO2 pin ($\overline{\text{CTS}}$), which regulates when serial data can be transferred to the modem. FL Command can be used to allow software flow control to also be enabled. XON character used is 0x11 (17 decimal). XOFF character used is 0x13 (19 decimal).

AT Command: ATFL
Binary Command: 0x07 (7 decimal)

Parameter Range: 0 – 1

Parameter	Configuration
0	Disable software flow control
1	Enable software flow control

Default Parameter Value: 0
Number of bytes returned: 1

FT (Flow Control Threshold) Command

<Serial Interfacing> Set/Read the flow control threshold. When FT bytes have accumulated in the DI buffer, $\overline{\text{CTS}}$ is de-asserted or the XOFF software flow control character is transmitted.

AT Command: ATFT
Binary Command: 0x24 (36 decimal)

Parameter Range: 0 – (Receiving modem DO buffer size minus 0x11 bytes)

Default Parameter Value: Receiving modem DO Buffer size minus 0x11

Number of bytes returned: 2

Minimum Firmware Version Required: 4.27B

GD (Receive Good Count) Command

<Diagnostics> Set/Read the count of good received RF packets. Parameter value is reset to 0 after every reset and is not non-volatile (Value does not persist in the modem's memory after a power-up sequence). Once the "Receive Good Count" reaches its maximum value (up to 0xFFFF), it remains at its maximum count value until the maximum count value is manually changed or the modem is reset.

AT Command: ATGD
Binary Command: 0x10 (16 decimal)

Parameter Range: 0 – 0xFFFF

Default Parameter Value: 0

Number of bytes returned: 2

Related Commands: ER (Receive Error Count)

HP (Hopping Channel) Command

<Networking> HP Command is used to set the modem's hopping channel number. A channel is one of three layers of addressing available to the XStream modem. In order for modems to communicate with each other, the modems must have the same channel number since each network uses a different hopping sequence. Different channels can be used to prevent modems in one network from listening to transmissions of another.

AT Command: ATHP
Binary Command: 0x11 (17 decimal)

Parameter Range: 0 – 6

Default Parameter Value: 0

Number of bytes returned: 1

Related Commands: DT (Destination Address), ID (Modem VID), MK (Address Mask)

HT (Time before Wake-up Initializer) Command

<Sleep (Low Power)> If any modems within range are running in a “Cyclic Sleep” setting, a wake-up initializer must be used by the transmitting modem for sleeping modems to remain awake (refer to the LH (“Wake-up Initializer Timer”) Command). When a receiving modem in Cyclic Sleep wakes, it must detect the wake-up initializer in order to remain awake and receive data. The value of HT Parameter tells the transmitter, “After a period of inactivity (no transmitting or receiving) lasting HT amount of time, send a long wake-up initializer”. HT Parameter should be set to match the inactivity timeout (specified by ST (Time before Sleep) Command) used by the receiver(s).

From the receiving modem perspective, after HT time elapses and the inactivity timeout (ST Command) is met, the receiver goes into cyclic sleep. In cyclic sleep, the receiver wakes once per sleep interval to check for a wake-up initializer. When a wake-up initializer is detected, the modem will stay awake to receive data. The wake-up initializer must be longer than the cyclic sleep interval to ensure that sleeping modems detect incoming data. When HT time elapses, the transmitter then knows that it needs to send a long Wake-up Initializer for all receivers to be able to remain awake and receive the next transmission. Matching HT to the time specified by ST on the receiving modem guarantees that all receivers will detect the next transmission.

AT Command: ATHT

Binary Command: 0x03 (3 decimal)

Parameter Range: 0 – 0xFFFF
(x 100 milliseconds)

Default Parameter Value: 0xFFFF (means that long wake-up initializer will not be sent)

Number of bytes returned: 2

Related Commands: LH (Wake-up Initializer Timer), SM (Sleep Mode), ST (Time before Sleep)

ID (Modem VID) Command

<Networking> Read the modem’s VID. VID is a Digi-specific acronym that stands for “Vendor Identification Number”. This number is factory-set and allows modems with matching VIDs to communicate. Modems with non- matching VIDs will not receive unintended data transmission.

AT Command: ATID

Binary Command: 0x27 (39 decimal)

Parameter Range (user-settable):
0x10 – 0x7FFFF
(Factory-set and read-only):
0x8000 – 0xFFFF

Number of bytes returned: 2

Minimum Firmware Version Required: 4.2B
(Previous versions did not support user-settable VIDs)

LH (Wake-up Initializer Timer) Command

<Sleep (Low Power)> LH Command adjusts the duration of time for which the RF initializer is sent. When receiving modems are put into Cyclic Sleep Mode, they power-down after a period of inactivity (specified by ST (Time before Sleep) Command) and will periodically awaken and listen for transmitted data. In order for the receiving modems to remain awake, they must detect ~35ms of the wake-up initializer.

AT Command: ATLH

Binary Command: 0x0C (12 decimal)

Parameter Range: 0 – 0xFF
(x 100 milliseconds)

Default Parameter Value: 1

Number of bytes returned: 1

Related Commands: HT (Time before Wake-up Initializer), SM (Sleep Mode), ST (Time before Sleep)

LH Command must be used whenever a receiver is operating in Cyclic Sleep Mode. This lengthens the Wake-up Initializer to a specific amount of time (in tenths of a second). The Wake-up Initializer Time must be longer than the cyclic sleep time that is determined by SM (Sleep Mode) Command. If the wake-up initializer time were less than the Cyclic Sleep interval, the connection would be at risk of missing the wake-up initializer transmission.

Refer to Figures 4-03 and 4-04 of the SM Command description to view diagrams of correct and incorrect configurations. The images help visualize the importance that the value of LH be greater than the value of SM.

MK (Address Mask) Command

<Networking> MK Command is used to set/read the Address Mask.

All data packets contain the Destination Address of the transmitting modem. When an RF data packet is received, the transmitter's Destination Address is logically "ANDed" (bitwise) with the Address Mask of the receiver. The resulting value must match the Destination Address or the Address Mask of the receiver for the packet to be received and sent out the modem's DO serial port. If the "ANDed" value does not match either the Destination Address or the Address Mask of the receiver, the packet is discarded. (All "0" values are treated as "irrelevant" values and are ignored.)

AT Command: ATMK
 Binary Command: 0x12 (18 decimal)
 Parameter Range: 0 - 0xFFFF
 Default Parameter Value: 0xFFFF
 (Destination address (DT parameter) of the transmitting modem must exactly match the destination address of the receiving modem.)
 Number of bytes returned: 2
 Related Commands: DT (Destination Address), HP (Hopping Channel), ID (Modem VID), MY (Source Address)

NB (Parity) Command

<Serial Interfacing> Select/Read parity settings for UART communications.

AT Command: ATNB
 Binary Command: 0x23 (35 decimal)
 Parameter Range: 0 - 4

Parameter	Configuration
0	8-bit (no parity or 7-bit (any parity))
1	8-bit even
2	8-bit odd
3	8-bit mark
4	8-bit space

Default Parameter Value: 0
 Number of bytes returned: 1
 Minimum Firmware Version Required: 4.27B

PC (Power-up to AT Mode) Command

<Command Mode Options> PC Command allows the modem to power-up directly into AT Command Mode from reset or power-on. If PC Command is enabled with SM Parameter set to 1, the DI3 Pin (SLEEP) can be used to enter the modem into AT Command Mode. When the DI3 pin is de-asserted (low), the modem will Wake-up into AT Command Mode. This behavior allows modem DTR emulation.

AT Command: ATPC
 Binary Command: 0x1E (30 decimal)
 Parameter Range: 0 - 1

Parameter	Configuration
0	Power-up to Idle Mode
1	Power-up to AT Command Mode

Default Parameter Value: 0
 Number of bytes returned: 1
 Minimum Firmware Version Required: 4.22

PW (Pin Wake-up) Command

<Sleep (Low Power)> Under normal operation, a modem in Cyclic Sleep Mode cycles from an active state to a low-power state at regular intervals until data is ready to be received. If the PW Parameter is set to 1, the SLEEP/DI3 Pin can be used to awaken the modem from Cyclic Sleep. If the SLEEP Pin is de-asserted (low), the modem will be fully operational and will not go into Cyclic Sleep. Once SLEEP is asserted, the modem will remain active for the period of time specified by ST (Time before Sleep) Command, and will return to Cyclic Sleep Mode (if no data is ready to be transmitted). PW Command is only valid if Cyclic Sleep has been enabled.

AT Command: ATPW

Binary Command: 0x1D (29 decimal)

Parameter Range: 0 – 1

Parameter	Configuration
0	Disabled
1	Enabled

Default Parameter Value: 0

Number of bytes returned: 1

Related Commands: SM (Sleep Mode), ST (Time before Sleep)

Minimum Firmware Version Required: 4.22

RE (Restore Defaults) Command

<Diagnostics> RE Command restores all configurable parameters to factory default settings. However, RE Command will not write the default values to non-volatile (persistent) memory. Unless the WR (Write) Command is issued after the RE command, the default settings will not be saved in the event of modem reset or power-down.

AT Command: ATRE

Binary Command: 0x0E (14 decimal)

RN (Delay Slots) Command

<Networking> RN Command is only applicable if retries have been enabled (RR (Retries) Command), or if forced delays will be inserted into a transmission (see TT (Streaming Limit) Command). RN Command is used to adjust the time delay that the transmitter inserts before attempting to resend a packet. If the transmitter fails to receive an acknowledgement after sending a packet, it will insert a random number of delay slots (ranging from 0 to (RN minus 1)) before attempting to resend the packet. Each delay slot lasts for a period of 38ms.

If two modems attempted to transmit at the same time, the random time delay after packet failure would allow one of the two modems to transmit the packet successfully, while the other would wait until the channel opens up to begin transmission.

AT Command: ATRN

Binary Command: 0x19 (25 decimal)

Parameter Range: 0 – 0xFF (slots)

Default Parameter Value: 0 (no delay slots inserted)

Number of bytes returned: 1

Related Commands: RR (Retries), TT (Streaming Limit)

Minimum Firmware Version Required: 4.22

RO (Packetization Timeout) Command

<Serial Interfacing> RO Command is used to specify/read the time of silence (no bytes received) after which transmission begins. After a serial byte is received and if no other byte is received before the RO timeout, the transmission will start.

AT Command: ATRO

Binary Command: 0x21 (33 decimal)

Parameter Range: 0 – 0xFFFF (x 200 μs)

Default Parameter Value: 0

Number of bytes returned: 2

Minimum Firmware Version Required: 4.2AA

RP (RSSI PWM Timer) Command

<Diagnostics> RP Command is used to enable a PWM (“Pulse Width Modulation”) output on the Config pin which is calibrated to show the level the received RF signal is above the sensitivity level of the modem. The PWM pulses vary from zero to 95 percent. Zero percent means the received RF signal is at or below the published sensitivity level of the modem. The following table shows levels above sensitivity and PWM values.

The total period of the PWM output is 8.32 ms. There are 40 steps in the PWM output and therefore the minimum step size is 0.208 ms.

dBm above Sensitivity	PWM percentage (high period / total period)
10	47.5
20	62.5
30	77.5

A non-zero value defines the time that the PWM output will be active with the RSSI value of the last received RF packet. After the set time when no RF packets are received, the PWM output will be set low (0 percent PWM) until another RF packet is received. The PWM output will also be set low at power-up. A parameter value of 0xFF permanently enables the PWM output and it will always reflect the value of the last received RF packet.

PWM output shares the Config input pin. When the modem is powered, the Config pin will be an input. During the power-up sequence, the Config pin will be read to determine whether the modem is going into AT Command Mode. After this, if RP parameter is a non-zero value, the Config pin will be configured as an output and set low until the first RF packet is received. With a non-zero RP parameter, the Config pin will be an input for RP ms after power up.

RR (Retries) Command

Networking> RR Command specifies the number of retries that can be sent for a given RF packet. Once RR Command is enabled (set to a non-zero value), RF packet acknowledgements and retries are enabled. After transmitting a packet, the transmitter will wait to receive an acknowledgement from a receiver. If the acknowledgement is not received in the period of time specified by the RN (Delay Slots) Command, the transmitter will transmit the original packet again. The packet will be transmitted repeatedly until an acknowledgement is received or until the packet has been sent RR times.

Note: For retries to work correctly, all modems in the system must have retries enabled.

RS (RSSI) Command

<Diagnostics> RS Command returns the signal level of the last packet received. This reading is useful for determining range characteristics of the XStream Modems under various conditions of noise and distance.

Once the command is issued, the modem will return a value between 0x6 and 0x36 where 0x36 represents a very strong signal level and 0x4 indicates a low signal level.

- AT Command: ATRP
- Binary Command: 0x22 (34 decimal)
- Parameter Range: 0 – 0x7F (x 100 milliseconds)
- Default Parameter Value: 0 (disabled)
- Number of bytes returned: 1
- Minimum Firmware Version Required: 4.2AA

- AT Command: ATRR
- Binary Command: 0x18 (24 decimal)
- Parameter Range: 0 – 0xFF
- Default Parameter Value: 0 (disabled)
- Number of bytes returned: 1
- Minimum Firmware Version Required: 4.22

- AT Command: ATRS
- Binary Command: 0x1C (28 decimal)
- Parameter Range: 0x06 – 0x36 (Read-only)
- Number of bytes returned: 1
- Minimum Firmware Version Required: 4.22

RT (DI2 Configuration) Command

<Serial Interfacing> RT command is used to dictate the behavior of the DI2/RTS/CMD line. RT Command must be issued to enable RTS flow control or binary programming.

Binary Command: 0x16 (22 decimal)

Parameter Range: 0 - 2

Parameter	Configuration
0	disabled
1	Enable Binary Programming
2	Enable RTSFlow Control

Default Parameter Value: 0

Number of bytes returned: 1

SB (Stop Bits) Command

SB Command is used to set/read the number of stop bits in the data packets.

AT Command: ATSB

Binary Command: 0x36 (54 decimal)

Parameter Range: 0 - 1

Parameter Value	Configuration
0	1 stop bits
1	2 stop bits

Default Parameter Value: 0

Number of bytes returned: 1

Minimum Firmware Version Required: 4.2B

SH (Serial Number High) Command

<Diagnostics> Set/Read the serial number high word of the modem.

AT Command: ATSH

Binary Command: 0x25 (37 decimal)

Parameter Range: 0 - 0xFFFF (Read-only)

Number of bytes returned: 2

Related Commands: SL (Serial Number Low)

Minimum Firmware Version Required: 4.27C

SL (Serial Number Low) Command

<Diagnostics> Set/Read the serial number low word of the modem.

AT Command: ATSL

Binary Command: 0x26 (38 decimal)

Parameter Range: 0 - 0xFFFF (Read-only)

Number of bytes returned: 2

Related Commands: SH (Serial Number High)

Minimum Firmware Version Required: 4.27C

SM (Sleep Mode) Command

<Sleep Mode (Low Power)> SM Command is used to adjust Sleep Mode settings. By default, Sleep Mode is disabled and the modem remains continually active. SM Command allows the modem to run in a lower-power state and be configured in one of eight settings.

Cyclic Sleep settings wake the modem after the amount of time designated by SM Command. If the modem detects a wake-up initializer during the time it is awake, it will synchronize with the transmitter and start receiving data after the wake-up initializer runs its duration. Otherwise, it returns to Sleep Mode and continue to cycle in and out of inactivity until the Wake-up Initializer is detected. If a Cyclic Sleep setting is chosen, the ST, LH and HT parameters must also be set as described in the “Sleep Mode” section of this manual.

AT Command: ATSM

Binary Command: 0x01

Parameter Range: 0 – 8

Parameter	Configuration
0	Disabled
1	Pin Sleep
2	Serial Port Sleep
3	Cyclic 0.5 second sleep (Modem wakes every 0.5 seconds)
4	Cyclic 1.0 second sleep
5	Cyclic 2.0 second sleep
6	Cyclic 4.0 second sleep
7	Cyclic 8.0 second sleep
8	Cyclic 16.0 second sleep

Default Parameter Value: 0

Number of bytes returned: 1

Related Commands:

For Pin Sleep – PC (Power-up Mode), PW (Pin Wake-up)

For Serial Port Sleep – ST (Time before Sleep)

For Cyclic Sleep – ST (Time before Sleep), LH (Wake-up Initializer Timer), HT (Time Before Wake-up Initializer), PW (Pin Wake-up)

ST (Time before Sleep) Command

<Sleep Mode (Low Power)> ST Command sets the period of time (in tenths of seconds) in which the modem remains inactive before entering into Sleep Mode. For example, if the ST Parameter is set to 0x64 (100 decimal), the modem will enter into Sleep mode after 10 seconds of inactivity (no transmitting or receiving). This command can only be used if Cyclic Sleep or Serial Port Sleep Mode settings have been selected using SM (Sleep Mode) Command.

AT Command: ATST

Binary Command: 0x02

Parameter Range: 0x10 – 0xFFFF
(x 100 milliseconds)

Default Parameter Value: 0x64 (100 decimal)

Number of bytes returned: 2

Related Commands: SM (Sleep Mode), LH (Wake-up Initializer Timer), HT (Time before Wake-up Initializer)

SY (Time before Initialization) Command

<Networking> SY Command keeps a communication channel open as long as modem transmits or receives before the active connection expires. It can be used to reduce latency in a query/response sequence and should be set 100 ms longer than the delay between transmissions.

This command allows multiple XStream Modems to share a hopping channel for a given amount of time after receiving data. By default, all packets include an RF initializer that contains channel information used to synchronize any listening receivers to the transmitter's hopping pattern. Once a new modem comes within range or is powered on within range, it is able to instantly synchronize to the transmitter and start receiving data. If no new modems are introduced into the system, the synchronization information becomes redundant once modems have become synchronized.

AT Command: ATSY

Binary Command: 0x17 (23 decimal)

Parameter Range: 0 – 0xFF
(x 100 milliseconds)

Default Parameter Value: 0 (Disabled – channel initialization information is sent with each RF packet.)

Number of bytes returned: 1

SY Command allows the modems to remove this information from the RF Initializer after the initial synchronization. For example, changing the SY Parameter to 0x14 (20 decimal) allows all modems to remain in sync for 2 seconds after the last data packet was received. Synchronization information is not re-sent unless transmission stops for more than 2 seconds. This command allows significant savings in packet transmission time.

Warning: Not recommended for use in an interference-prone environment. Interference can break up the session and the communications channel will not be available again until SY time expires.

With SY set to zero, the channel session is opened and closed with each transmission - resulting in a more robust link with more latency.

TR (Transmit Error Count) Command

<Diagnostics> TR Command records the number of retransmit failures. This number is incremented each time a packet is not acknowledged within the number of retransmits specified by the RR (Retries) Command. It therefore counts the number of packets that were not successfully received and have been dropped.

The TR Parameter is not non-volatile and will therefore be reset to zero each time the modem is reset.

AT Command: ATTR

Binary Command: 0x1B (27 decimal)

Parameter Range: 0 – 0xFFFF

Default Parameter Value: 0

Number of bytes returned: 2

Related Commands: RR (Retries)

Minimum Firmware Version Required: 4.22

TT (Streaming Limit) Command

<Networking> TT Command defines a limit on the number of bytes that can be sent out before a random delay is issued. TT Command is used to simulate full-duplex behavior.

If a modem is sending a continuous stream of RF data, a delay is inserted which stops its transmission and allows other modems time to transmit (once it sends number of bytes specified by TT Command). Inserted random delay lasts between 1 and "RN + 1" delay slots, where each delay slot lasts 38ms.

AT Command: ATTT

Binary Command: 0x1A (26 decimal)

Parameter Range: 0 – 0xFFFF (0 = disabled)

Default Parameter Value: 0xFFFF (65535 decimal)

Number of bytes returned: 2

Related Commands: RN (Delay Slots)

Minimum Firmware Version Required: 4.22

VR (Firmware Version) Command

<Diagnostics> Read the Firmware Version of the XStream Modem.

AT Command: ATVR

Binary Command: 0x14 (20 decimal)

Parameter Range: 0 – 0xFFFF (Read-only)

Number of bytes returned: 2

WR (Write) Command

<(Special)> WR Command writes configurable parameters to the modem's non-volatile memory (Parameter values remain in the modem's memory until overwritten by future use of WR Command).

If changes are made without writing them to non-volatile memory, the modem reverts back to previously saved parameters the next time the modem is powered-on.

AT Command: ATWR

Binary Command: 0x08

Appendix A: Agency Certifications

FCC Certification

The XStream RF Modem complies with Part 15 of the FCC rules and regulations. Compliance with the labeling requirements, FCC notices and antenna usage guidelines is required.

To fulfill the FCC Certification requirements, the OEM must comply with the following FCC regulations:

1. The system integrator must ensure that the text on the external label provided with this device is placed on the outside of the final product (Figure A-01 for 900 MHz operations or Figure A-02 for 2.4 GHz operations).
2. The XStream RF Modem may be used only with Approved Antennas that have been tested with this modem. (Table A-01 or Table A-02)

FCC Notices

IMPORTANT: The 9XStream (900 MHz) and 24XStream (2.4 GHz) RF Modems have been certified by the FCC for use with other products without any further certification (as per FCC section 2.1091). Changes or modifications not expressly approved by Digi could void the user's authority to operate the equipment.

IMPORTANT: OEMs must test their final product to comply with unintentional radiators (FCC section 15.107 and 15.109) before declaring compliance of their final product to Part 15 of the FCC Rules.

IMPORTANT: The XStream RF Modems have been certified for remote and base radio applications. If the XStream will be used for portable applications, the device must undergo SAR testing.

This equipment has been tested and found to comply with the limits for a Class B digital device, pursuant to Part 15 of the FCC Rules. These limits are designed to provide reasonable protection against harmful interference in a residential installation. This equipment generates, uses and can radiate radio frequency energy and, if not installed and used in accordance with the instructions, may cause harmful interference to radio communications. However, there is no guarantee that interference will not occur in a particular installation. If this equipment does cause harmful interference to radio or television reception, which can be determined by turning the equipment off and on, the user is encouraged to try to correct the interference by one or more of the following measures:

- Re-orient or relocate the receiving antenna.
- Increase the separation between the equipment and receiver.
- Connect the equipment into an outlet on a circuit different from that to which the receiver is connected.
- Consult the dealer or an experienced radio/TV technician for help.

OEM Labeling Requirements

Label Warning

 **WARNING** The Original Equipment Manufacturer (OEM) must ensure that FCC labeling requirements are met. This includes a clearly visible label on the outside of the final product enclosure that displays the contents shown in the figure below.

Figure A-01. Required FCC Label for OEM products containing 9XStream (900 MHz) RF Modem

Contains FCC ID: OUR9XSTREAM
The enclosed device complies with Part 15 of the FCC Rules. Operation is subject to the following two conditions: (1) this device may not cause harmful interference and (2) this device must accept any interference received, including interference that may cause undesired operation.

Figure A-02. Required FCC Label for OEM products containing 24XStream (2.4 GHz) RF Modem

Contains FCC ID: OUR-24XSTREAM
The enclosed device complies with Part 15 of the FCC Rules. Operation is subject to the following two conditions: (1) this device may not cause harmful interference and (2) this device must accept any interference received, including interference that may cause undesired operation.

Antenna Usage

Antenna Warning

 **WARNING:** This device has been tested with Reverse Polarity SMA connectors with the antennas listed in Table A-01 and Table A-02 of Appendix A. When integrated in OEM products, fixed antennas require installation preventing end-users from replacing them with non-approved antennas. Antennas not listed in the tables must be tested to comply with FCC Section 15.203 (unique antenna connectors) and Section 15.247 (emissions).

RF Exposure

 **WARNING:** This equipment is approved only for mobile and base station transmitting devices, separation distances of (i) 20 centimeters or more for antennas with gains < 6 dBi or (ii) 2 meters or more for antennas with gains \geq 6 dBi should be maintained between the antenna of this device and nearby persons during operation. To ensure compliance, operation at distances closer than this is not recommended.

The preceding statement must be included as a CAUTION statement in manuals for OEM products to alert users of FCC RF Exposure compliance.

Digi radio modems are pre-FCC approved for use in fixed base station and mobile applications. As long as the antenna is mounted at least 20 cm (8 in) from nearby persons, the application is considered a mobile application. If the antenna will be mounted closer than 20 cm to nearby persons, then the application is considered “portable” and requires an additional test performed on the final product. This test is called the Specific Absorption Rate (SAR) testing and measures the emissions from the radio modem and how they affect the person.

Over 100 additional antennas have been tested and are approved for use with Digi 900 MHz Radio Modems (including “Mag Mount”, “Dome”, “Multi-path” and “Panel” antennas). Because of the large number of approved antennas, Digi requests that you send specific information about an antenna you would like to use with the modem and Digi will evaluate whether the antenna is covered under our FCC filing.

FCC Approved Antennas

Table A-01. Antennas approved for use with 9XStream (900 MHz) RF Modems.

Manufacturer	Part Number	Type	Gain	Application	Min. Separation Distance
*	*	Yagi	6.2 dBi	Fixed/Mobile **	20 cm
*	*	Yagi	7.2 dBi	Fixed/Mobile **	20 cm
Digi	A09-Y8	Yagi	8.2 dBi	Fixed/Mobile **	20 cm
*	*	Yagi	9.2 dBi	Fixed/Mobile **	20 cm
*	*	Yagi	10.2 dBi	Fixed/Mobile **	20 cm
Digi	A09-Y11 (FCC pending)	Yagi	11.2 dBi	Fixed/Mobile **	20 cm
Digi	A09-F2	Omni Direct.	2.2 dBi	Fixed **	20 cm
Digi	A09-F5	Omni Direct.	5.2 dBi	Fixed **	20 cm
Digi	A09-F8	Omni Direct.	8.2 dBi	Fixed **	20 cm
*	*	Omni Direct.	9.2 dBi	Fixed **	20 cm
*	*	Omni Direct.	7.2 dBi	Fixed **	20 cm
Digi	A09-M7	Omni Direct.	7.2 dBi	Fixed **	20 cm
Digi	A09-H	1/2 wave antenna	2.1 dBi	Fixed/Mobile **	20 cm
Digi	A09-HBMM-P5I	1/2 wave antenna	2.1 dBi	Fixed/Mobile **	1 cm
Digi	A09-QBMM-P5I	1/4 wave antenna	1.9 dBi	Fixed/Mobile **	1 cm
*	*	1/4 wave integrated wire antenna	1.9 dBi	Fixed/Mobile **	1 cm

Table A-02. Antennas approved for use with 24XStream (2.4 GHz) RF Modems.

Manufacturer	Part Number	Type	Gain	Application	Min. Separation Distance
*	*	Yagi	6 dBi	Fixed **	2 m
*	*	Yagi	8.8 dBi	Fixed **	2 m
*	*	Yagi	9 dBi	Fixed **	2 m
*	*	Yagi	10 dBi	Fixed **	2 m
*	*	Yagi	11 dBi	Fixed **	2 m
*	*	Yagi	12 dBi	Fixed **	2 m
*	*	Yagi	12.5 dBi	Fixed **	2 m
*	*	Yagi	13.5 dBi	Fixed **	2 m
*	*	Yagi	15 dBi	Fixed **	2 m
*	*	Omni Direct	2.1 dBi	Fixed/Mobile **	20 cm
*	*	Omni Direct	3 dBi	Fixed/Mobile **	20 cm
*	*	Omni Direct	5 dBi	Fixed/Mobile **	20 cm
*	*	Omni Direct	7.2 dBi	Fixed **	2 m
*	*	Omni Direct	8 dBi	Fixed **	2 m
*	*	Omni Direct	9.5 dBi	Fixed **	2 m
*	*	Omni Direct	10 dBi	Fixed **	2 m
*	*	Omni Direct	12 dBi	Fixed **	2 m
*	*	Omni Direct	15 dBi	Fixed **	2 m
Digi	A24-P8	Panel	8.5 dBi	Fixed **	2 m
Digi	A24-P13	Panel	13 dBi	Fixed **	2 m
*	*	Panel	14 dBi	Fixed **	2 m
*	*	Panel	15 dBi	Fixed **	2 m
*	*	Panel	16 dBi	Fixed **	2 m
Digi	A24-P19	Panel	19 dBi	Fixed **	2 m
Digi	A24-HABMM-P6I	Dipole	2.1 dBi	Fixed/Mobile **	20 cm
Digi	A24-HBMM-P6I	Dipole	2.1 dBi	Fixed/Mobile **	20 cm
Digi	A24-HABSM	Dipole	2.1 dBi	Fixed/Mobile **	20 cm
Digi	A24-QABMM-P6I	Monopole	1.9 dBi	Fixed/Mobile **	20 cm
*	A24-Q1	Monopole	1.9 dBi	Fixed/Mobile **	20 cm
*	*	Monopole	1.9 dBi	Fixed/Mobile **	20cm

* FCC-approved antennas not inventoried by Digi – Contact Digi (866) 765-9885 for information.

** Can be approved for portable applications if integrator gains approval through SAR testing

IC (Industry Canada) Certification

Labeling requirements for Industry Canada are similar to those of the FCC. A clearly visible label on the outside of the final product enclosure must display the following text:

Contains Model 9XStream Radio (900 MHz), IC: 4214A-9XSTREAM
Contains Model 24XStream Radio (2.4 GHz), IC: 4214A 12008

Integrator is responsible for its product to comply with IC ICES-003 and FCC Part 15, Sub. B - Unintentional Radiators. ICES-003 is the same as FCC Part 15 Sub. B and Industry Canada accepts FCC test report or CISPR 22 test report for compliance with ICES-003.

Appendix B: Additional Information

1-Year Warranty

XStream RF Modems from Digi International Inc. (the "Product") are warranted against defects in materials and workmanship under normal use, for a period of 1-year from the date of purchase. In the event of a product failure due to materials or workmanship, Digi will repair or replace the defective product. For warranty service, return the defective product to Digi, shipping prepaid, for prompt repair or replacement.

The foregoing sets forth the full extent of Digi's warranties regarding the Product. Repair or replacement at Digi's option is the exclusive remedy. THIS WARRANTY IS GIVEN IN LIEU OF ALL OTHER WARRANTIES, EXPRESS OR IMPLIED, AND DIGI SPECIFICALLY DISCLAIMS ALL WARRANTIES OF MERCHANTABILITY OR FITNESS FOR A PARTICULAR PURPOSE. IN NO EVENT SHALL DIGI, ITS SUPPLIERS OR LICENSORS BE LIABLE FOR DAMAGES IN EXCESS OF THE PURCHASE PRICE OF THE PRODUCT, FOR ANY LOSS OF USE, LOSS OF TIME, INCONVENIENCE, COMMERCIAL LOSS, LOST PROFITS OR SAVINGS, OR OTHER INCIDENTAL, SPECIAL OR CONSEQUENTIAL DAMAGES ARISING OUT OF THE USE OR INABILITY TO USE THE PRODUCT, TO THE FULL EXTENT SUCH MAY BE DISCLAIMED BY LAW. SOME STATES DO NOT ALLOW THE EXCLUSION OR LIMITATION OF INCIDENTAL OR CONSEQUENTIAL DAMAGES. THEREFOR, THE FOREGOING EXCLUSIONS MAY NOT APPLY IN ALL CASES. This warranty provides specific legal rights. Other rights which vary from state to state may also apply.

Ordering Information

Figure B-01. Digi RF Modem Part Numbers Key

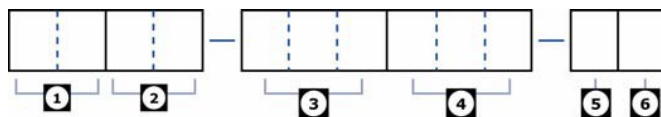

Divisions of the MaxStream PKG RF Modem part numbers:

- | | |
|--|--|
| <p>1 MaxStream Product Family
 XC = XCite
 X = XStream
 XT = XTend</p> | <p>4 Operating Temperature
 PKC = Commercial: 0 to 70° C
 PKI = Industrial: -40 to 85° C. Embedded RF Module is Conformal Coated
 PKT = Tested Industrial: -40 to 85° C. Embedded RF Module is Conformal Coated & 100% tested</p> |
| <p>2 Operating Frequency
 09 = 902-928 MHz
 24 = 2.4000 - 2.4835 GHz (XStream only)
 H9 = 923 MHz (XStream only)</p> | <p>5 Serial Interface (Connector)
 R = RS-232, RS-485/422
 U = USB
 E = Ethernet
 T = Telephone</p> |
| <p>3 Throughput Data Rate
 001 = 1200 bps (XStream only)
 009 = 9600 bps
 019 = 19200 bps (XStream only)
 038 = 38400 bps (XCite Only)
 (blank) All XTend RF Modems support 9600 & 115200 bps (software selectable)</p> | <p>6 Accessories Package
 A = Accessories Package (specific to the Serial Interface) Included
 (blank) means the accessories package is not included</p> |

Contact Digi

If you need assistance, contact technical support:

Documentation: www.digi.com/support/

Technical Support: Phone (866) 765-9885 toll-free U.S. and Canada
 (801) 765-9885 Worldwide
 8:00 am – 5:00 pm (U.S. Central Time)

 Online www.digi.com/support/eservice

Mouser Electronics

Authorized Distributor

Click to View Pricing, Inventory, Delivery & Lifecycle Information:

[Digi International:](#)

[A09-HBMM-P5I](#)