

Antenna Datasheet

Product OC (Antenna Only): YC0002BA

(Antenna + Rectangular EVB): YC0002BAEVB

Version: 2.1

Date: 2023-11-21

Status: Released

Product Name: 4G SMD Antenna

Key Features:

High efficiency, excellent performance

Frequency band: 700–960 MHz, 1710–2690 MHz

Peak efficiency: 75.3 % (On 116 mm × 60 mm GND)

Dimensions: 42 mm × 10 mm × 3 mm

Overview

This Quectel embedded 4G SMD antenna covers main 4G LTE bands and is compatible with 3G/2G/LPWA bands. Featuring high efficiency and gain, it is an ideal antenna for a smooth and stable connection with high-efficiency data transmission even under the influence of the device's internal structure. Ground plane dependent, it's designed to be mounted directly to the device host PCB using a conventional PCB reflow process. Supplied tape and reel for high volume pick and place assembly, this SMD antenna can be tuned specifically for the final device environment with a simple PI matching circuit.

Contents

Overview	1
Contents	2
1 Specification	3
1.1. Electrical.....	3
1.2. Supported Bands	5
1.3. Mechanical & Environmental	7
2 Drawing	8
2.1. Antenna.....	8
2.2. EVB	9
3 Detailed Performance	10
3.1. Overview	10
3.2. S-Parameter Test	11
3.2.1. VSWR	11
3.2.2. Return Loss	12
3.3. Radiation Performance Test.....	13
3.3.1. Efficiency.....	13
3.3.2. Average Gain	14
3.3.3. Peak Gain	15
3.3.4. 3D & 2D Radiation Pattern	16
4 Schematic Symbol and Pin Definition	20
5 Transmission Line	21
6 Recommended PCB Layout	22
7 Matching Circuit	23
8 Soldering Temperature	24
9 Reflow Profile	25
10 Packaging	26
Contact Us	28
Legal Notices	29
Revision History	31

1 Specification

Test Condition: Assembled On EVB

1.1. Electrical

Electrical	
Frequency Range	700–960 MHz, 1710–2690 MHz
Impedance	50 Ω
Polarization	Linear
Radiation Pattern	Omni-directional

Electrical - Detail									
SPEC	Band	Band	B71	B12 /B13 /B28	B5 /B8 /B26	B1 /B2 /B3	B40	Wi-Fi 2G	B38 /B41
		Freq. (MHz)	600– 700	700– 810	820– 960	1700– 2170	2300– 2400	2400– 2500	2500– 2690
Max VSWR		On 116 × 60 mm GND	-	4.8	3.5	3.7	2.1	2.1	1.9
		On 106 × 60 mm GND	-	5.2	3.6	4.0	2.0	2.0	1.9
		On 96 × 60 mm GND	-	5.8	4.4	4.0	1.9	1.9	1.9
		On 86 × 60 mm GND	-	6.6	4.9	3.7	1.9	1.9	1.8
		On 76 × 60 mm GND	-	7.0	5.7	3.2	1.9	1.9	1.8
Max Return Loss (dB)		On 116 × 60 mm GND	-	-3.7	-5.1	-4.8	-9.0	-9.0	-9.9
		On 106 × 60 mm GND	-	-3.4	-5.0	-4.4	-9.6	-9.6	-9.9
		On 96 × 60 mm GND	-	-3.0	-4.0	-4.4	-10.3	-10.1	-10.3
		On 86 × 60 mm GND	-	-2.7	-3.6	-4.9	-10.4	-10.4	-11.2

	On 76 × 60 mm GND	-	-2.5	-3.1	-5.5	-9.9	-9.9	-10.9	
AVG Eff. (%)	On 116 × 60 mm GND	-	42.9	48.8	51.3	72.5	71.9	72.5	
	On 106 × 60 mm GND	-	39.6	44.9	48.6	71.1	71.8	73.3	
	On 96 × 60 mm GND	-	35.9	45.7	47.5	71.7	72.8	74.3	
	On 86 × 60 mm GND	-	30.2	39.5	44.3	69.2	72.3	76.4	
	On 76 × 60 mm GND	-	24.5	34.8	47.8	69.7	70.7	75.5	
		On 76 × 60 mm GND	-	24.5	34.8	47.8	69.7	70.7	75.5
AVG AVG Gain (dB)	On 116 × 60 mm GND	-	-3.7	-3.1	-2.9	-1.4	-1.4	-1.4	
	On 106 × 60 mm GND	-	-4.1	-3.5	-3.1	-1.5	-1.4	-1.4	
	On 96 × 60 mm GND	-	-4.5	-3.4	-3.3	-1.4	-1.4	-1.3	
	On 86 × 60 mm GND	-	-5.3	-4.0	-3.5	-1.6	-1.4	-1.2	
	On 76 × 60 mm GND	-	-6.2	-4.6	-3.2	-1.6	-1.5	-1.2	
Max Peak Gain (dBi)	On 116 × 60 mm GND	-	-0.2	0.0	2.7	2.8	4.0	4.1	
	On 106 × 60 mm GND	-	-0.1	0.4	2.4	2.9	3.5	4.4	
	On 96 × 60 mm GND	-	-0.4	0.2	2.0	2.8	3.2	3.7	
	On 86 × 60 mm GND	-	-1.2	-0.6	0.8	2.7	3.3	3.5	
	On 76 × 60 mm GND	-	-2.2	-1.4	1.1	2.7	3.4	3.5	
VSWR	On 116 × 60 mm GND					≤ 4.8			
	On 106 × 60 mm GND					≤ 5.2			
	On 96 × 60 mm GND					≤ 5.8			
	On 86 × 60 mm GND					≤ 6.6			
	On 76 × 60 mm GND					≤ 7.0			
Return Loss	On 116 × 60 mm GND					≤ -3.7 dB			
	On 106 × 60 mm GND					≤ -3.4 dB			
	On 96 × 60 mm GND					≤ -3.0 dB			
	On 86 × 60 mm GND					≤ -2.7 dB			
	On 76 × 60 mm GND					≤ -2.5 dB			

Peak Gain	On 116 × 60 mm GND	≤ 4.1 dBi
	On 106 × 60 mm GND	≤ 4.4 dBi
	On 96 × 60 mm GND	≤ 3.7 dBi
	On 86 × 60 mm GND	≤ 3.5 dBi
	On 76 × 60 mm GND	≤ 3.5 dBi

1.2. Supported Bands

5G NR / LTE / LTE-Advanced / WCDMA / HSPA / HSPA+ / GPRS / GSM / NB-IoT				
Band	Frequency (MHz)	Uplink (MHz)	Downlink (MHz)	Covered
1	2100	1920–1980	2110–2170	√
2	1900	1850–1910	1930–1990	√
3	1800	1710–1785	1805–1880	√
4	1700	1710–1755	2110–2155	√
5	850	824–849	869–894	√
7	2600	2500–2570	2620–2690	√
8	900	880–915	925–960	√
9	1800	1749.9-1784.9	1844.9-1879.9	√
11	1500	1427.9–1447.9	1475.9–1495.9	-
12	700	699–716	729–746	√
13	700	777–787	746–756	√
14	700	788–798	758–768	√
17	700	704–716	734–746	√
18	850	815–830	860–875	√
19	850	830–845	875–890	√
20	800	832–862	791–821	√

21	1500	1447.9–1462.9	1495.9–1510.9	-
22	3500	3410–3490	3510–3590	-
23	2100	2000–2020	2180–2200	√
24	1600	1626.5–1660.5	1525–1559	-
25	1900	1850–1915	1930–1995	√
26	850	814–849	859–894	√
28	700	703–748	758–803	√
31	450	452.5–457.5	462.5–467.5	-
34	2100	2010–2025		√
38	2600	2570–2620		√
39	1900	1880–1920		√
40	2300	2300–2400		√
41	2500	2496–2690		√
42	3500	3400–3600		-
48	3500	3550–3700		-
66	1700	1710–1780	2110–2200	√
71	600	663–698	617–652	-
74	1500	1427–1470	1475–1518	-
77	3500	3300–4200		-
78	3500	3300–3800		-
79	4500	4400–5000		-

Note:

- Covered √ means efficiency > 20%.
- Based on 116 mm × 60 mm GND.

1.3. Mechanical & Environmental

Mechanical	
Antenna Size	42 mm × 10 mm × 3 mm
Antenna Material & Color	FR4 & Black
Antenna Weight	Typ. 1 g
Mounting Type	SMD
Recommended EVB Size	131 mm × 60 mm
Environmental	
Operation Temperature	-40 °C to +85 °C
Storage Temperature	-40 °C to +85 °C
RoHS & REACH Compliant	Yes

2 Drawing

2.1. Antenna

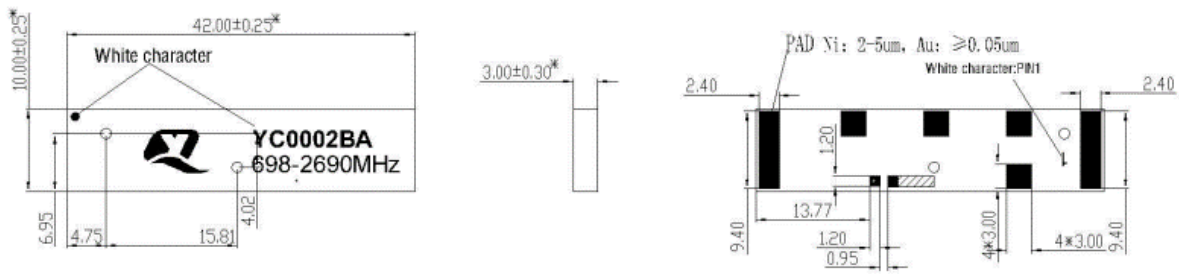

All dimensions in (mm)

2.2. EVB

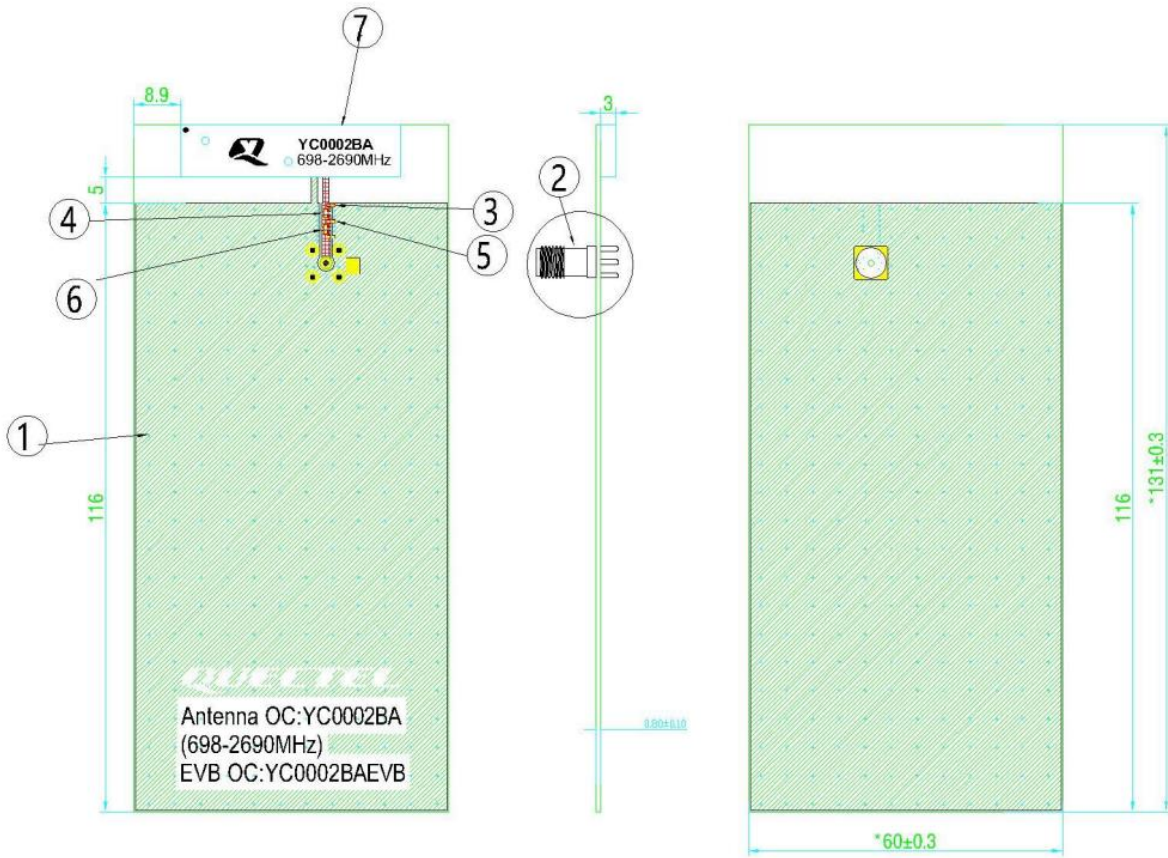

All dimensions in (mm)

3 Detailed Performance

3.1. Overview

The performance of the low bands is highly dependent on the ground plane length. The host PCB ground needs to be as long as the device allows. Reducing the GND directly relates to the performance of the low bands. As shown below you can see the effect of the GND plane length vs the efficiency.

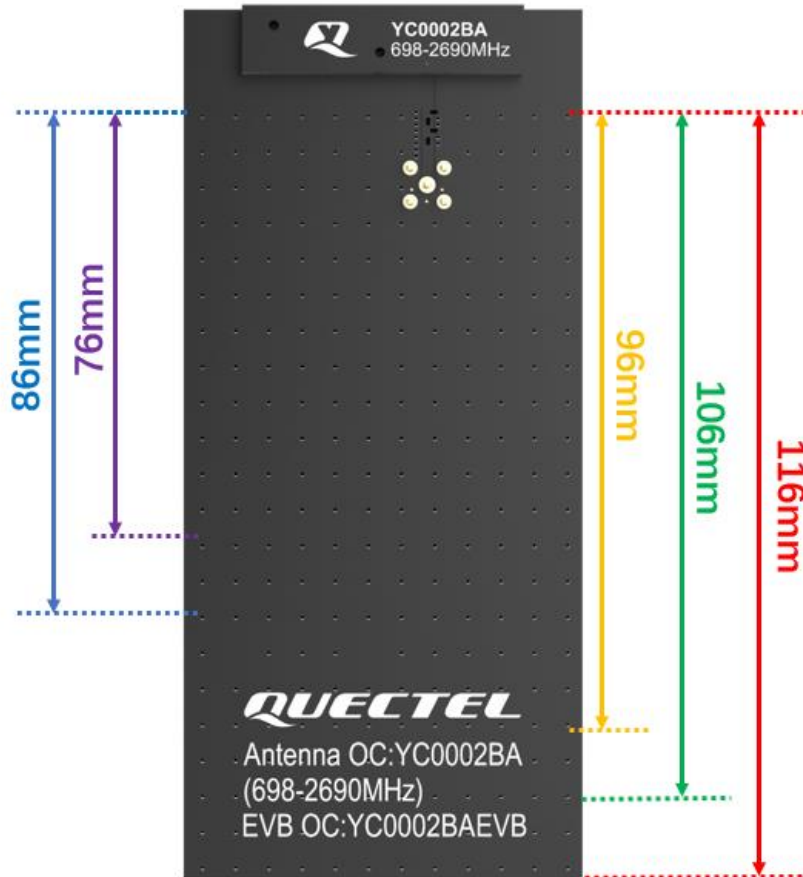

3.2. S-Parameter Test

3.2.1. VSWR

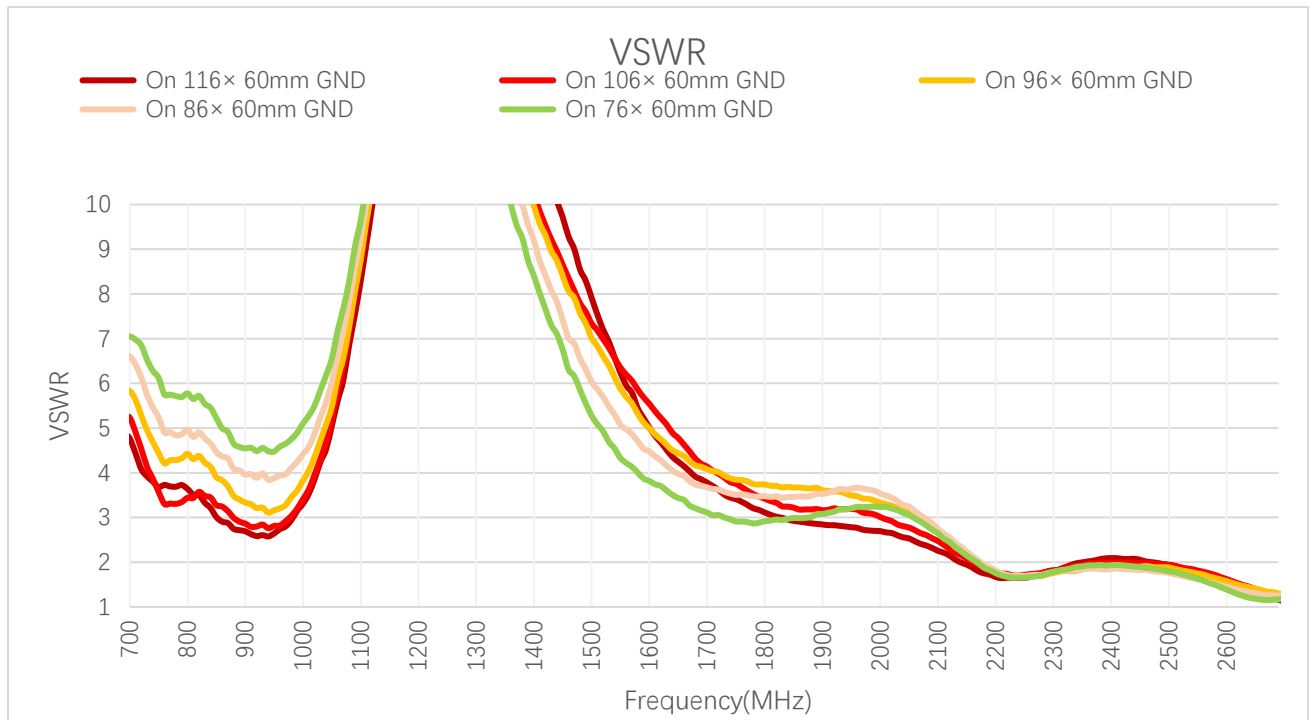

Frequency (MHz)	710	830	900	1740	1880	1950	2140	2450	2600	2690
On 116 × 60 mm GND	4.4	3.3	2.7	3.4	2.9	2.8	2.0	2.1	1.6	1.2
On 106 × 60 mm GND	4.9	3.5	2.9	3.8	3.2	3.2	2.2	2.0	1.6	1.2
On 96 × 60 mm GND	5.6	4.2	3.3	3.9	3.7	3.5	2.3	1.9	1.6	1.3
On 86 × 60 mm GND	6.4	4.8	4.0	3.5	3.5	3.6	2.3	1.8	1.5	1.3
On 76 × 60 mm GND	7.0	5.5	4.5	3.0	3.0	3.2	2.2	1.9	1.4	1.2

3.2.2. Return Loss

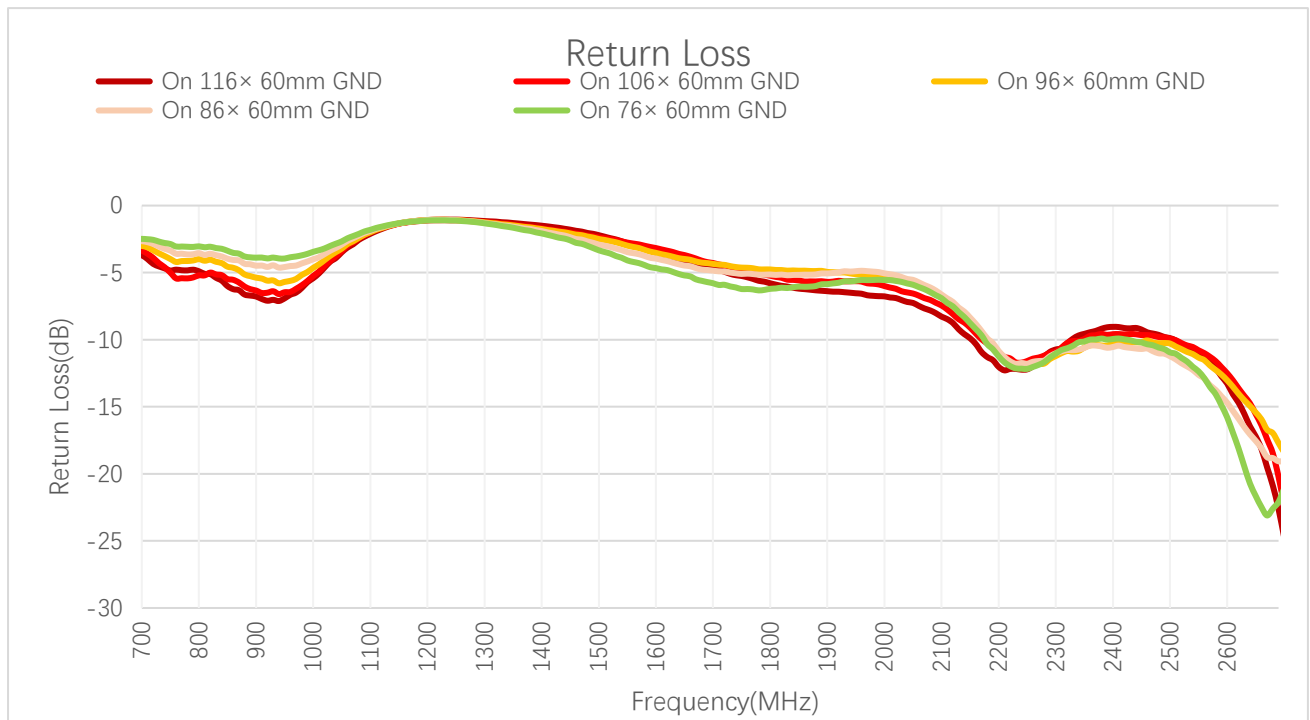

Return Loss (dB)

Frequency (MHz)	710	830	900	1740	1880	1950	2140	2450	2600	2690
On 116 × 60mm GND	-4.0	-5.4	-6.8	-5.2	-6.3	-6.5	-9.6	-9.2	-13.3	-22.6
On 106 × 60 mm GND	-3.6	-5.1	-6.3	-4.7	-5.7	-5.6	-8.7	-9.7	-12.5	-20.2
On 96 × 60 mm GND	-3.1	-4.2	-5.4	-4.6	-4.9	-5.1	-8.2	-10.2	-13.0	-17.7
On 86 × 60 mm GND	-2.7	-3.7	-4.5	-5.0	-5.1	-4.9	-7.9	-10.7	-14.7	-19.1
On 76 × 60 mm GND	-2.5	-3.2	-3.9	-6.1	-6.0	-5.6	-8.3	-10.2	-15.8	-22.1

3.3. Radiation Performance Test

3.3.1. Efficiency

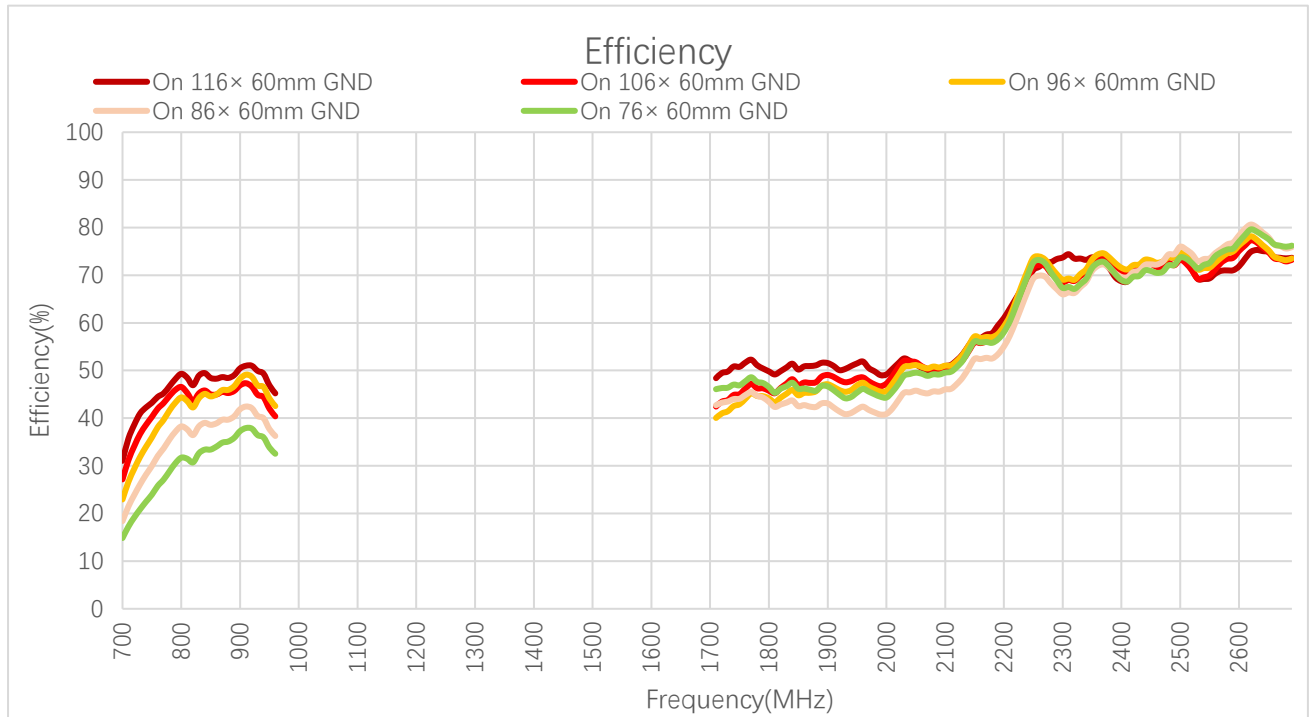

Efficiency (%)

Frequency (MHz)	710	830	900	1740	1880	1950	2140	2450	2600	2690
On 116 × 60 mm GND	35.7	48.9	50.5	50.8	51.1	51.5	55.2	72.8	71.9	73.7
On 106 × 60 mm GND	31.2	45.2	46.9	44.9	47.5	48.4	54.1	72.4	75.1	73.2
On 96 × 60 mm GND	26.6	44.2	48.3	42.5	45.6	46.9	55.3	73.1	76.2	73.5
On 86 × 60 mm GND	21.5	38.3	41.9	44.0	42.4	41.8	50.5	72.3	78.3	75.9
On 76 × 60 mm GND	17.2	32.6	37.3	47.0	45.8	45.4	54.2	70.9	77.0	76.2

3.3.2. Average Gain

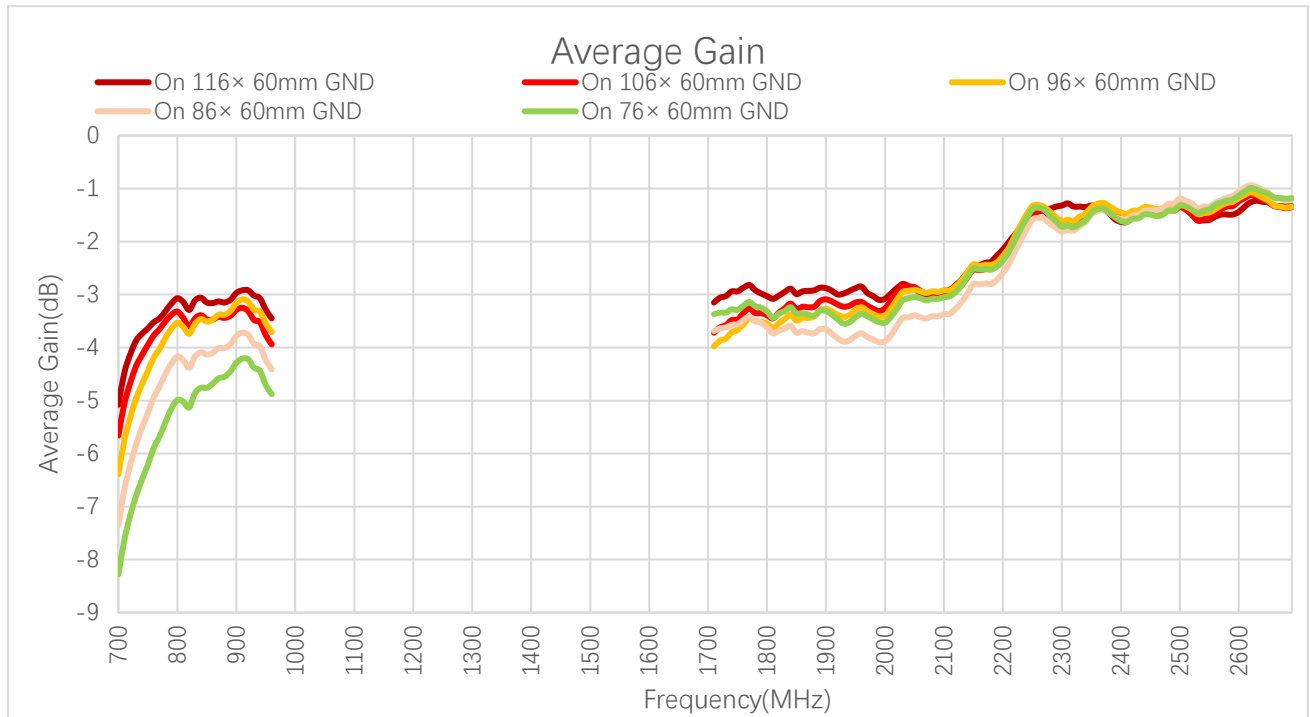

Average Gain (dB)

Frequency (MHz)	710	830	900	1740	1880	1950	2140	2450	2600	2690
On 116 × 60 mm GND	-4.5	-3.1	-3.0	-2.9	-2.9	-2.9	-2.6	-1.4	-1.4	-1.3
On 106 × 60 mm GND	-5.1	-3.5	-3.3	-3.5	-3.2	-3.2	-2.7	-1.4	-1.2	-1.4
On 96 × 60 mm GND	-5.8	-3.6	-3.2	-3.7	-3.4	-3.3	-2.6	-1.4	-1.2	-1.3
On 86 × 60 mm GND	-6.7	-4.2	-3.8	-3.6	-3.7	-3.8	-3.0	-1.4	-1.1	-1.2
On 76 × 60 mm GND	-7.6	-4.9	-4.3	-3.3	-3.4	-3.4	-2.7	-1.5	-1.1	-1.2

3.3.3. Peak Gain

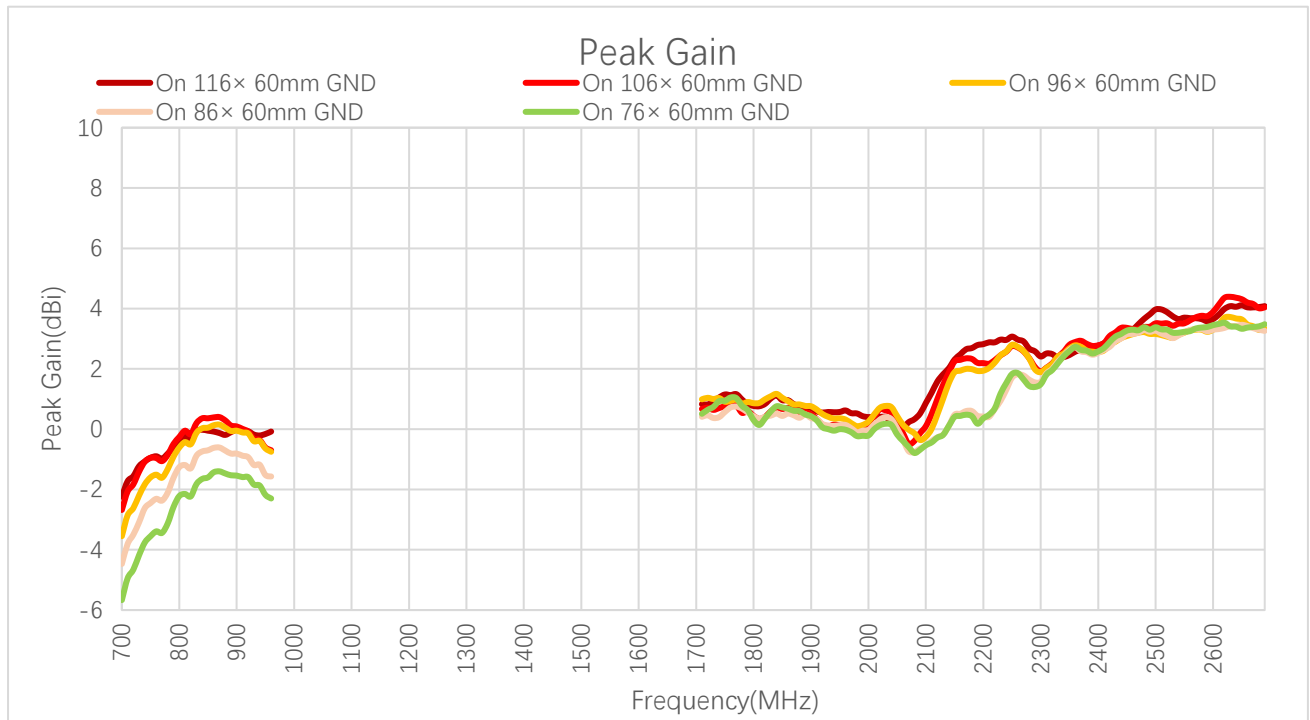

Peak Gain (dBi)

Frequency (MHz)	710	830	900	1740	1880	1950	2140	2450	2600	2690
On 116 × 60 mm GND	-1.7	-0.1	0.0	1.1	0.8	0.6	2.0	3.2	3.7	4.1
On 106 × 60 mm GND	-2.1	0.2	0.1	0.7	0.5	0.1	1.9	3.4	3.9	4.0
On 96 × 60 mm GND	-2.9	-0.1	-0.1	1.0	0.8	0.4	1.5	3.1	3.3	3.3
On 86 × 60 mm GND	-3.8	-0.9	-0.8	0.4	0.4	0.1	0.1	3.2	3.3	3.3
On 76 × 60 mm GND	-5.0	-1.8	-1.5	0.9	0.6	0.0	0.1	3.3	3.5	3.5

3.3.4. 3D & 2D Radiation Pattern

- Test Status: Assembled on 116 mm × 60 mm GND

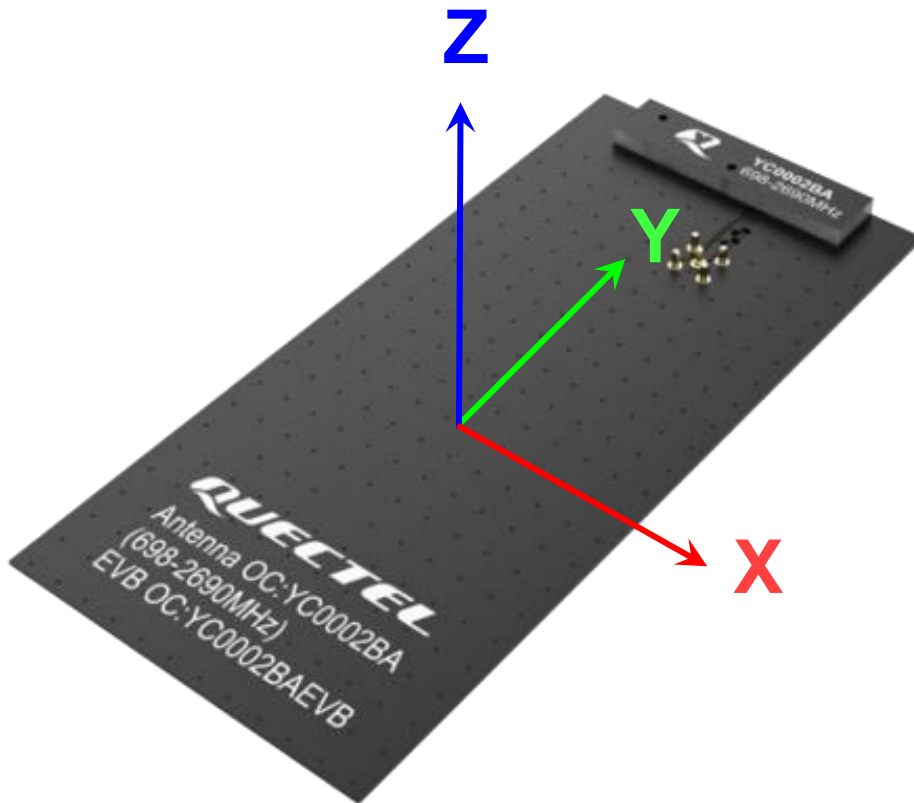

● 4G

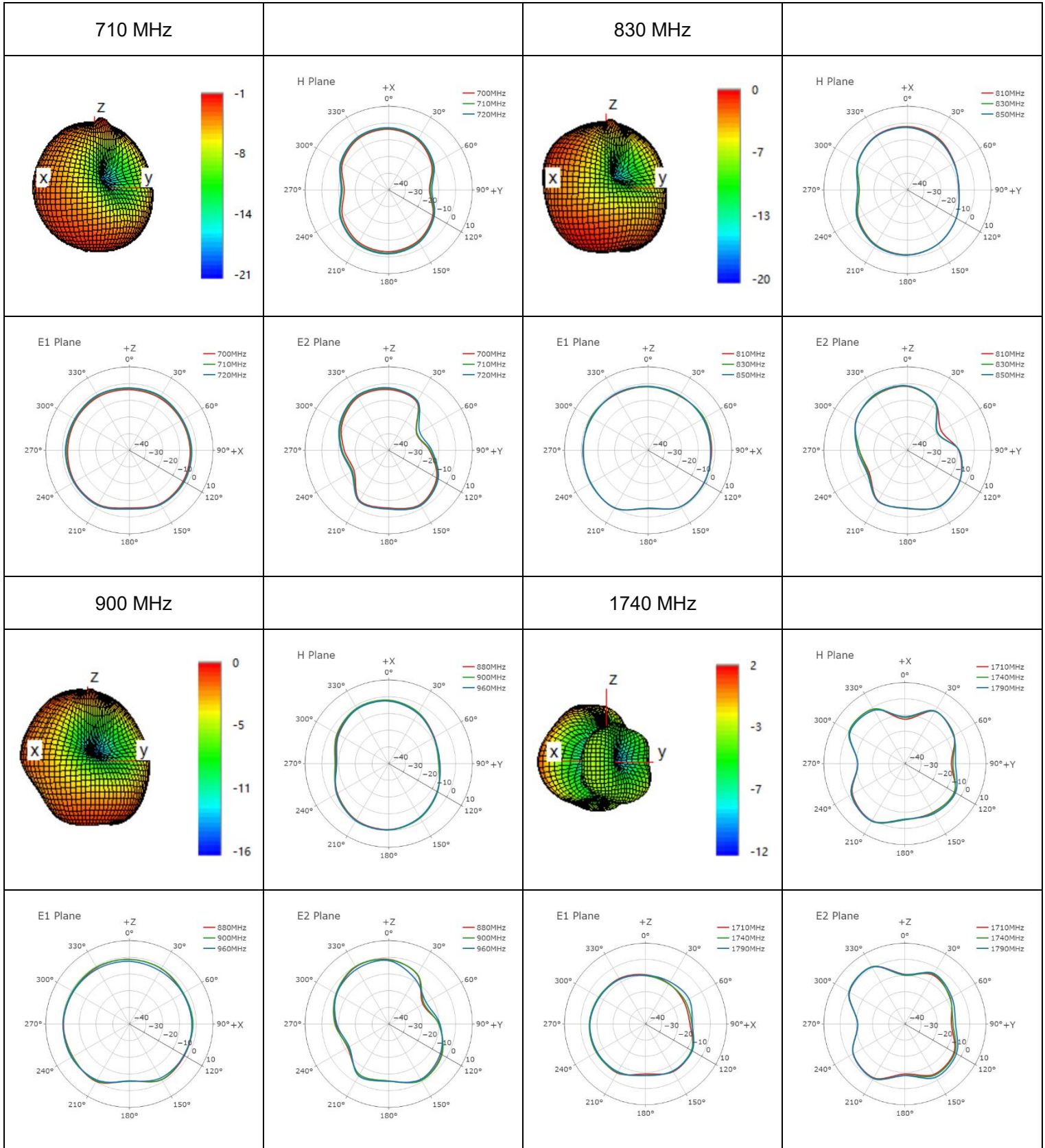

● 4G

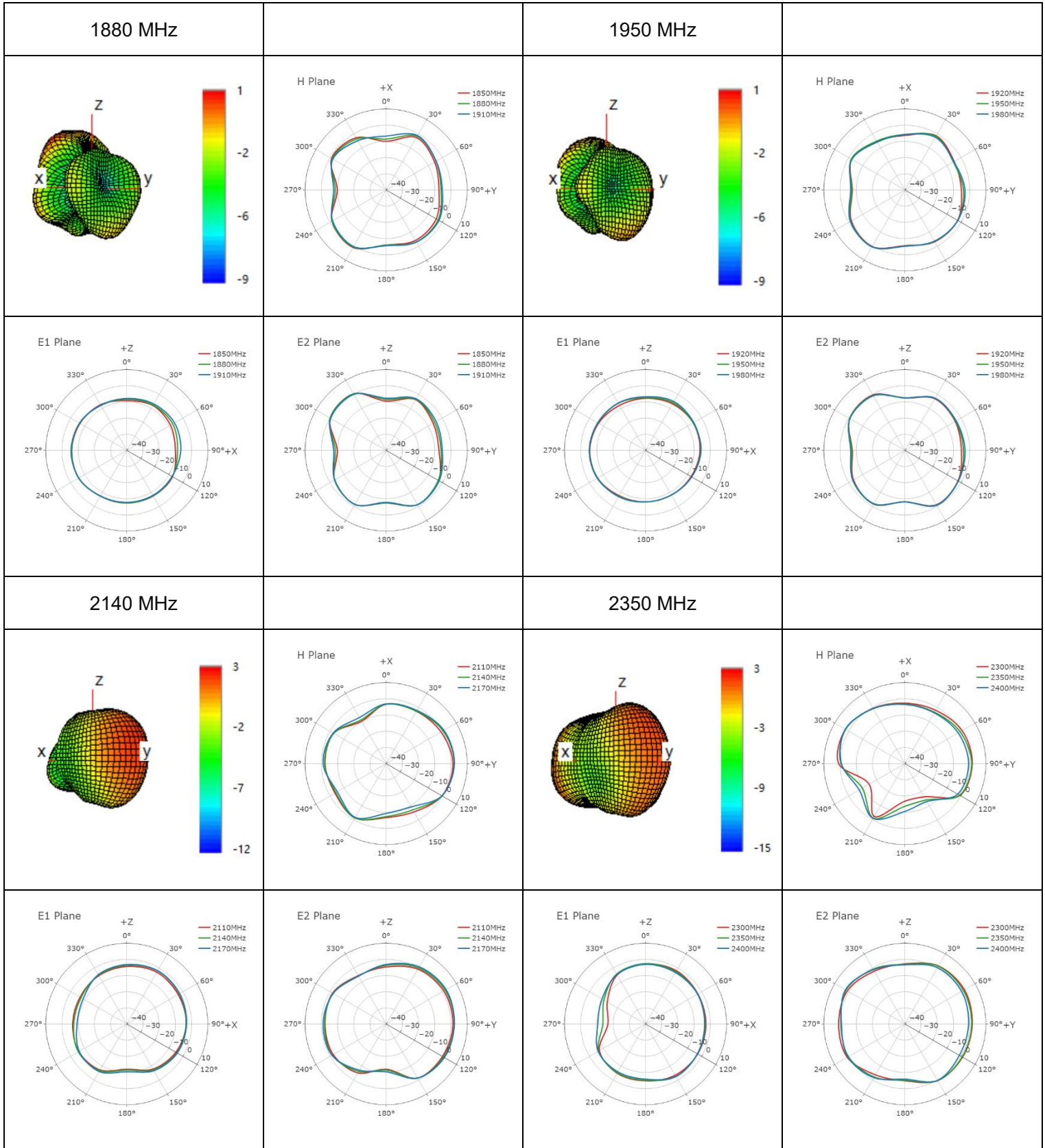

● 4G

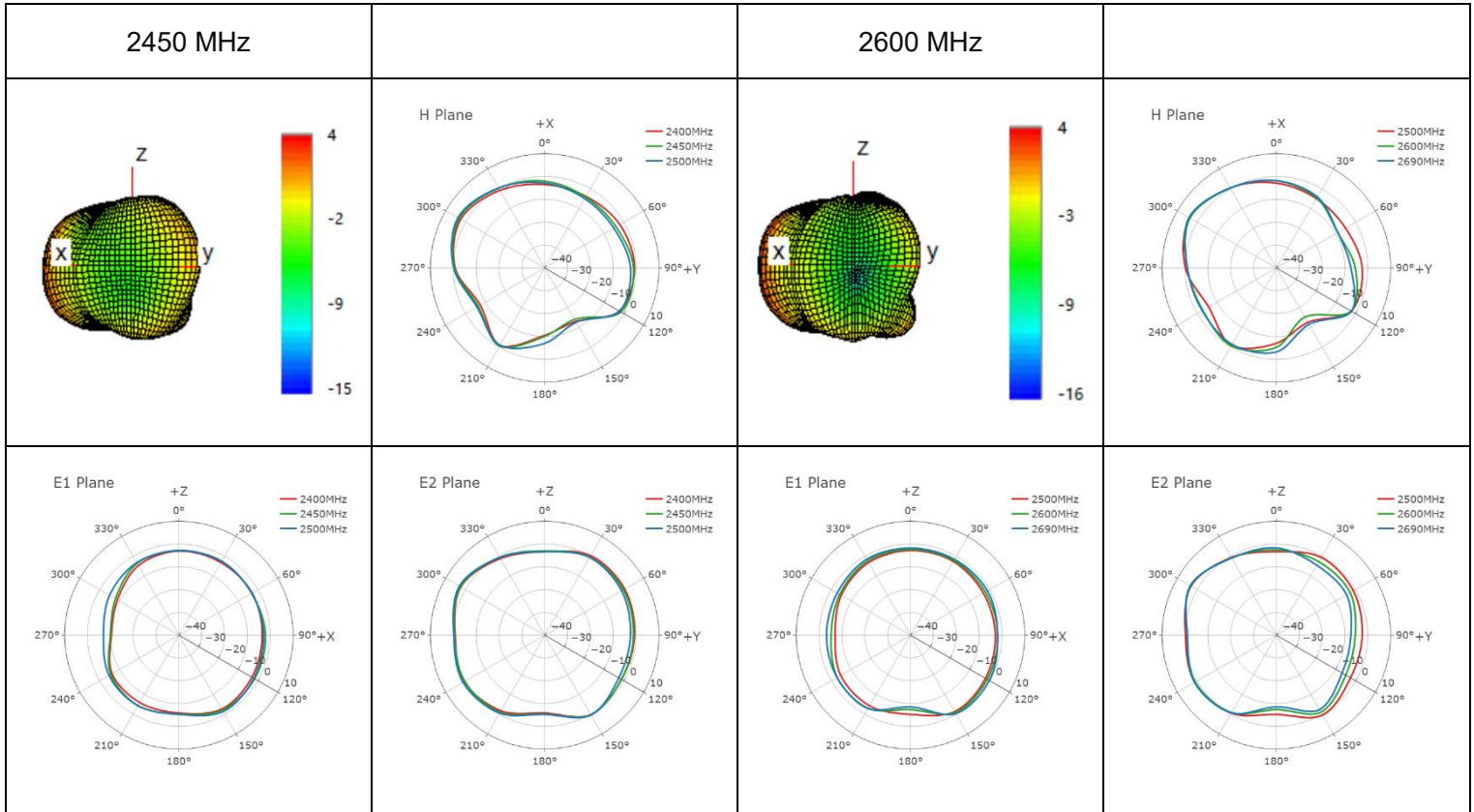

4 Schematic Symbol and Pin Definition

- The pin assignment for the antenna is as follows.
- The circuit symbol for the antenna is shown below. The antenna has 8 pins, only two of which work. All other pins are for mechanical strength.

Pin	Description
6	Feed
1, 2 3,4, 5, 8	Not used (Mechanical only)
7	GND

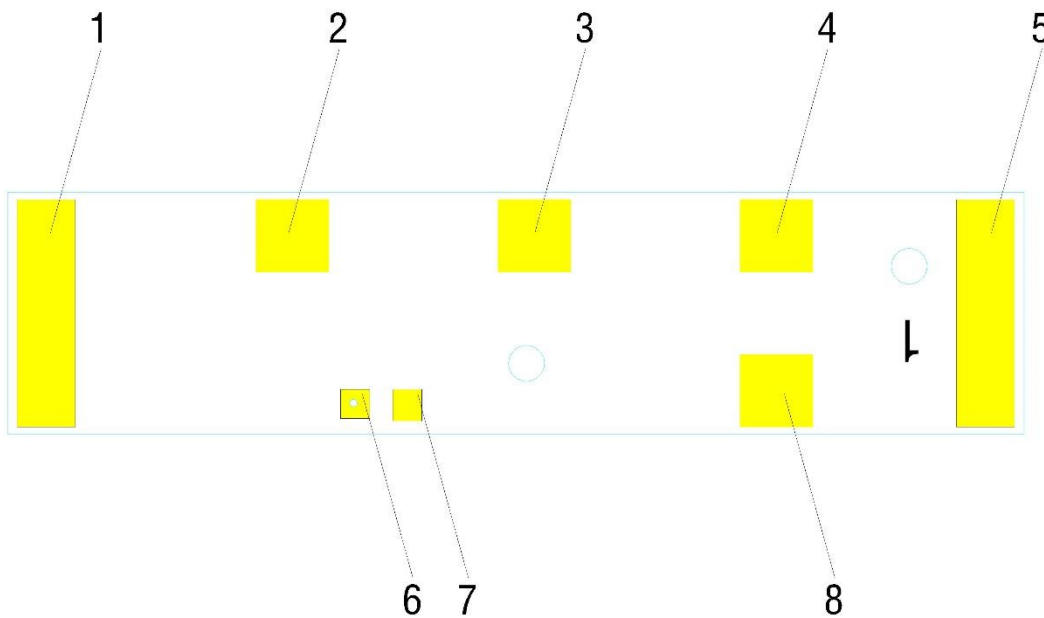

5 Transmission Line

The characteristic impedance of all transmission lines shall be designed as 50 Ω .

- The length of the transmission lines should be kept as short as possible.
- Any other part of the RF system, such as transceiver, power amplifiers, etc., shall also be designed with an impedance of 50 Ω .

Once the material for the PCB has been chosen (PCB thickness and dielectric constant), a coplanar transmission line can easily be designed using any of the commercial software packages for transmission line design. For the chosen PCB thickness, copper thickness and substrate dielectric constant, the program will calculate the appropriate transmission line width and gaps on either side of the track so the characteristic impedance of the coplanar transmission is 50 Ω .

6 Recommended PCB Layout

The host PCB must be designed using the PCB footprint shown with the correct clearances. An example of the PCB layout shows the antenna footprint. Please note this clearance area is critical to the performance of the antenna and must be applied through all layers of the PCB.

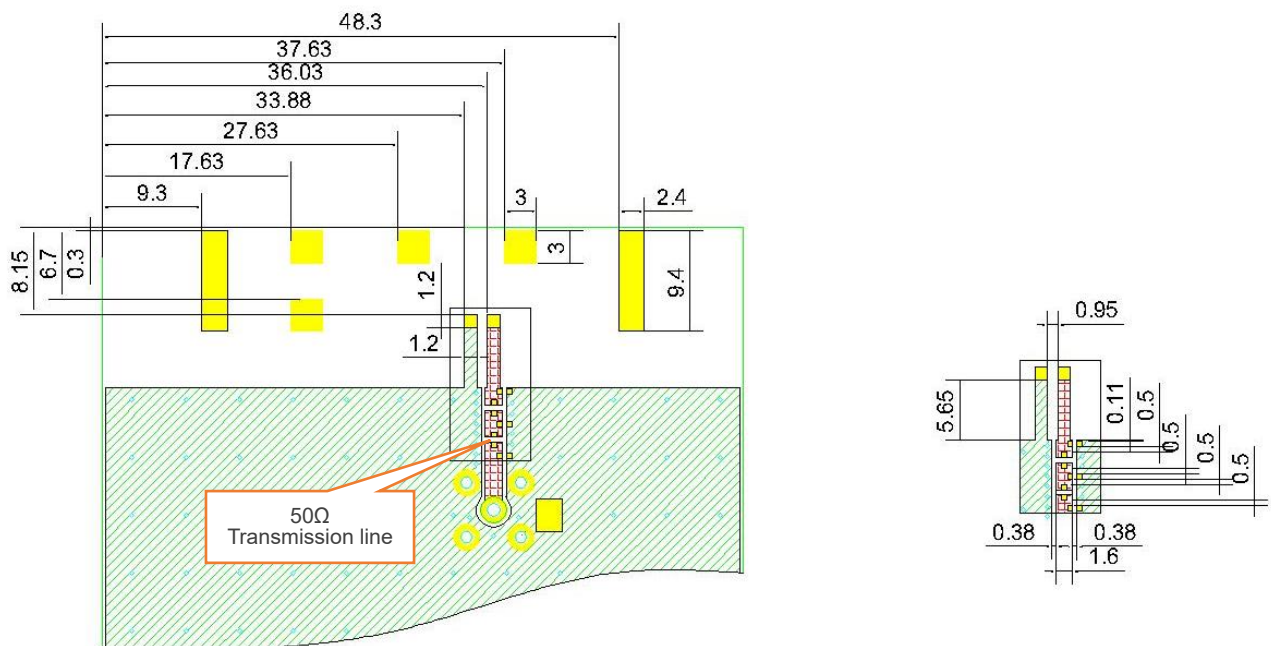

All dimensions in (mm)

7 Matching Circuit

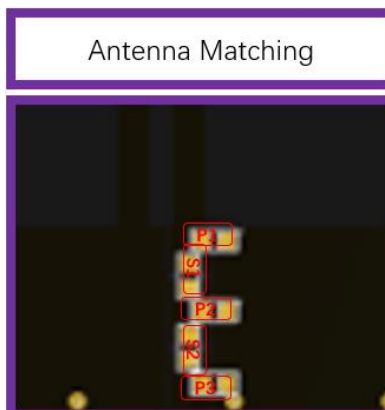
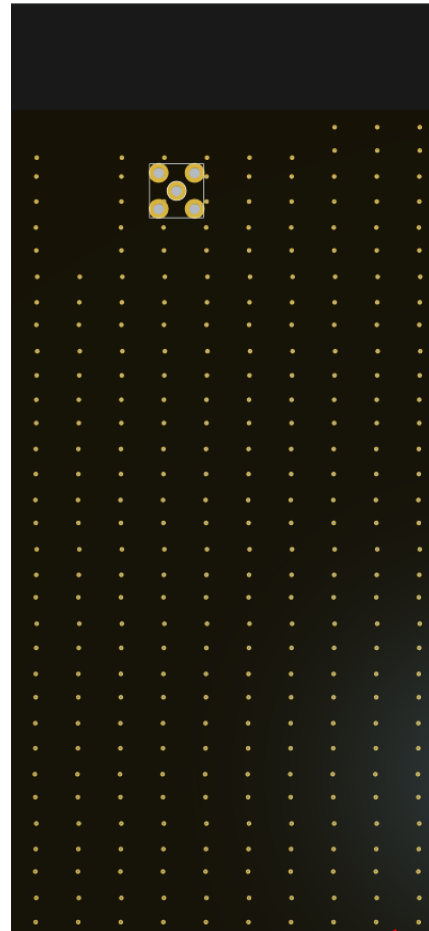
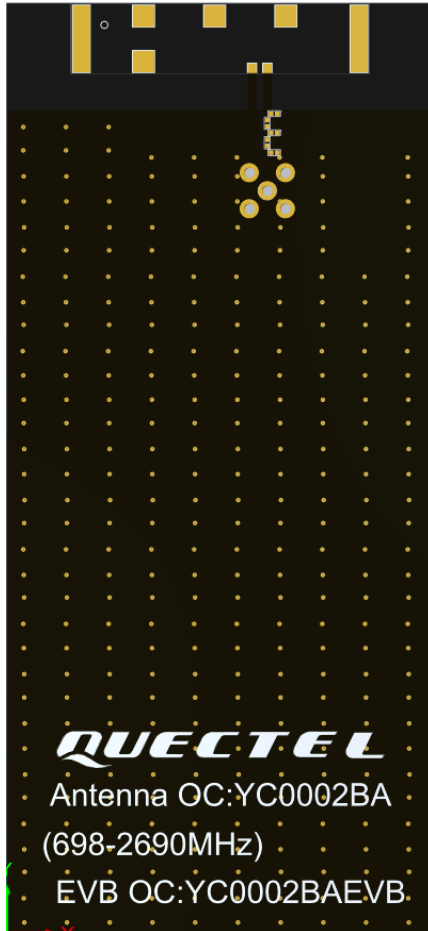

	P1	S1	P2	S2	P3
Default Matching	9.1 nH	8.2 pF	0.75 pF	2.7 nH	NC
Tolerance	±5 %	±5 %	±5 %	±5 %	N/A

8 Soldering Temperature

Phase	Profile Features	PB-Free Assembly
RAMP-UP	Avg. Ramp-up Rate (T _{max} to T _p)	3 °C/second (Max.)
PREHEAT	Temperature Min (T _{min}) Temperature Max (T _{max}) Time (t _{min} to t _{max})	150 °C 190 °C 110 seconds (Max.)
REFLOW	Temperature (TL) Total Time above TL (tl)	220 °C 90 seconds (Max.)
PEAK	Temperature (T _p)	230–250 °C
RAMP-DOWN	Rate	-1 °C/second (Max.)

9 Reflow Profile

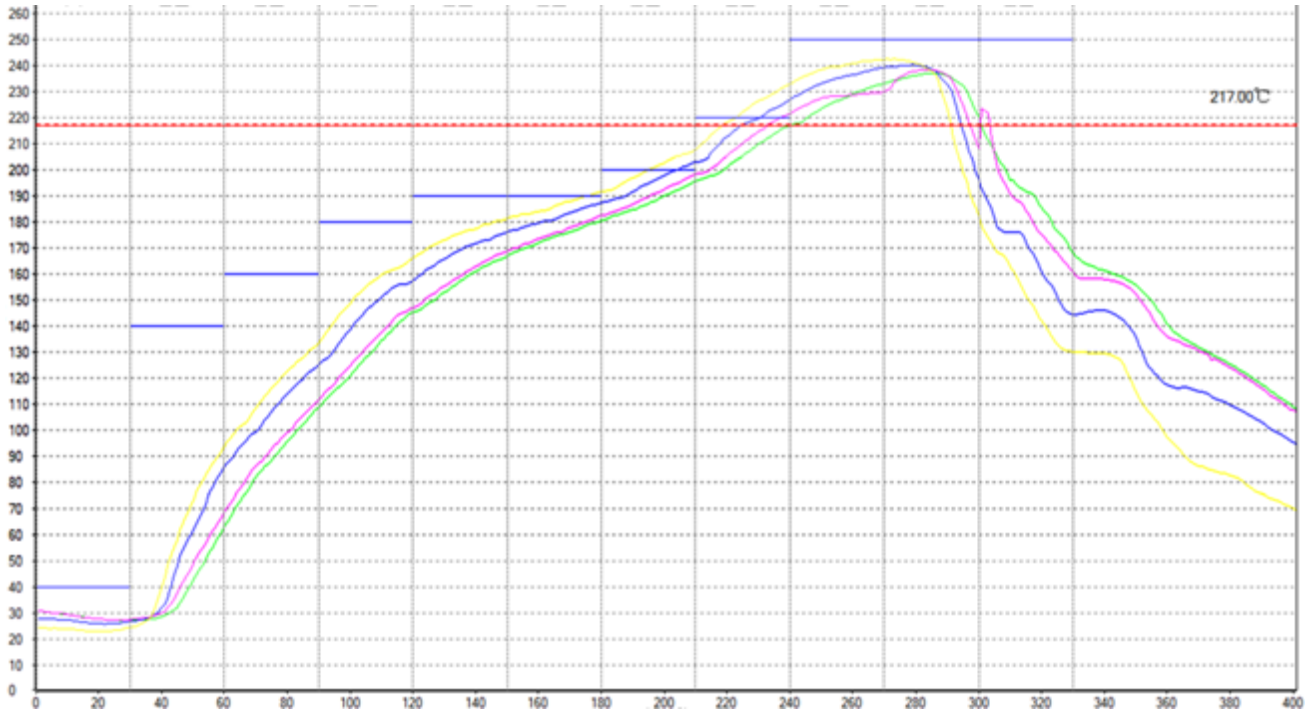

10 Packaging

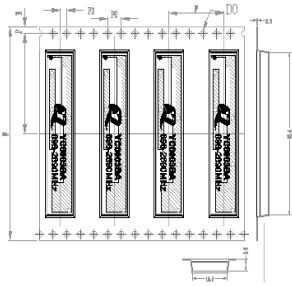
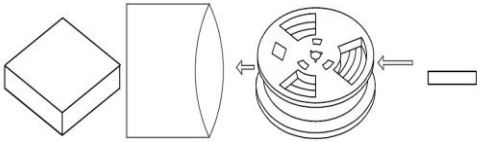
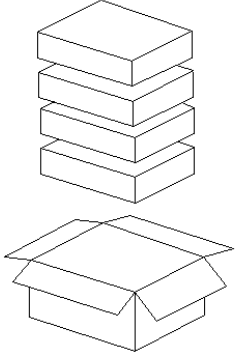
Step	Packaging Picture / 2D Picture	Description
1		Reel
2		<p>(1200 PCS Antennas / Reel) Reel tape is vacuumed into the inner box.</p>
3		<p>(4 Inner Boxes / Carton Box) (4800 pcs Antennas / Carton Box) Estimated quantity Products that cannot fill the entire carton box are packed in a suitable size carton box. <u>Carton Size:</u> <u>L × W × H = 370 × 370 × 295 mm</u></p>

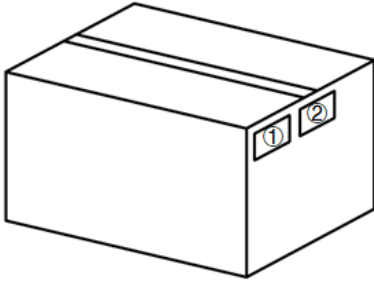
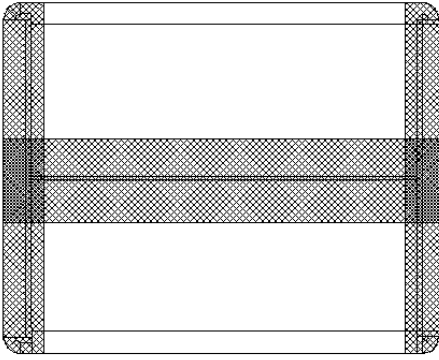
<p>4</p>		<p>Position for Attaching Labels</p> <p>① Carton Label ② Quality Label</p>
<p>5</p>		<p>Sealing Cartons</p> <p>“I” type sealing cartons</p>
<p>6</p>	<p>The initial packaging method described above is for reference only, and the final actual packaging method shall be subject to the actual shipping packaging.</p>	

Contact Us

At Quectel, our aim is to provide timely and comprehensive services to our customers. If you require any assistance, please contact our headquarters:

Quectel Wireless Solutions Co., Ltd.

Building 5, Shanghai Business Park Phase III (Area B), No.1016 Tianlin Road, Minhang District, Shanghai 200233, China

Tel: +86 21 5108 6236

Email: info@quectel.com

Or our local offices. For more information, please visit:

<http://www.quectel.com/support/sales.htm>.

For technical support, or to report documentation errors, please visit:

<http://www.quectel.com/support/technical.htm>.

Or email us at: support@quectel.com.

Legal Notices

We offer information as a service to you. The provided information is based on your requirements and we make every effort to ensure its quality. You agree that you are responsible for using independent analysis and evaluation in designing intended products, and we provide reference designs for illustrative purposes only. Before using any hardware, software or service guided by this document, please read this notice carefully. Even though we employ commercially reasonable efforts to provide the best possible experience, you hereby acknowledge and agree that this document and related services hereunder are provided to you on an “as available” basis. We may revise or restate this document from time to time at our sole discretion without any prior notice to you.

Use and Disclosure Restrictions

License Agreements

Documents and information provided by us shall be kept confidential, unless specific permission is granted. They shall not be accessed or used for any purpose except as expressly provided herein.

Copyright

Our and third-party products hereunder may contain copyrighted material. Such copyrighted material shall not be copied, reproduced, distributed, merged, published, translated, or modified without prior written consent. We and the third party have exclusive rights over copyrighted material. No license shall be granted or conveyed under any patents, copyrights, trademarks, or service mark rights. To avoid ambiguities, purchasing in any form cannot be deemed as granting a license other than the normal non-exclusive, royalty-free license to use the material. We reserve the right to take legal action for noncompliance with abovementioned requirements, unauthorized use, or other illegal or malicious use of the material.

Trademarks

Except as otherwise set forth herein, nothing in this document shall be construed as conferring any rights to use any trademark, trade name or name, abbreviation, or counterfeit product thereof owned by Quectel or any third party in advertising, publicity, or other aspects.

Third-Party Rights

This document may refer to hardware, software and/or documentation owned by one or more third parties (“third-party materials”). Use of such third-party materials shall be governed by all restrictions and obligations applicable thereto.

We make no warranty or representation, either express or implied, regarding the third-party materials, including but not limited to any implied or statutory, warranties of merchantability or fitness for a particular purpose, quiet enjoyment, system integration, information accuracy, and non-infringement of any third-party intellectual property rights with regard to the licensed technology or use thereof. Nothing herein constitutes a representation or warranty by us to either develop, enhance, modify, distribute, market, sell, offer for sale, or otherwise maintain production of any our products or any other hardware, software, device, tool, information, or product. We moreover disclaim any and all warranties arising from the course of dealing or usage of trade.

Privacy Policy

To implement module functionality, certain device data are uploaded to Quectel's or third-party's servers, including carriers, chipset suppliers or customer-designated servers. Quectel, strictly abiding by the relevant laws and regulations, shall retain, use, disclose or otherwise process relevant data for the purpose of performing the service only or as permitted by applicable laws. Before data interaction with third parties, please be informed of their privacy and data security policy.

Disclaimer

- a) We acknowledge no liability for any injury or damage arising from the reliance upon the information.
- b) We shall bear no liability resulting from any inaccuracies or omissions, or from the use of the information contained herein.
- c) While we have made every effort to ensure that the functions and features under development are free from errors, it is possible that they could contain errors, inaccuracies, and omissions. Unless otherwise provided by valid agreement, we make no warranties of any kind, either implied or express, and exclude all liability for any loss or damage suffered in connection with the use of features and functions under development, to the maximum extent permitted by law, regardless of whether such loss or damage may have been foreseeable.
- d) We are not responsible for the accessibility, safety, accuracy, availability, legality, or completeness of information, advertising, commercial offers, products, services, and materials on third-party websites and third-party resources.

Copyright © Quectel Wireless Solutions Co., Ltd. 2023. All rights reserved.

Revision History

Version	Date	Author	Note
-	2022-09-22	Kane LIU/ Joye WANG	Creation of the document
1.0	2022-09-22	Kane LIU/ Joye WANG	First official release
1.1	2023-04-20	Joye WANG	Added drawings in Chapters 5 and 6.
2.0	2023-09-27	Kane LIU/ Joye WANG/ David LIU/ Vinnie LIU	Updated the templates.
2.1	2023-11-21	Kane LIU/ Joye WANG/ David LIU/ Vinnie LIU	Updated matching circuit (Chapters 7).

QUECTEL

www.quectel.com

Mouser Electronics

Authorized Distributor

Click to View Pricing, Inventory, Delivery & Lifecycle Information:

[Quectel:](#)

[YC0002BA](#)