

Flat Gain, High Dynamic Range

Monolithic Amplifier

PGA-106R-75+

75Ω 5 to 250 MHz

The Big Deal

- High IP3 and IP2
- Flat Gain / Excellent Return Loss
- Low Noise Figure



SOT-89 PACKAGE

Product Overview

PGA-106R-75+ (RoHS compliant) is an advanced 75 ohm amplifier fabricated using E-PHEMT technology and offers extremely high dynamic range over a broad frequency range with low noise figure and flat gain. Lead finish is SnAgNi. It has repeatable performance from lot to lot and is enclosed in a SOT-89 package for very good thermal performance.

Key Features

Feature	Advantages
Broad Band: 5 to 250 MHz	Broadband covering CATV return path applications.
High IP3 Versus DC power Consumption: 34 dBm typical	The PGA-106R-75+ matches industry leading IP3 performance relative to device size and power consumption. The combination of the design and E-PHEMPT structure provides enhanced linearity over a broad frequency range as evidence in the IP3 being typically 15 dB above the P 1dB point. This feature makes this amplifier ideal for use in CATV applications.
High IP2, 62 dBm	Suppresses second order product on wideband applications such as CATV
Low Noise Figure: 3.3 dB at 50 - 250 MHz 6.0 dB at 10 MHz	Low noise figure performance in combination with the high output IP3 results in high dynamic range.

Notes

- A. Performance and quality attributes and conditions not expressly stated in this specification document are intended to be excluded and do not form a part of this specification document.
B. Electrical specifications and performance data contained in this specification document are based on Mini-Circuit's applicable established test performance criteria and measurement instructions.
C. The parts covered by this specification document are subject to Mini-Circuits standard limited warranty and terms and conditions (collectively, "Standard Terms"); Purchasers of this part are entitled to the rights and benefits contained therein. For a full statement of the Standard Terms and the exclusive rights and remedies thereunder, please visit Mini-Circuits' website at www.minicircuits.com/MCLStore/terms.jsp



75Ω Flat Gain, High Dynamic Range

Monolithic Amplifier

5-250 MHz

Product Features

- High IP3, 34 dBm typ.
- Gain, 17.9 dB typ.
- High Pout, P1dB 19.5 dBm typ.
- Excellent gain flatness, ± 0.1 dB typ.



Generic photo used for illustration purposes only

CASE STYLE: DF782

Typical Applications

- CATV Return path

PGA-106R-75+

+RoHS Compliant

The +Suffix identifies RoHS Compliance. See our web site for RoHS Compliance methodologies and qualifications

General Description

PGA-106R-75+ (RoHS compliant) is an advanced wideband amplifier fabricated using E-PHEMT* technology and offers extremely high dynamic range over a broad frequency range and with low noise figure and flat gain. In addition, the PGA-106R-75+ has excellent input and output return loss over a broad frequency range. Lead finish is SnAgNi. It has repeatable performance from lot to lot and is enclosed in a SOT-89 package for very good thermal performance.

simplified schematic and pin description

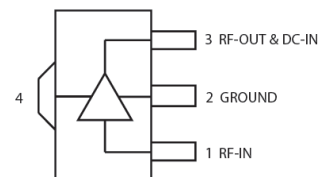
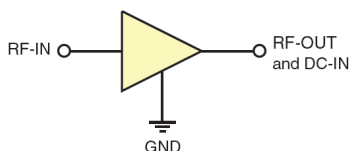

Function	Pin Number	Description
RF IN	1	RF input pin. This pin requires the use of an external DC blocking capacitor chosen for the frequency of operation.
RF-OUT and DC-IN	3	RF output and bias pin. DC voltage is present on this pin; therefore a DC blocking capacitor is necessary for proper operation. An RF choke is needed to feed DC bias without loss of RF signal due to the bias connection, as shown in "Recommended Application Circuit", Fig. 2
GND	2,4	Connections to ground. Use via holes as shown in "Suggested Layout for PCB Design" to reduce ground path inductance for best performance.

*Enhanced mode pseudomorphic High Electron Mobility Transistor.

Notes

- Performance and quality attributes and conditions not expressly stated in this specification document are intended to be excluded and do not form a part of this specification document.
- Electrical specifications and performance data contained in this specification document are based on Mini-Circuit's applicable established test performance criteria and measurement instructions.
- The parts covered by this specification document are subject to Mini-Circuits standard limited warranty and terms and conditions (collectively, "Standard Terms"); Purchasers of this part are entitled to the rights and benefits contained therein. For a full statement of the Standard Terms and the exclusive rights and remedies thereunder, please visit Mini-Circuits' website at www.minicircuits.com/MCLStore/terms.jsp



www.minicircuits.com P.O. Box 350166, Brooklyn, NY 11235-0003 (718) 934-4500 sales@minicircuits.com

REV. A
M151107
PGA-106R-75+
TH/RS/CP
150924
Page 2 of 5

Electrical Specifications⁽¹⁾ at 25°C, 75Ω and 5.0V, unless noted

Parameter	Condition (MHz)	Min.	Typ.	Max.	Units
Frequency Range		5		250	MHz
Gain	5 - 250	16.3	17.9	19.9	dB
Gain Flatness (±)	5 - 250		0.1		dB
Input Return Loss	5 - 250		15.3		dB
Output Return Loss	5 - 250		19.0		dB
Reverse Isolation	5 - 250		23.4		dB
Output Power @ 1dB compression	5 - 250		19.5		dBm
Output IP3	5 - 250		34.4		dBm
Output IP2 ⁽²⁾	5 - 250		62.0		dBm
Noise Figure	10	—	6.0	—	dB
	50	—	3.3	—	
	250	—	3.1	—	
Device Operating Voltage (Vd)		4.8	5.0	5.2	V
Device Operating Current		—	116	132	mA
Device Current Variation vs. Temperature ⁽⁴⁾			97		μA/°C
Device Current Variation vs Voltage			0.05		mA/mV
Thermal Resitance ⁽³⁾			76		°C/W

⁽¹⁾ Measured on Mini-Circuits Characterization Test board TB-587+. See Characterization Test Circuit (Fig. 1)

⁽²⁾ Output IP2 measured at sum frequency of the two tones (f meas= f1+f2).

⁽³⁾ Junction to ground lead.

⁽⁴⁾ (Current at 85°C - Current at -45°C)/130

Absolute Maximum Ratings

Parameter	Ratings
Operating Temperature (ground lead)	-40°C to 85°C
Storage Temperature	-65°C to 150°C
Operating Current at 5.0V	170 mA
Power Dissipation	0.85 W
Input Power (CW)	+23 dBm (5 minutes) +14 dBm (continuous)
DC Voltage on Pin 3	6 V

Permanent damage may occur if any of these limits are exceeded.
Electrical maximum ratings are not intended for continuous normal operation.

Notes

- A. Performance and quality attributes and conditions not expressly stated in this specification document are intended to be excluded and do not form a part of this specification document.
- B. Electrical specifications and performance data contained in this specification document are based on Mini-Circuit's applicable established test performance criteria and measurement instructions.
- C. The parts covered by this specification document are subject to Mini-Circuits standard limited warranty and terms and conditions (collectively, "Standard Terms"); Purchasers of this part are entitled to the rights and benefits contained therein. For a full statement of the Standard Terms and the exclusive rights and remedies thereunder, please visit Mini-Circuits' website at www.minicircuits.com/MCLStore/terms.jsp

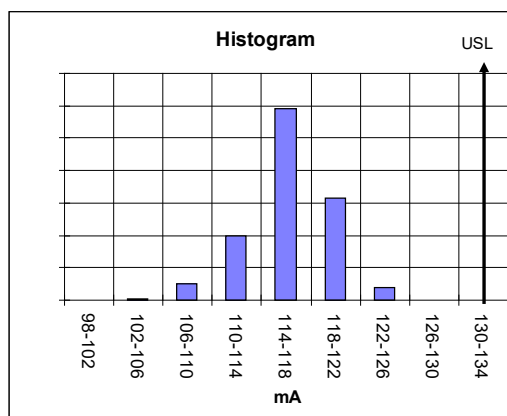

Characterization Test Circuit

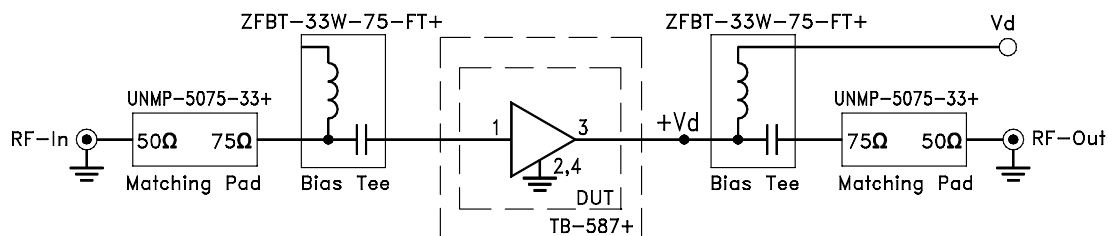

Fig 1. Block Diagram of Test Circuit used for characterization. (DUT tested on Mini-Circuits Characterization test board TB-587+) Gain, Return loss, Output power at 1dB compression (P1 dB) , output IP3 (OIP3), output IP2 (OIP2) and noise figure measured using Agilent's N5242A PNA-X microwave network analyzer.

Conditions:

1. Gain and Return loss: Pin= -25dBm
2. Output IP3 (OIP3): Two tones, spaced 1 MHz apart, 5 dBm/tone at output.
3. Output IP2 (OIP2): Two tones, spaced 1 MHz apart, 5 dBm/tone at output.

Recommended Application Circuit

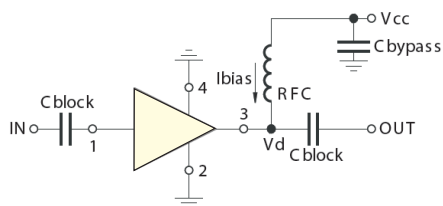
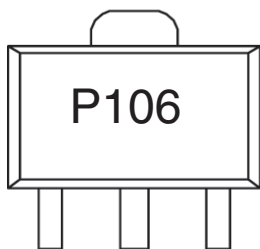

Fig 2. Evaluation board includes case, connectors, and components soldered to PCB

Product Marking



Marking may contain other features or characters for internal lot control

Notes

- A. Performance and quality attributes and conditions not expressly stated in this specification document are intended to be excluded and do not form a part of this specification document.
- B. Electrical specifications and performance data contained in this specification document are based on Mini-Circuit's applicable established test performance criteria and measurement instructions.
- C. The parts covered by this specification document are subject to Mini-Circuits standard limited warranty and terms and conditions (collectively, "Standard Terms"); Purchasers of this part are entitled to the rights and benefits contained therein. For a full statement of the Standard Terms and the exclusive rights and remedies thereunder, please visit Mini-Circuits' website at www.minicircuits.com/MCLStore/terms.jsp



Additional Detailed Technical Information	
additional information is available on our dash board. To access this information click here	
Performance Data	Data Table
	Swept Graphs
	S-Parameter (S2P Files) Data Set (.zip file)
Case Style	DF782 (SOT 89) <i>Plastic package, exposed paddle lead finish: tin-silver over nickel</i>
Tape & Reel Standard quantities available on reel	F55 <i>7" reels with 20, 50, 100, 200, 500 or 1K devices</i>
Suggested Layout for PCB Design	PL-384
Evaluation Board	TB-699+
Environmental Ratings	ENV08T1

ESD Rating

Human Body Model (HBM): Class 1B (500<1000) in accordance with ANSI/ESD STM 5.1 - 2001

Machine Model (MM): Class class M1 (50V) in accordance with ANSI/ESD STM5.2-1999

MSL Rating

Moisture Sensitivity: MSL1 in accordance with IPC/JEDEC J-STD-020D

MSL Test Flow Chart

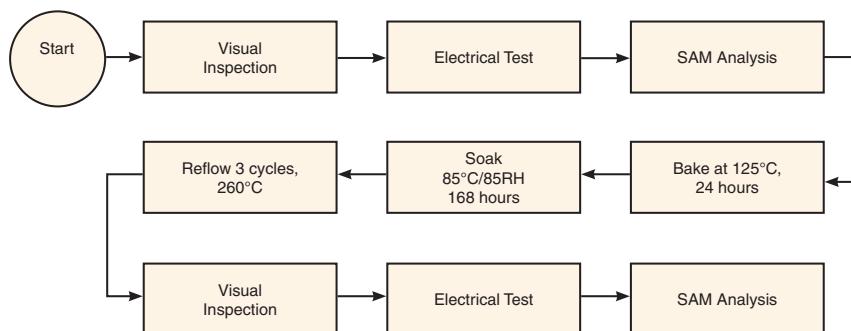

Notes

- A. Performance and quality attributes and conditions not expressly stated in this specification document are intended to be excluded and do not form a part of this specification document.
- B. Electrical specifications and performance data contained in this specification document are based on Mini-Circuit's applicable established test performance criteria and measurement instructions.
- C. The parts covered by this specification document are subject to Mini-Circuits standard limited warranty and terms and conditions (collectively, "Standard Terms"); Purchasers of this part are entitled to the rights and benefits contained therein. For a full statement of the Standard Terms and the exclusive rights and remedies thereunder, please visit Mini-Circuits' website at www.minicircuits.com/MCLStore/terms.jsp



Mouser Electronics

Authorized Distributor

Click to View Pricing, Inventory, Delivery & Lifecycle Information:

[Mini-Circuits:](#)

[PGA-106R-75+](#)