



LTCC SURFACE MOUNT

# Low Pass Filter

## LFHK-1575+

50Ω

DC to 1575 MHz

### THE BIG DEAL

- Low Insertion Loss, Typ. 1.8 dB
- Passband Return Loss, Typ. 14 dB
- Stopband Rejection, Typ. 82 dB
- 1008 Surface Mount Footprint
- Power Handling: 10 W

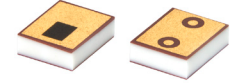

Generic photo used for illustration purposes only

### APPLICATIONS

- Harmonic Rejection and Spurious Cleanup
- Radar, EW, and ECM Defense Systems
- Satellite Communications
- Test and Measurement Equipment
- UHF Transmitters / Receivers

### FUNCTIONAL DIAGRAM

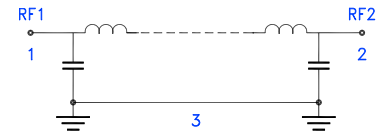

### PRODUCT OVERVIEW

Mini-Circuits' LFHK-1575+ is a miniature low temperature co-fired ceramic (LTCC) low pass filter with a DC to 1575 MHz passband supporting a variety of applications. This model provides 1.8 dB typical insertion loss over a wide band due to its rugged monolithic construction. Housed in a small 1008 ceramic form factor the filter is ideal for dense signal chain PCB layouts where it complements MMIC size and performance. The LTCC fabrication process assures minimal RF performance variation while delivering a product that is well suited for environmental extremes of high humidity and temperature.

### KEY FEATURES

Features	Advantages
Ultra-Wide Stopband	The LTCC lowpass filter provides a very good stopband rejection up to 50 GHz, suitable for wide band applications.
LTCC Construction	Provides repeatable performance in a rugged, ceramic package well suited for tough environments such as high humidity and temperature extremes.
Small Size, 1008	Saves space in dense circuit board layouts and minimizes the effects of parasitics.
Rugged Power Handling, 10 Watts	Handles up to 10 Watts in a small 1008 package.



### ELECTRICAL SPECIFICATIONS<sup>1,2,3</sup> AT +25°C

Parameter	F#	Frequency (MHz)	Min.	Typ.	Max.	Units	
Passband	Insertion Loss	DC-F1	DC - 1575	—	1.8	2.6	dB
	Freq. Cut-Off <sup>4</sup>	Fc	1700	—	3	—	dB
	Return Loss	DC-F1	DC - 1575	—	14	—	dB
Stopband	Rejection	F2-F3	2200 - 3600	20	35	—	dB
		F3-F4	3600 - 8500	64	82	—	
		F4-F5	8500 - 14000	30	52	—	
		F5-F6	14000 - 30000	20	41	—	
		F6-F7	30000 - 50000	—	23	—	

1. Tested on Evaluation Board P/N TB-LFHK-1575+ with connectors and feedline de-embedded with thru-line compensation.
2. This filter is bi-directional, RF1 and RF2 ports may be interchanged.
3. In applications where DC voltage and/or current is present at either the input or output ports, external DC blocking capacitors are required.
4. Typical variation ±5%.

### ABSOLUTE MAXIMUM RATINGS<sup>5</sup>

Parameter	Ratings
Operating Temperature	-55°C to +125°C
Storage Temperature	-55°C to +125°C
Input Power <sup>6</sup>	10 W @ +25°C

5. Permanent damage may occur if any of these limits are exceeded.
6. Power rating applies only to signals within the passband. Power rating above +25°C operating temperature decreases linearly to 1.5 W at +125°C.

### TYPICAL FREQUENCY RESPONSE AT +25°C

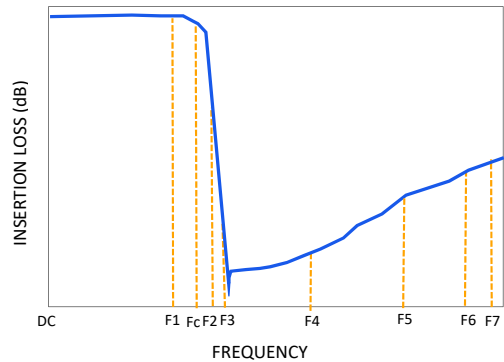



### TYPICAL PERFORMANCE GRAPHS

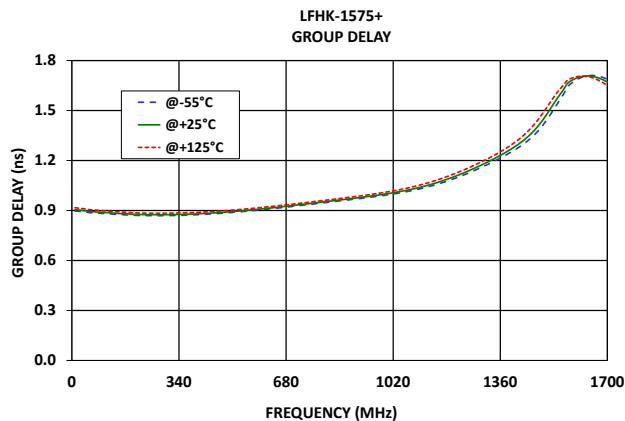
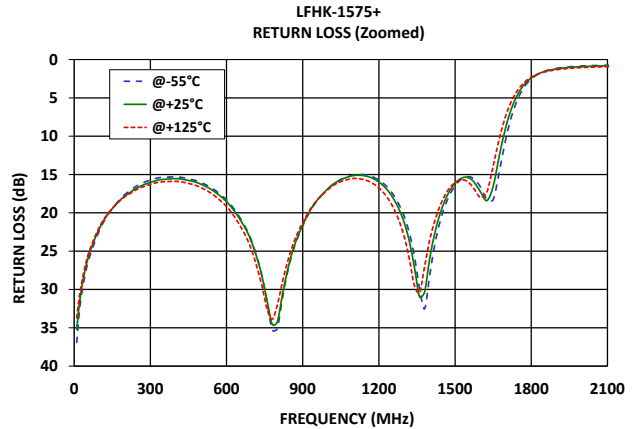
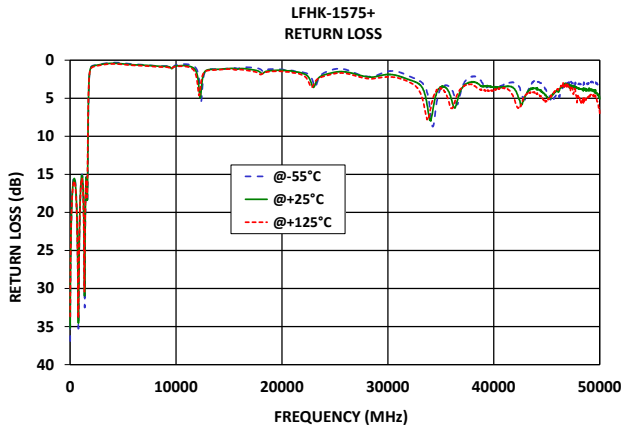
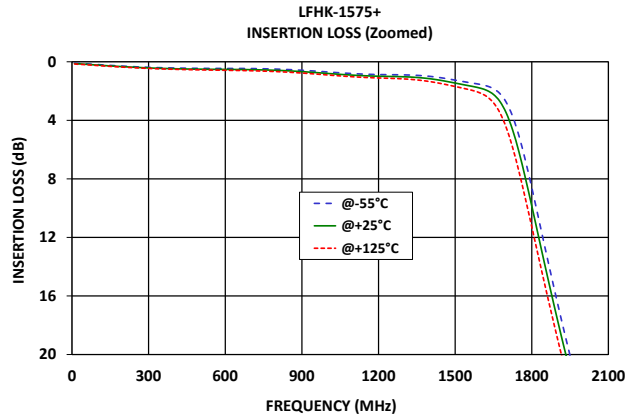
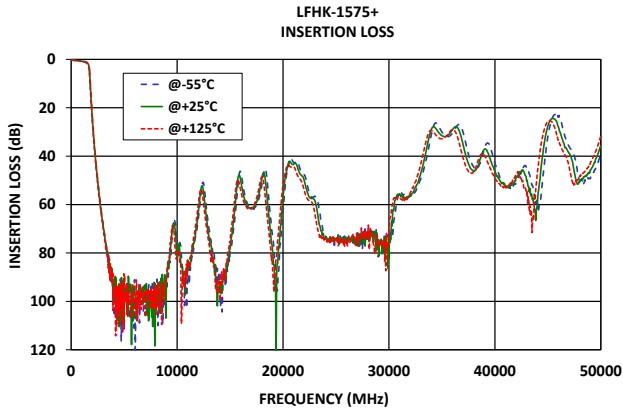



### FUNCTIONAL DIAGRAM

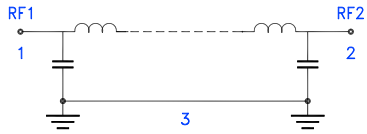
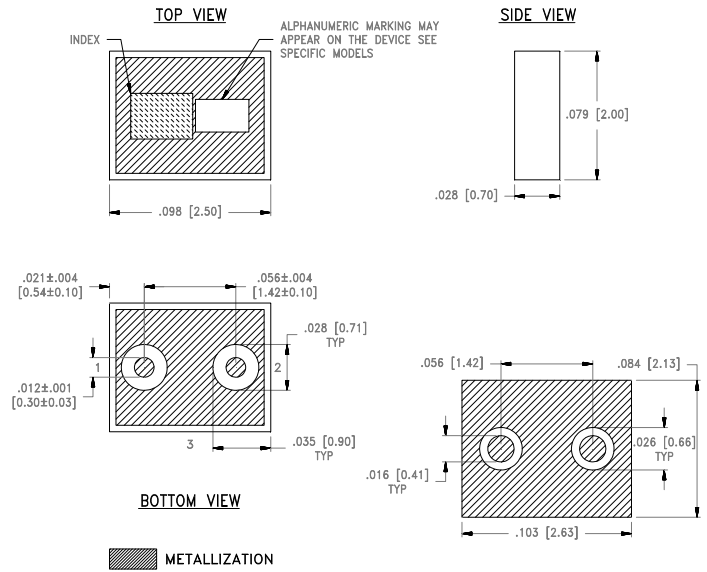

Figure 1. LFHK-1575+ Functional Diagram

### PAD DESCRIPTION

Function	Pad Number	Description
RF1 <sup>2</sup>	1	Connects to RF Input Port
RF2 <sup>2</sup>	2	Connects to RF Output Port
GROUND	3	Connects to Ground on PCB, (See drawing PL-798)
NC	-	No connection, not used internally. See drawing PL-798 for connection to PCB

### CASE STYLE DRAWING



Weight: .019 grams.

Dimensions are in inches (mm). Tolerances: 2Pl. ± .01; 3Pl. ± .005

### PRODUCT MARKING\*: ZY

\*Marking may contain other features or characters for internal lot control.



### SUGGESTED PCB LAYOUT (PL-798)

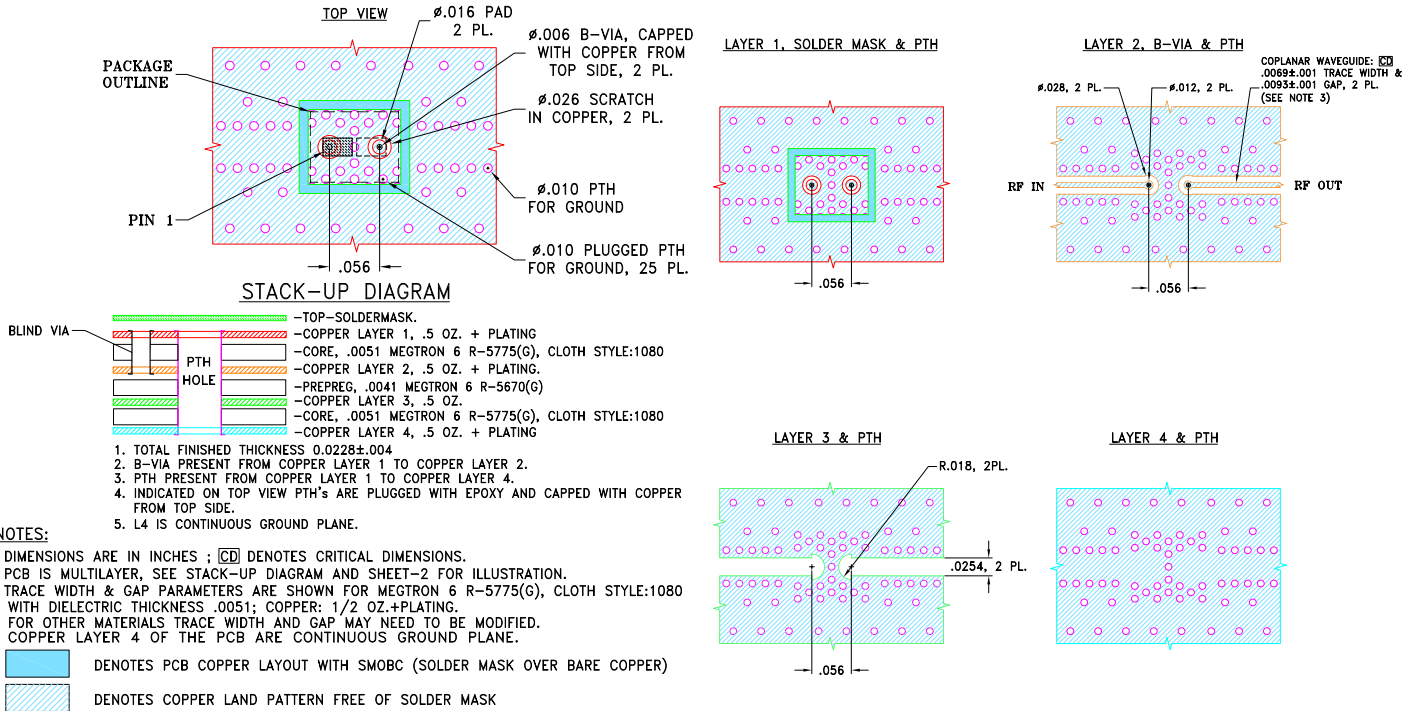

Figure 2. Suggested PCB Layout PL-798



LTCC SURFACE MOUNT

# Low Pass Filter

## LFHK-1575+

50Ω

DC to 1575 MHz

ADDITIONAL DETAILED INFORMATION IS AVAILABLE ON OUR DASHBOARD.

[CLICK HERE](#)

Performance Data and Graphs	Data Graphs S-Parameter (S2P Files) Data Set (.zip file) De-embedded to device pads
Case Style	NL1008C-9    Lead Finish: Gold over Electroless Nickel
RoHS Status	Compliant
Tape and Reel	TR-F75
Suggested Layout for PCB Design	PL-798
Evaluation Board	TB-LFHK-1575+
	Gerber File
Environmental Rating	ENV06T10

### NOTES

- A. Performance and quality attributes and conditions not expressly stated in this specification document are intended to be excluded and do not form a part of this specification document.
- B. Electrical specifications and performance data contained in this specification document are based on Mini-Circuits' applicable established test performance criteria and measurement instructions.
- C. The parts covered by this specification document are subject to Mini-Circuits' standard limited warranty and terms and conditions (collectively, "Standard Terms"); Purchasers of this part are entitled to the rights and benefits contained therein. For a full statement of the standard terms and the exclusive rights and remedies thereunder, please visit Mini-Circuits' website at [www.minicircuits.com/terms/viewterm.html](http://www.minicircuits.com/terms/viewterm.html)



# Mouser Electronics

Authorized Distributor

Click to View Pricing, Inventory, Delivery & Lifecycle Information:

[Mini-Circuits:](#)

[LFHK-1575+](#)