

SIDACtor® Series - DO-214



Agency Approvals

| AGENCY | AGENCY FILE NUMBER |
|--------|--------------------|
| | E133083 |

Pinout Designation

Not Applicable

Schematic Symbol



Description

SIDACtor® Series DO-214AA are designed to protect baseband equipment such as modems, line cards, CPE and DSL from damaging overvoltage transients.

The series provides a surface mount solution that enables equipment to comply with global regulatory standards.

Features and Benefits

- Low voltage overshoot
- Low on-state voltage
- Does not degrade surge capability after multiple surge events within limit.
- Fails short circuit when surged in excess of ratings
- Low capacitance
- 2nd level interconnect is Pb-free per IPC/JEDEC J-STD-609A.01

Applicable Global Standards

- TIA-968-A
- TIA-968-B
- ITU K.20/21 Enhanced Level*
- ITU K.20/21 Basic Level
- GR 1089 Inter-building*
- GR 1089 Intra-building
- IEC 61000-4-5
- YD/T 1082
- YD/T 993
- YD/T 950

*A/B-rated parts require series resistance

Electrical Characteristics

| Part Number | Marking | V_{DRM} @ $I_{DRM}=5\mu A$ | V_S @ 100V/ μs | I_H | I_S | I_T | V_T @ $I_T=2.2$ Amps | Capacitance @ 1MHz, 2V bias | |
|-------------|---------|---------------------------------|--------------------------|--------|--------|-------|---------------------------|--------------------------------|--------|
| | | V min | V max | mA min | mA max | A max | V max | pF min | pF max |
| P0080SALRP | P-8A | 6 | 25 | 50 | 800 | 2.2 | 4 | 25 | 35 |
| P0220SALRP | P22A | 15 | 32 | 50 | 800 | 2.2 | 4 | 25 | 150 |
| P0300SALRP | P03A | 25 | 40 | 50 | 800 | 2.2 | 4 | 15 | 140 |
| P0640SALRP | P06A | 58 | 77 | 150 | 800 | 2.2 | 4 | 40 | 60 |
| P0720SALRP | P07A | 65 | 88 | 150 | 800 | 2.2 | 4 | 35 | 60 |
| P0900SALRP | P09A | 75 | 98 | 150 | 800 | 2.2 | 4 | 25 | 55 |
| P1100SALRP | P11A | 90 | 130 | 150 | 800 | 2.2 | 4 | 30 | 50 |
| P1300SALRP | P13A | 120 | 160 | 150 | 800 | 2.2 | 4 | 25 | 45 |
| P1500SALRP | P15A | 140 | 180 | 150 | 800 | 2.2 | 4 | 25 | 40 |
| P1800SALRP | P18A | 170 | 220 | 150 | 800 | 2.2 | 4 | 25 | 35 |
| P2100SALRP | P21A | 180 | 240 | 150 | 800 | 2.2 | 4 | 20 | 35 |
| P2300SALRP | P23A | 190 | 260 | 150 | 800 | 2.2 | 4 | 25 | 35 |
| P2600SALRP | P26A | 220 | 300 | 150 | 800 | 2.2 | 4 | 20 | 35 |
| P3100SALRP | P31A | 275 | 350 | 150 | 800 | 2.2 | 4 | 15 | 50 |
| P3500SALRP | P35A | 320 | 400 | 150 | 800 | 2.2 | 4 | 15 | 50 |
| P0080SBLRP | P-8B | 6 | 25 | 50 | 800 | 2.2 | 4 | 25 | 150 |
| P0220SBLRP | P22B | 15 | 32 | 50 | 800 | 2.2 | 4 | 25 | 150 |
| P0300SBLRP | P03B | 25 | 40 | 50 | 800 | 2.2 | 4 | 15 | 140 |
| P0640SBLRP | P06B | 58 | 77 | 150 | 800 | 2.2 | 4 | 40 | 80 |
| P0720SBLRP | P07B | 65 | 88 | 150 | 800 | 2.2 | 4 | 35 | 75 |

Table continues on next page.

Electrical Parameters (continued)

| Part Number | Marking | V_{DRM} @ $I_{DRM}=5\mu A$ | V_S @ 100V/ μs | I_H | I_S | I_T | V_T @ $I_T=2.2$ Amps | Capacitance @ 1MHz, 2V bias | |
|---------------|---------|---------------------------------|--------------------------|--------|--------|-------|---------------------------|--------------------------------|--------|
| | | V min | V max | mA min | mA max | A max | V max | pF min | pF max |
| P0900SBLRP | P09B | 75 | 98 | 150 | 800 | 2.2 | 4 | 35 | 70 |
| P1100SBLRP | P11B | 90 | 130 | 150 | 800 | 2.2 | 4 | 30 | 70 |
| P1300SBLRP | P13B | 120 | 160 | 150 | 800 | 2.2 | 4 | 25 | 60 |
| P1500SBLRP | P15B | 140 | 180 | 150 | 800 | 2.2 | 4 | 25 | 55 |
| P1800SBLRP | P18B | 170 | 220 | 150 | 800 | 2.2 | 4 | 25 | 50 |
| P2100SBLRP | P21B | 180 | 240 | 150 | 800 | 2.2 | 4 | 20 | 35 |
| P2300SBLRP | P23B | 190 | 260 | 150 | 800 | 2.2 | 4 | 25 | 50 |
| P2600SBLRP | P26B | 220 | 300 | 150 | 800 | 2.2 | 4 | 20 | 45 |
| P3100SBLRP | P31B | 275 | 350 | 150 | 800 | 2.2 | 4 | 20 | 45 |
| P3500SBLRP | P35B | 320 | 400 | 150 | 800 | 2.2 | 4 | 20 | 40 |
| P4500SBLRP | P45B | 400 | 530 | 150 | 800 | 2.2 | 4 | 20 | 65 |
| P0080SCLRP | P-8C | 6 | 25 | 50 | 800 | 2.2 | 4 | 45 | 260 |
| P0220SCLRP | P22C | 15 | 32 | 50 | 800 | 2.2 | 4 | 30 | 240 |
| P0300SCLRP | P03C | 25 | 40 | 50 | 800 | 2.2 | 4 | 25 | 250 |
| P0640SCLRP | P06C | 58 | 77 | 150 | 800 | 2.2 | 4 | 55 | 155 |
| P0720SCLRP | P07C | 65 | 88 | 150 | 800 | 2.2 | 4 | 50 | 150 |
| P0900SCLRP | P09C | 75 | 98 | 150 | 800 | 2.2 | 4 | 45 | 140 |
| P1100SCLRP | P11C | 90 | 130 | 150 | 800 | 2.2 | 4 | 45 | 115 |
| P1300SCLRP | P13C | 120 | 160 | 150 | 800 | 2.2 | 4 | 40 | 105 |
| P1500SCLRP | P15C | 140 | 180 | 150 | 800 | 2.2 | 4 | 35 | 95 |
| P1800SCLRP | P18C | 170 | 220 | 150 | 800 | 2.2 | 4 | 35 | 90 |
| P2100SCLRP | P21C | 180 | 240 | 150 | 800 | 2.2 | 4 | 30 | 90 |
| P2300SCLRP | P23C | 190 | 260 | 150 | 800 | 2.2 | 4 | 30 | 80 |
| P2600SCLRP | P26C | 220 | 300 | 150 | 800 | 2.2 | 4 | 30 | 80 |
| P3100SCLRP | P31C | 275 | 350 | 150 | 800 | 2.2 | 4 | 30 | 70 |
| P3500SCLRP | P35C | 320 | 400 | 150 | 800 | 2.2 | 4 | 25 | 65 |
| P4500SCLRP | P45C | 400 | 530 | 150 | 800 | 2.2 | 4 | 25 | 65 |
| P4500SCLHLRP* | P45L | 400 | 530 | 50 | 800 | 2.2 | 4 | 20 | 65 |

Notes:
 - Absolute maximum ratings measured at $T_A=25^\circ C$ (unless otherwise noted).
 - Devices are bi-directional.
 - * P4500SCLHLRP is low IH product

Surge Ratings

| Series | I_{PP} | | | | | | | | | I_{TSM} 50/60 Hz | di/dt |
|--------|--|--|--|--|--|--|--|--|---|-----------------------|-------|
| | 0.2x310 ¹ 0.5x700 ² | 2x10 ¹ 2x10 ² | 8x20 ¹ 1.2x50 ² | 10x160 ¹ 10x160 ² | 10x560 ¹ 10x560 ² | 5x320 ¹ 9x720 ² | 10x360 ¹ 10x360 ² | 10x1000 ¹ 10x1000 ² | 5x310 ¹ 10x700 ² | | |
| | A min | A min | A min | A min | A min | A min | A min | A min | A min | | |
| A | 20 | 150 | 150 | 90 | 50 | 75 | 75 | 45 | 75 | 20 | 500 |
| B | 25 | 250 | 250 | 150 | 100 | 100 | 125 | 80 | 100 | 25 | 500 |
| C | 50 | 500 | 400 | 200 | 150 | 200 | 175 | 100 | 200 ³ | 30 | 500 |

Notes:
 1 Current waveform in μs
 2 Voltage waveform in μs
 3 For surge rating of P4500SCLRP 10x700 μs min=150A & typical=180A
 For surge rating of P4500SCLHLRP 10x700 μs min=150A
 - Peak pulse current rating (I_{pp}) is repetitive and guaranteed for the life of the product.
 - I_{pp} ratings applicable over temperature range of $-40^\circ C$ to $+85^\circ C$
 - The device must initially be in thermal equilibrium with $-40^\circ C \leq T_j \leq +150^\circ C$

Thermal Considerations

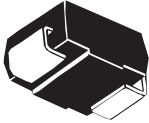
| Package | Symbol | Parameter | Value | Unit |
|---|-----------------|---|-------------|------|
|  DO-214AA | T_J | Operating Junction Temperature Range | -40 to +150 | °C |
| | T_S | Storage Temperature Range | -65 to +150 | °C |
| | $R_{\theta JA}$ | Thermal Resistance: Junction to Ambient | 90 | °C/W |

V-I Characteristics

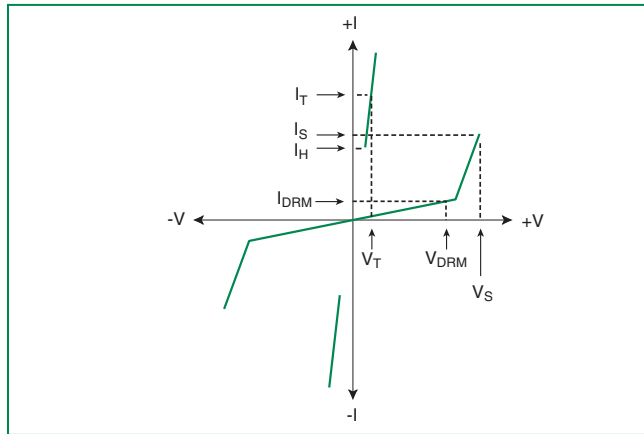

$t_r \times t_d$ Pulse Waveform

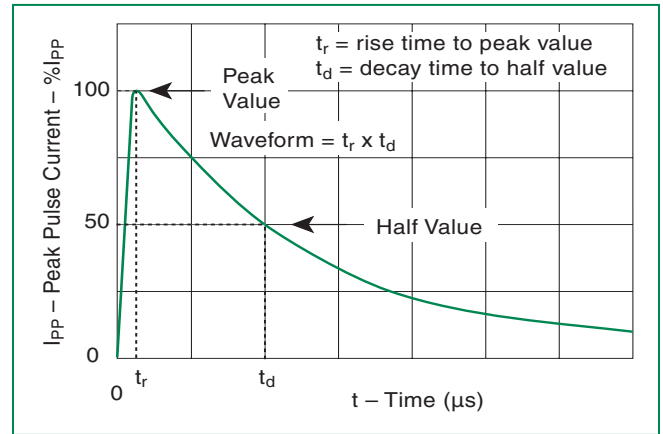

Normalized V_S Change vs. Junction Temperature

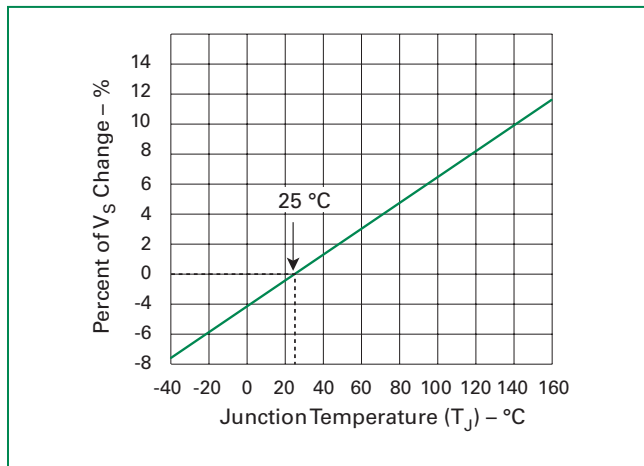

Normalized DC Holding Current vs. Case Temperature

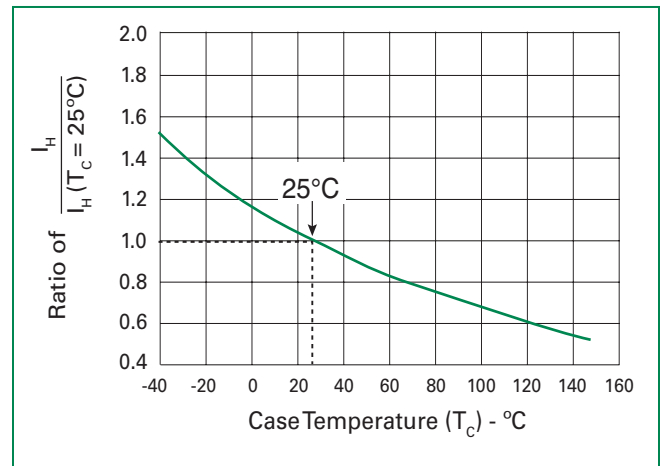

Soldering Parameters

| | | |
|---|-----------------------------------|--------------|
| Reflow Condition | Pb-Free assembly (see Fig. 1) | |
| Pre Heat | -Temperature Min ($T_{s(min)}$) | +150°C |
| | -Temperature Max ($T_{s(max)}$) | +200°C |
| | -Time (Min to Max) (t_s) | 60-180 secs. |
| Average ramp up rate (LiquidusTemp (T_L) to peak) | 3°C/sec. Max. | |
| $T_{s(max)}$ to T_L - Ramp-up Rate | 3°C/sec. Max. | |
| Reflow | -Temperature (T_L) (Liquidus) | +217°C |
| | -Temperature (t_L) | 60-150 secs. |
| Peak Temp (T_p) | +260(+0/-5)°C | |
| Time within 5°C of actual PeakTemp (t_p) | 30 secs. Max. | |
| Ramp-down Rate | 6°C/sec. Max. | |
| Time 25°C to Peak Temp (T_p) | 8 min. Max. | |
| Do not exceed | +260°C | |

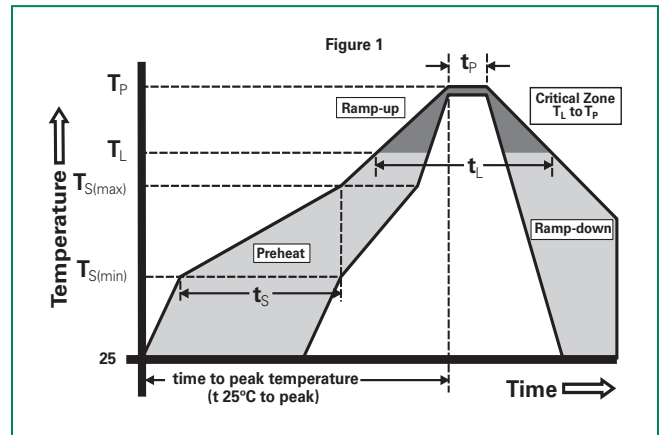

Physical Specifications

| | |
|-----------------|---|
| Lead Material | Copper Alloy |
| Terminal Finish | 100% Matte-Tin Plated |
| Body Material | UL recognized epoxy meeting flammability classification 94V-0 |

Environmental Specifications

| | |
|----------------------------------|--|
| High Temp Voltage Blocking | 80% Rated V_{DRM} ($V_{AC Peak}$) +125°C or +150°C, 504 or 1008 hrs. MIL-STD-750 (Method 1040) JEDEC, JESD22-A-101 |
| Temp Cycling | -65°C to +150°C, 15 min. dwell, 10 up to 100 cycles. MIL-STD-750 (Method 1051) EIA/JEDEC, JESD22-A104 |
| Biased Temp & Humidity | 52 V_{DC} (+85°C) 85%RH, 504 up to 1008 hrs. EIA/JEDEC, JESD22-A-101 |
| High Temp Storage | +150°C 1008 hrs. MIL-STD-750 (Method 1031) JEDEC, JESD22-A-101 |
| Low Temp Storage | -65°C, 1008 hrs. |
| Thermal Shock | 0°C to +100°C, 5 min. dwell, 10 sec. transfer, 10 cycles. MIL-STD-750 (Method 1056) JEDEC, JESD22-A-106 |
| Autoclave (Pressure Cooker Test) | +121°C, 100%RH, 2atm, 24 up to 168 hrs. EIA/JEDEC, JESD22-A-102 |
| Resistance to Solder Heat | +260°C, 30 secs. MIL-STD-750 (Method 2031) |
| Moisture Sensitivity Level | 85%RH, +85°C, 168 hrs., 3 reflow cycles (+260°C Peak). JEDEC-J-STD-020, Level 1 |

Part Numbering

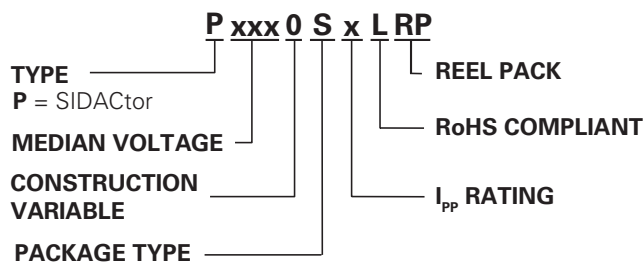

Part Marking

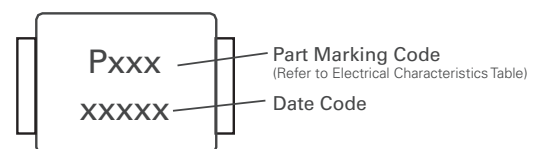

Dimensions – DO-214AA

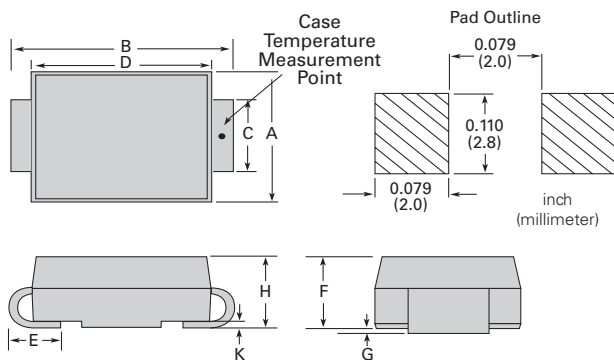

| Dimensions | Inches | | Millimeters | |
|-----------------|--------|-------|-------------|------|
| | Min | Max | Min | Max |
| A | 0.130 | 0.156 | 3.30 | 3.95 |
| B | 0.201 | 0.220 | 5.10 | 5.60 |
| C | 0.077 | 0.087 | 1.95 | 2.20 |
| D | 0.159 | 0.181 | 4.05 | 4.60 |
| E | 0.030 | 0.063 | 0.75 | 1.60 |
| F | 0.075 | 0.096 | 1.90 | 2.45 |
| G | 0.002 | 0.008 | 0.05 | 0.20 |
| H | 0.077 | 0.104 | 1.95 | 2.65 |
| H- P4500SCLHRLP | 0.077 | 0.096 | 1.95 | 2.43 |
| K | 0.006 | 0.016 | 0.15 | 0.41 |

Packing Options

| Package Type | Description | Quantity | Added Suffix | Industry Standard |
|--------------|------------------------------|----------|--------------|-------------------|
| S | DO-214AA Tape & Reel Pack | 2500 | RP | EIA-481-D |

Tape and Reel Specification – DO-214AA

