

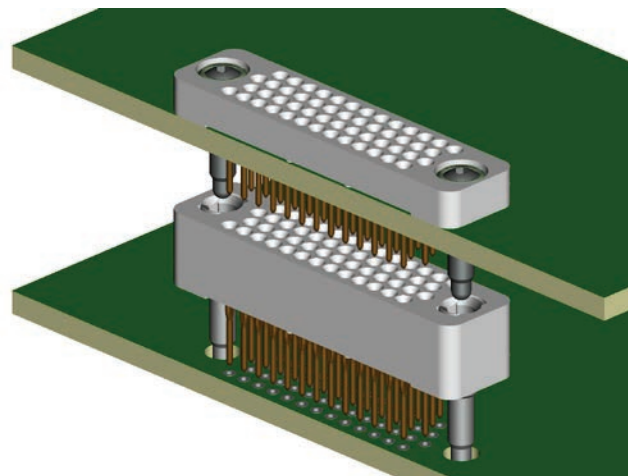

## IRRC™

The AirBorn stackable compliant connector family is one of AirBorn's solutions for high-density, board-to-board stacking applications. This connector family is available in 0.075" contact spacing and 100  $\Omega$  and 85  $\Omega$  differential serial buses.

- Wide variety of standard pin/tail lengths accommodate any board-to-board spacing
- 0.075" contact spacing
- Reliable "eye of the needle"-compliant section design eliminates soldering
- BeCu contacts (special high-conductivity, high-temperature alloy)
- Very robust socket contact (low-stress design)
- Individually repairable contacts





## RC422 - Full Profile Board-to-Board Stackable Connector

Contact spacing: 0.075" (1.91 mm)

A full bodied high-density press-fit connector. Uses a patented female/compliant/male stacking contact system. Used in board-to-board stacking applications.

### DIMENSIONS

SIZE	A	B	C
28	1.014	0.784	0.450
52	1.464	1.234	0.900
76	1.914	1.684	1.350
100	2.364	2.134	1.800
128	2.889	2.659	2.325
152	3.339	3.109	2.775
200	4.239	4.009	3.675
252	5.214	4.984	4.650
300	6.114	5.884	5.550

Tolerances: ± 0.010"

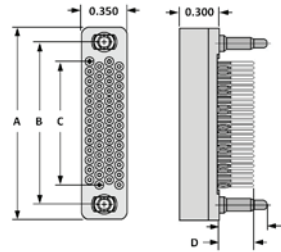

CONTACT SELECTION	CONTACT D	HARDWARE E
10	0.095	0.195
20	0.270	0.370
21	0.300	0.400
22	0.400	0.500
23	0.500	0.600
24	0.700	0.800
25	0.800	0.900
26	0.900	1.000
27	0.600	0.700
28	1.000	1.100

### Sample Part Number Format: RC422-052-211-4000



**SERIES**  
 Stackable  
 Compliant  
 Full-Profile  
 4 Rows  
 0.075" Spacing



**CONFIGURATION**  
 028 – 4 Rows/7 Columns  
 052 – 4 Rows/13 Columns  
 076 – 4 Rows/19 Columns  
 100 – 4 Rows/25 Columns  
 128 – 4 Rows/32 Columns  
 152 – 4 Rows/38 Columns  
 200 – 4 Rows/50 Columns  
 252 – 4 Rows/63 Columns  
 300 – 4 Rows/75 Columns



**PLATING**  
 1 – 50 μ" Au  
 3 – 30 μ" Au  
 7 – 50 μ" Au / 20 μ" Au  
 9 – 30 μ" Au / 20 μ" Au

**CONTACT**  
 10 – 0.095" Long  
 20 – 0.270" Long  
 21 – 0.300" Long  
 22 – 0.400" Long  
 23 – 0.500" Long  
 24 – 0.700" Long  
 25 – 0.800" Long  
 26 – 0.900" Long  
 27 – 0.600" Long  
 28 – 1.000" Long  
 30 – 0.270" Long  
 31 – 0.300" Long  
 32 – 0.400" Long  
 33 – 0.500" Long  
 34 – 0.700" Long  
 35 – 0.800" Long  
 36 – 0.900" Long  
 37 – 0.600" Long  
 38 – 1.000" Long



**TYPE**  
 00 – None  
 FT – Female thread  
 MT – Male thread  
 (#39 hardware, only)

**HARDWARE**  
 30 – 0.195" Long (use with #10 contact)  
 39 – 0.370" Long (use with #20 contact)  
 40 – 0.400" Long (use with #21 contact)  
 41 – 0.500" Long (use with #22 contact)  
 42 – 0.600" Long (use with #23 contact)  
 43 – 0.800" Long (use with #24 contact)  
 44 – 0.900" Long (use with #25 contact)  
 45 – 1.000" Long (use with #26 contact)  
 46 – 0.700" Long (use with #27 contact)  
 47 – 1.100" Long (use with #28 contact)



**VARIATION**  
 Blank – None  
 XXX – Consult factory



PLEASE CONSULT THE AIRBORN WEBSITE FOR THE LATEST REVISION OF THIS DOCUMENT PRIOR TO BEGINNING ANY DESIGN WORK.

### MATED HEIGHT

The connector body height is 0.300" and, when used with the -20 or -30 (0.270") contact, the mounting is flush (board-bottom-mounted to connector top). This board-bottom to connector-top spacing can be modified based on the contact selected by approximately the difference in pin length (see Table 2 in top window).

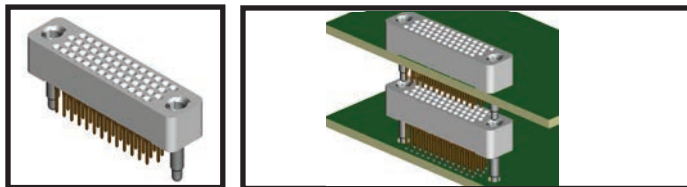

1	Diff. Insertion Loss	5.0 GHz @ -3 dB
2	Diff. Return Loss	2.0 GHz @ -8 dB
3	NEXT	4.0 GHz @ -25 dB
4	FEXT	4.0 GHz @ -35 dB

### MATERIALS and FINISHES

Contact: ..... BeCu per ASTM B768 (BeCu C17410 brush alloy 174)  
 Contact Finish: ..... Gold per MIL-G-45204 over nickel per IAW QQ-N-290  
 Molded Insulator: ..... Glass-filled polyphenylene sulfide (PPS) per MIL-M-24519  
 Hardware: ..... Stainless steel per ASTM A582, passivated per ASTM 967  
 Guide Pin/Socket: ..... BeCu per ASTM B196/197, nickel-plated per QQ-N-290

NOTE: AirBorn can manufacture special configurations to your exact specifications.

### PERFORMANCE

Contact Rating: ..... 3 amperes  
 Operating Temperature: ..... -65° C to +125° C  
 Insulation Resistance: ..... 5,000 megaohms minimum @ 500 VDC  
 Durability: ..... 500 connector mating cycles  
 Contact Resistance: ..... 3 to 5 milliohms (contact length-dependent)  
 Contact Engagement Force: ..... 4.0 oz (113 g) max. w/0.0246" dia. test pin  
 Contact Separation Force: ..... 0.5 oz (14 g) min. w/0.0226" dia. test pin  
 Compliant Insertion Force: ..... 22.5 lb (10.21 Kg) max. per contact  
 Compliant Removal Force: ..... 4.5 lb (2.04 Kg) min. per contact



## RC422 - Bottom-of-Stack Board Mount Connector

Contact spacing: 0.075" (1.91 mm)

A full bodied high-density press-fit connector. Uses a patented female/compliant/male stacking contact system. Used at the bottom of the stack in board-to-board stacking applications.

### DIMENSIONS

TABLE 1			
SIZE	A	B	C
28	1.014	0.784	0.450
52	1.464	1.234	0.900
76	1.914	1.684	1.350
100	2.364	2.134	1.800
128	2.889	2.659	2.325
152	3.339	3.109	2.775
200	4.239	4.009	3.675
252	5.214	4.984	4.650
300	6.114	5.884	5.550

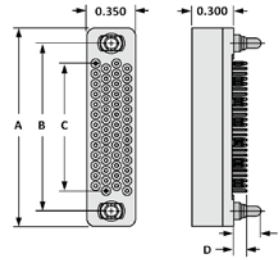

TABLE 2		
CONTACT SELECTION	CONTACT D	HARDWARE E
10	0.095	0.195

Tolerances: ± 0.010"

### Sample Part Number Format: RC422-052-101-3000



**SERIES**  
 Stackable  
 Compliant  
 Full-Profile  
 4 Rows  
 0.075" Spacing



**CONFIGURATION**  
 028 – 4 Rows/7 Columns  
 052 – 4 Rows/13 Columns  
 076 – 4 Rows/19 Columns  
 100 – 4 Rows/25 Columns  
 128 – 4 Rows/32 Columns  
 152 – 4 Rows/38 Columns  
 200 – 4 Rows/50 Columns  
 252 – 4 Rows/63 Columns  
 300 – 4 Rows/75 Columns

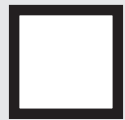

**CONTACT**  
 10 - 0.095" Long



**PLATING**  
 1 – 50 μ" Au  
 3 – 30 μ" Au  
 7 – 50 μ" Au / 20 μ" Au  
 9 – 30 μ" Au / 20 μ" Au



**HARDWARE**  
 30 - 0.195" Long  
 (use with #10 contact)



**TYPE**  
 00 – None  
 FT – Female thread



**VARIATION**  
 Blank – None  
 XXX – Consult factory



PLEASE CONSULT THE AIRBORN WEBSITE FOR THE LATEST REVISION OF THIS DOCUMENT PRIOR TO BEGINNING ANY DESIGN WORK.

### MATED HEIGHT

The connector body height is 0.300" and, when used with the -20 or -30 (0.270") contact, the mounting is flush (board-bottom-mounted to connector top). This board-bottom to connector-top spacing can be modified based on the contact selected by approximately the difference in pin length (see Table 2 in top window).

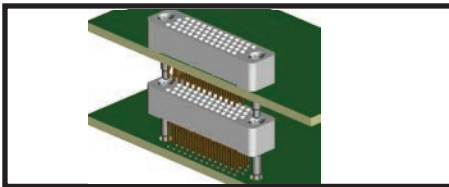
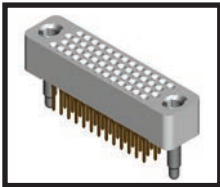

### MATERIALS and FINISHES

Contact: .....BeCu per ASTM B768 (BeCu C17410 brush alloy 174)  
 Contact Finish: ..... Gold per MIL-G-45204 over nickel per IAW QQ-N-290  
 Molded Insulator: ..... Glass-filled polyphenylene sulfide (PPS) per MIL-M-24519  
 Hardware: ..... Stainless steel per ASTM A582, passivated per ASTM 967  
 Guide Pin/Socket: ..... BeCu per ASTM B196/197, nickel-plated per QQ-N-290

NOTE: AirBorn can manufacture special configurations to your exact specifications.

### PERFORMANCE

Contact Rating: ..... 3 amperes  
 Operating Temperature: ..... -65° C to +125° C  
 Insulation Resistance: ..... 5,000 megaohms minimum @ 500 VDC  
 Durability: ..... 500 connector mating cycles  
 Contact Resistance: ..... 3 to 5 milliohms (contact length-dependent)  
 Contact Engagement Force: ..... 4.0 oz (113 g) max. w/0.0246" dia. test pin  
 Contact Separation Force: ..... 0.5 oz (14 g) min. w/0.0226" dia. test pin  
 Compliant Insertion Force: ..... 22.5 lb (10.21 Kg) max. per contact  
 Compliant Removal Force: ..... 4.5 lb (2.04 Kg) min. per contact

### SI DATA – Differential 100 Ohm

1	Diff. Insertion Loss	5.0 GHz @ -3 dB
2	Diff. Return Loss	2.0 GHz @ -8 dB
3	NEXT	4.0 GHz @ -25 dB
4	FEXT	4.0 GHz @ -35 dB



## RC442 - Low Profile Board-to-Board Stackable Connector

Contact spacing: 0.075" (1.91 mm)

A low profile bodied, high-density press-fit connector. Uses a patented female/compliant/male stacking contact system. Used in board-to-board stacking applications.

### DIMENSIONS

SIZE	A	B	C
28	1.014	0.784	0.450
52	1.464	1.234	0.900
76	1.914	1.684	1.350
100	2.364	2.134	1.800
128	2.889	2.659	2.325
152	3.339	3.109	2.775
200	4.239	4.009	3.675
252	5.214	4.984	4.650
300	6.114	5.884	5.550

Tolerances: ± 0.010"

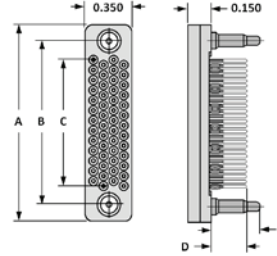

CONTACT SELECTION	CONTACT D	HARDWARE E
30	0.270	0.370
31	0.300	0.400
32	0.400	0.500
33	0.500	0.600
34	0.700	0.800
35	0.800	0.900
36	0.900	1.000
37	0.600	0.700
38	1.000	1.100

### Sample Part Number Format: RC442-052-311-4000



**SERIES**  
 Stackable  
 Compliant  
 Low-Profile  
 4 Rows  
 0.075" Spacing

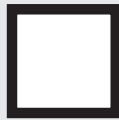

**CONFIGURATION**  
 028 - 4 Rows/7 Columns  
 052 - 4 Rows/13 Columns  
 076 - 4 Rows/19 Columns  
 100 - 4 Rows/25 Columns  
 128 - 4 Rows/32 Columns  
 152 - 4 Rows/38 Columns  
 200 - 4 Rows/50 Columns  
 252 - 4 Rows/63 Columns  
 300 - 4 Rows/75 Columns



**PLATING**  
 1 - 50 μ" Au  
 3 - 30 μ" Au  
 7 - 50 μ" Au / 20 μ" Au  
 9 - 30 μ" Au / 20 μ" Au



**TYPE**  
 00 - None



**VARIATION**  
 Blank - None  
 XXX - Consult factory

**CONTACT**  
 30 - 0.270" Long  
 31 - 0.300" Long  
 32 - 0.400" Long  
 33 - 0.500" Long  
 34 - 0.700" Long  
 35 - 0.800" Long  
 36 - 0.900" Long  
 37 - 0.600" Long  
 38 - 1.000" Long

**HARDWARE**  
 39 - 0.370" Long (use with #30 contact)  
 40 - 0.400" Long (use with #31 contact)  
 41 - 0.500" Long (use with #32 contact)  
 42 - 0.600" Long (use with #33 contact)  
 43 - 0.800" Long (use with #34 contact)  
 44 - 0.900" Long (use with #35 contact)  
 45 - 1.000" Long (use with #36 contact)  
 46 - 0.700" Long (use with #37 contact)  
 47 - 1.100" Long (use with #38 contact)



PLEASE CONSULT THE AIRBORN WEBSITE FOR THE LATEST REVISION OF THIS DOCUMENT PRIOR TO BEGINNING ANY DESIGN WORK.

### MATED HEIGHT

The connector body height is 0.150" but the functional spacing (the bottom surface of the board, on which the connector is mounted, to the top of the connector below it) can be modified based on the contact/pin length selected (see Table 2 in top window).

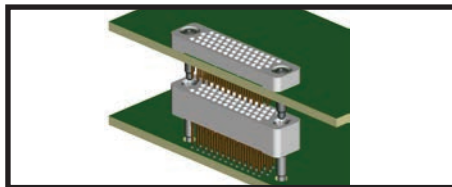

### MATERIALS and FINISHES

Contact: ..... BeCu per ASTM B768 (BeCu C17410 brush alloy 174)  
 Contact Finish: ..... Gold per MIL-G-45204 over nickel per IAW QQ-N-290  
 Molded Insulator: ..... Glass-filled polyphenylene sulfide (PPS) per MIL-M-24519  
 Hardware: ..... Stainless steel per ASTM A582, passivated per ASTM 967  
 Guide Pin/Socket: ..... BeCu per ASTM B196/197, nickel-plated per QQ-N-290

NOTE: AirBorn can manufacture special configurations to your exact specifications.

### PERFORMANCE

Contact Rating: ..... 3 amperes  
 Operating Temperature: ..... -65° C to +125° C  
 Insulation Resistance: ..... 5,000 megaohms minimum @ 500 VDC  
 Durability: ..... 500 connector mating cycles  
 Contact Resistance: ..... 3 to 5 milliohms (contact length dependent)  
 Contact Engagement Force: ..... 4.0 oz (113 g) max. w/0.0246" dia. test pin  
 Contact Separation Force: ..... 0.5 oz (14 g) min. w/0.0226" dia. test pin  
 Compliant Insertion Force: ..... 22.5 lb (10.21 Kg) max. per contact  
 Compliant Removal Force: ..... 4.5 lb (2.04 Kg) min. per contact

### SI DATA - Differential 100 Ohm

1	Diff. Insertion Loss	5.0 GHz @ -3 dB
2	Diff. Return Loss	2.0 GHz @ -8 dB
3	NEXT	4.0 GHz @ -25 dB
4	FEXT	4.0 GHz @ -35 dB



## RC4B2 - Bottom-of-Stack Cable Mating Connector (Female)

Contact spacing: 0.075" (1.91 mm)

A full profile bodied female cable connector for use at the bottom of an RC board stack application.

### DIMENSIONS

TABLE 1			
SIZE	A	B	C
28	1.014	0.784	0.450
52	1.464	1.234	0.900
76	1.914	1.684	1.350
100	2.364	2.134	1.800
128	2.889	2.659	2.325
152	3.339	3.109	2.775

Tolerances: ± 0.010"

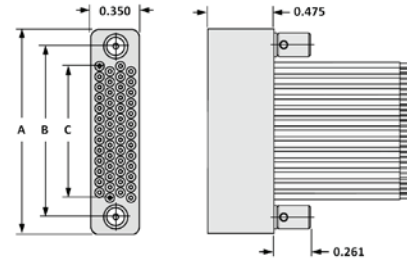

### Sample Part Number Format: RC4B2-052-281-62ED



**SERIES**  
 Stackable  
 Compliant  
 Full-Profile  
 4 Rows  
 0.075" Spacing  
 Bottom-of-Stack  
 Cable Female



**CONFIGURATION**  
 028 – 4 Rows/7 Columns  
 052 – 4 Rows/13 Columns  
 076 – 4 Rows/19 Columns  
 100 – 4 Rows/25 Columns  
 128 – 4 Rows/32 Columns  
 152 – 4 Rows/38 Columns



**CONTACT**  
 28 – Socket, crimp, 26-24 AWG  
 29 – Socket, crimp, 30-28 AWG



**PLATING**  
 1 – 50 μ" Au  
 3 – 30 μ" Au



**HARDWARE**  
 00 – None  
 58 – Guide socket, non-polarized  
 62 – Jacksocket, hex, turning



**TYPE**  
 00 – None  
 XX – See Wire Codes



**VARIATION**  
 Blank – None  
 XXX – Consult factory

#### WIRE CODES

TYPE and COLOR			LENGTH	
Code	Size	Color	Code	Length (+1"/-0")
Mil-W-16878/4				
C	24 awg	Ten repeating	A	6"
D	24 awg	White	B	12"
E	26 awg	Ten repeating	C	18"
F	26 awg	White	D	24"
G	28 awg	Ten repeating	E	30"
H	28 awg	White	F	36"
J	30 awg	Ten repeating	G	42"
K	30 awg	White	H	48"
Mil-W-22759/33				
N	24 awg	Ten repeating	J	54"
P	24 awg	White	K	60"
R	26 awg	Ten repeating	L	66"
S	26 awg	White	M	72"
T	28 awg	Ten repeating	N	84"
U	28 awg	White	P	96"
V	30 awg	Ten repeating	R	108"
W	30 awg	White	S	120"

PLEASE CONSULT THE AIRBORNE WEBSITE FOR THE LATEST REVISION OF THIS DOCUMENT PRIOR TO BEGINNING ANY DESIGN WORK.

### MATED HEIGHT

Connector body height is 0.475" and is designed to mount flush to the board bottom of the mating connector.

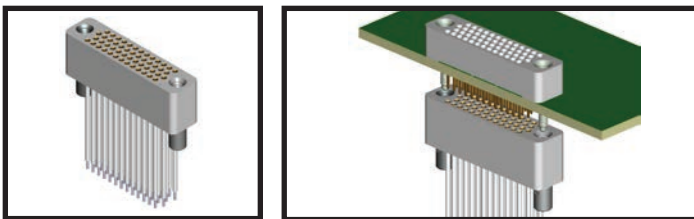

### NOTES

- The RC4B2 connector is designed to mate with an RC422 connector using contact option -21 (0.270" long) and -39MT hardware. This contact length and hardware combination assures proper connector mating when using boards having a thickness of 0.058"–0.125".
- When guide hardware is required on the RC4B2 connector, use hardware option -3900 on the mating connector.
- When jacksocket hardware is required on the RC4B2 connector, use hardware option -39MT on the mating connector.

### MATERIALS and FINISHES

Contact: ..... BeCu per ASTM B196 or B197 (BeCu alloy 172 or 173)  
 Contact Finish: ..... Gold per MIL-G-45204 over nickel per QQ-N-290  
 Molded Insulator: ..... Glass-filled polyphenylene sulfide (PPS) per MIL-M-24519  
 Hardware: ..... Stainless steel per ASTM A484/A484M and ASTM A582/A582M, passivated per SAE AMS-2700

NOTE: AirBorn can manufacture special configurations to your exact specifications.

### PERFORMANCE

Contact Rating: ..... 3 amperes  
 Operating Temperature: ..... -65° C to +125° C  
 Insulation Resistance: ..... 5,000 megaohms minimum @ 500 VDC  
 Durability: ..... 500 connector mating cycles  
 Contact Resistance: ..... 3 to 5 milliohms (contact length dependent)  
 Contact Engagement Force: ..... 4.0 oz (113 g) max. w/0.0248" dia. test pin  
 Contact Separation Force: ..... 0.5 oz (14 g) min. w/0.0226" dia. test pin



## RC4C2 - Top-of-Stack Cable Mating Connector (Male)

Contact spacing: 0.075" (1.91 mm)

A full profile bodied male pre-wired cable connector for use at the top of an RC board stack application.

### DIMENSIONS

SIZE	A	B	C
28	1.014	0.784	0.450
52	1.464	1.234	0.900
76	1.914	1.684	1.350
100	2.364	2.134	1.800
128	2.889	2.659	2.325
152	3.339	3.109	2.775

Tolerances: ± 0.010"

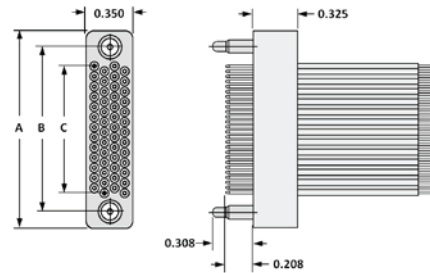

### Sample Part Number Format: RC4C2-052-181-57ED



**SERIES**  
 Stackable  
 Compliant  
 Full-Profile  
 4 Rows  
 0.075" Spacing  
 Top-of-Stack  
 Cable Mate



**CONFIGURATION**  
 028 – 4 Rows/7 Columns  
 052 – 4 Rows/13 Columns  
 076 – 4 Rows/19 Columns  
 100 – 4 Rows/25 Columns  
 128 – 4 Rows/32 Columns  
 152 – 4 Rows/38 Columns



**PLATING**  
 1 – 50 μ" Au  
 3 – 30 μ" Au

**CONTACT**  
 18 – Pin, crimp, 26-24 AWG  
 19 – Pin, crimp, 30-28 AWG



**HARDWARE**  
 00 – None  
 57 – Guide pin, non-polarized  
 61 – Jackscrew, hex, turning\*



**TYPE**  
 XX – See Wire Codes

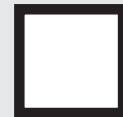

**VARIATION**  
 Blank – None  
 XXX – Consult factory

#### WIRE CODES

TYPE and COLOR			LENGTH	
Code	Size	Color	Code	Length (+1"/-0")
<b>Mil-W-16878/4</b>				
C	24 awg	Ten repeating	A	6"
D	24 awg	White	B	12"
E	26 awg	Ten repeating	C	18"
F	26 awg	White	D	24"
G	28 awg	Ten repeating	E	30"
H	28 awg	White	F	36"
J	30 awg	Ten repeating	G	42"
K	30 awg	White	H	48"
<b>Mil-W-22759/33</b>				
N	24 awg	Ten repeating	J	54"
P	24 awg	White	K	60"
R	26 awg	Ten repeating	L	66"
S	26 awg	White	M	72"
T	28 awg	Ten repeating	N	84"
U	28 awg	White	P	96"
V	30 awg	Ten repeating	R	108"
W	30 awg	White	S	120"

PLEASE CONSULT THE AIRBORN WEBSITE FOR THE LATEST REVISION OF THIS DOCUMENT PRIOR TO BEGINNING ANY DESIGN WORK.

### MATED HEIGHT

Connector body height is 0.325" and is designed to mount flush to the mating connector.

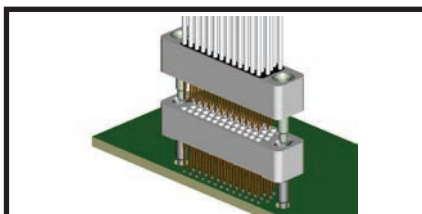
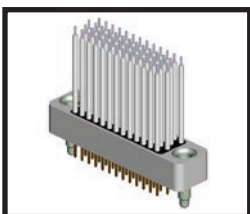

### NOTES

\* To use the -61 jackscrew hardware option, the fixed jacknut hardware (-XXMT) must be in place on the mating board connector.

### MATERIALS and FINISHES

Contact: ..... BeCu per ASTM B196 or B197 (BeCu alloy 172 or 173)  
 Contact Finish: ..... Gold per MIL-G-45204 over nickel per QQ-N-290  
 Molded Insulator: ..... Glass-filled polyphenylene sulfide (PPS) per MIL-M-24519  
 Hardware: ..... Stainless steel per ASTM A484/A484M and ASTM A582/A582M, passivated per SAE AMS-2700

NOTE: AirBorn can manufacture special configurations to your exact specifications.

### PERFORMANCE

Contact Rating: ..... 3 amperes  
 Operating Temperature: ..... -65° C to +125° C  
 Insulation Resistance: ..... 5,000 megaohms minimum @ 500 VDC  
 Durability: ..... 500 connector mating cycles  
 Contact Resistance: ..... 3 to 5 milliohms (contact length dependent)  
 Contact Engagement Force: ..... 4.0 oz (113 g) max. w/0.0248" dia. test pin  
 Contact Separation Force: ..... 0.5 oz (14 g) min. w/0.0226" dia. test pin



## RC4C2 - Top-of-Stack Flex Circuit Mating Connector (Male)

Contact spacing: 0.075" (1.91 mm)

A full profile bodied flex-circuit-ready male connector for use at the top of an RC board stack application.

### DIMENSIONS

TABLE 1			
SIZE	A	B	C
28	1.014	0.784	0.450
52	1.464	1.234	0.900
76	1.914	1.684	1.350
100	2.364	2.134	1.800
128	2.889	2.659	2.325
152	3.339	3.109	2.775

Tolerances: ± 0.010"

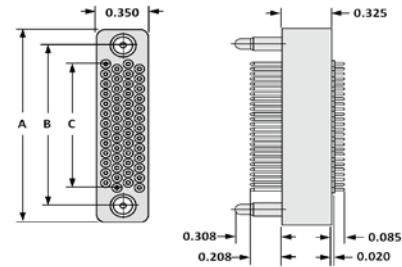

### Sample Part Number Format: RC4C2-052-151-5700



**SERIES**  
 Stackable  
 Compliant  
 Full-Profile  
 4 Rows  
 0.075" Spacing  
 Top-of-Stack  
 Cable Mate

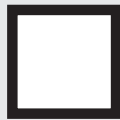

**CONFIGURATION**  
 028 – 4 Rows/7 Columns  
 052 – 4 Rows/13 Columns  
 076 – 4 Rows/19 Columns  
 100 – 4 Rows/25 Columns  
 128 – 4 Rows/32 Columns  
 152 – 4 Rows/38 Columns



**CONTACT**  
 15 – Pin, flex circuit



**PLATING**  
 1 – 50 μ" Au  
 3 – 30 μ" Au

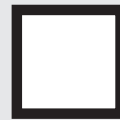

**HARDWARE**  
 00 – None  
 57 – Guide pin, non-polarized  
 61 – Jackscrew, hex, turning\*



**TYPE**  
 00 – None



**VARIATION**  
 Blank – None  
 XXX – Consult factory



PLEASE CONSULT THE AIRBORN WEBSITE FOR THE LATEST REVISION OF THIS DOCUMENT PRIOR TO BEGINNING ANY DESIGN WORK.

### MATED HEIGHT

Connector body height is 0.325" and is designed to mount flush to the mating connector.

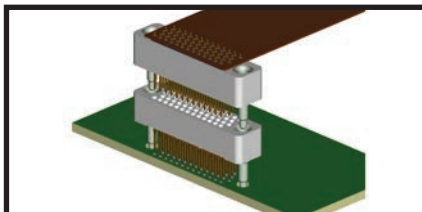
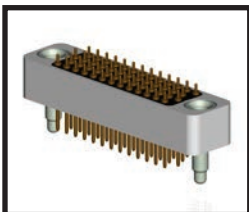

### MATERIALS and FINISHES

Contact: ..... BeCu per ASTM B196 or B197 (BeCu alloy 172 or 173)  
 Contact Finish: ..... Gold per MIL-G-45204 over nickel per QQ-N-290  
 Molded Insulator: ..... Glass-filled polyphenylene sulfide (PPS) per MIL-M-24519  
 Hardware: ..... Stainless steel per ASTM A484/A484M and ASTM A582/A582M,  
 passivated per SAE AMS-2700

NOTE: AirBorn can manufacture special configurations to your exact specifications.

### PERFORMANCE

Contact Rating: ..... 3 amperes  
 Operating Temperature: ..... -65° C to +125° C  
 Insulation Resistance: ..... 5,000 megaohms minimum @ 500 VDC  
 Durability: ..... 500 connector mating cycles  
 Contact Resistance: ..... 3 to 5 milliohms (contact length dependent)  
 Contact Engagement Force: ..... 4.0 oz (113 g) max. w/0.0246" dia. test pin  
 Contact Separation Force: ..... 0.5 oz (14 g) min. w/0.0226" dia. test pin

### NOTES

\* To use the -61 jackscrew hardware option, the fixed jacknut hardware (-XXMT) must be in place on the mating board connector.



## RC4C2 - Top-of-Stack Solder Cup Cable Mating Connector (Male)

Contact spacing: 0.075" (1.91 mm)

A full profile bodied male wire-ready connector for use at the top of an RC board stack application.

### DIMENSIONS

TABLE 1			
SIZE	A	B	C
28	1.014	0.784	0.450
52	1.464	1.234	0.900
76	1.914	1.684	1.350
100	2.364	2.134	1.800
128	2.889	2.659	2.325
152	3.339	3.109	2.775

Tolerances: ± 0.010"

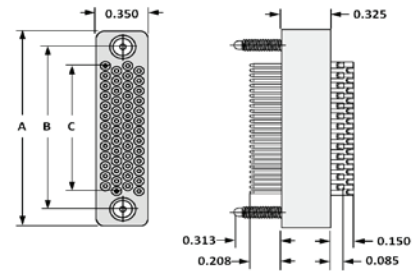

### Sample Part Number Format: RC4C2-052-111-6100



#### SERIES

Stackable  
 Compliant  
 Full-Profile  
 4 Rows  
 0.075" Spacing  
 Top-of-Stack  
 Cable Mate

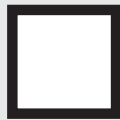

#### CONFIGURATION

028 – 4 Rows/7 Columns  
 052 – 4 Rows/13 Columns  
 076 – 4 Rows/19 Columns  
 100 – 4 Rows/25 Columns  
 128 – 4 Rows/32 Columns  
 152 – 4 Rows/38 Columns



#### CONTACT

11 – Pin, solder cup



#### PLATING

1 – 50 μ" Au  
 3 – 30 μ" Au

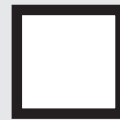

#### HARDWARE

00 – None  
 57 – Guide pin, non-polarized  
 61 – Jackscrew, hex, turning\*



#### TYPE

00 – None



#### VARIATION

Blank – None  
 XXX – Consult factory



PLEASE CONSULT THE AIRBORN WEBSITE FOR THE LATEST REVISION OF THIS DOCUMENT PRIOR TO BEGINNING ANY DESIGN WORK.

### MATED HEIGHT

Connector body height is 0.325" and is designed to mount flush to the mating connector.

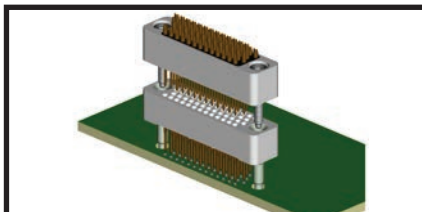

### MATERIALS and FINISHES

Contact: ..... BeCu per ASTM B196 or B197 (BeCu alloy 172 or 173)  
 Contact Finish: ..... Gold per MIL-G-45204 over nickel per QQ-N-290  
 Molded Insulator: ..... Glass-filled polyphenylene sulfide (PPS) per MIL-M-24519  
 Hardware: ..... Stainless steel per ASTM A484/A484M and ASTM A582/A582M, passivated per SAE AMS-2700

NOTE: AirBorn can manufacture special configurations to your exact specifications.

### PERFORMANCE

Contact Rating: ..... 3 amperes  
 Operating Temperature: ..... -65° C to +125° C  
 Insulation Resistance: ..... 5,000 megaohms minimum @ 500 VDC  
 Durability: ..... 500 connector mating cycles  
 Contact Resistance: ..... 3 to 5 milliohms (contact length dependent)  
 Contact Engagement Force: ..... 4.0 oz (113 g) max. w/0.0246" dia. test pin  
 Contact Separation Force: ..... 0.5 oz (14 g) min. w/0.0226" dia. test pin

### NOTES

\* To use the -61 jackscrew hardware option, the fixed jacknut hardware (-XXMT) must be in place on the mating board connector.





## RC 4-ROW DIMENSIONS

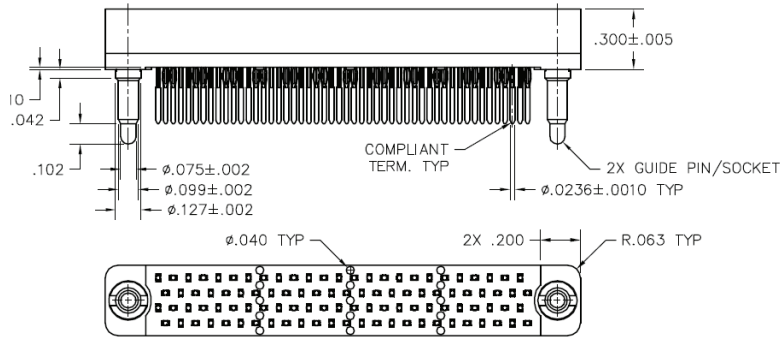
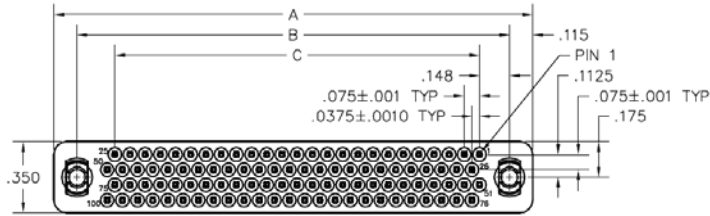

BODY STYLE  
422

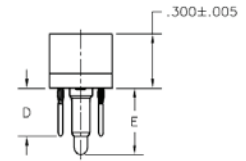

BODY STYLE  
422

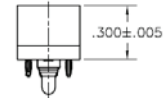

CONTACT/HARDWARE  
OPTION 101  
(TERMINATES CIRCUIT)

BODY STYLE  
442

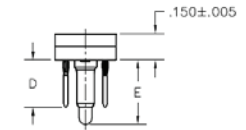

OPTIONAL INSULATOR FOR TOP CONNECTOR  
WITH TERMINATION OPTIONS: 301, 311, 321,  
331, 341, 351, 361, 371 AND 381  
(w/CIRCUIT TEST POINT).

DIMENSIONS			
SIZE	A	B	C
28	1.014	0.784	0.450
52	1.464	1.234	0.900
76	1.914	1.684	1.350
100	2.364	2.134	1.800
128	2.889	2.659	2.325
152	3.339	3.109	2.775
200	4.239	4.009	3.675
252	5.214	4.984	4.650
300	6.114	5.884	5.500

TABLE 1		
CONTACT TERMINATION	CONTACT D	HARDWARE E
201, 301	0.270	0.370
211, 311	0.300	0.400
221, 321	0.400	0.500
231, 331	0.500	0.600
241, 341	0.700	0.800
251, 351	0.800	0.900
261, 361	0.900	1.000
271, 371	0.600	0.700
281, 381	1.000	1.100
101	0.095	0.195

### PWB-PLATED THRU-HOLE RECOMMENDATIONS:

Board material: FR-4 (or equivalent) with 1.0 oz. copper

Board thickness: 0.058" minimum

Drilled hole:  $\phi 0.033$ "

Copper plating thickness: 0.0020"

Tin-lead plating thickness: 0.0005"

Finished hold diameter:  $\phi 0.028$ " ( $\phi 0.028$ "  $\pm 0.002$ " required)



## RC 4-ROW DRAWINGS

### Board Footprint and Dimensions

SIZE	CONTACT ID	SIZE	CONTACT ID
28		152	
52		200	
76		252	
100		300	
128			

DIMENSIONS			
SIZE	A	B	C
28	1.014	0.784	0.450
52	1.464	1.234	0.900
76	1.914	1.684	1.350
100	2.364	2.134	1.800
128	2.889	2.659	2.325
152	3.339	3.109	2.775
200	4.239	4.009	3.675
252	5.214	4.984	4.650
300	6.114	5.884	5.500

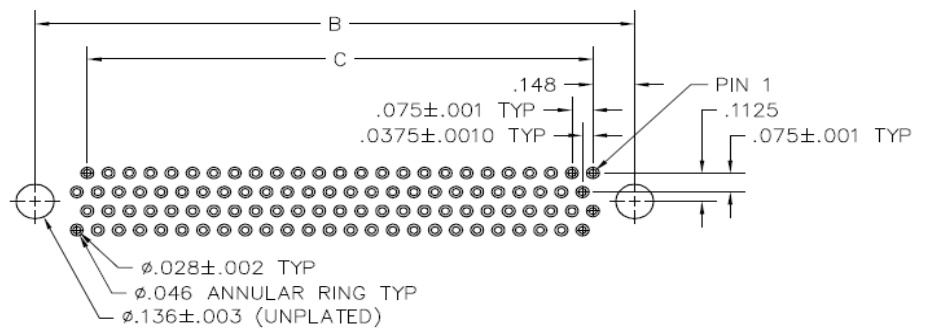

### PWB-PLATED THRU-HOLE RECOMMENDATIONS:

Board material: FR-4 (or equivalent) with 1.0 oz. copper  
 Board thickness: 0.058" minimum  
 Drilled hole: Ø 0.033"

Copper plating thickness: 0.0020"  
 Tin-lead plating thickness: 0.0005"  
 Finished hold diameter: Ø 0.028" (Ø 0.028" ±0.002" required)



## RC 4-ROW DIMENSIONS

### Plating Options

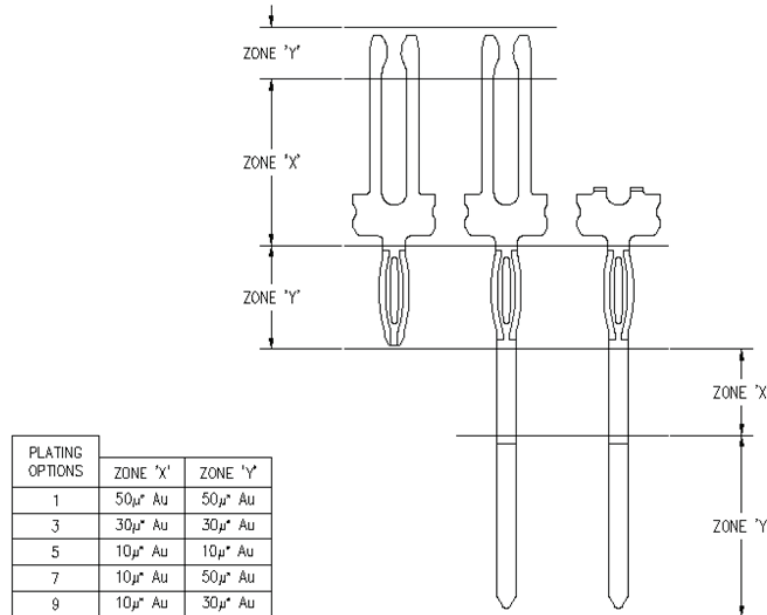

### Determining the Required Termination Lead Length

To calculate the required termination lead length, use the example below. Measurements listed are in inches.

Dimension A = 0.720  
 $0.720 - 0.300$  (insulator height) = 0.420  
 $0.420 + 0.114$  (minimum pin engagement) = 0.534  
 $0.420 + 0.214$  (maximum pin engagement) = 0.634

In this example, the termination option to choose is 0.600 lead length.

The contact termination option will be a length that falls between the calculated numbers resulting from using the minimum and maximum pin engagement.

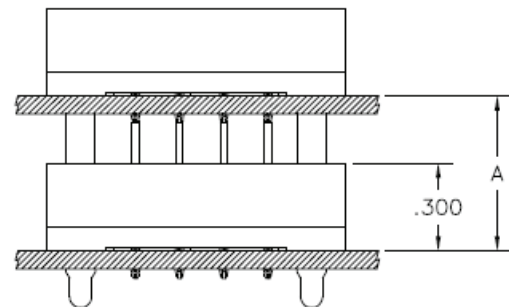

### PWB-PLATED THRU-HOLE RECOMMENDATIONS:

Board material: FR-4 (or equivalent) with 1.0 oz. copper  
 Board thickness: 0.058" minimum  
 Drilled hole:  $\varnothing$  0.033"

Copper plating thickness: 0.0020"  
 Tin-lead plating thickness: 0.0005"  
 Finished hold diameter:  $\varnothing$  0.028" ( $\varnothing$  0.028"  $\pm$  0.002" required)



## RC 4-ROW DRAWINGS

### Stacking Detail

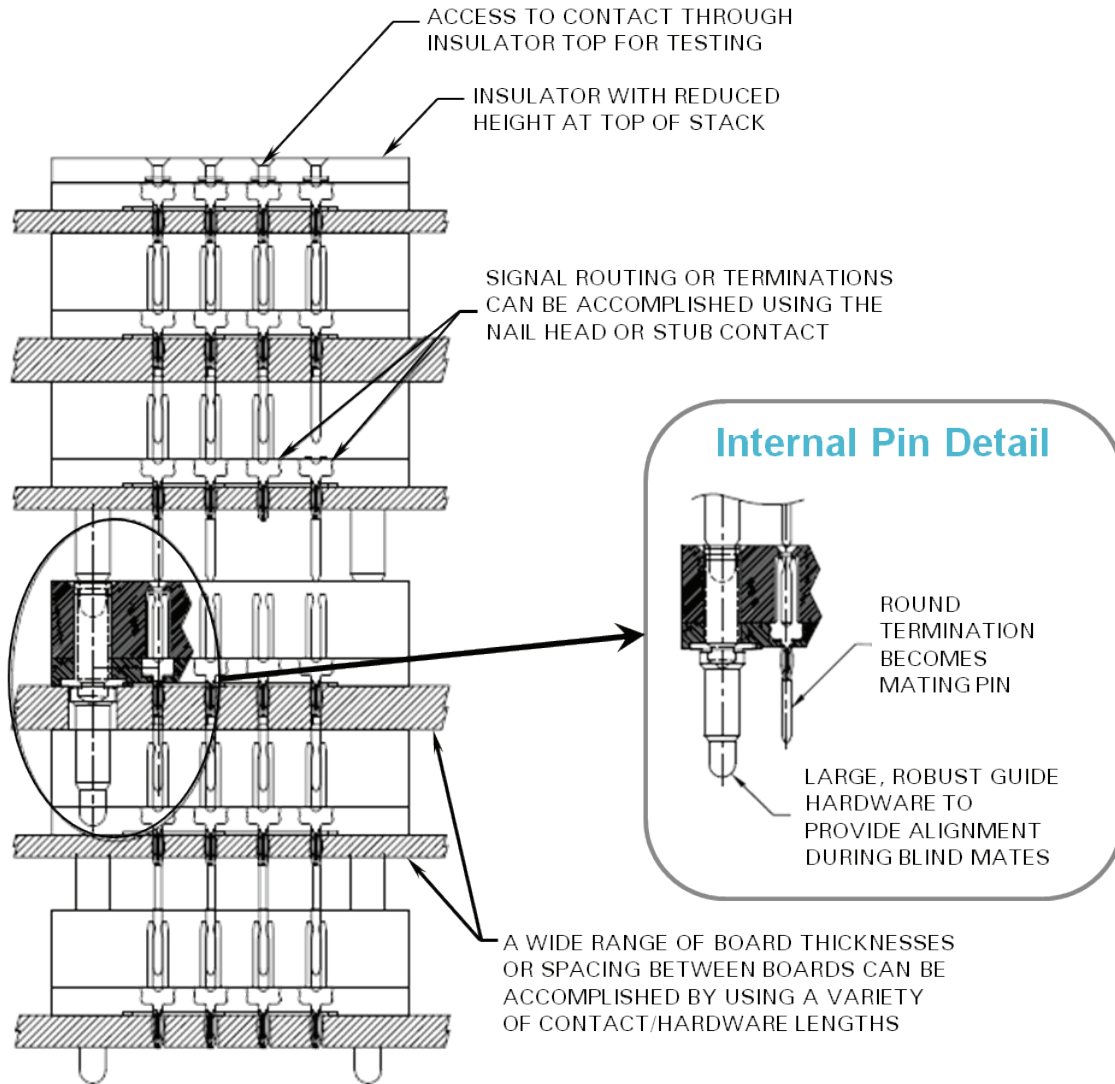

### PWB-PLATED THRU-HOLE RECOMMENDATIONS:

Board material: FR-4 (or equivalent) with 1.0 oz. copper

Board thickness: 0.058" minimum

Drilled hole:  $\varnothing$  0.033"

Copper plating thickness: 0.0020"

Tin-lead plating thickness: 0.0005"

Finished hold diameter:  $\varnothing$  0.028" ( $\varnothing$  0.028"  $\pm$ 0.002" required)



## RC 4-ROW, BOTTOM-COMPLIANT DIMENSIONS

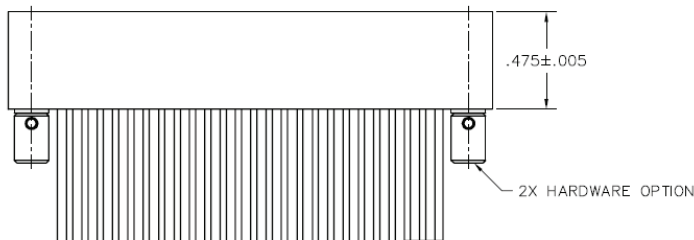
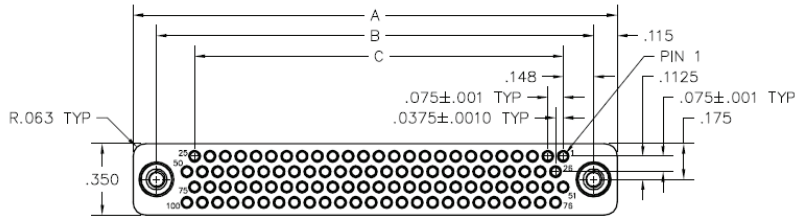

DIMENSIONS			
SIZE	A	B	C
28	1.014	0.784	0.450
52	1.464	1.234	0.900
76	1.914	1.684	1.350
100	2.364	2.134	1.800
128	2.889	2.659	2.325
152	3.339	3.109	2.775
200	4.239	4.009	3.675

GUIDE SOCKET



HARDWARE STYLE 58

#2-56 JACKSOCKET



HARDWARE STYLE 62

### PWB-PLATED THRU-HOLE RECOMMENDATIONS:

Board material: FR-4 (or equivalent) with 1.0 oz. copper

Board thickness: 0.058" minimum

Drilled hole:  $\varnothing$  0.033"

Copper plating thickness: 0.0020"

Tin-lead plating thickness: 0.0005"

Finished hold diameter:  $\varnothing$  0.028" ( $\varnothing$  0.028"  $\pm$ 0.002" required)



## RC 4-ROW, BOTTOM-COMPLIANT DRAWINGS

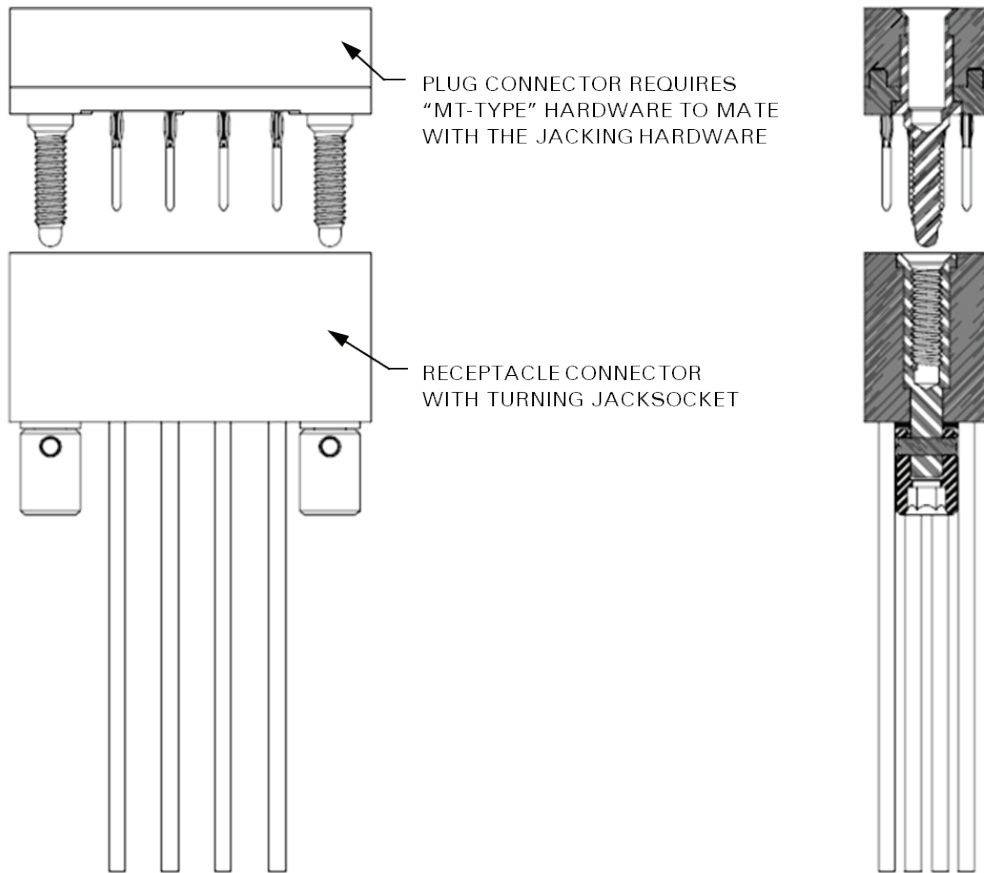

### PWB-PLATED THRU-HOLE RECOMMENDATIONS:

Board material: FR-4 (or equivalent) with 1.0 oz. copper

Board thickness: 0.058" minimum

Drilled hole:  $\varnothing$  0.033"

Copper plating thickness: 0.0020"

Tin-lead plating thickness: 0.0005"

Finished hold diameter:  $\varnothing$  0.028" ( $\varnothing$  0.028"  $\pm$  0.002" required)



## RC 4-ROW, TOP-COMPLIANT DIMENSIONS

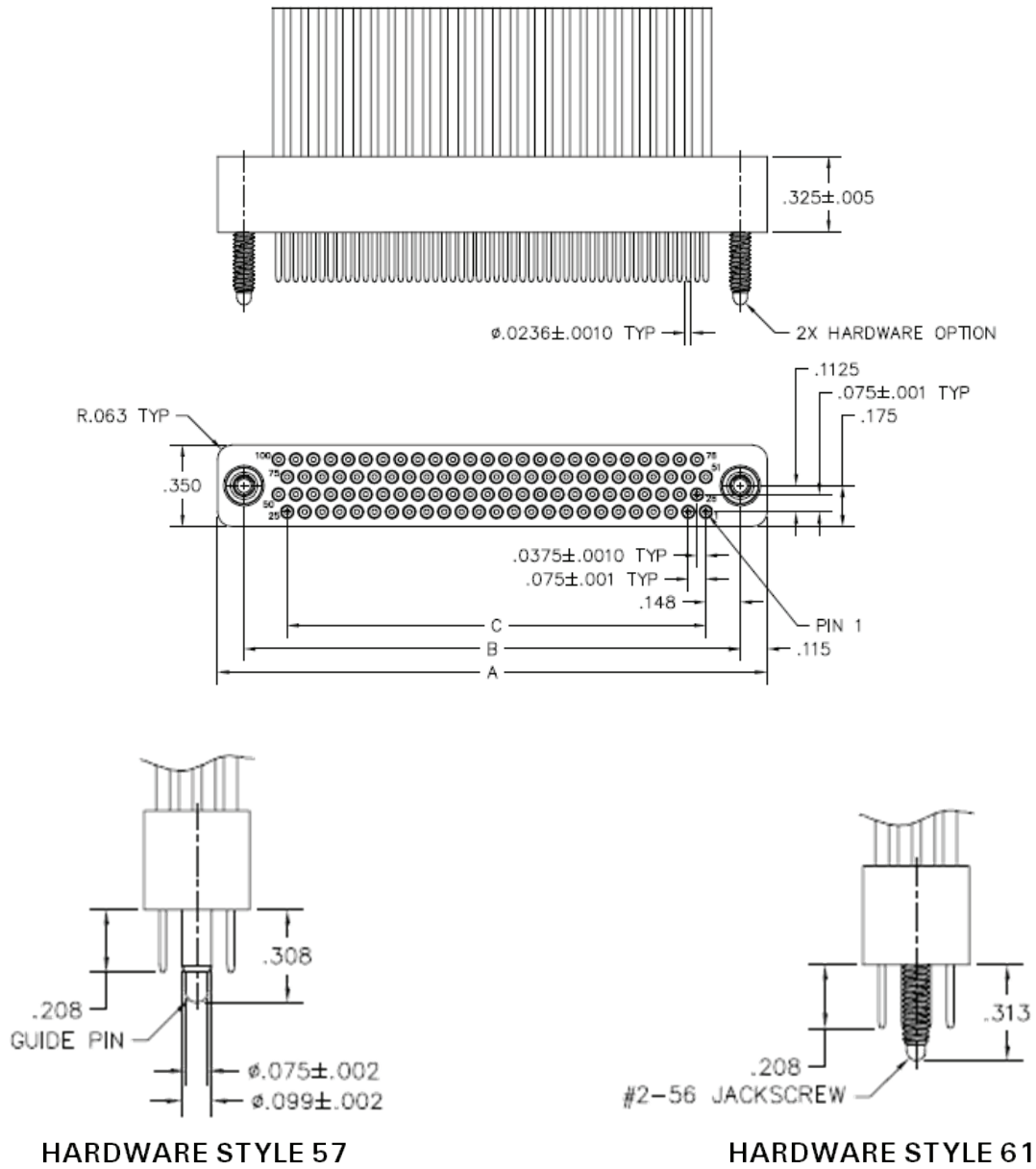

### PWB-PLATED THRU-HOLE RECOMMENDATIONS:

Board material: FR-4 (or equivalent) with 1.0 oz. copper

Board thickness: 0.058" minimum

Drilled hole:  $\phi 0.033$ "

Copper plating thickness: 0.0020"

Tin-lead plating thickness: 0.0005"

Finished hold diameter:  $\phi 0.028$ " ( $\phi 0.028$ "  $\pm 0.002$ " required)



## RC 4-ROW, TOP-COMPLIANT DRAWINGS

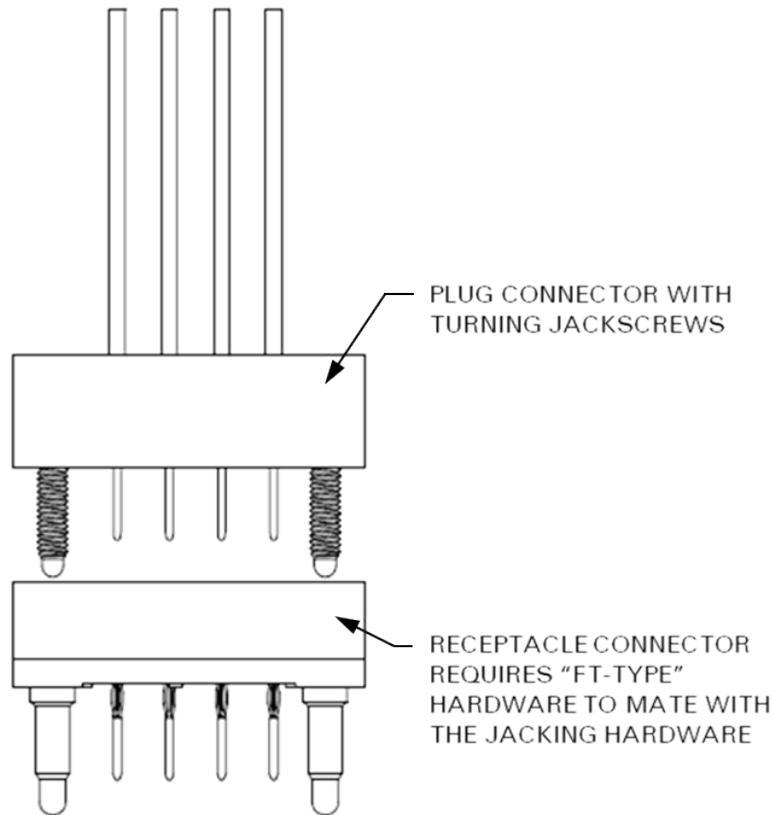

### PWB-PLATED THRU-HOLE RECOMMENDATIONS:

Board material: FR-4 (or equivalent) with 1.0 oz. copper

Board thickness: 0.058" minimum

Drilled hole:  $\varnothing$  0.033"

Copper plating thickness: 0.0020"

Tin-lead plating thickness: 0.0005"

Finished hold diameter:  $\varnothing$  0.028" ( $\varnothing$  0.028"  $\pm$  0.002" required)



# Mouser Electronics

Authorized Distributor

Click to View Pricing, Inventory, Delivery & Lifecycle Information:

[AirBorn:](#)

[RC422-076-371-4600](#)