

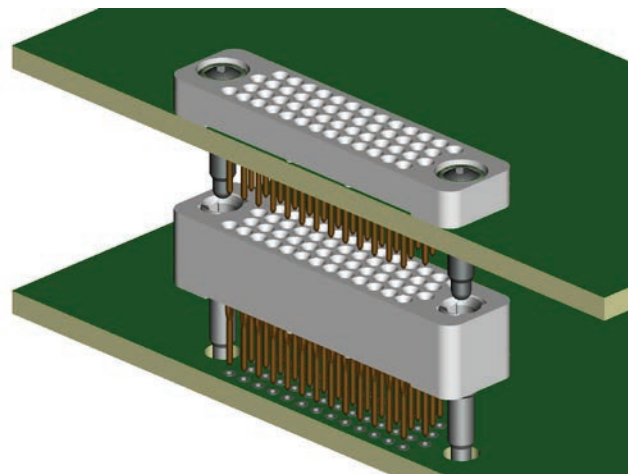

IRRC™

The AirBorn stackable compliant connector family is one of AirBorn's solutions for high-density, board-to-board stacking applications. This connector family is available in 0.075" contact spacing and 100 Ω and 85 Ω differential serial buses.

- Wide variety of standard pin/tail lengths accommodate any board-to-board spacing
- 0.075" contact spacing
- Reliable "eye of the needle"-compliant section design eliminates soldering
- BeCu contacts (special high-conductivity, high-temperature alloy)
- Very robust socket contact (low-stress design)
- Individually repairable contacts





RC422 - Full Profile Board-to-Board Stackable Connector

Contact spacing: 0.075" (1.91 mm)

A full bodied high-density press-fit connector. Uses a patented female/compliant/male stacking contact system. Used in board-to-board stacking applications.

DIMENSIONS

| SIZE | A | B | C |
|------|-------|-------|-------|
| 28 | 1.014 | 0.784 | 0.450 |
| 52 | 1.464 | 1.234 | 0.900 |
| 76 | 1.914 | 1.684 | 1.350 |
| 100 | 2.364 | 2.134 | 1.800 |
| 128 | 2.889 | 2.659 | 2.325 |
| 152 | 3.339 | 3.109 | 2.775 |
| 200 | 4.239 | 4.009 | 3.675 |
| 252 | 5.214 | 4.984 | 4.650 |
| 300 | 6.114 | 5.884 | 5.550 |

Tolerances: ± 0.010"

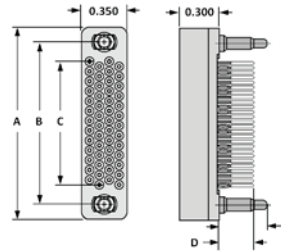

| CONTACT SELECTION | CONTACT D | HARDWARE E |
|-------------------|-----------|------------|
| 10 | 0.095 | 0.195 |
| 20 | 0.270 | 0.370 |
| 21 | 0.300 | 0.400 |
| 22 | 0.400 | 0.500 |
| 23 | 0.500 | 0.600 |
| 24 | 0.700 | 0.800 |
| 25 | 0.800 | 0.900 |
| 26 | 0.900 | 1.000 |
| 27 | 0.600 | 0.700 |
| 28 | 1.000 | 1.100 |

Sample Part Number Format: RC422-052-211-4000



SERIES
 Stackable
 Compliant
 Full-Profile
 4 Rows
 0.075" Spacing



CONFIGURATION
 028 – 4 Rows/7 Columns
 052 – 4 Rows/13 Columns
 076 – 4 Rows/19 Columns
 100 – 4 Rows/25 Columns
 128 – 4 Rows/32 Columns
 152 – 4 Rows/38 Columns
 200 – 4 Rows/50 Columns
 252 – 4 Rows/63 Columns
 300 – 4 Rows/75 Columns



PLATING
 1 – 50 μ" Au
 3 – 30 μ" Au
 7 – 50 μ" Au / 20 μ" Au
 9 – 30 μ" Au / 20 μ" Au



TYPE
 00 – None
 FT – Female thread
 MT – Male thread
 (#39 hardware, only)



VARIATION
 Blank – None
 XXX – Consult factory

CONTACT
 10 – 0.095" Long
 20 – 0.270" Long
 21 – 0.300" Long
 22 – 0.400" Long
 23 – 0.500" Long
 24 – 0.700" Long
 25 – 0.800" Long
 26 – 0.900" Long
 27 – 0.600" Long
 28 – 1.000" Long
 30 – 0.270" Long
 31 – 0.300" Long
 32 – 0.400" Long
 33 – 0.500" Long
 34 – 0.700" Long
 35 – 0.800" Long
 36 – 0.900" Long
 37 – 0.600" Long
 38 – 1.000" Long

HARDWARE
 30 – 0.195" Long (use with #10 contact)
 39 – 0.370" Long (use with #20 contact)
 40 – 0.400" Long (use with #21 contact)
 41 – 0.500" Long (use with #22 contact)
 42 – 0.600" Long (use with #23 contact)
 43 – 0.800" Long (use with #24 contact)
 44 – 0.900" Long (use with #25 contact)
 45 – 1.000" Long (use with #26 contact)
 46 – 0.700" Long (use with #27 contact)
 47 – 1.100" Long (use with #28 contact)



PLEASE CONSULT THE AIRBORN WEBSITE FOR THE LATEST REVISION OF THIS DOCUMENT PRIOR TO BEGINNING ANY DESIGN WORK.

MATED HEIGHT

The connector body height is 0.300" and, when used with the -20 or -30 (0.270") contact, the mounting is flush (board-bottom-mounted to connector top). This board-bottom to connector-top spacing can be modified based on the contact selected by approximately the difference in pin length (see Table 2 in top window).

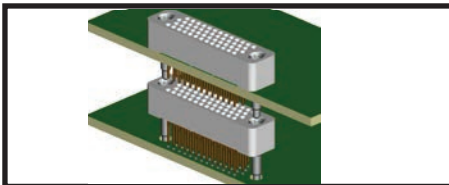
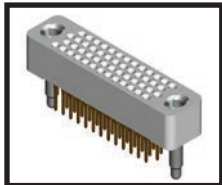

MATERIALS and FINISHES

Contact: BeCu per ASTM B768 (BeCu C17410 brush alloy 174)
 Contact Finish: Gold per MIL-G-45204 over nickel per IAW QQ-N-290
 Molded Insulator: Glass-filled polyphenylene sulfide (PPS) per MIL-M-24519
 Hardware: Stainless steel per ASTM A582, passivated per ASTM 967
 Guide Pin/Socket: BeCu per ASTM B196/197, nickel-plated per QQ-N-290

NOTE: AirBorn can manufacture special configurations to your exact specifications.

PERFORMANCE

Contact Rating: 3 amperes
 Operating Temperature: -65° C to +125° C
 Insulation Resistance: 5,000 megaohms minimum @ 500 VDC
 Durability: 500 connector mating cycles
 Contact Resistance: 3 to 5 milliohms (contact length-dependent)
 Contact Engagement Force: 4.0 oz (113 g) max. w/0.0246" dia. test pin
 Contact Separation Force: 0.5 oz (14 g) min. w/0.0226" dia. test pin
 Compliant Insertion Force: 22.5 lb (10.21 Kg) max. per contact
 Compliant Removal Force: 4.5 lb (2.04 Kg) min. per contact

SI DATA – Differential 100 Ohm

| | | |
|---|----------------------|------------------|
| 1 | Diff. Insertion Loss | 5.0 GHz @ -3 dB |
| 2 | Diff. Return Loss | 2.0 GHz @ -8 dB |
| 3 | NEXT | 4.0 GHz @ -25 dB |
| 4 | FEXT | 4.0 GHz @ -35 dB |



RC422 - Bottom-of-Stack Board Mount Connector

Contact spacing: 0.075" (1.91 mm)

A full bodied high-density press-fit connector. Uses a patented female/compliant/male stacking contact system. Used at the bottom of the stack in board-to-board stacking applications.

DIMENSIONS

| SIZE | A | B | C |
|------|-------|-------|-------|
| 28 | 1.014 | 0.784 | 0.450 |
| 52 | 1.464 | 1.234 | 0.900 |
| 76 | 1.914 | 1.684 | 1.350 |
| 100 | 2.364 | 2.134 | 1.800 |
| 128 | 2.889 | 2.659 | 2.325 |
| 152 | 3.339 | 3.109 | 2.775 |
| 200 | 4.239 | 4.009 | 3.675 |
| 252 | 5.214 | 4.984 | 4.650 |
| 300 | 6.114 | 5.884 | 5.550 |

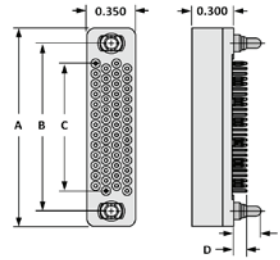

| CONTACT SELECTION | CONTACT D | HARDWARE E |
|-------------------|-----------|------------|
| 10 | 0.095 | 0.195 |

Tolerances: ± 0.010"

Sample Part Number Format: RC422-052-101-3000



SERIES
 Stackable
 Compliant
 Full-Profile
 4 Rows
 0.075" Spacing



CONFIGURATION
 028 – 4 Rows/7 Columns
 052 – 4 Rows/13 Columns
 076 – 4 Rows/19 Columns
 100 – 4 Rows/25 Columns
 128 – 4 Rows/32 Columns
 152 – 4 Rows/38 Columns
 200 – 4 Rows/50 Columns
 252 – 4 Rows/63 Columns
 300 – 4 Rows/75 Columns

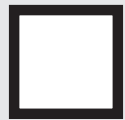

CONTACT
 10 - 0.095" Long



PLATING
 1 – 50 μ" Au
 3 – 30 μ" Au
 7 – 50 μ" Au / 20 μ" Au
 9 – 30 μ" Au / 20 μ" Au



HARDWARE
 30 - 0.195" Long
 (use with #10 contact)



TYPE
 00 – None
 FT – Female thread

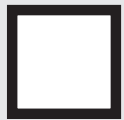

VARIATION
 Blank – None
 XXX – Consult factory



PLEASE CONSULT THE AIRBORNE WEBSITE FOR THE LATEST REVISION OF THIS DOCUMENT PRIOR TO BEGINNING ANY DESIGN WORK.

MATED HEIGHT

The connector body height is 0.300" and, when used with the -20 or -30 (0.270") contact, the mounting is flush (board-bottom-mounted to connector top). This board-bottom to connector-top spacing can be modified based on the contact selected by approximately the difference in pin length (see Table 2 in top window).

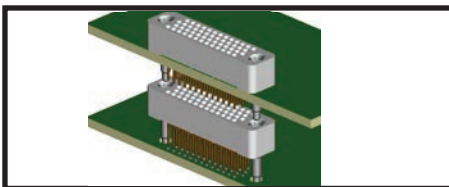
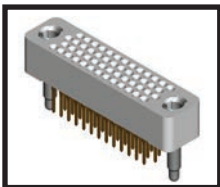

MATERIALS and FINISHES

Contact:BeCu per ASTM B768 (BeCu C17410 brush alloy 174)
 Contact Finish: Gold per MIL-G-45204 over nickel per IAW QQ-N-290
 Molded Insulator: Glass-filled polyphenylene sulfide (PPS) per MIL-M-24519
 Hardware: Stainless steel per ASTM A582, passivated per ASTM 967
 Guide Pin/Socket: BeCu per ASTM B196/197, nickel-plated per QQ-N-290

NOTE: AirBorn can manufacture special configurations to your exact specifications.

PERFORMANCE

Contact Rating: 3 amperes
 Operating Temperature: -65° C to +125° C
 Insulation Resistance: 5,000 megaohms minimum @ 500 VDC
 Durability: 500 connector mating cycles
 Contact Resistance: 3 to 5 milliohms (contact length-dependent)
 Contact Engagement Force: 4.0 oz (113 g) max. w/0.0246" dia. test pin
 Contact Separation Force: 0.5 oz (14 g) min. w/0.0226" dia. test pin
 Compliant Insertion Force: 22.5 lb (10.21 Kg) max. per contact
 Compliant Removal Force: 4.5 lb (2.04 Kg) min. per contact

SI DATA – Differential 100 Ohm

| | | |
|---|----------------------|------------------|
| 1 | Diff. Insertion Loss | 5.0 GHz @ -3 dB |
| 2 | Diff. Return Loss | 2.0 GHz @ -8 dB |
| 3 | NEXT | 4.0 GHz @ -25 dB |
| 4 | FEXT | 4.0 GHz @ -35 dB |



RC442 - Low Profile Board-to-Board Stackable Connector

Contact spacing: 0.075" (1.91 mm)

A low profile bodied, high-density press-fit connector. Uses a patented female/compliant/male stacking contact system. Used in board-to-board stacking applications.

DIMENSIONS

| SIZE | A | B | C |
|------|-------|-------|-------|
| 28 | 1.014 | 0.784 | 0.450 |
| 52 | 1.464 | 1.234 | 0.900 |
| 76 | 1.914 | 1.684 | 1.350 |
| 100 | 2.364 | 2.134 | 1.800 |
| 128 | 2.889 | 2.659 | 2.325 |
| 152 | 3.339 | 3.109 | 2.775 |
| 200 | 4.239 | 4.009 | 3.675 |
| 252 | 5.214 | 4.984 | 4.650 |
| 300 | 6.114 | 5.884 | 5.550 |

Tolerances: ± 0.010"

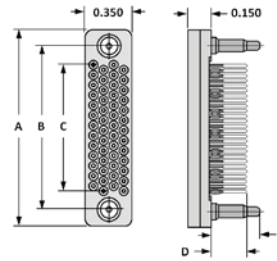

| CONTACT SELECTION | CONTACT D | HARDWARE E |
|-------------------|-----------|------------|
| 30 | 0.270 | 0.370 |
| 31 | 0.300 | 0.400 |
| 32 | 0.400 | 0.500 |
| 33 | 0.500 | 0.600 |
| 34 | 0.700 | 0.800 |
| 35 | 0.800 | 0.900 |
| 36 | 0.900 | 1.000 |
| 37 | 0.600 | 0.700 |
| 38 | 1.000 | 1.100 |

Sample Part Number Format: RC442-052-311-4000



SERIES
 Stackable
 Compliant
 Low-Profile
 4 Rows
 0.075" Spacing



CONFIGURATION
 028 - 4 Rows/7 Columns
 052 - 4 Rows/13 Columns
 076 - 4 Rows/19 Columns
 100 - 4 Rows/25 Columns
 128 - 4 Rows/32 Columns
 152 - 4 Rows/38 Columns
 200 - 4 Rows/50 Columns
 252 - 4 Rows/63 Columns
 300 - 4 Rows/75 Columns



PLATING
 1 - 50 μ" Au
 3 - 30 μ" Au
 7 - 50 μ" Au / 20 μ" Au
 9 - 30 μ" Au / 20 μ" Au



TYPE
 00 - None



VARIATION
 Blank - None
 XXX - Consult factory

CONTACT
 30 - 0.270" Long
 31 - 0.300" Long
 32 - 0.400" Long
 33 - 0.500" Long
 34 - 0.700" Long
 35 - 0.800" Long
 36 - 0.900" Long
 37 - 0.600" Long
 38 - 1.000" Long

HARDWARE
 39 - 0.370" Long (use with #30 contact)
 40 - 0.400" Long (use with #31 contact)
 41 - 0.500" Long (use with #32 contact)
 42 - 0.600" Long (use with #33 contact)
 43 - 0.800" Long (use with #34 contact)
 44 - 0.900" Long (use with #35 contact)
 45 - 1.000" Long (use with #36 contact)
 46 - 0.700" Long (use with #37 contact)
 47 - 1.100" Long (use with #38 contact)



PLEASE CONSULT THE AIRBORNE WEBSITE FOR THE LATEST REVISION OF THIS DOCUMENT PRIOR TO BEGINNING ANY DESIGN WORK.

MATED HEIGHT

The connector body height is 0.150" but the functional spacing (the bottom surface of the board, on which the connector is mounted, to the top of the connector below it) can be modified based on the contact/pin length selected (see Table 2 in top window).

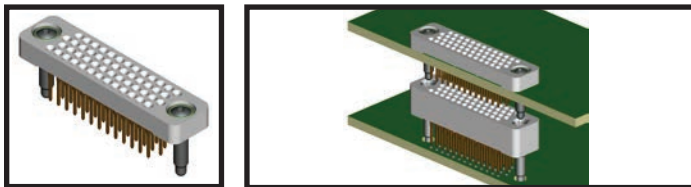

MATERIALS and FINISHES

Contact: BeCu per ASTM B768 (BeCu C17410 brush alloy 174)
 Contact Finish: Gold per MIL-G-45204 over nickel per IAW QQ-N-290
 Molded Insulator: Glass-filled polyphenylene sulfide (PPS) per MIL-M-24519
 Hardware: Stainless steel per ASTM A582, passivated per ASTM 967
 Guide Pin/Socket: BeCu per ASTM B196/197, nickel-plated per QQ-N-290

NOTE: AirBorn can manufacture special configurations to your exact specifications.

PERFORMANCE

Contact Rating: 3 amperes
 Operating Temperature: -65° C to +125° C
 Insulation Resistance: 5,000 megaohms minimum @ 500 VDC
 Durability: 500 connector mating cycles
 Contact Resistance: 3 to 5 milliohms (contact length dependent)
 Contact Engagement Force: 4.0 oz (113 g) max. w/0.0246" dia. test pin
 Contact Separation Force: 0.5 oz (14 g) min. w/0.0226" dia. test pin
 Compliant Insertion Force: 22.5 lb (10.21 Kg) max. per contact
 Compliant Removal Force: 4.5 lb (2.04 Kg) min. per contact

SI DATA - Differential 100 Ohm

| | | |
|---|----------------------|------------------|
| 1 | Diff. Insertion Loss | 5.0 GHz @ -3 dB |
| 2 | Diff. Return Loss | 2.0 GHz @ -8 dB |
| 3 | NEXT | 4.0 GHz @ -25 dB |
| 4 | FEXT | 4.0 GHz @ -35 dB |



RC4B2 - Bottom-of-Stack Cable Mating Connector (Female)

Contact spacing: 0.075" (1.91 mm)

A full profile bodied female cable connector for use at the bottom of an RC board stack application.

DIMENSIONS

| TABLE 1 | | | |
|---------|-------|-------|-------|
| SIZE | A | B | C |
| 28 | 1.014 | 0.784 | 0.450 |
| 52 | 1.464 | 1.234 | 0.900 |
| 76 | 1.914 | 1.684 | 1.350 |
| 100 | 2.364 | 2.134 | 1.800 |
| 128 | 2.889 | 2.659 | 2.325 |
| 152 | 3.339 | 3.109 | 2.775 |

Tolerances: ± 0.010"

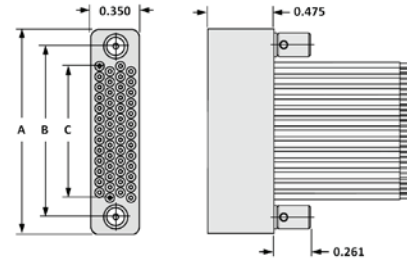

Sample Part Number Format: RC4B2-052-281-62ED



SERIES
 Stackable
 Compliant
 Full-Profile
 4 Rows
 0.075" Spacing
 Bottom-of-Stack
 Cable Female



CONFIGURATION
 028 – 4 Rows/7 Columns
 052 – 4 Rows/13 Columns
 076 – 4 Rows/19 Columns
 100 – 4 Rows/25 Columns
 128 – 4 Rows/32 Columns
 152 – 4 Rows/38 Columns



CONTACT
 28 – Socket, crimp, 26-24 AWG
 29 – Socket, crimp, 30-28 AWG



PLATING
 1 – 50 μ" Au
 3 – 30 μ" Au



HARDWARE
 00 – None
 58 – Guide socket, non-polarized
 62 – Jacksocket, hex, turning



TYPE
 00 – None
 XX – See Wire Codes



VARIATION
 Blank – None
 XXX – Consult factory

WIRE CODES

| TYPE and COLOR | | | LENGTH | |
|----------------|--------|---------------|--------|------------------|
| Code | Size | Color | Code | Length (+1"/-0") |
| Mil-W-16878/4 | | | | |
| C | 24 awg | Ten repeating | A | 6" |
| D | 24 awg | White | B | 12" |
| E | 26 awg | Ten repeating | C | 18" |
| F | 26 awg | White | D | 24" |
| G | 28 awg | Ten repeating | E | 30" |
| H | 28 awg | White | F | 36" |
| J | 30 awg | Ten repeating | G | 42" |
| K | 30 awg | White | H | 48" |
| Mil-W-22759/33 | | | | |
| N | 24 awg | Ten repeating | J | 54" |
| P | 24 awg | White | K | 60" |
| R | 26 awg | Ten repeating | L | 66" |
| S | 26 awg | White | M | 72" |
| T | 28 awg | Ten repeating | N | 84" |
| U | 28 awg | White | P | 96" |
| V | 30 awg | Ten repeating | R | 108" |
| W | 30 awg | White | S | 120" |

PLEASE CONSULT THE AIRBORNE WEBSITE FOR THE LATEST REVISION OF THIS DOCUMENT PRIOR TO BEGINNING ANY DESIGN WORK.

MATED HEIGHT

Connector body height is 0.475" and is designed to mount flush to the board bottom of the mating connector.

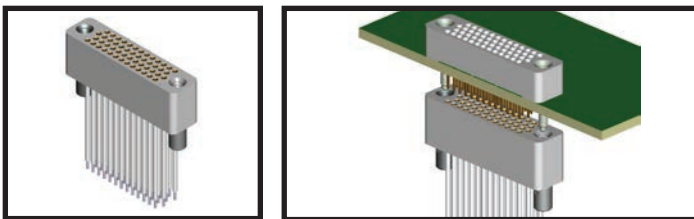

NOTES

- The RC4B2 connector is designed to mate with an RC422 connector using contact option -21 (0.270" long) and -39MT hardware. This contact length and hardware combination assures proper connector mating when using boards having a thickness of 0.058"–0.125".
- When guide hardware is required on the RC4B2 connector, use hardware option -3900 on the mating connector.
- When jacksocket hardware is required on the RC4B2 connector, use hardware option -39MT on the mating connector.

MATERIALS and FINISHES

Contact: BeCu per ASTM B196 or B197 (BeCu alloy 172 or 173)
 Contact Finish: Gold per MIL-G-45204 over nickel per QQ-N-290
 Molded Insulator: Glass-filled polyphenylene sulfide (PPS) per MIL-M-24519
 Hardware: Stainless steel per ASTM A484/A484M and ASTM A582/A582M, passivated per SAE AMS-2700

NOTE: AirBorn can manufacture special configurations to your exact specifications.

PERFORMANCE

Contact Rating: 3 amperes
 Operating Temperature: -65° C to +125° C
 Insulation Resistance: 5,000 megaohms minimum @ 500 VDC
 Durability: 500 connector mating cycles
 Contact Resistance: 3 to 5 milliohms (contact length dependent)
 Contact Engagement Force: 4.0 oz (113 g) max. w/0.0248" dia. test pin
 Contact Separation Force: 0.5 oz (14 g) min. w/0.0226" dia. test pin



RC4C2 - Top-of-Stack Cable Mating Connector (Male)

Contact spacing: 0.075" (1.91 mm)

A full profile bodied male pre-wired cable connector for use at the top of an RC board stack application.

DIMENSIONS

| SIZE | A | B | C |
|------|-------|-------|-------|
| 28 | 1.014 | 0.784 | 0.450 |
| 52 | 1.464 | 1.234 | 0.900 |
| 76 | 1.914 | 1.684 | 1.350 |
| 100 | 2.364 | 2.134 | 1.800 |
| 128 | 2.889 | 2.659 | 2.325 |
| 152 | 3.339 | 3.109 | 2.775 |

Tolerances: ± 0.010"

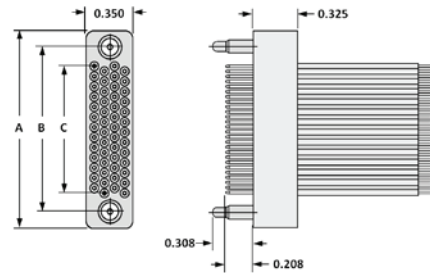

Sample Part Number Format: RC4C2-052-181-57ED



SERIES
 Stackable
 Compliant
 Full-Profile
 4 Rows
 0.075" Spacing
 Top-of-Stack
 Cable Mate



CONFIGURATION
 028 – 4 Rows/7 Columns
 052 – 4 Rows/13 Columns
 076 – 4 Rows/19 Columns
 100 – 4 Rows/25 Columns
 128 – 4 Rows/32 Columns
 152 – 4 Rows/38 Columns



PLATING
 1 – 50 μ" Au
 3 – 30 μ" Au

CONTACT
 18 – Pin, crimp, 26-24 AWG
 19 – Pin, crimp, 30-28 AWG



HARDWARE
 00 – None
 57 – Guide pin, non-polarized
 61 – Jackscrew, hex, turning*



TYPE
 XX – See Wire Codes



VARIATION
 Blank – None
 XXX – Consult factory

WIRE CODES

| TYPE and COLOR | | | LENGTH | |
|-----------------------|--------|---------------|--------|------------------|
| Code | Size | Color | Code | Length (+1"/-0") |
| Mil-W-16878/4 | | | | |
| C | 24 awg | Ten repeating | A | 6" |
| D | 24 awg | White | B | 12" |
| E | 26 awg | Ten repeating | C | 18" |
| F | 26 awg | White | D | 24" |
| G | 28 awg | Ten repeating | E | 30" |
| H | 28 awg | White | F | 36" |
| J | 30 awg | Ten repeating | G | 42" |
| K | 30 awg | White | H | 48" |
| Mil-W-22759/33 | | | | |
| N | 24 awg | Ten repeating | J | 54" |
| P | 24 awg | White | K | 60" |
| R | 26 awg | Ten repeating | L | 66" |
| S | 26 awg | White | M | 72" |
| T | 28 awg | Ten repeating | N | 84" |
| U | 28 awg | White | P | 96" |
| V | 30 awg | Ten repeating | R | 108" |
| W | 30 awg | White | S | 120" |

PLEASE CONSULT THE AIRBORN WEBSITE FOR THE LATEST REVISION OF THIS DOCUMENT PRIOR TO BEGINNING ANY DESIGN WORK.

MATED HEIGHT

Connector body height is 0.325" and is designed to mount flush to the mating connector.

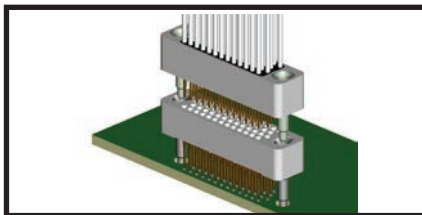
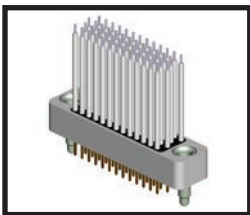

NOTES

* To use the -61 jackscrew hardware option, the fixed jacknut hardware (-XXMT) must be in place on the mating board connector.

MATERIALS and FINISHES

Contact: BeCu per ASTM B196 or B197 (BeCu alloy 172 or 173)
 Contact Finish: Gold per MIL-G-45204 over nickel per QQ-N-290
 Molded Insulator: Glass-filled polyphenylene sulfide (PPS) per MIL-M-24519
 Hardware: Stainless steel per ASTM A484/A484M and ASTM A582/A582M, passivated per SAE AMS-2700

NOTE: AirBorn can manufacture special configurations to your exact specifications.

PERFORMANCE

Contact Rating: 3 amperes
 Operating Temperature: -65° C to +125° C
 Insulation Resistance: 5,000 megaohms minimum @ 500 VDC
 Durability: 500 connector mating cycles
 Contact Resistance: 3 to 5 milliohms (contact length dependent)
 Contact Engagement Force: 4.0 oz (113 g) max. w/0.0248" dia. test pin
 Contact Separation Force: 0.5 oz (14 g) min. w/0.0226" dia. test pin



RC4C2 - Top-of-Stack Flex Circuit Mating Connector (Male)

Contact spacing: 0.075" (1.91 mm)

A full profile bodied flex-circuit-ready male connector for use at the top of an RC board stack application.

DIMENSIONS

| TABLE 1 | | | |
|---------|-------|-------|-------|
| SIZE | A | B | C |
| 28 | 1.014 | 0.784 | 0.450 |
| 52 | 1.464 | 1.234 | 0.900 |
| 76 | 1.914 | 1.684 | 1.350 |
| 100 | 2.364 | 2.134 | 1.800 |
| 128 | 2.889 | 2.659 | 2.325 |
| 152 | 3.339 | 3.109 | 2.775 |

Tolerances: ± 0.010"

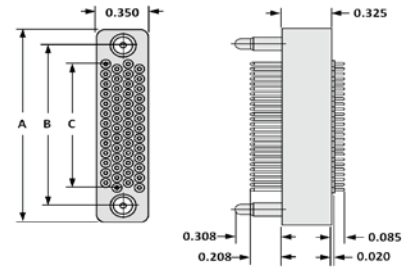

Sample Part Number Format: RC4C2-052-151-5700



SERIES
 Stackable
 Compliant
 Full-Profile
 4 Rows
 0.075" Spacing
 Top-of-Stack
 Cable Mate

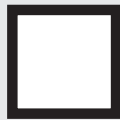

CONFIGURATION
 028 – 4 Rows/7 Columns
 052 – 4 Rows/13 Columns
 076 – 4 Rows/19 Columns
 100 – 4 Rows/25 Columns
 128 – 4 Rows/32 Columns
 152 – 4 Rows/38 Columns



CONTACT
 15 – Pin, flex circuit



PLATING
 1 – 50 μ" Au
 3 – 30 μ" Au

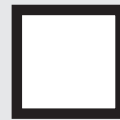

HARDWARE
 00 – None
 57 – Guide pin, non-polarized
 61 – Jackscrew, hex, turning*



TYPE
 00 – None



VARIATION
 Blank – None
 XXX – Consult factory



PLEASE CONSULT THE AIRBORN WEBSITE FOR THE LATEST REVISION OF THIS DOCUMENT PRIOR TO BEGINNING ANY DESIGN WORK.

MATED HEIGHT

Connector body height is 0.325" and is designed to mount flush to the mating connector.

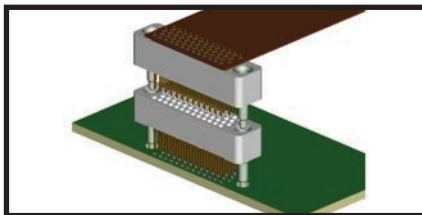
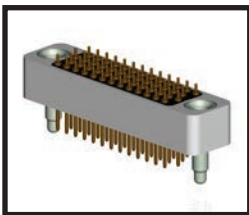

MATERIALS and FINISHES

Contact: BeCu per ASTM B196 or B197 (BeCu alloy 172 or 173)
 Contact Finish: Gold per MIL-G-45204 over nickel per QQ-N-290
 Molded Insulator: Glass-filled polyphenylene sulfide (PPS) per MIL-M-24519
 Hardware: Stainless steel per ASTM A484/A484M and ASTM A582/A582M,
 passivated per SAE AMS-2700

NOTE: AirBorn can manufacture special configurations to your exact specifications.

PERFORMANCE

Contact Rating: 3 amperes
 Operating Temperature: -65° C to +125° C
 Insulation Resistance: 5,000 megaohms minimum @ 500 VDC
 Durability: 500 connector mating cycles
 Contact Resistance: 3 to 5 milliohms (contact length dependent)
 Contact Engagement Force: 4.0 oz (113 g) max. w/0.0246" dia. test pin
 Contact Separation Force: 0.5 oz (14 g) min. w/0.0226" dia. test pin

NOTES

* To use the -61 jackscrew hardware option, the fixed jacknut hardware (-XXMT) must be in place on the mating board connector.



RC4C2 - Top-of-Stack Solder Cup Cable Mating Connector (Male)

Contact spacing: 0.075" (1.91 mm)

A full profile bodied male wire-ready connector for use at the top of an RC board stack application.

DIMENSIONS

| TABLE 1 | | | |
|---------|-------|-------|-------|
| SIZE | A | B | C |
| 28 | 1.014 | 0.784 | 0.450 |
| 52 | 1.464 | 1.234 | 0.900 |
| 76 | 1.914 | 1.684 | 1.350 |
| 100 | 2.364 | 2.134 | 1.800 |
| 128 | 2.889 | 2.659 | 2.325 |
| 152 | 3.339 | 3.109 | 2.775 |

Tolerances: ± 0.010"

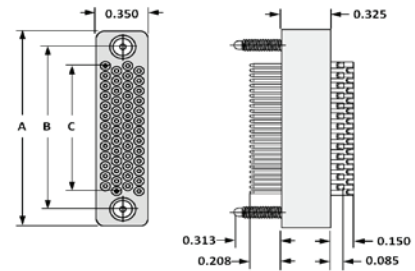

Sample Part Number Format: RC4C2-052-111-6100



SERIES

Stackable
 Compliant
 Full-Profile
 4 Rows
 0.075" Spacing
 Top-of-Stack
 Cable Mate

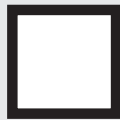

CONFIGURATION

028 – 4 Rows/7 Columns
 052 – 4 Rows/13 Columns
 076 – 4 Rows/19 Columns
 100 – 4 Rows/25 Columns
 128 – 4 Rows/32 Columns
 152 – 4 Rows/38 Columns



CONTACT

11 – Pin, solder cup



PLATING

1 – 50 μ" Au
 3 – 30 μ" Au

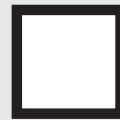

HARDWARE

00 – None
 57 – Guide pin, non-polarized
 61 – Jackscrew, hex, turning*



TYPE

00 – None



VARIATION

Blank – None
 XXX – Consult factory



PLEASE CONSULT THE AIRBORN WEBSITE FOR THE LATEST REVISION OF THIS DOCUMENT PRIOR TO BEGINNING ANY DESIGN WORK.

MATED HEIGHT

Connector body height is 0.325" and is designed to mount flush to the mating connector.

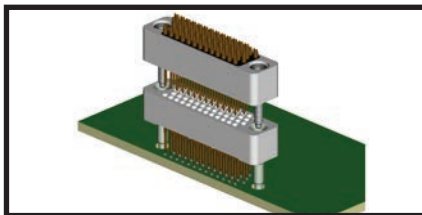
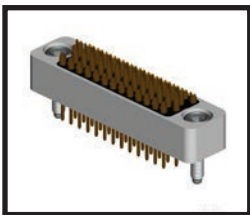

MATERIALS and FINISHES

Contact: BeCu per ASTM B196 or B197 (BeCu alloy 172 or 173)
 Contact Finish: Gold per MIL-G-45204 over nickel per QQ-N-290
 Molded Insulator: Glass-filled polyphenylene sulfide (PPS) per MIL-M-24519
 Hardware: Stainless steel per ASTM A484/A484M and ASTM A582/A582M, passivated per SAE AMS-2700

NOTE: AirBorn can manufacture special configurations to your exact specifications.

PERFORMANCE

Contact Rating: 3 amperes
 Operating Temperature: -65° C to +125° C
 Insulation Resistance: 5,000 megaohms minimum @ 500 VDC
 Durability: 500 connector mating cycles
 Contact Resistance: 3 to 5 milliohms (contact length dependent)
 Contact Engagement Force: 4.0 oz (113 g) max. w/0.0246" dia. test pin
 Contact Separation Force: 0.5 oz (14 g) min. w/0.0226" dia. test pin

NOTES

* To use the -61 jackscrew hardware option, the fixed jacknut hardware (-XXMT) must be in place on the mating board connector.



RC 4-ROW DIMENSIONS

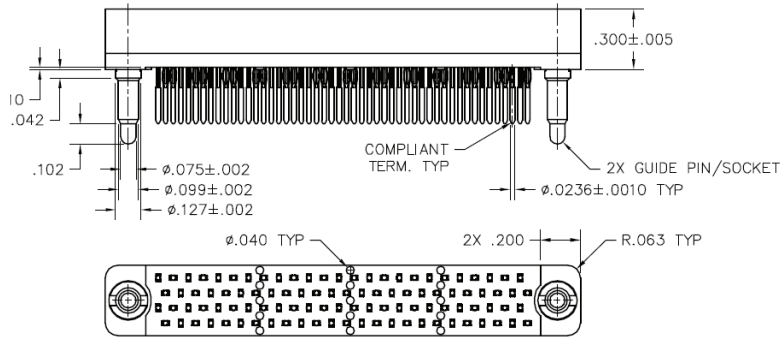
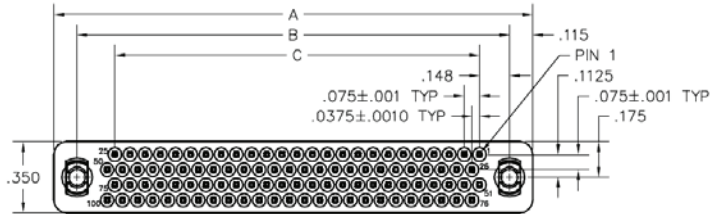

BODY STYLE
422

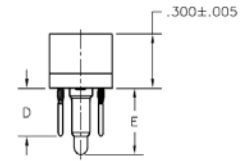

BODY STYLE
422

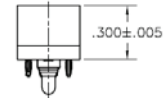

CONTACT/HARDWARE
OPTION 101
(TERMINATES CIRCUIT)

BODY STYLE
442

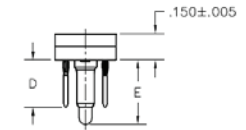

OPTIONAL INSULATOR FOR TOP CONNECTOR
WITH TERMINATION OPTIONS: 301, 311, 321,
331, 341, 351, 361, 371 AND 381
(w/CIRCUIT TEST POINT).

| DIMENSIONS | | | |
|------------|-------|-------|-------|
| SIZE | A | B | C |
| 28 | 1.014 | 0.784 | 0.450 |
| 52 | 1.464 | 1.234 | 0.900 |
| 76 | 1.914 | 1.684 | 1.350 |
| 100 | 2.364 | 2.134 | 1.800 |
| 128 | 2.889 | 2.659 | 2.325 |
| 152 | 3.339 | 3.109 | 2.775 |
| 200 | 4.239 | 4.009 | 3.675 |
| 252 | 5.214 | 4.984 | 4.650 |
| 300 | 6.114 | 5.884 | 5.500 |

| TABLE 1 | | |
|---------------------|-----------|------------|
| CONTACT TERMINATION | CONTACT D | HARDWARE E |
| 201, 301 | 0.270 | 0.370 |
| 211, 311 | 0.300 | 0.400 |
| 221, 321 | 0.400 | 0.500 |
| 231, 331 | 0.500 | 0.600 |
| 241, 341 | 0.700 | 0.800 |
| 251, 351 | 0.800 | 0.900 |
| 261, 361 | 0.900 | 1.000 |
| 271, 371 | 0.600 | 0.700 |
| 281, 381 | 1.000 | 1.100 |
| 101 | 0.095 | 0.195 |

PWB-PLATED THRU-HOLE RECOMMENDATIONS:

Board material: FR-4 (or equivalent) with 1.0 oz. copper

Board thickness: 0.058" minimum

Drilled hole: Ø 0.033"

Copper plating thickness: 0.0020"

Tin-lead plating thickness: 0.0005"

Finished hold diameter: Ø 0.028" (Ø 0.028" ±0.002" required)



RC 4-ROW DRAWINGS

Board Footprint and Dimensions

| SIZE | CONTACT ID | SIZE | CONTACT ID |
|------|------------|------|------------|
| 28 | | 152 | |
| 52 | | 200 | |
| 76 | | 252 | |
| 100 | | 300 | |
| 128 | | | |

| DIMENSIONS | | | |
|------------|-------|-------|-------|
| SIZE | A | B | C |
| 28 | 1.014 | 0.784 | 0.450 |
| 52 | 1.464 | 1.234 | 0.900 |
| 76 | 1.914 | 1.684 | 1.350 |
| 100 | 2.364 | 2.134 | 1.800 |
| 128 | 2.889 | 2.659 | 2.325 |
| 152 | 3.339 | 3.109 | 2.775 |
| 200 | 4.239 | 4.009 | 3.675 |
| 252 | 5.214 | 4.984 | 4.650 |
| 300 | 6.114 | 5.884 | 5.500 |

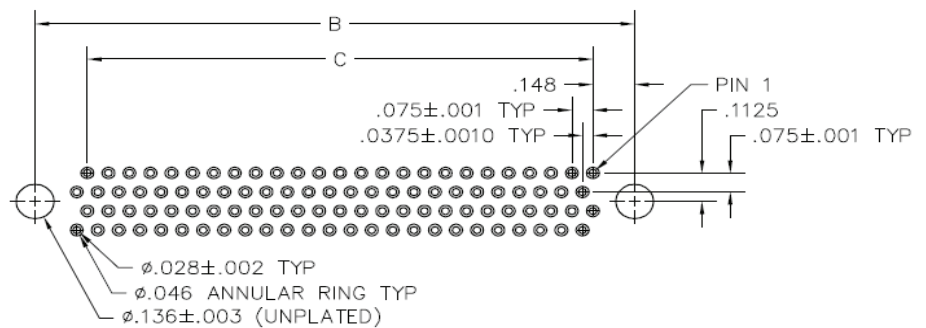

PWB-PLATED THRU-HOLE RECOMMENDATIONS:

Board material: FR-4 (or equivalent) with 1.0 oz. copper
 Board thickness: 0.058" minimum
 Drilled hole: $\phi 0.033$ "

Copper plating thickness: 0.0020"
 Tin-lead plating thickness: 0.0005"
 Finished hold diameter: $\phi 0.028$ " ($\phi 0.028$ " ± 0.002 " required)



RC 4-ROW DIMENSIONS

Plating Options

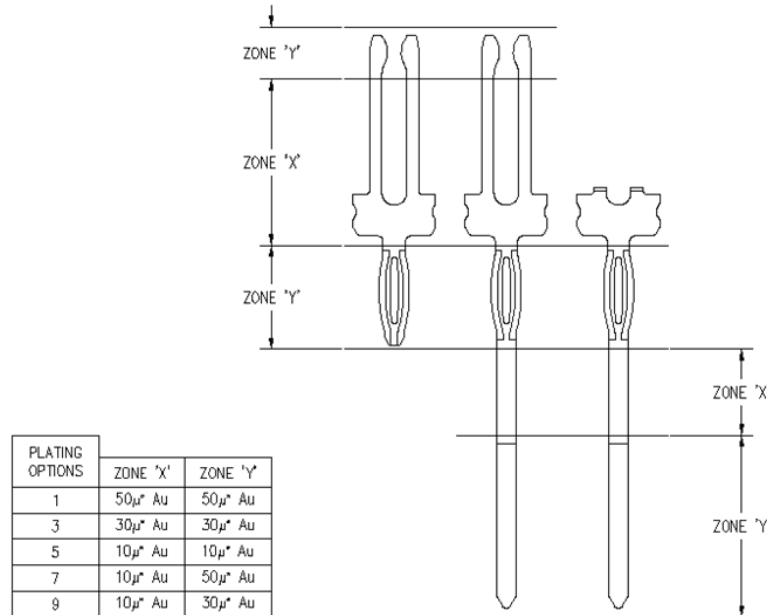

Determining the Required Termination Lead Length

To calculate the required termination lead length, use the example below. Measurements listed are in inches.

Dimension A = 0.720
 $0.720 - 0.300$ (insulator height) = 0.420
 $0.420 + 0.114$ (minimum pin engagement) = 0.534
 $0.420 + 0.214$ (maximum pin engagement) = 0.634

In this example, the termination option to choose is 0.600 lead length.

The contact termination option will be a length that falls between the calculated numbers resulting from using the minimum and maximum pin engagement.

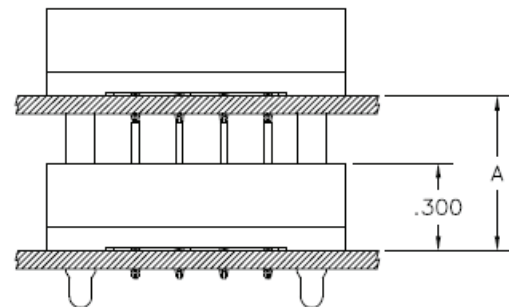

PWB-PLATED THRU-HOLE RECOMMENDATIONS:

Board material: FR-4 (or equivalent) with 1.0 oz. copper
 Board thickness: 0.058" minimum
 Drilled hole: \varnothing 0.033"

Copper plating thickness: 0.0020"
 Tin-lead plating thickness: 0.0005"
 Finished hold diameter: \varnothing 0.028" (\varnothing 0.028" \pm 0.002" required)



RC 4-ROW DRAWINGS

Stacking Detail

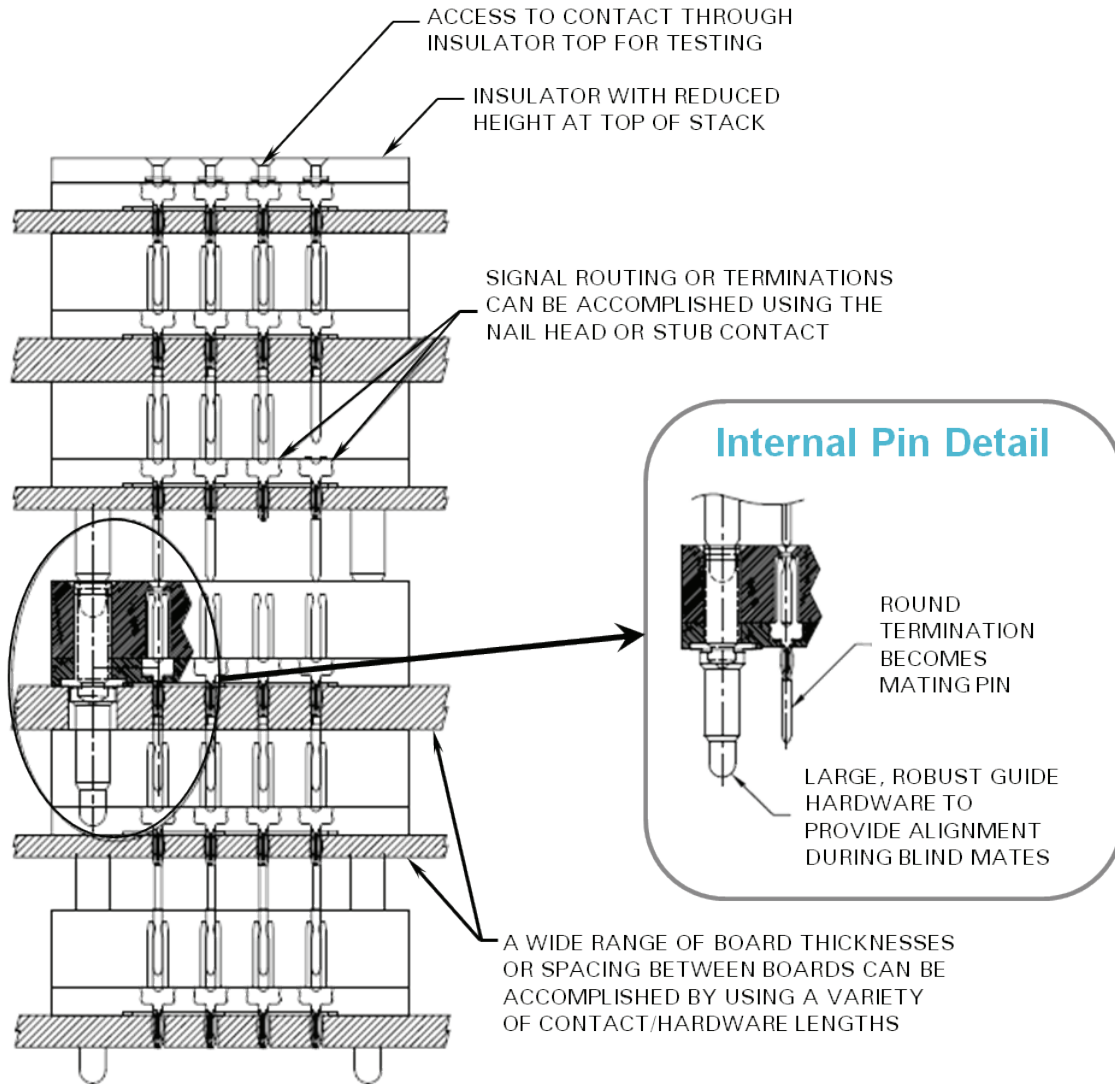

PWB-PLATED THRU-HOLE RECOMMENDATIONS:

Board material: FR-4 (or equivalent) with 1.0 oz. copper

Board thickness: 0.058" minimum

Drilled hole: \varnothing 0.033"

Copper plating thickness: 0.0020"

Tin-lead plating thickness: 0.0005"

Finished hold diameter: \varnothing 0.028" (\varnothing 0.028" \pm 0.002" required)



RC 4-ROW, BOTTOM-COMPLIANT DIMENSIONS

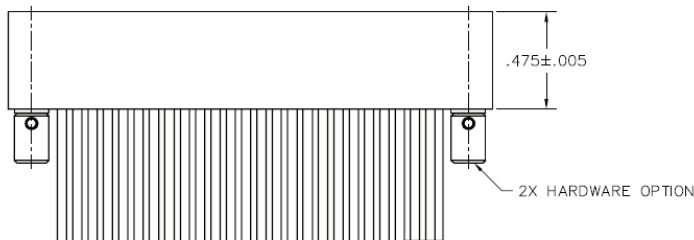
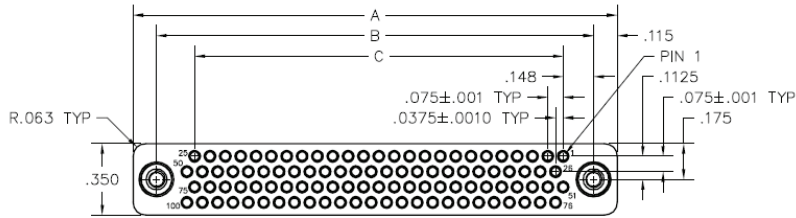

| DIMENSIONS | | | |
|------------|-------|-------|-------|
| SIZE | A | B | C |
| 28 | 1.014 | 0.784 | 0.450 |
| 52 | 1.464 | 1.234 | 0.900 |
| 76 | 1.914 | 1.684 | 1.350 |
| 100 | 2.364 | 2.134 | 1.800 |
| 128 | 2.889 | 2.659 | 2.325 |
| 152 | 3.339 | 3.109 | 2.775 |
| 200 | 4.239 | 4.009 | 3.675 |

GUIDE SOCKET



HARDWARE STYLE 58

#2-56 JACKSOCKET



HARDWARE STYLE 62

PWB-PLATED THRU-HOLE RECOMMENDATIONS:

Board material: FR-4 (or equivalent) with 1.0 oz. copper

Board thickness: 0.058" minimum

Drilled hole: Ø 0.033"

Copper plating thickness: 0.0020"

Tin-lead plating thickness: 0.0005"

Finished hold diameter: Ø 0.028" (Ø 0.028" ±0.002" required)



RC 4-ROW, BOTTOM-COMPLIANT DRAWINGS

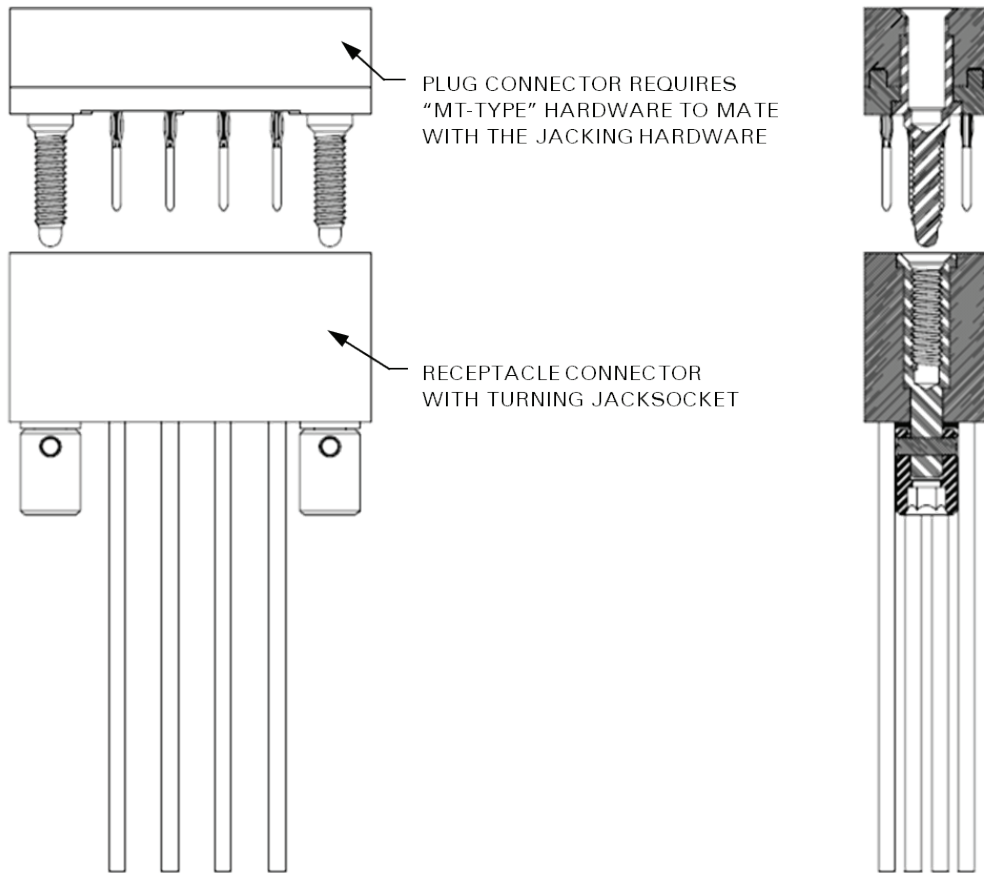

PWB-PLATED THRU-HOLE RECOMMENDATIONS:

Board material: FR-4 (or equivalent) with 1.0 oz. copper

Board thickness: 0.058" minimum

Drilled hole: \varnothing 0.033"

Copper plating thickness: 0.0020"

Tin-lead plating thickness: 0.0005"

Finished hold diameter: \varnothing 0.028" (\varnothing 0.028" \pm 0.002" required)



RC 4-ROW, TOP-COMPLIANT DIMENSIONS

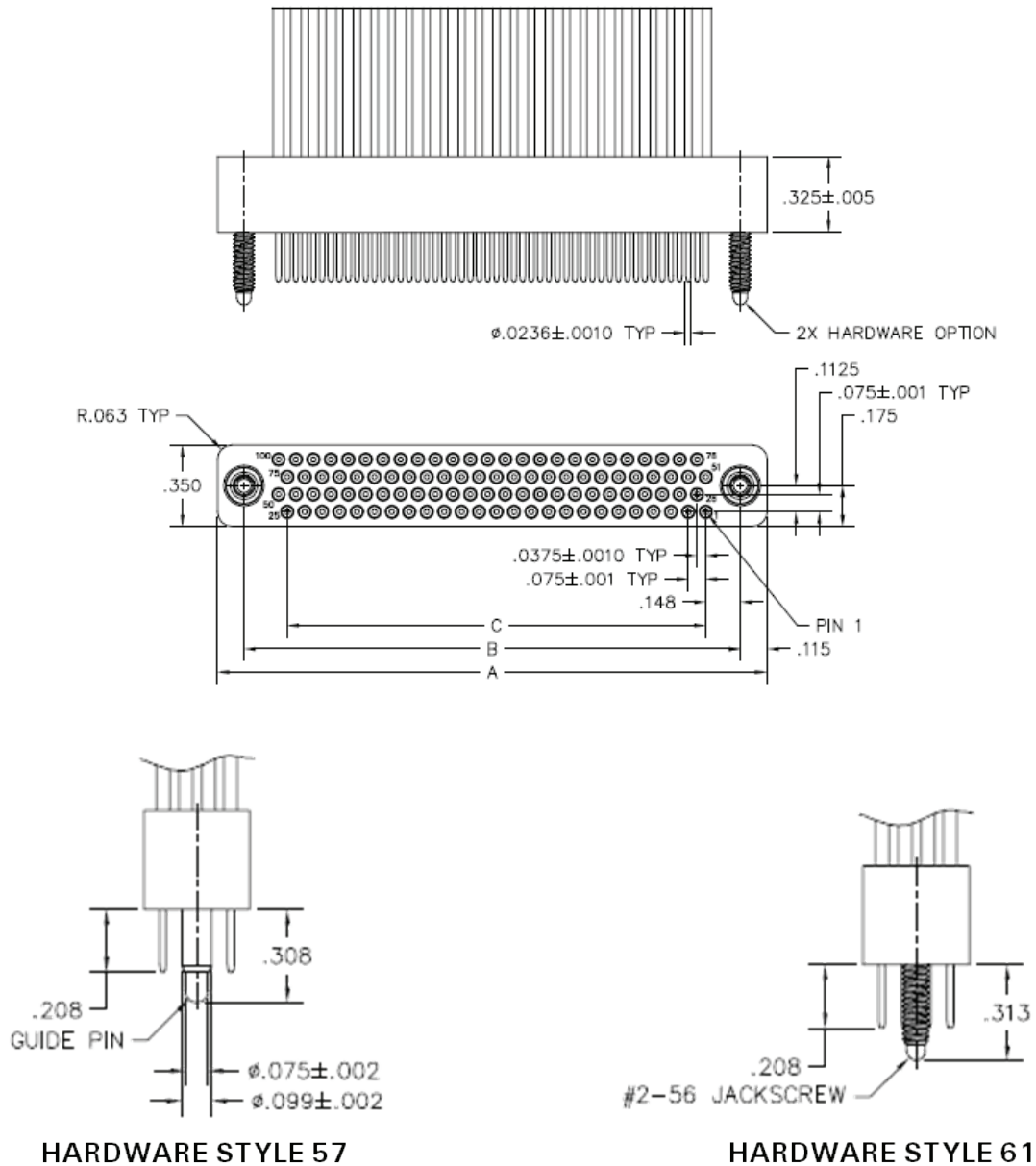

PWB-PLATED THRU-HOLE RECOMMENDATIONS:

Board material: FR-4 (or equivalent) with 1.0 oz. copper

Board thickness: 0.058" minimum

Drilled hole: Ø 0.033"

Copper plating thickness: 0.0020"

Tin-lead plating thickness: 0.0005"

Finished hold diameter: Ø 0.028" (Ø 0.028" ±0.002" required)



RC 4-ROW, TOP-COMPLIANT DRAWINGS

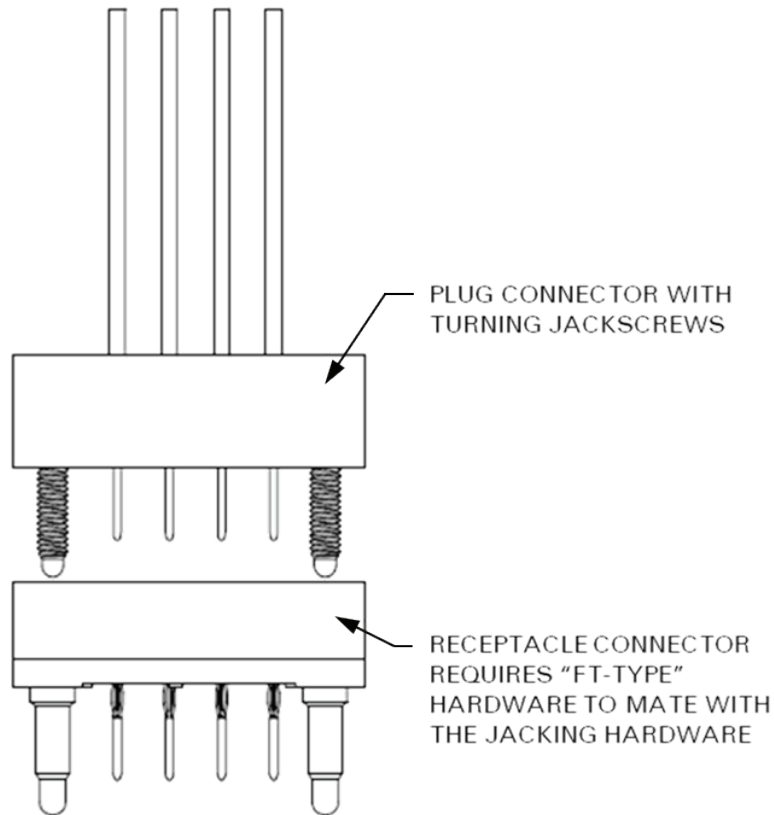

PWB-PLATED THRU-HOLE RECOMMENDATIONS:

Board material: FR-4 (or equivalent) with 1.0 oz. copper

Board thickness: 0.058" minimum

Drilled hole: \varnothing 0.033"

Copper plating thickness: 0.0020"

Tin-lead plating thickness: 0.0005"

Finished hold diameter: \varnothing 0.028" (\varnothing 0.028" \pm 0.002" required)

Mouser Electronics

Authorized Distributor

Click to View Pricing, Inventory, Delivery & Lifecycle Information:

[AirBorn:](#)

[RC422-100-201-3900](#)