

3.3V

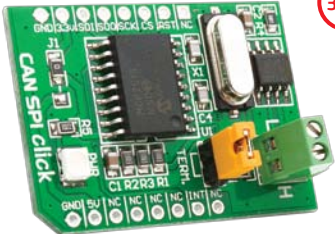

# CAN SPI click™

## 1. Introduction

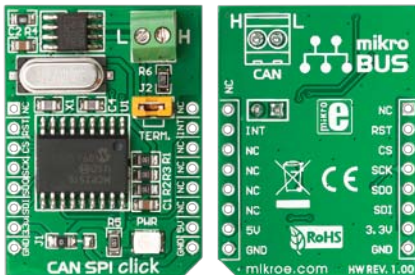

CAN SPI click 3.3V is an accessory board in **mikroBus™** form factor. It is the best solution for adding CAN connectivity to your microcontroller with SPI interface. Board features **SN65HVD230** CAN transceiver circuit which provides CAN serial communication physical layer in accordance with the ISO 11898 standard. It is designed for operation in especially-harsh environments, providing reliable solution. Board is designed to use 3.3V power supply only.

## 2. Soldering the headers

Before using your click board, make sure to solder the provided 1x8 male headers to both sides of the board. Two 1x8 male headers are included with the board in the package.



1

2

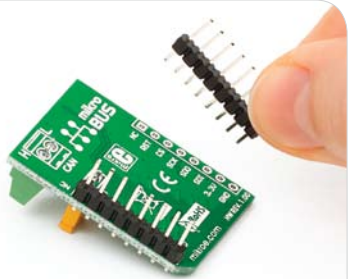

Turn the board upside down, so that bottom side is facing you upwards. Place shorter parts of the header pins in the both soldering pad locations.

3

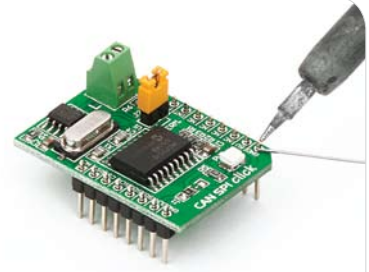

Turn the board upward again. Make sure to align the headers so that they are perpendicular to the board, then solder the pins carefully.

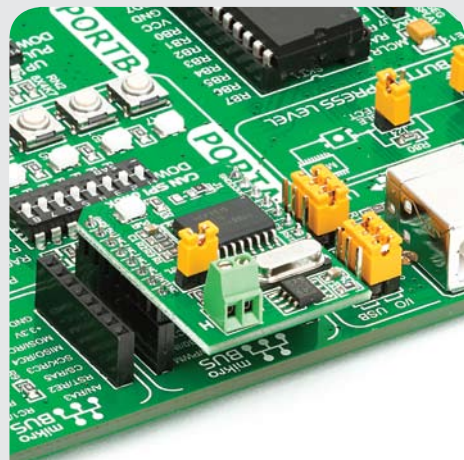

## 4. Features and applications

CAN SPI click board features **MCP2515** CAN controller with SPI interface and supports 1 Mb/s operation. Board also features screw terminals for easier connectivity, power LED and node termination jumper. It has low-current standby mode of 370  $\mu$ A typical. Mentioned features make this board ideal for industrial automation, home automation as well as in automotive and mobile machine industry.

## 3. Plugging the board in

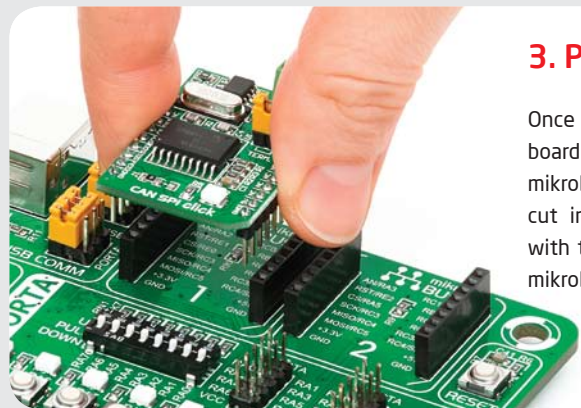

Once you have soldered the headers your board is ready to be placed into desired mikroBUS™ socket. Make sure to align the cut in the lower-right part of the board with the markings on the silkscreen at the mikroBUS™ socket. If all the pins are aligned correctly, push the board all the way into the socket.

click™  
BOARD  
[www.mikroe.com](http://www.mikroe.com)



CAN-SPI click 3.3V Manual  
ver. 1.00



0 100000 018125

## 5. CAN SPI click 3.3V Board Schematics

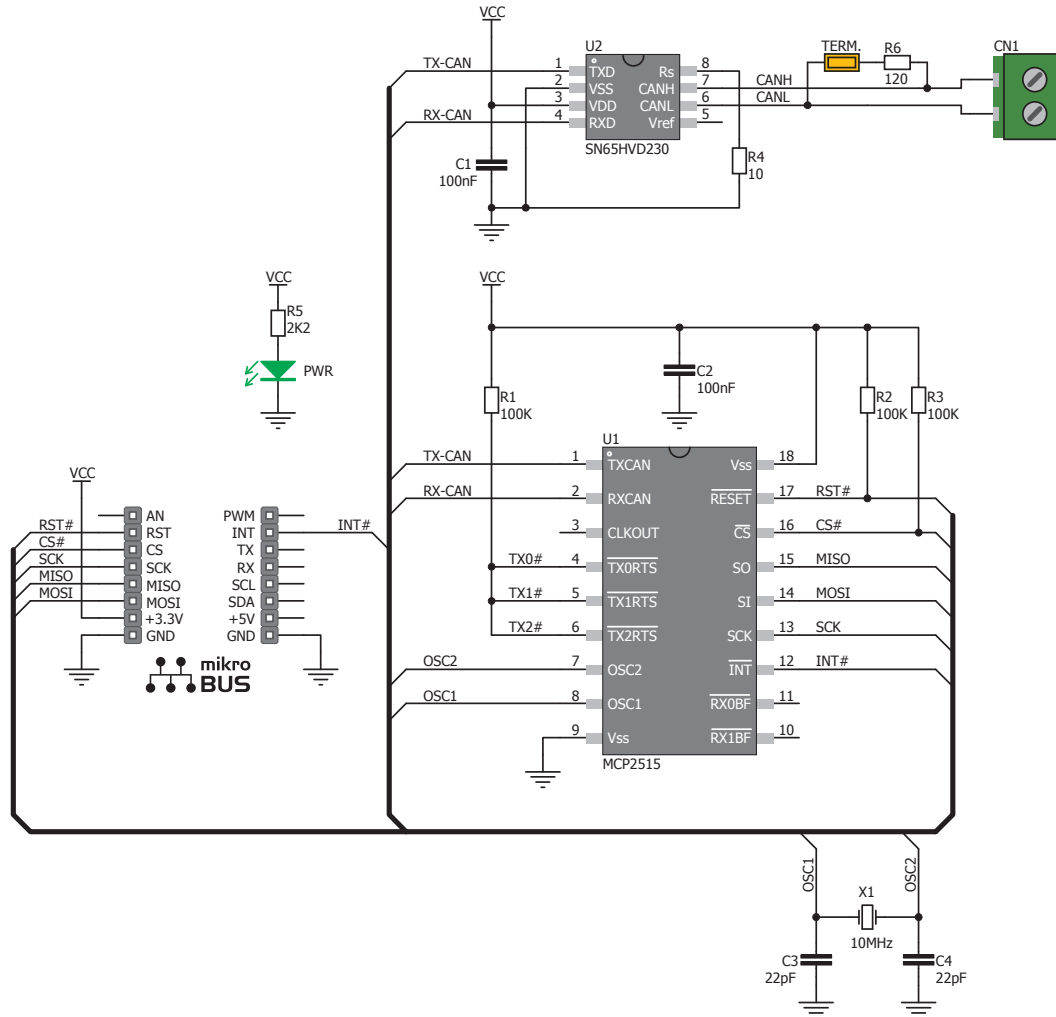

## 6. Node termination jumper

1. If the board is the first and the last node of the CAN network, then **J2** jumper should be placed.

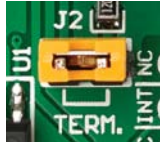

2. If the board is a node in the middle, jumper should be **removed**.

## 7. Code Examples

Once you have done all the necessary preparations, it's time to get your click board up and running. We have provided the examples for mikroC, mikroBasic and mikroPascal compilers on our **Libstock** website. Just download them and you are ready to start.



## 8. Support

MikroElektronika offers **Free Tech Support** ([www.mikroe.com/esupport](http://www.mikroe.com/esupport)) until the end of product lifetime, so if something goes wrong, we are ready and willing to help!

# Mouser Electronics

Authorized Distributor

Click to View Pricing, Inventory, Delivery & Lifecycle Information:

[MikroElektronika:](#)

[MIKROE-986](#)