

## Turbo 2 ultrafast - high voltage rectifier for SMPS

### Features

- Ultrafast switching
- Low reverse current
- Low thermal resistance
- Reduces conduction and switching losses

### Description

The STTH10LCD06C uses ST Turbo2 technology. This device is specially suited for switching power supplies working with interleaved PFCs.

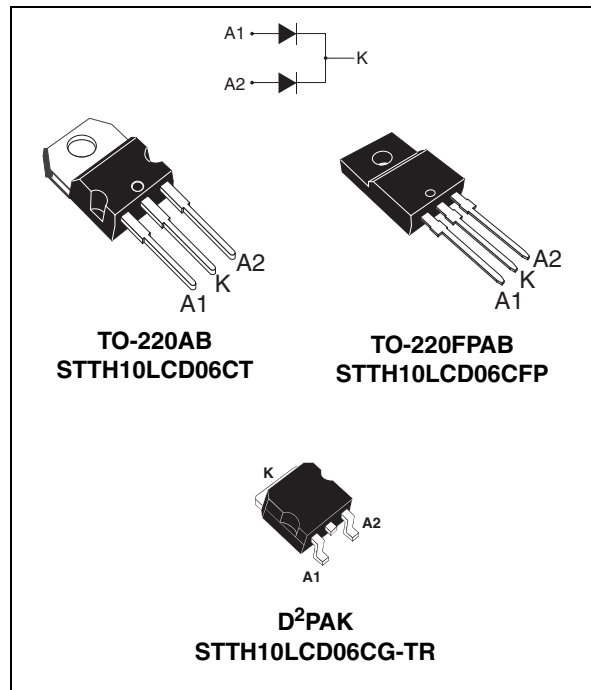

**Table 1. Device summary**

$I_{F(AV)}$	2 x 5A
$V_{RRM}$	600 V
$T_j$	175 °C
$V_F$ (typ)	1.25 V
$t_{rr}$ (max)	25 ns

# 1 Characteristics

**Table 2. Absolute ratings<sup>(1)</sup>**

Symbol	Parameter			Value	Unit	
V <sub>RRM</sub>	Repetitive peak reverse voltage			600	V	
I <sub>F(RMS)</sub>	Forward current rms			20	A	
I <sub>F(AV)</sub>	Average forward current, δ = 0.5	T <sub>c</sub> = 130 °C	TO-220AB, D <sup>2</sup> PAK	Per diode	5	A
				Per device	10	A
		T <sub>c</sub> = 100 °C	TO-220FPAB	Per diode	5	A
				Per device	10	A
I <sub>FSM</sub>	Surge non repetitive forward current	t <sub>p</sub> = 10 ms sinusoidal		60	A	
T <sub>stg</sub>	Storage temperature range			-65 to + 175	°C	
T <sub>j</sub>	Maximum operating junction temperature <sup>(2)</sup>			175	°C	

- Limiting values per diode at 25 °C, unless otherwise specified
- $\frac{dP_{tot}}{dT_j} < \frac{1}{R_{th(j-a)}}$  condition to avoid thermal runaway for a diode on its own heatsink

**Table 3. Thermal resistance**

Symbol	Parameter		Value	Unit
R <sub>th(j-c)</sub>	Junction to case(per diode)	TO-220AB, D <sup>2</sup> PAK	4.5	°C/W
		TO-220FPAB	7.5	

**Table 4. Static electrical characteristics**

Symbol	Parameter	Test conditions		Min.	Typ.	Max.	Unit
I <sub>R</sub> <sup>(1)</sup>	Reverse leakage current	T <sub>j</sub> = 25 °C	V <sub>R</sub> = V <sub>RRM</sub>			1	μA
		T <sub>j</sub> = 150 °C			5	50	
V <sub>F</sub> <sup>(2)</sup>	Forward voltage drop	T <sub>j</sub> = 25 °C	I <sub>F</sub> = 5 A			2	V
		T <sub>j</sub> = 150 °C			1.25	1.6	
		T <sub>j</sub> = 25 °C	I <sub>F</sub> = 10 A			2.35	
		T <sub>j</sub> = 150 °C			1.55	2	

- Pulse test: t<sub>p</sub> = 5 ms, δ < 2 %
- Pulse test: t<sub>p</sub> = 380 μs, δ < 2 %

To evaluate the conduction losses use the following equation:

$$P = 1.2 \times I_{F(AV)} + 0.08 \times I_{F(RMS)}^2$$

Table 5. Dynamic electrical characteristics

Symbol	Parameter	Test conditions	Min.	Typ.	Max.	Unit
$t_{rr}$	Reverse recovery time	$I_F = 0.5 \text{ A}$ , $I_{rr} = 0.25 \text{ A}$ , $I_R = 1 \text{ A}$ , $T_j = 25 \text{ }^\circ\text{C}$			25	ns
		$I_F = 1 \text{ A}$ , $di_F/dt = -50 \text{ A}/\mu\text{s}$ , $V_R = 30 \text{ V}$ , $T_j = 25 \text{ }^\circ\text{C}$		35	50	
$I_{RM}$	Reverse recovery current	$I_F = 5 \text{ A}$ , $di_F/dt = -50 \text{ A}/\mu\text{s}$ , $V_R = 400 \text{ V}$ , $T_j = 125 \text{ }^\circ\text{C}$		1.8	2.5	A
$t_{fr}$	Forward recovery time	$I_F = 5 \text{ A}$ , $di_F/dt = 100 \text{ A}/\mu\text{s}$ $V_{FR} = 1.1 \times V_{Fmax}$ , $T_j = 25 \text{ }^\circ\text{C}$			100	ns
$V_{FP}$	Forward recovery voltage	$I_F = 5 \text{ A}$ , $di_F/dt = 100 \text{ A}/\mu\text{s}$ $V_{FR} = 1.1 \times V_{Fmax}$ , $T_j = 25 \text{ }^\circ\text{C}$		5		V

Figure 1. Average forward power dissipation versus average forward current (per diode)

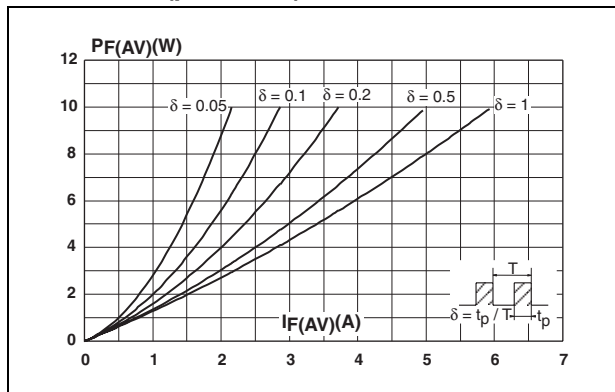

Figure 2. Forward voltage drop versus forward current (per diode)

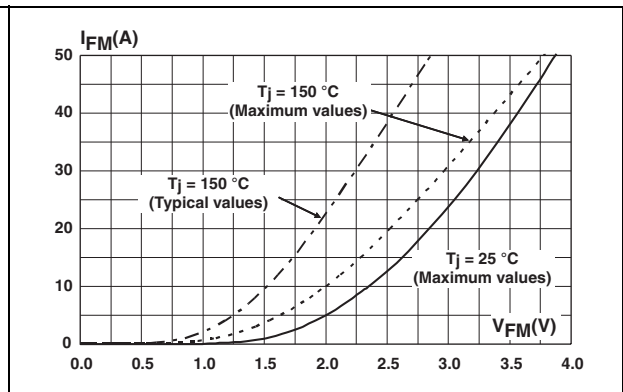

Figure 3. Relative variation of thermal impedance junction to case versus pulse duration (TO-220AB, D<sup>2</sup>PAK)

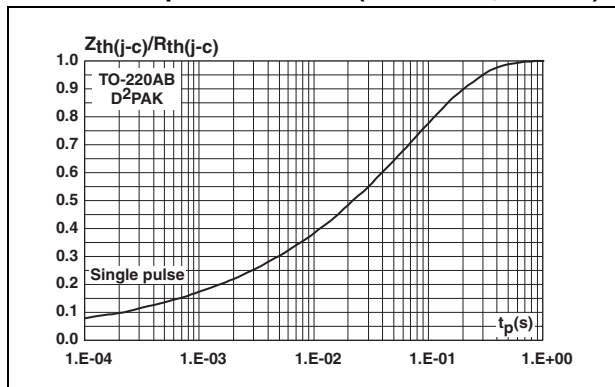
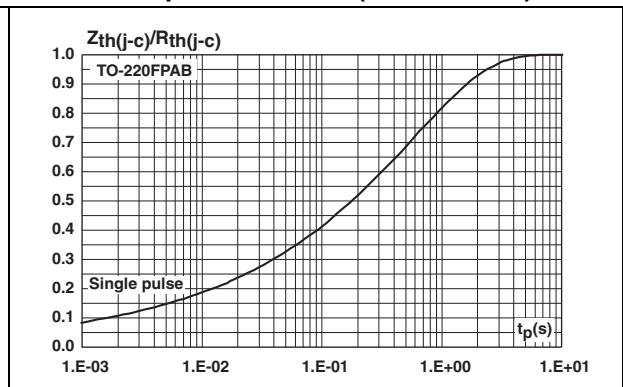
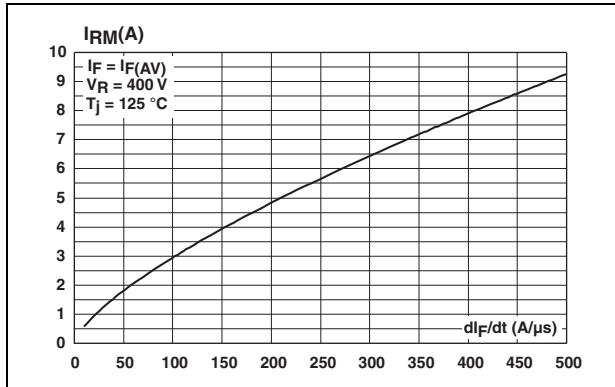

Figure 4. Relative variation of thermal impedance junction to case versus pulse duration (TO-220FPAB)



**Figure 5. Peak reverse recovery current versus  $di_F/dt$  (typical values, per diode)**



**Figure 6. Reverse recovery time versus  $di_F/dt$  (typical values, per diode)**

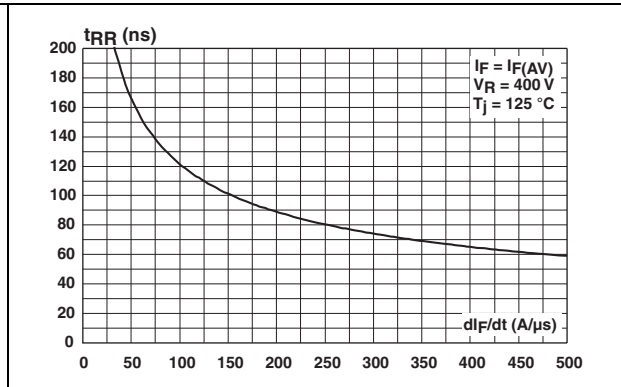

**Figure 7. Reverse recovery charges versus  $di_F/dt$  (typical values, per diode)**

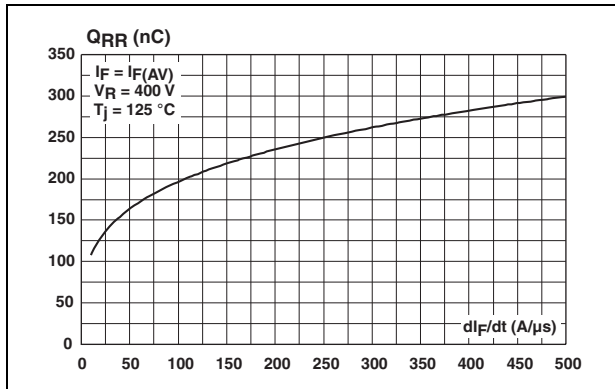

**Figure 8. Reverse recovery softness factor versus  $di_F/dt$  (typical values, per diode)**

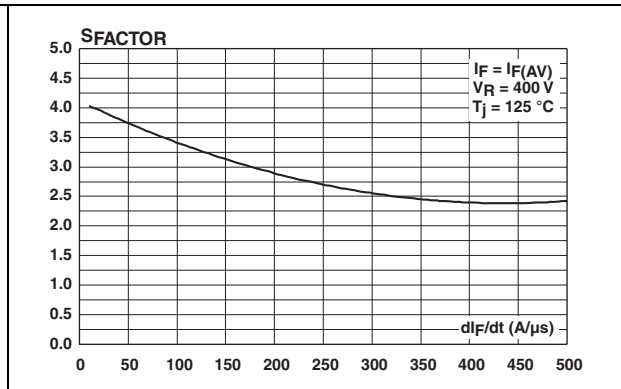

**Figure 9. Relative variations of dynamic parameters versus junction temperature**

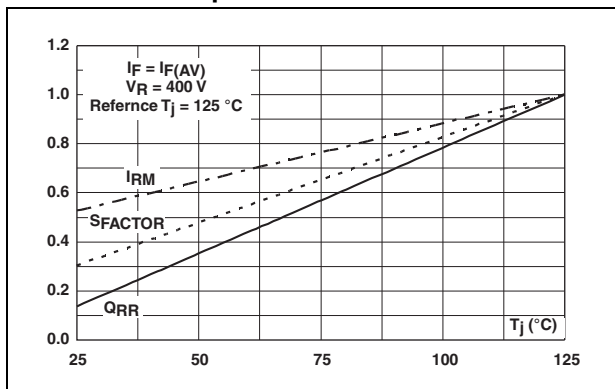

**Figure 10. Transient peak forward voltage versus  $di_F/dt$  (typical values, per diode)**

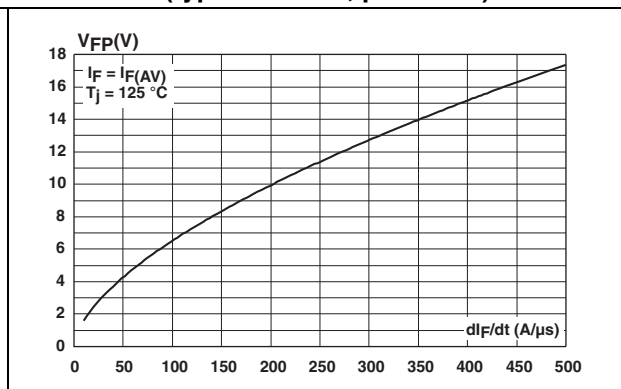

Figure 11. Forward recovery time versus  $di_F/dt$  (typical values, per diode) Figure 12. Junction capacitance versus reverse voltage applied (typical values, per diode)

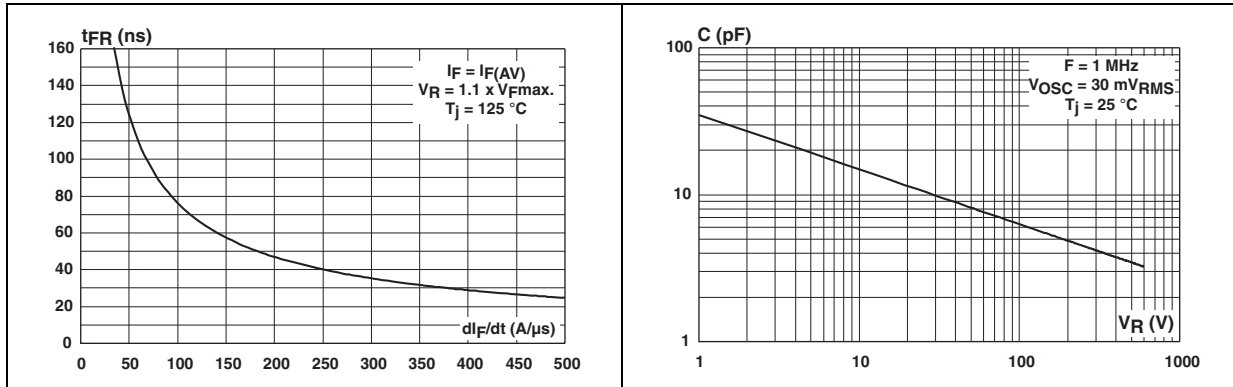
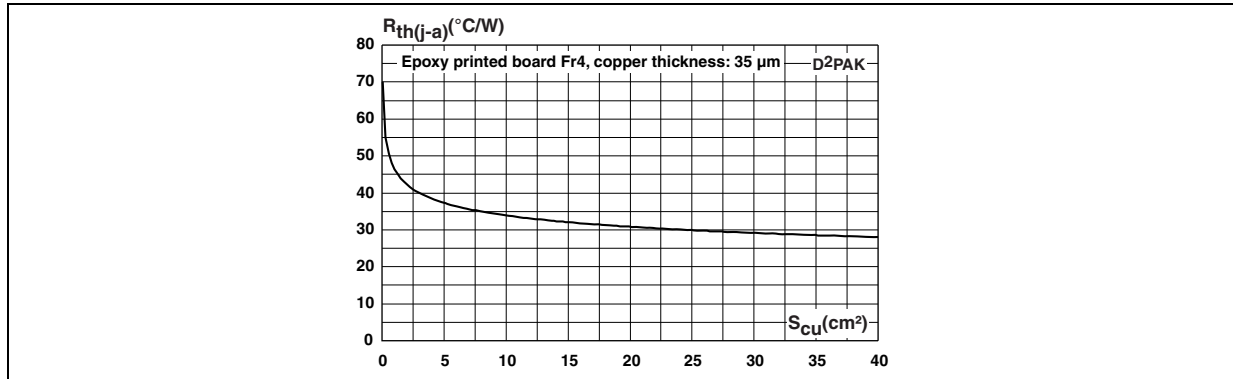

Figure 13. Thermal resistance junction to ambient versus copper surface under tab



## 2 Package information

- Epoxy meets UL94, V0
- Cooling method: by conduction (C)
- Recommended torque value: 0.4 to 0.6 N·m

In order to meet environmental requirements, ST offers these devices in different grades of ECOPACK® packages, depending on their level of environmental compliance. ECOPACK® specifications, grade definitions and product status are available at: [www.st.com](http://www.st.com). ECOPACK® is an ST trademark.

**Table 6. TO-220AB dimensions**

Ref.	Dimensions			
	Millimeters		Inches	
	Min.	Max.	Min.	Max.
A	4.40	4.60	0.173	0.181
C	1.23	1.32	0.048	0.051
D	2.40	2.72	0.094	0.107
E	0.49	0.70	0.019	0.027
F	0.61	0.88	0.024	0.034
F1	1.14	1.70	0.044	0.066
F2	1.14	1.70	0.044	0.066
G	4.95	5.15	0.194	0.202
G1	2.40	2.70	0.094	0.106
H2	10	10.40	0.393	0.409
L2	16.4 typ.		0.645 typ.	
L4	13	14	0.511	0.551
L5	2.65	2.95	0.104	0.116
L6	15.25	15.75	0.600	0.620
L7	6.20	6.60	0.244	0.259
L9	3.50	3.93	0.137	0.154
M	2.6 typ.		0.102 typ.	
Diam.	3.75	3.85	0.147	0.151

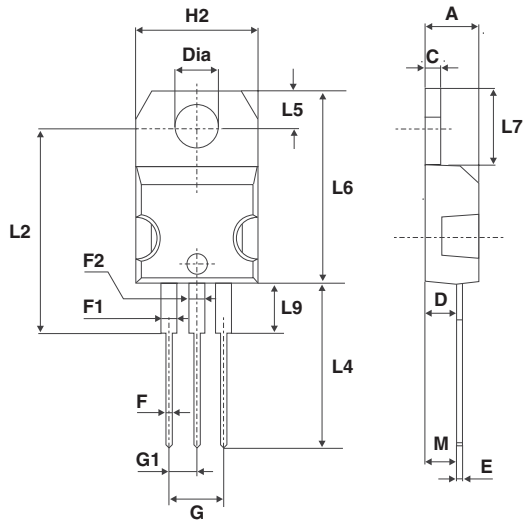
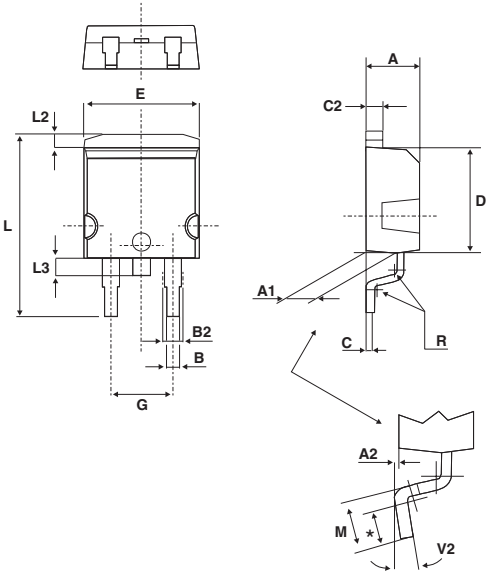

Table 7. TO-220FPAB dimensions

Ref.	Dimensions			
	Millimeters		Inches	
	Min.	Max.	Min.	Max.
A	4.4	4.6	0.173	0.181
B	2.5	2.7	0.098	0.106
D	2.5	2.75	0.098	0.108
E	0.45	0.70	0.018	0.027
F	0.75	1	0.030	0.039
F1	1.15	1.70	0.045	0.067
F2	1.15	1.70	0.045	0.067
G	4.95	5.20	0.195	0.205
G1	2.4	2.7	0.094	0.106
H	10	10.4	0.393	0.409
L2	16 Typ.		0.63 Typ.	
L3	28.6	30.6	1.126	1.205
L4	9.8	10.6	0.386	0.417
L5	2.9	3.6	0.114	0.142
L6	15.9	16.4	0.626	0.646
L7	9.00	9.30	0.354	0.366
Dia.	3.00	3.20	0.118	0.126

Table 8. D<sup>2</sup>PAK dimensions



\* FLAT ZONE NO LESS THAN 2mm

Ref.	Dimensions			
	Millimeters		Inches	
	Min.	Max.	Min.	Max.
A	4.40	4.60	0.173	0.181
A1	2.49	2.69	0.098	0.106
A2	0.03	0.23	0.001	0.009
B	0.70	0.93	0.027	0.037
B2	1.14	1.70	0.045	0.067
C	0.45	0.60	0.017	0.024
C2	1.23	1.36	0.048	0.054
D	8.95	9.35	0.352	0.368
E	10.00	10.40	0.393	0.409
G	4.88	5.28	0.192	0.208
L	15.00	15.85	0.590	0.624
L2	1.27	1.40	0.050	0.055
L3	1.40	1.75	0.055	0.069
M	2.40	3.20	0.094	0.126
R	0.40 typ.		0.016 typ.	
V2	0°	8°	0°	8°



### 3 Ordering information

**Table 9. Ordering information**

Order code	Marking	Package	Weight	Base qty.	Delivery mode
STTH10LCD06CT	STTH10LCD06CT	TO-220AB	2.23 g	50	Tube
STTH10LCD06CG-TR	STTH10LCD06CG	D <sup>2</sup> PAK	1.48 g	1000	Tape and reel
STTH10LCD06CFP	STTH10LCD06C	TO-220FPAB	2.04 g	50	Tube

### 4 Revision history

**Table 10. Document revision history**

Date	Revision	Changes
15-Jul-2009	1	First issue.
17-Jan-2011	2	Updated dimensions and graphic in <a href="#">Table 7</a> .
07-Apr-2011	3	Added (per diode) in <a href="#">Table 3</a> .

**Please Read Carefully:**

Information in this document is provided solely in connection with ST products. STMicroelectronics NV and its subsidiaries ("ST") reserve the right to make changes, corrections, modifications or improvements, to this document, and the products and services described herein at any time, without notice.

All ST products are sold pursuant to ST's terms and conditions of sale.

Purchasers are solely responsible for the choice, selection and use of the ST products and services described herein, and ST assumes no liability whatsoever relating to the choice, selection or use of the ST products and services described herein.

No license, express or implied, by estoppel or otherwise, to any intellectual property rights is granted under this document. If any part of this document refers to any third party products or services it shall not be deemed a license grant by ST for the use of such third party products or services, or any intellectual property contained therein or considered as a warranty covering the use in any manner whatsoever of such third party products or services or any intellectual property contained therein.

**UNLESS OTHERWISE SET FORTH IN ST'S TERMS AND CONDITIONS OF SALE ST DISCLAIMS ANY EXPRESS OR IMPLIED WARRANTY WITH RESPECT TO THE USE AND/OR SALE OF ST PRODUCTS INCLUDING WITHOUT LIMITATION IMPLIED WARRANTIES OF MERCHANTABILITY, FITNESS FOR A PARTICULAR PURPOSE (AND THEIR EQUIVALENTS UNDER THE LAWS OF ANY JURISDICTION), OR INFRINGEMENT OF ANY PATENT, COPYRIGHT OR OTHER INTELLECTUAL PROPERTY RIGHT.**

**UNLESS EXPRESSLY APPROVED IN WRITING BY AN AUTHORIZED ST REPRESENTATIVE, ST PRODUCTS ARE NOT RECOMMENDED, AUTHORIZED OR WARRANTED FOR USE IN MILITARY, AIR CRAFT, SPACE, LIFE SAVING, OR LIFE SUSTAINING APPLICATIONS, NOR IN PRODUCTS OR SYSTEMS WHERE FAILURE OR MALFUNCTION MAY RESULT IN PERSONAL INJURY, DEATH, OR SEVERE PROPERTY OR ENVIRONMENTAL DAMAGE. ST PRODUCTS WHICH ARE NOT SPECIFIED AS "AUTOMOTIVE GRADE" MAY ONLY BE USED IN AUTOMOTIVE APPLICATIONS AT USER'S OWN RISK.**

Resale of ST products with provisions different from the statements and/or technical features set forth in this document shall immediately void any warranty granted by ST for the ST product or service described herein and shall not create or extend in any manner whatsoever, any liability of ST.

ST and the ST logo are trademarks or registered trademarks of ST in various countries.

Information in this document supersedes and replaces all information previously supplied.

The ST logo is a registered trademark of STMicroelectronics. All other names are the property of their respective owners.

© 2011 STMicroelectronics - All rights reserved

STMicroelectronics group of companies

Australia - Belgium - Brazil - Canada - China - Czech Republic - Finland - France - Germany - Hong Kong - India - Israel - Italy - Japan - Malaysia - Malta - Morocco - Philippines - Singapore - Spain - Sweden - Switzerland - United Kingdom - United States of America

[www.st.com](http://www.st.com)