

THIS DOCUMENT IS THE PROPERTY OF
KEYSTONE ELECTRONICS CORP. AND
SHALL NOT BE REPRODUCED, DISTRIBUTED
OR USED AS A BASIS FOR MANUFACTURE
WITHOUT PRIOR WRITTEN PERMISSION
FROM KEYSTONE ELECTRONICS CORP.

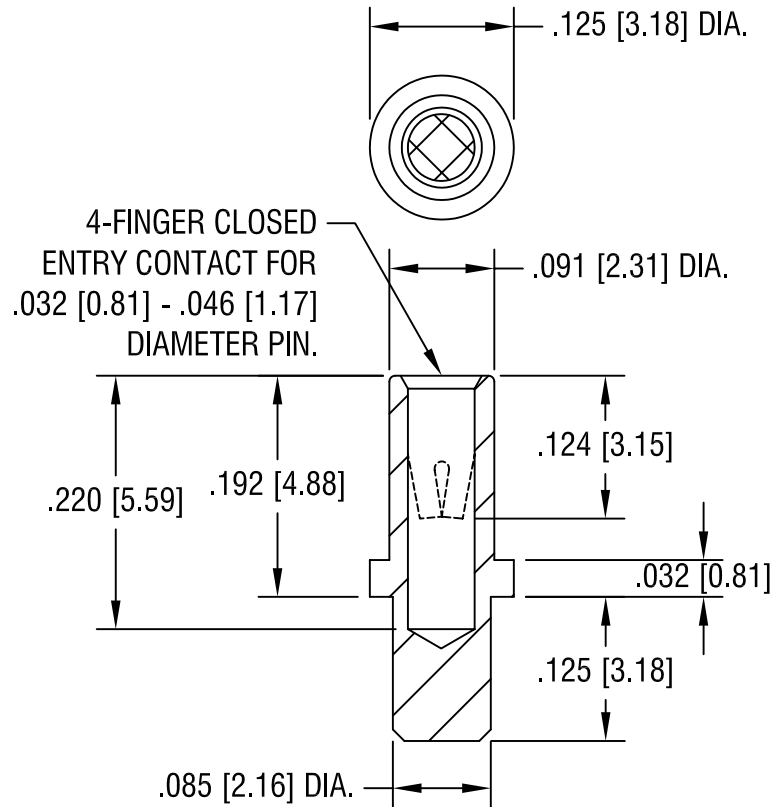

NOTES:

1. SPRING CONTACT:
MAT'L - BERYLLIUM COPPER
FINISH - GOLD PLATE

BODY:
MAT'L - BRASS
FINISH - TIN/LEAD PLATE
2. MOUNTING HOLE DIA.: .089 [2.26]

TOLERANCE ON DIAMETERS: $\pm .002$

KEYSTONE ELECTRONICS CORP.			
ASTORIA, N.Y. 11105-2017			
PART NAME			
MICRO JACK, SOLDER MOUNT			
MATERIAL			
AS NOTED			
FINISH		DRN BY	DATE
AS NOTED		BOONE	2.26.07
		APP'D	SCALE
		LN	6X
TOLERANCES	INCH [MM]	CODE	DWG NO.
DECIMAL	$\pm .005$ [± 0.15]	C/M	1679
ANGULAR	$\pm 1^\circ$		
UNLESS OTHERWISE SPECIFIED			

DATE	DESCRIPTION	REV.